

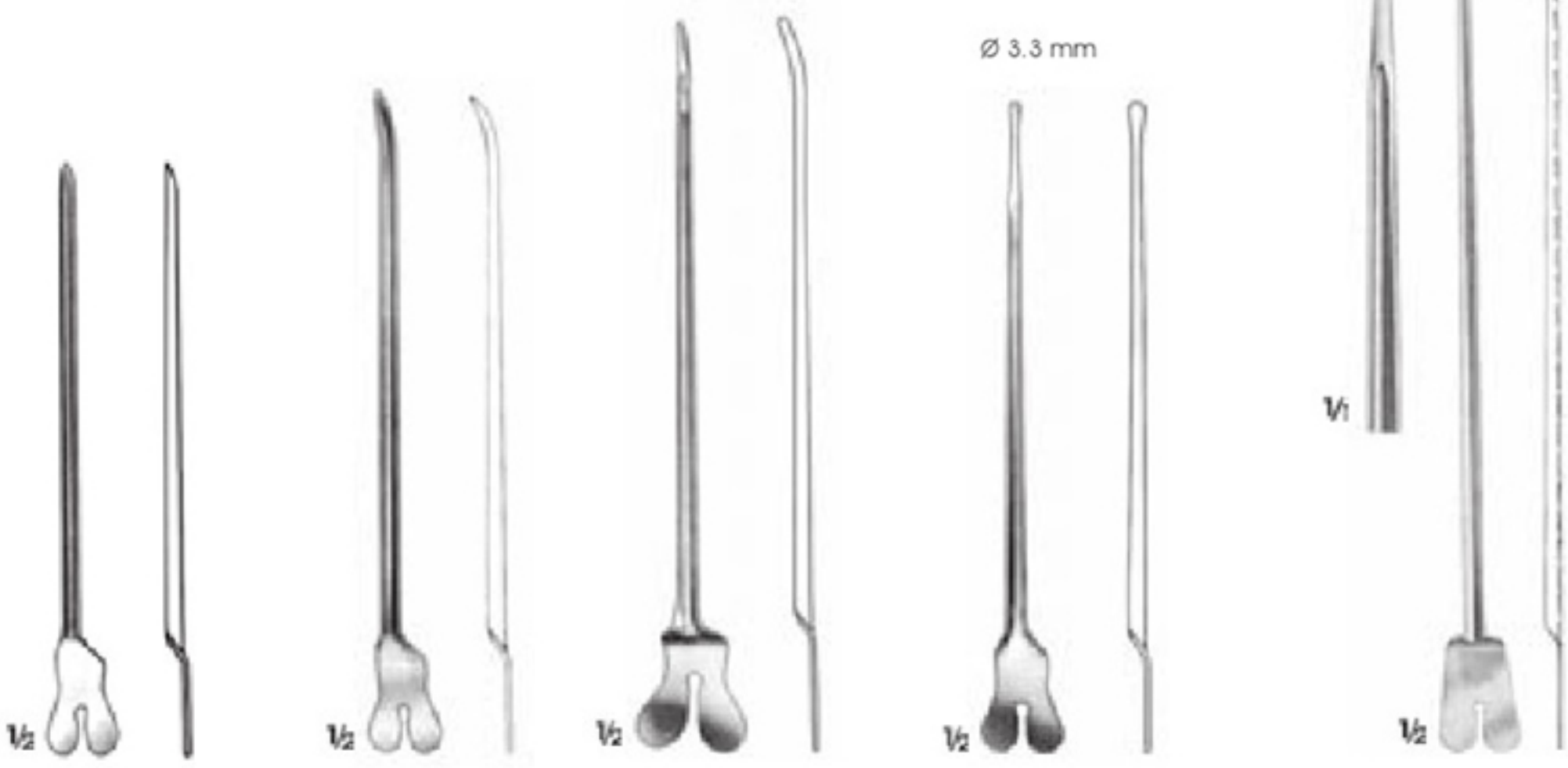

Probes, Suctions, Trocars And Biopsy Needles

Sonden, Saugen, Trokaren und Biopsie-Nadeln

Ø 3.5 mm



EM-09-1353-01 13 cm  
EM-09-1353-02 14.5 cm  
EM-09-1353-03 16 cm  
Directors

DOYEN  
EM-09-1354  
Director  
14.5 cm

NELATON  
EM-09-1355  
Director  
16 cm

Ø 3.3 mm  
EM-09-1356  
Director with tip  
14 cm

BRODIE  
EM-09-1357  
Director with tip  
20 cm

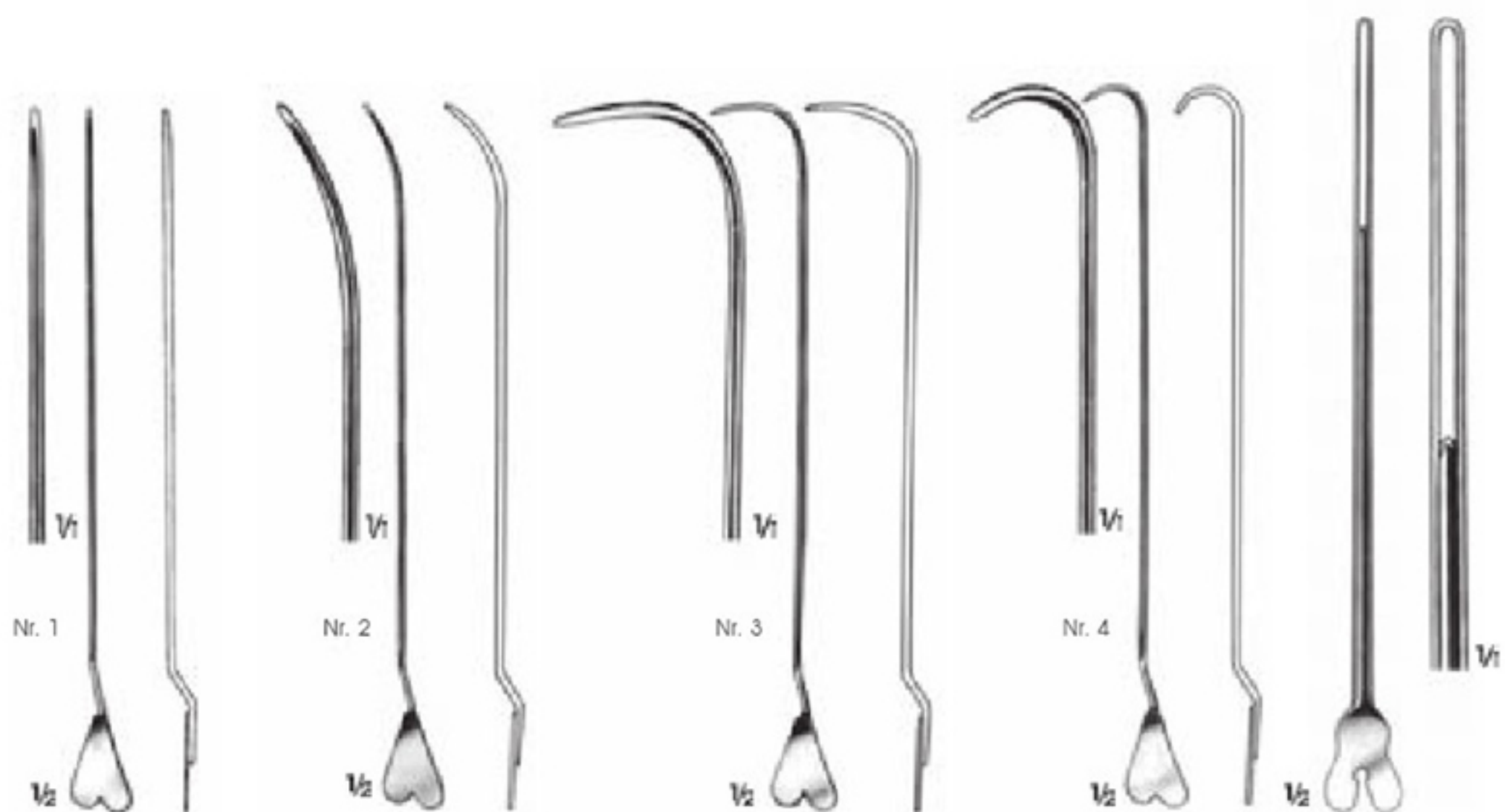

LOCKHART-MUMMERY  
EM-09-1358-01 Nr. 1 Straight  
EM-09-1358-02 Nr. 2 45° Curved  
EM-09-1358-03 Nr. 3 90° Curved  
EM-09-1358-04 Nr. 4 Curved  
Fistula probes  
16.5 cm

EM-09-1359  
Director with wire  
loop, malleable  
19 cm



∅ 2.0 mm



∅ 1.5 mm



1/2



Diameter of tip

1 mm	1.5 mm	2 mm	Length
EM-09-1363-01	EM-09-1363-08	EM-09-1363-15	13 cm
EM-09-1363-02	EM-09-1363-09	EM-09-1363-16	14.5 cm
EM-09-1363-03	EM-09-1363-10	EM-09-1363-17	16 cm
EM-09-1363-04	EM-09-1363-11	EM-09-1363-18	18 cm
EM-09-1363-05	EM-09-1363-12	EM-09-1363-19	20 cm
EM-09-1363-06	EM-09-1363-13	EM-09-1363-20	25 cm
EM-09-1363-07	EM-09-1363-14	EM-09-1363-21	30 cm

EM-09-1360-01 13 cm  
EM-09-1360-02 14.5 cm  
EM-09-1360-03 16 cm  
EM-09-1360-04 18 cm  
EM-09-1360-05 20 cm  
Myrtle leaf probes

EM-09-1361  
Myrtle leaf probe  
14.5 cm

EM-09-1362-01 ∅ 2.5 mm  
14.5 cm  
EM-09-1362-02 ∅ 2.5 mm  
16 cm  
EM-09-1362-03 ∅ 3.0 mm  
20 cm  
Probes with eye

EM-09-1363-01 - 1363-21  
Probes

∅ 3.5 mm

∅ 4 mm

∅ 2.0 mm

1/2



EM-09-1364  
12.5 cm

∅ 1.2 mm



1/2

EM-09-1365  
Sinus probe  
15 cm

∅ 3 mm



1/2

EM-09-1366  
Double ended probe,  
malleable, with hole  
19 cm



EM-09-1367  
J 038.01 30 cm  
Double ended probes,  
malleable, with hole

1/4

EM-09-1368  
Double ended probe,  
malleable  
40 cm

1/3



EM-09-1369  
Probe  
30 cm

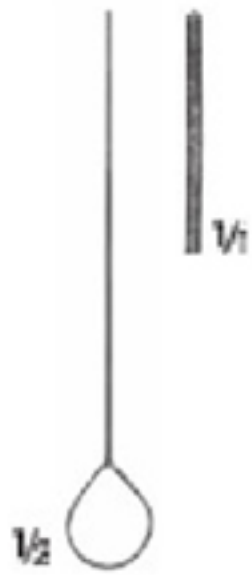

KINGS'S COLLEGE HOSPITAL  
EM-09-1370-01  
Cotton applicator  
Rough, spiral end  
9 cm

∅ 0.8 mm



STACKE  
EM-09-1371  
Probe  
Silver  
10 cm



KINGS'S COLLEGE HOSPITAL  
EM-09-1370-02  
Sert burgulu  
Rough, spiral end  
13.5 cm



CAWTHORNE  
EM-09-1370-03  
Probe  
Flattened end silver  
14 cm



BOWMAN  
EM-09-1372-01 ∅ 0.7 + 0.8 mm  
EM-09-1372-02 ∅ 0.9 + 1.1 mm  
EM-09-1372-03 ∅ 1.3 + 1.4 mm  
EM-09-1372-04 ∅ 1.5 + 1.6 mm  
EM-09-1372-05 ∅ 1.8 + 1.9 mm  
Probes  
Silver  
13 cm

∅ 0.9 mm

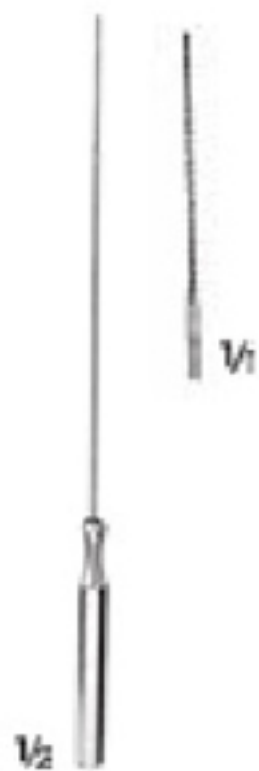

BUCK  
EM-09-1373  
Cotton applicator  
Rough, spiral end  
12 cm

∅ 1.4 mm



EM-09-1374  
Probe  
16 cm

∅ 0.1 mm



SEIFFERT  
EM-09-1375  
Probe  
Silver  
19.5 cm

∅ 1.5 mm



KILLIAN  
EM-09-1376  
Probe  
16.5 cm



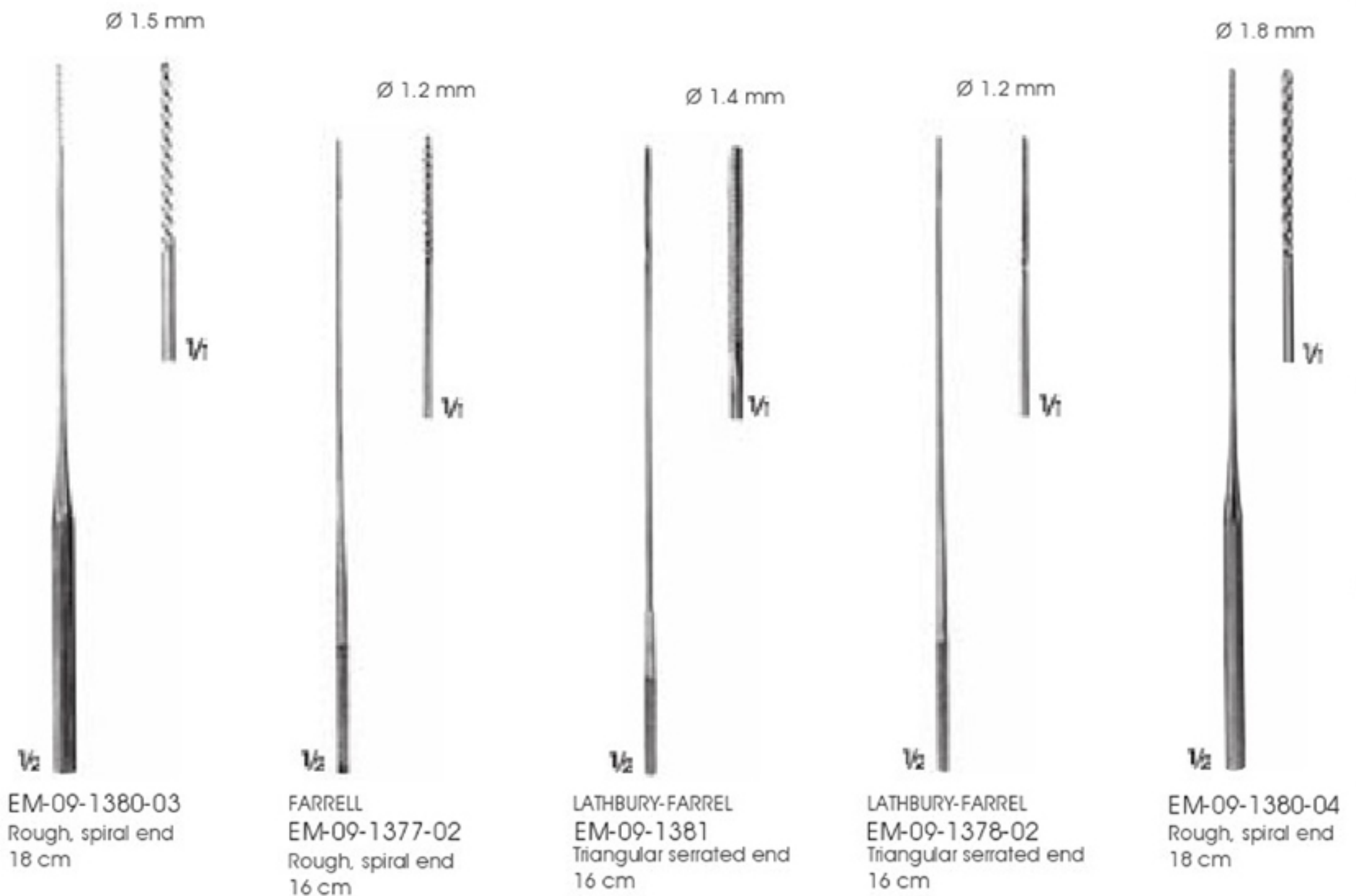
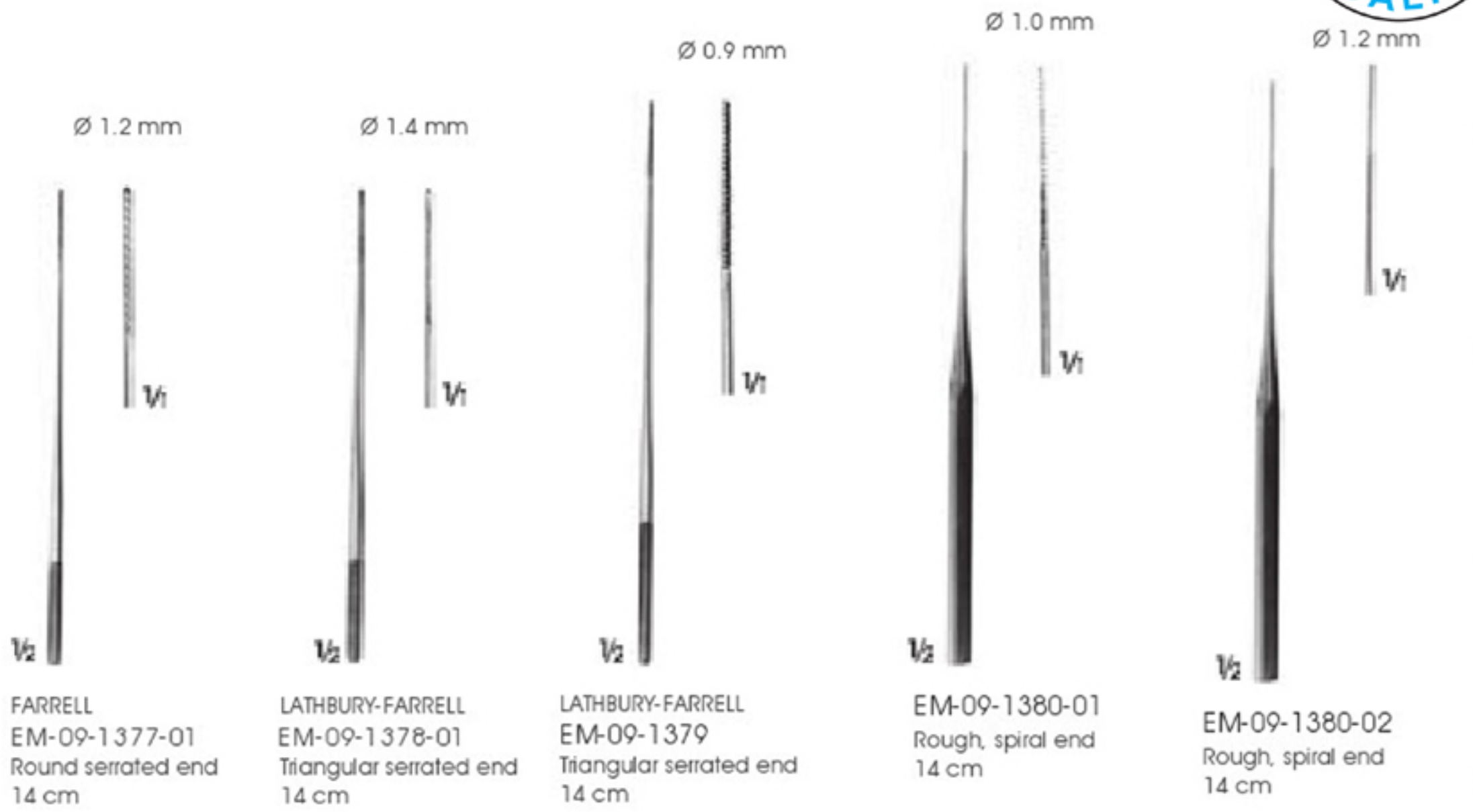

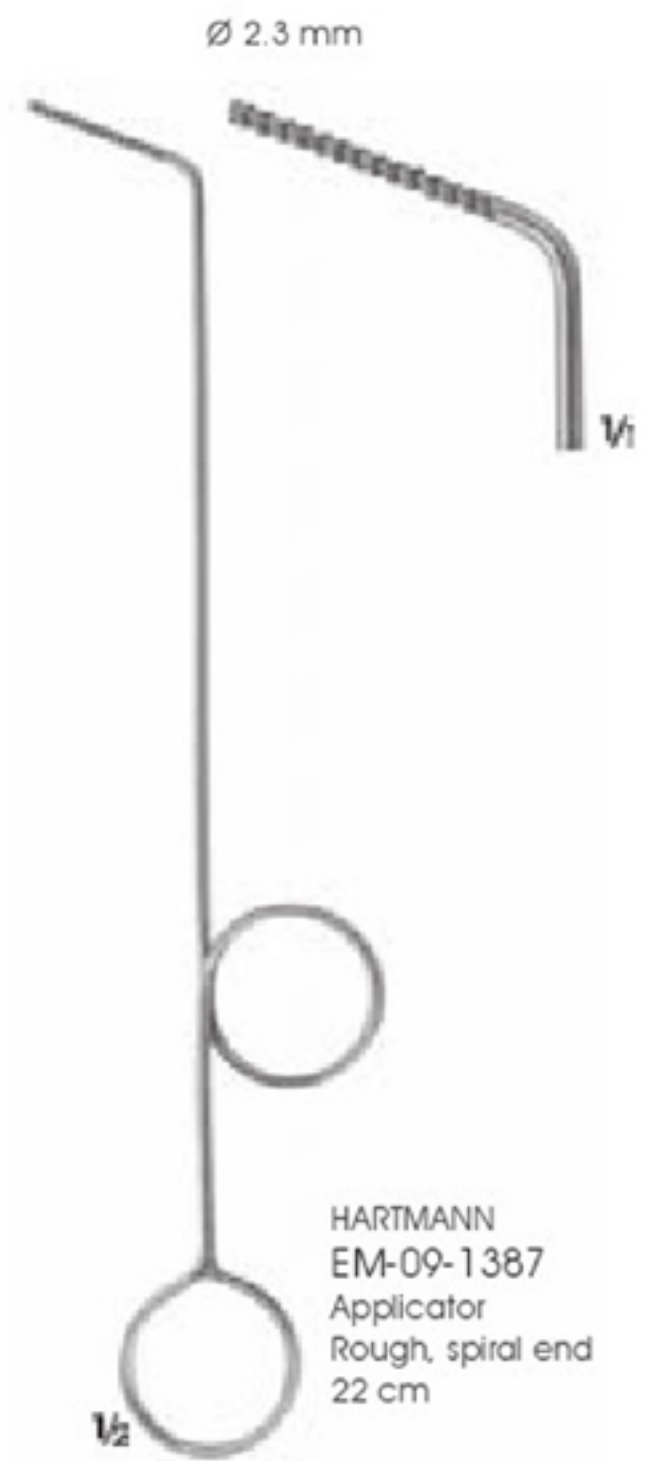



FERGUSSON

Working length	11 cm	13 cm	16 cm	20 cm	
Total Length	18 cm	21.5 cm	24.5 cm	28 cm	Ø
	EM-09-1388-01	EM-09-1388-07	EM-09-1388-13	EM-09-1388-19	1.5 mm
	EM-09-1388-02	EM-09-1388-08	EM-09-1388-14	EM-09-1388-20	2.0 mm
	EM-09-1388-03	EM-09-1388-09	EM-09-1388-15	EM-09-1388-21	2.5 mm
	EM-09-1388-04	EM-09-1388-10	EM-09-1388-16	EM-09-1388-22	3.0 mm
	EM-09-1388-05	EM-09-1388-11	EM-09-1388-17	EM-09-1388-23	4.0 mm
	EM-09-1388-06	EM-09-1388-12	EM-09-1388-18	EM-09-1388-24	5.0 mm

With finger cut-off and stylet  
Thumb piece 90° to curve, With LUER hub

Olive  
Ø 6-9 mm



FERGUSSON  
EM-09-1389 Ø 4 mm  
Isolated, with finger cut-off and stylet,  
thumb piece 90° to curve, with LUER  
hub  
18 cm

Olive  
Ø 6-9 mm



FRAZIER  
EM-09-1390-01 Ø 3 mm  
EM-09-1390-02 Ø 5 mm  
With finger cut-off and stylet  
Thumb piece 90° to curve,  
with LUER hub  
18 cm



FRAZIER  
EM-09-1391-01 Ø 2.3 mm  
EM-09-1391-02 Ø 2.7 mm  
EM-09-1391-03 Ø 3.4 mm  
EM-09-1391-04 Ø 4.0 mm  
With finger cut-off and stylet  
Thumb piece 90° to curve,  
with LUER hub  
11 cm







**ZOELLNER**  
 EM-09-1392-01 Ø 26 swg, Ø 0.4 mm  
 EM-09-1392-02 Ø 24 swg, Ø 0.5 mm  
 EM-09-1392-03 Ø 22 swg, Ø 0.7 mm  
 EM-09-1392-04 Ø 20 swg, Ø 1.0 mm  
 EM-09-1392-05 Ø 18 swg, Ø 1.2 mm  
 Detachable ends fitting to J 377.01 and J 378.00  
 Package of 10 pieces



**VERHOEVEN**  
 EM-09-1393-01 Ø 24 swg, Ø 0.5 mm  
 EM-09-1393-02 Ø 22 swg, Ø 0.7 mm  
 EM-09-1393-03 Ø 20 swg, Ø 1.0 mm  
 EM-09-1393-04 Ø 18 swg, Ø 1.2 mm  
 EM-09-1393-05 Ø 16 swg, Ø 1.5 mm  
 Suction cannulae with Luer cone  
 10 cm

Olive  
 Ø 7 mm



**HOUSE**  
 EM-09-1394  
 Suction adapter with  
 finger cut-off, LUER  
 cone, LUER hub  
 5.5 cm



Olive  
 Ø 6-9 mm

**PLESTER**  
 EM-09-1395-01 Ø 1.5 mm  
 EM-09-1395-02 Ø 2.0 mm  
 EM-09-1395-03 Ø 2.5 mm  
 EM-09-1395-04 Ø 3.0 mm  
 With finger cut-off and stylet,  
 thumb piece parallel to curve, with  
 LUER hub  
 19.5 cm

Ø 4 mm



Olive  
 Ø 9 mm

**ADSON**  
 EM-09-1396  
 Parmak kumandali  
 With finger cut-off  
 19 cm

Ø 3 mm



Olive  
 Ø 8 mm

**ADSON**  
 EM-09-1397  
 With finger cut-off  
 and stylet  
 16.5 cm



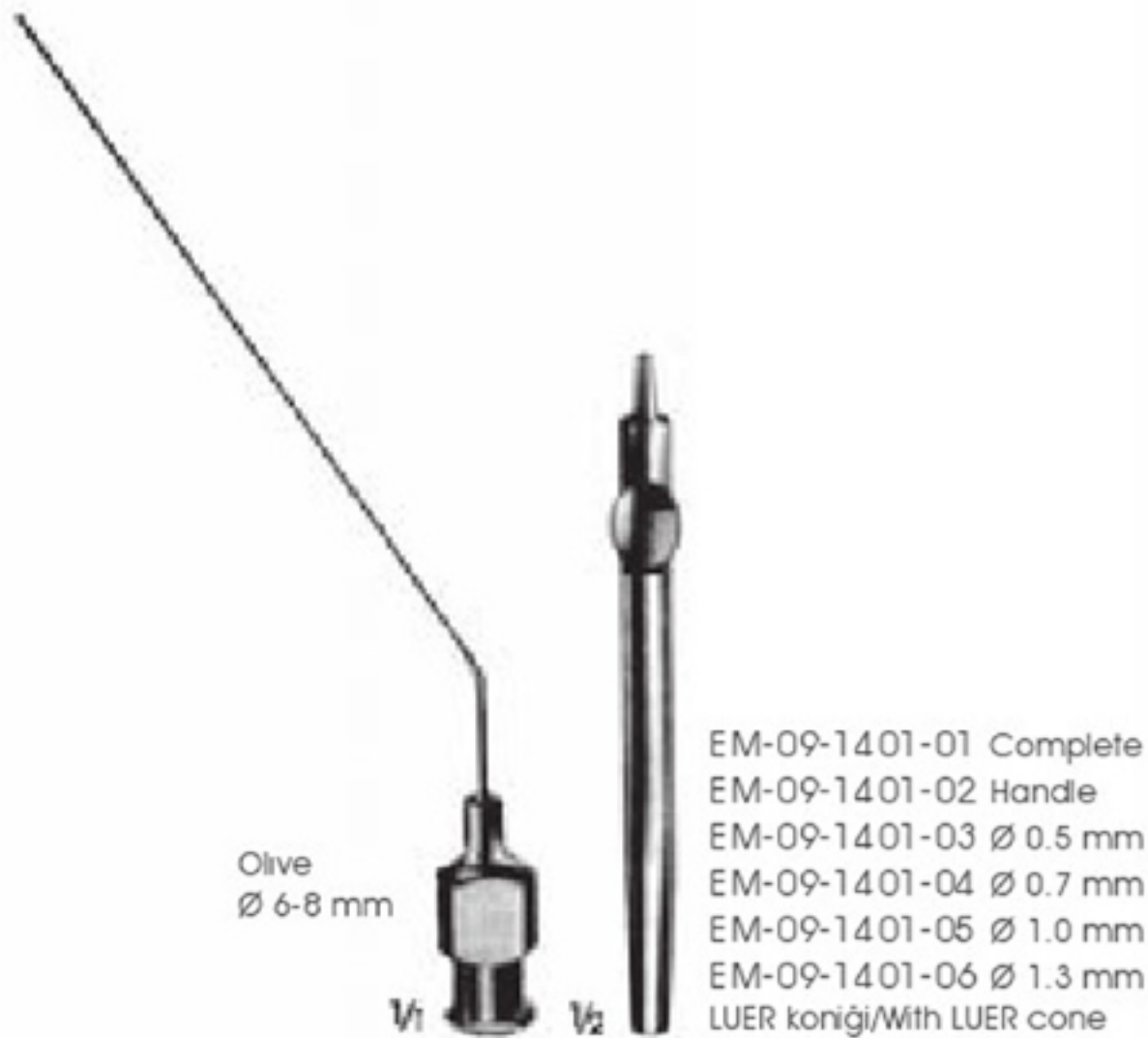

Ø 2.5 mm



Olive  
Ø 8 mm

**BARRON**  
EM-09-1403-01 Ø 1.3 mm  
EM-09-1403-02 Ø 2 mm  
With finger cut-off and stylet  
16 cm



Olive  
Ø 8 mm

**BELLUCCI**  
EM-09-1404 Complete  
With finger cut-off and stylet  
EM-09-1405-01 Ø 0.5 mm  
EM-09-1405-02 Ø 0.7 mm  
EM-09-1405-03 Ø 1.0 mm  
15.5 cm



Olive  
Ø 8 mm

**ZOELLNER**  
EM-09-1406  
Suction cannula only,  
fitting to the detachable  
ends J 032.01 ve J 032.08  
18 cm



Ø 1.75 mm

Ø 0.3 mm

Olive  
Ø 6-9 mm

**WULLSTEIN**  
EM-09-1407  
Suction tube  
conical, silver  
With LUER hub  
16 cm



Olive  
Ø 8 mm

**WULLSTEIN**  
EM-09-1408-01 Ø 1.5 mm  
EM-09-1408-02 Ø 2.0 mm  
Silver  
With LUER hub  
16 cm



Olive  
Ø 8 mm

**SCHUKNECHT**  
EM-09-1409-01 Ø 1 mm  
EM-09-1409-02 Ø 0.5 mm  
Suction cannulae  
13 cm

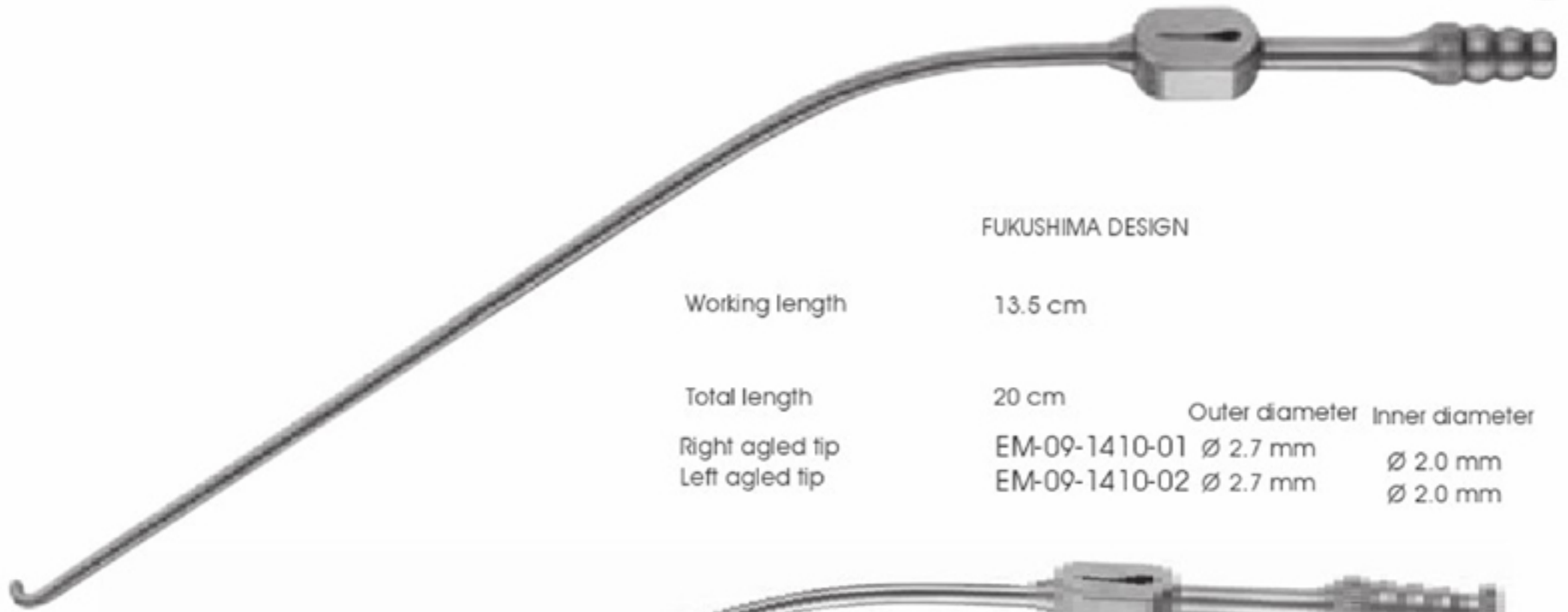

FUKUSHIMA DESIGN

Working length	13.5 cm		
Total length	20 cm	Outer diameter	Inner diameter
Right angled tip	EM-09-1410-01	∅ 2.7 mm	∅ 2.0 mm
Left angled tip	EM-09-1410-02	∅ 2.7 mm	∅ 2.0 mm

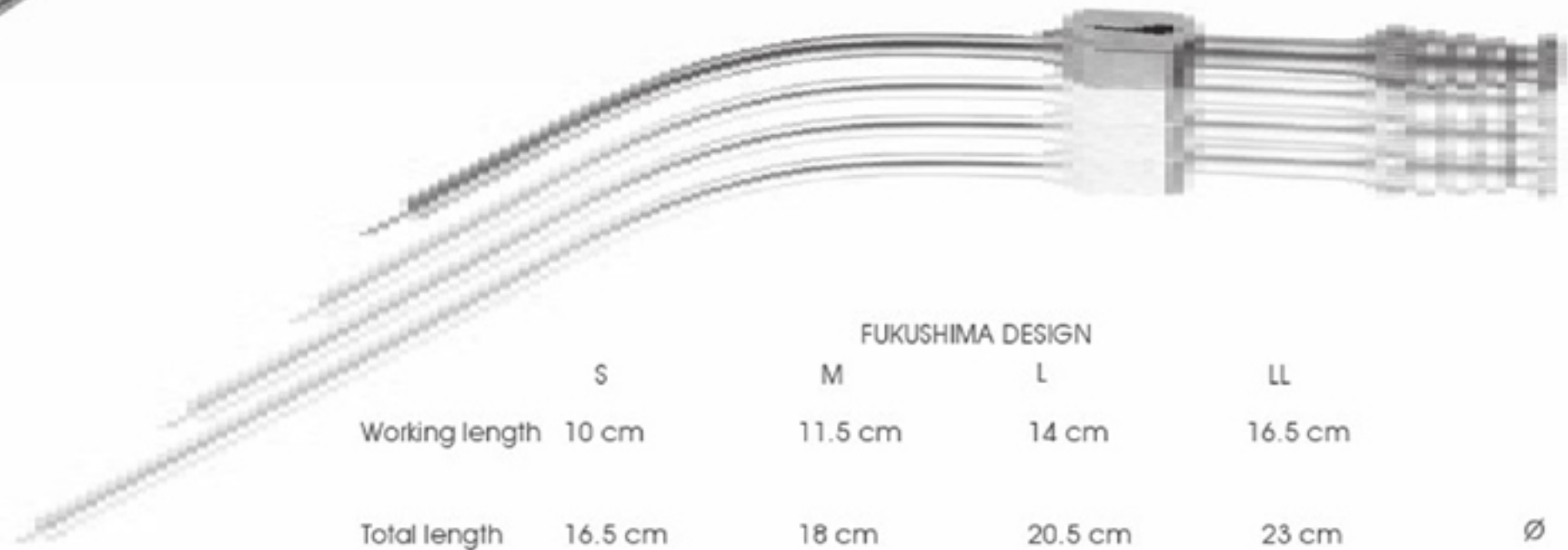

FUKUSHIMA DESIGN

	S	M	L	LL	
Working length	10 cm	11.5 cm	14 cm	16.5 cm	

Total length	16.5 cm	18 cm	20.5 cm	23 cm	∅
--------------	---------	-------	---------	-------	---

EM-09-1411-01	EM-09-1411-09	EM-09-1411-17	EM-09-1411-25	1.0 mm	3 Fr
EM-09-1411-02	EM-09-1411-10	EM-09-1411-18	EM-09-1411-26	1.4 mm	4 Fr
EM-09-1411-03	EM-09-1411-11	EM-09-1411-19	EM-09-1411-27	1.7 mm	5 Fr
EM-09-1411-04	EM-09-1411-12	EM-09-1411-20	EM-09-1411-28	2.0 mm	6 Fr
EM-09-1411-05	EM-09-1411-13	EM-09-1411-21	EM-09-1411-29	2.3 mm	7 Fr
EM-09-1411-06	EM-09-1411-14	EM-09-1411-22	EM-09-1411-30	2.7 mm	8 Fr
EM-09-1411-07	EM-09-1411-15	EM-09-1411-23	EM-09-1411-31	3.0 mm	9 Fr
EM-09-1411-08	EM-09-1411-16	EM-09-1411-24	EM-09-1411-31	4.0 mm	12 Fr

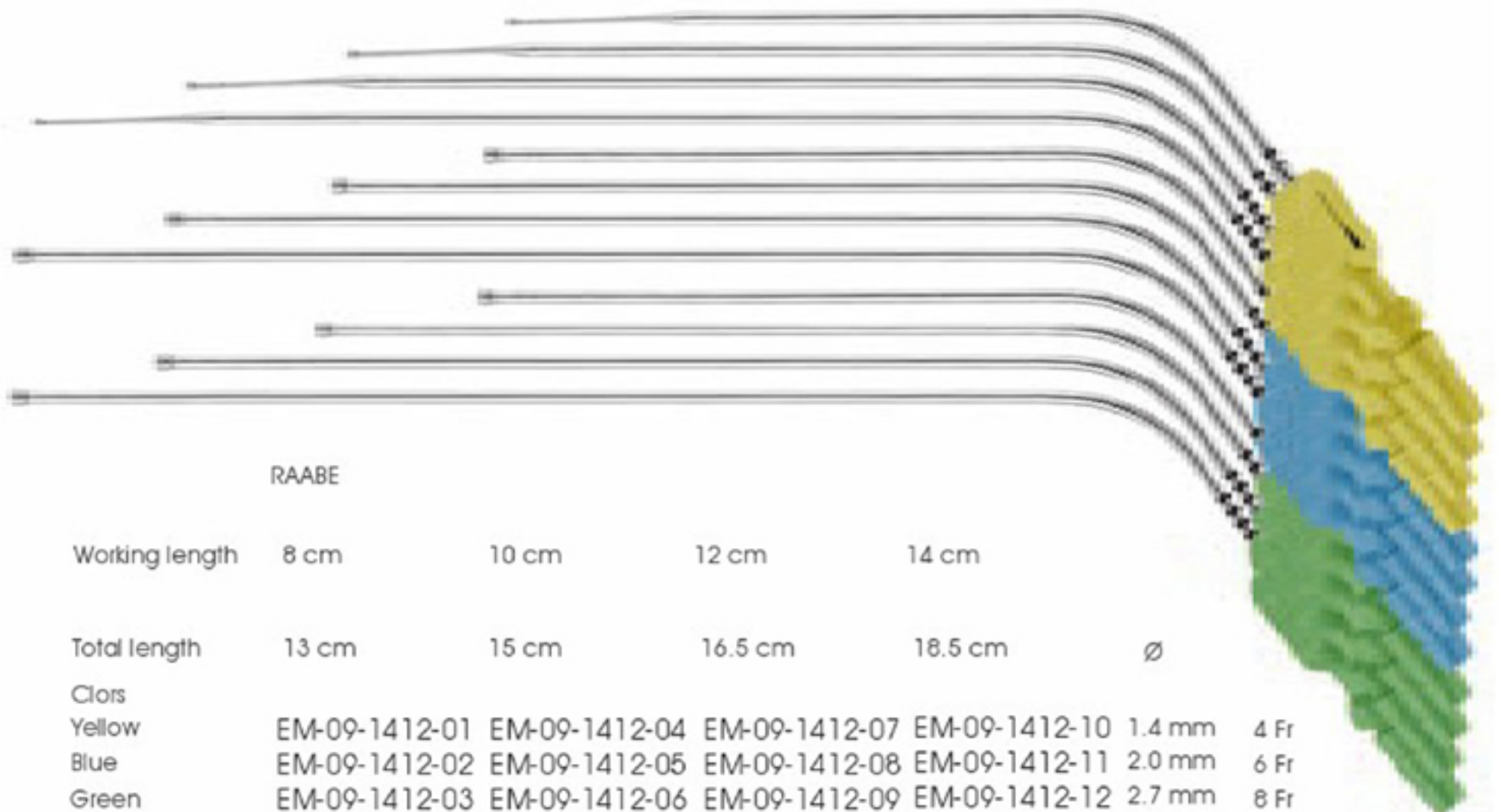

RAABE

Working length	8 cm	10 cm	12 cm	14 cm	
Total length	13 cm	15 cm	16.5 cm	18.5 cm	∅

Clors						
Yellow	EM-09-1412-01	EM-09-1412-04	EM-09-1412-07	EM-09-1412-10	1.4 mm	4 Fr
Blue	EM-09-1412-02	EM-09-1412-05	EM-09-1412-08	EM-09-1412-11	2.0 mm	6 Fr
Green	EM-09-1412-03	EM-09-1412-06	EM-09-1412-09	EM-09-1412-12	2.7 mm	8 Fr



EM-09-1413  
Parmak kumandalı ve  
temizleme telli  
With finger cut-off and stylet

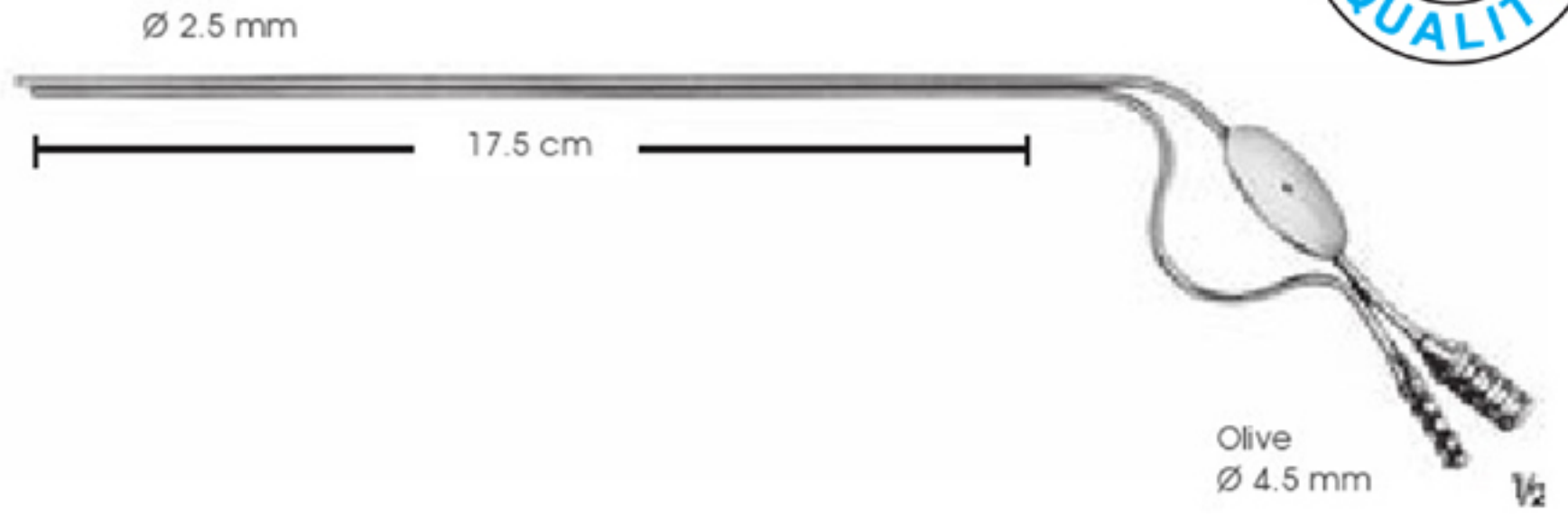

EM-09-1414-01 Ø 2.0 mm  
EM-09-1414-02 Ø 2.5 mm  
EM-09-1414-03 Ø 3.0 mm  
With finger cut-off, thumb piece 90° to curve  
25 cm



HOUSE  
EM-09-1415-01 Ø 0.9 - 0.7 mm  
EM-09-1415-02 Ø 1.2 - 0.9 mm  
EM-09-1415-03 Ø 1.5 - 1.2 mm  
With finger cut-off and stylet

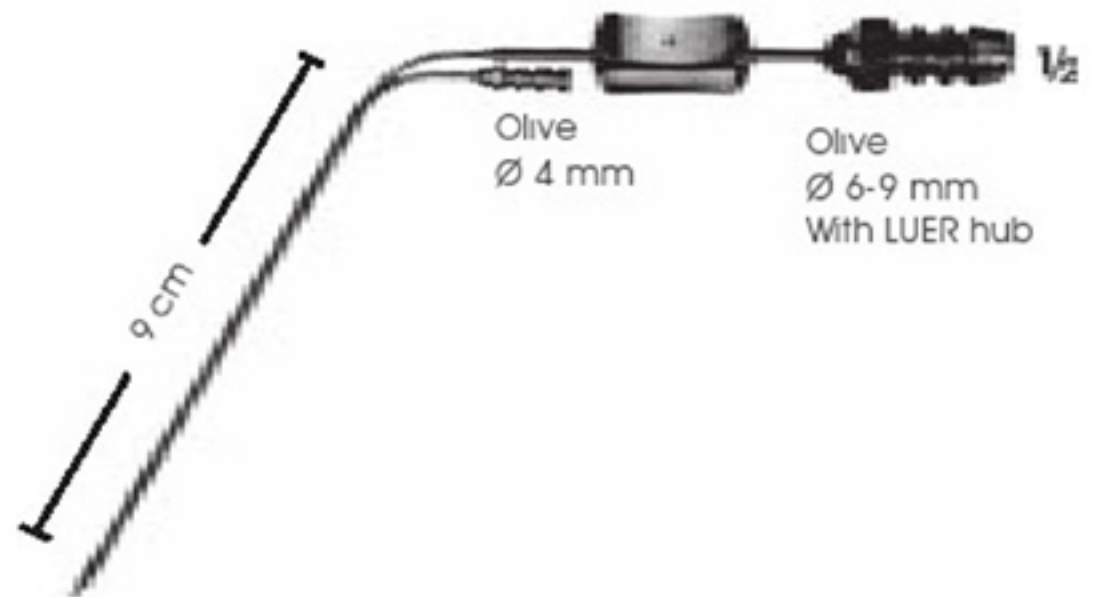

EM-09-1416-01 4 mm  
EM-09-1416-02 5 mm  
Suction raspatories, sharp  
bayonet-shaped  
20 cm



LANDOLT  
EM-09-1417 Wide 3.2 mm  
Dissecting suction tube for hypophysectomie  
and ENT, sharp angled point  
20 cm





EM-09-1418  
Tip wide 6.5 mm  
Nasal suction tube, with LUER hub  
18 cm



GORNEY  
EM-09-1419  
Suction dissector  
18 cm

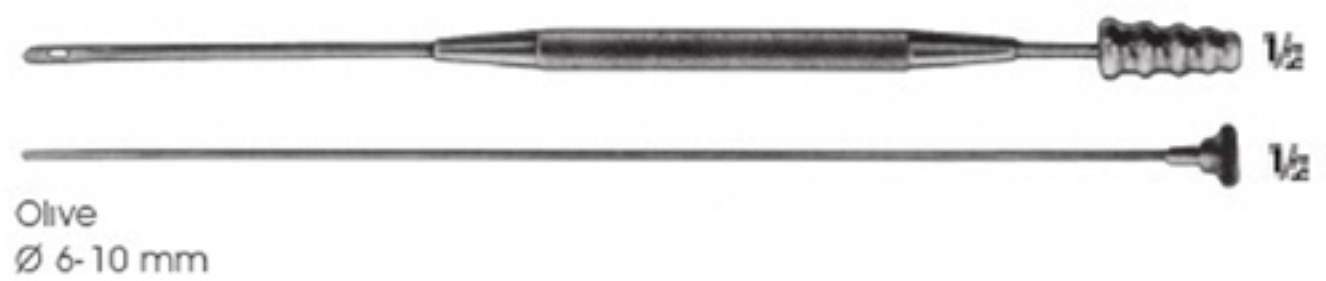

NEGUS  
EM-09-1420  
Suction dissector  
21 cm



LOPEZ-REINKE  
EM-09-1421  
Tonsil dissector with suction  
device  
23.5 cm



YASARGIL  
EM-09-1422  
Cannulae  
LUER-LOC cone  
20 cm





YASARGIL  
Suction tubes

EM-09-1423-01 Ø 1.5 mm	EM-09-1423-02 Ø 1.5 mm	EM-09-1423-03 Ø 1.5 mm	EM-09-1423-04 Ø 1.5 mm
EM-09-1423-05 Ø 2.0 mm	EM-09-1423-06 Ø 2.0 mm	EM-09-1423-07 Ø 2.0 mm	EM-09-1423-08 Ø 2.0 mm
EM-09-1423-09 Ø 2.5 mm	EM-09-1423-10 Ø 2.5 mm	EM-09-1423-11 Ø 2.5 mm	EM-09-1423-12 Ø 2.5 mm
EM-09-1423-13 Ø 3.5 mm	EM-09-1423-14 Ø 3.5 mm	EM-09-1423-15 Ø 3.5 mm	EM-09-1423-16 Ø 3.5 mm
13 cm	15 cm	18 cm	22 cm

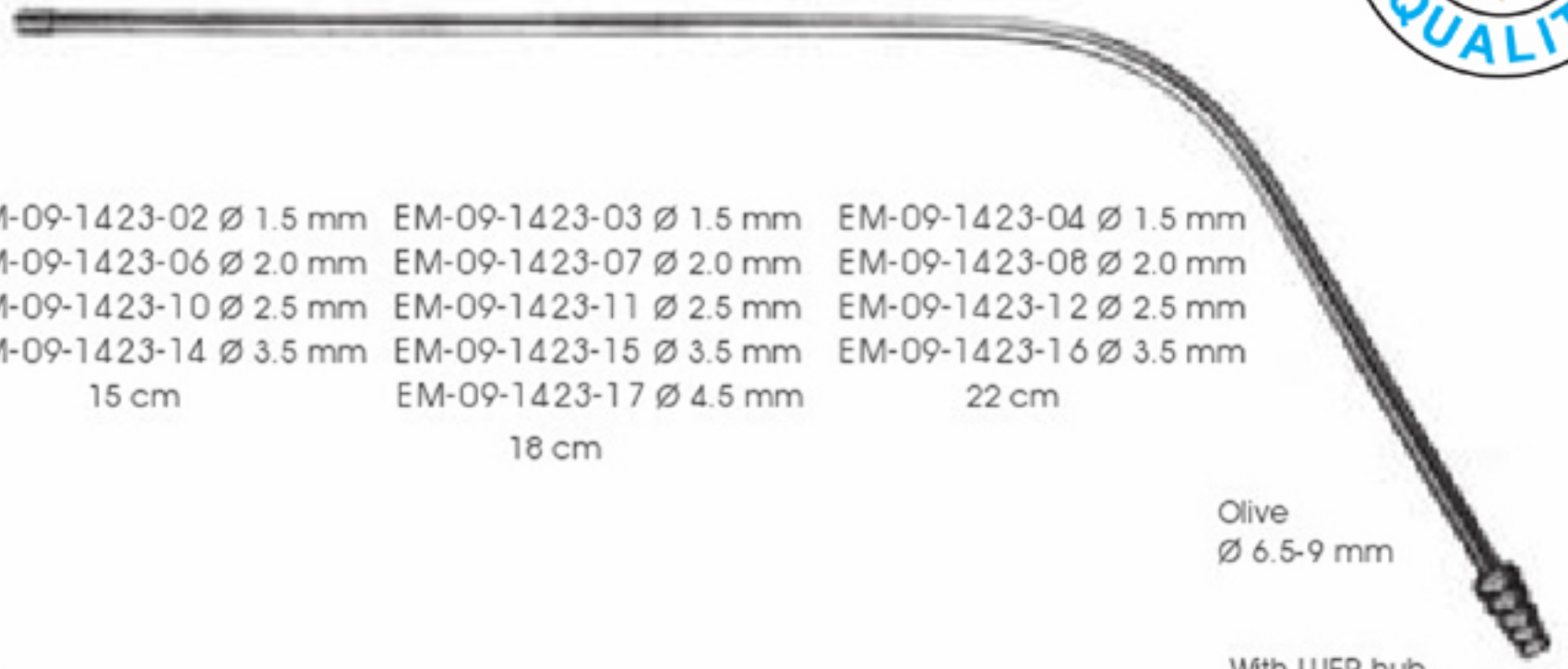

Olive  
Ø 6.5-9 mm

With LUER hub



EM-09-1424-01 50 cm  
EM-09-1424-02 35 cm  
Suction tubes  
With rubber tip

Olive  
Ø 6- 9 mm

With LUER hub



ROWBOTHAM  
EM-09-1425  
Cannulae  
29.5 cm



MAGILL  
EM-09-1426-01 Ø 3.0 mm  
EM-09-1426-02 Ø 3.5 mm  
EM-09-1426-03 Ø 4.0 mm  
Stylet for magill suction tubes  
24.5 cm

EM-09-1427  
For clearing large quantities of fluid  
19 cm

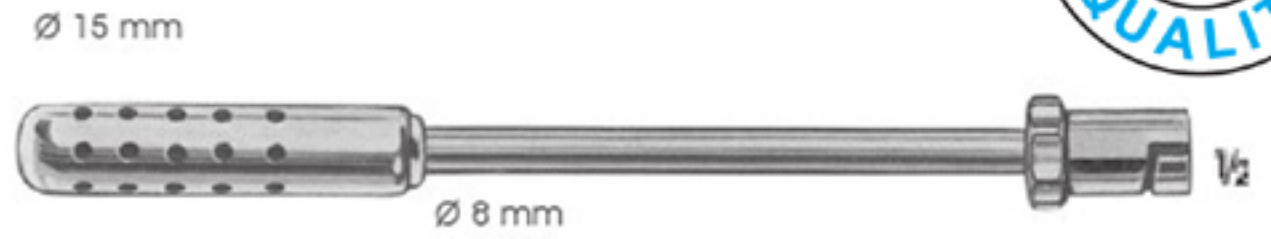

EM-09-1428  
Trocar, for puncturing  
17 cm



EM-09-1429  
Suction handle, with vacuum regulator  
and finger cut-off, brass, mirror-finish  
chromium-plated  
15 cm

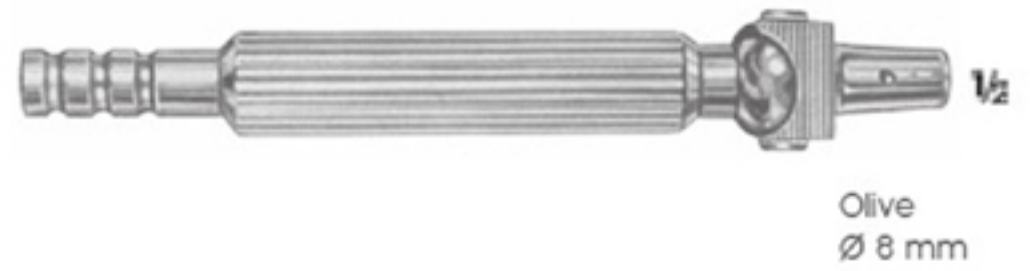

EM-09-1430  
Double curved, for general surgery  
23 cm



EM-09-1431 Ø 9 mm  
Universal cannula, double curved  
23 cm



POOL  
EM-09-1432  
Suction cannula, with outer tube to be  
screwed off  
22.5 cm



POOL  
EM-09-1433  
Suction cannula, with outer tube to be  
screwed off  
22.5 cm

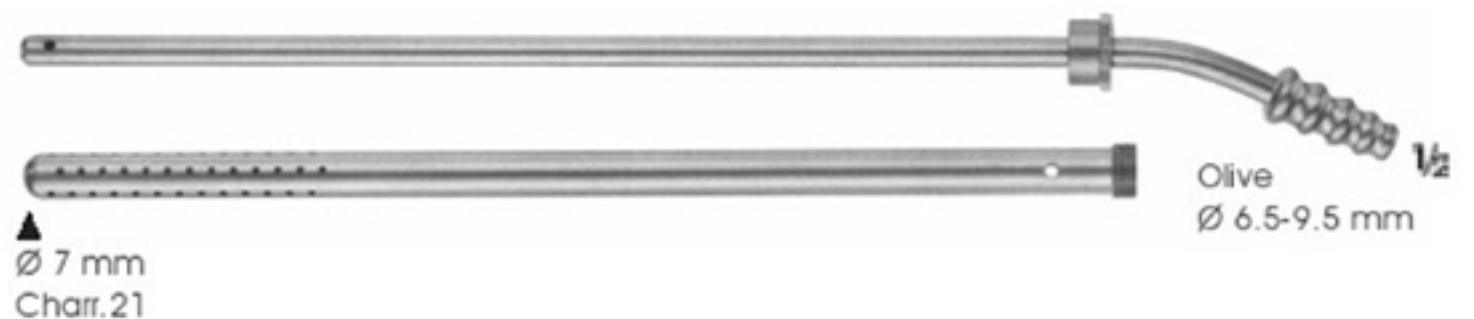



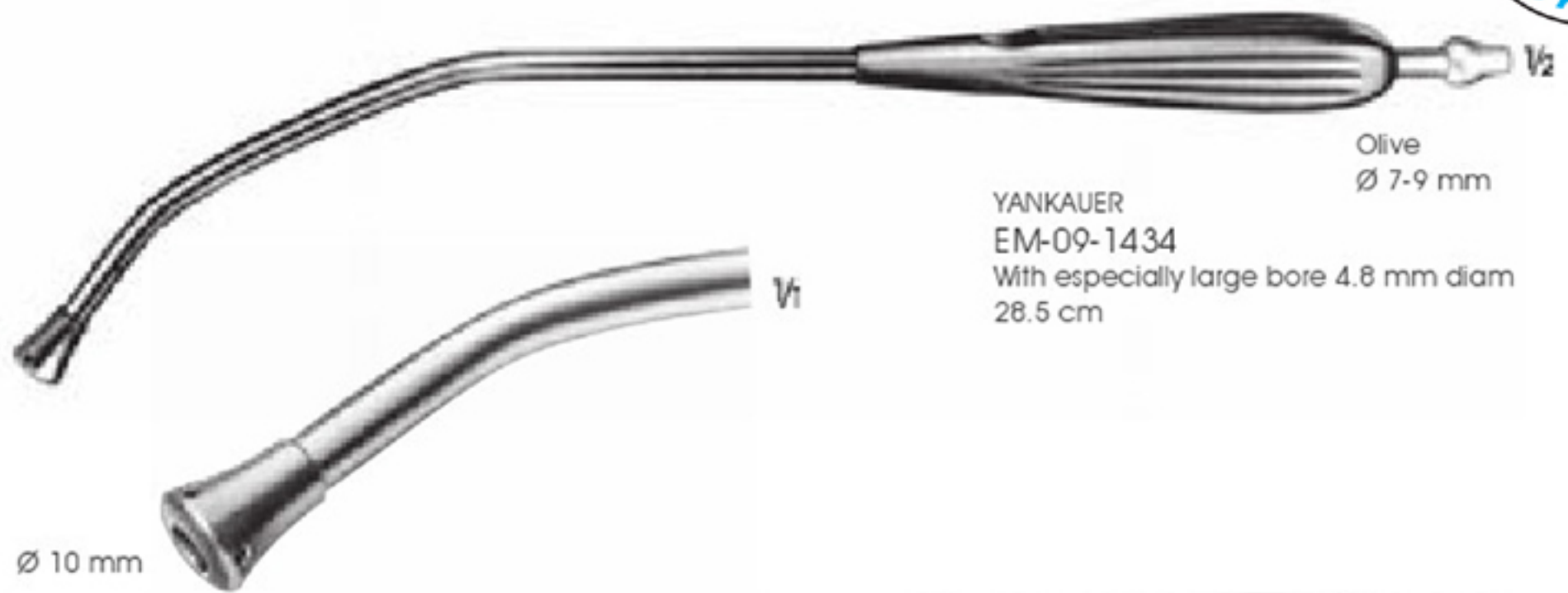

YANKAUER  
EM-09-1434  
With especially large bore 4.8 mm diam  
28.5 cm

Olive  
Ø 7-9 mm



YANKAUER  
EM-09-1435  
With central bore, 2.0 mm diam  
28.5 cm

Olive  
Ø 7-9 mm



DE BAKEY  
EM-09-1436  
With central bore, 3.0 mm  
diam  
27.5 cm

Olive  
Ø 6-10 mm



DE BAKEY  
EM-09-1437  
With finger cut-off and stylet  
27 cm

Olive  
Ø 9 mm



DE BAKEY  
EM-09-1438  
With finger cut-off and stylet  
16 cm

Olive  
Ø 9 mm





Ø 15 mm

FINSTERER  
EM-09-1439  
Irrigation cannula  
32 cm

Olive  
Ø 9-13 mm 1/2

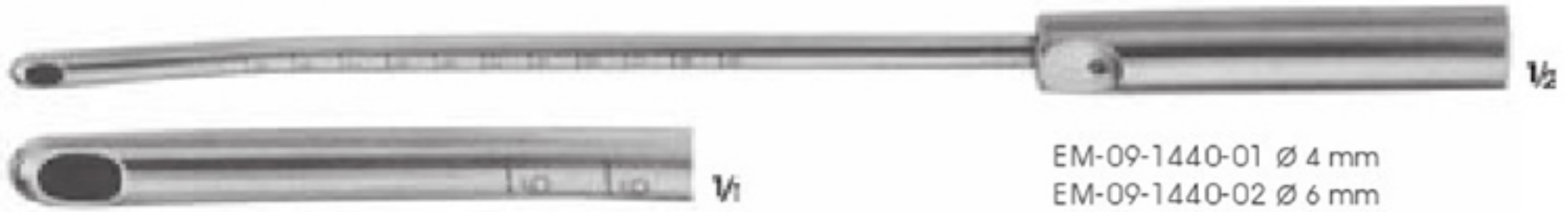

EM-09-1440-01 Ø 4 mm  
EM-09-1440-02 Ø 6 mm  
EM-09-1440-03 Ø 8 mm  
EM-09-1440-04 Ø 10 mm  
EM-09-1440-05 Ø 12 mm  
EM-09-1440-06 Ø 14 mm  
Curettes with graduation and suction interrupter, for vacuum curettage

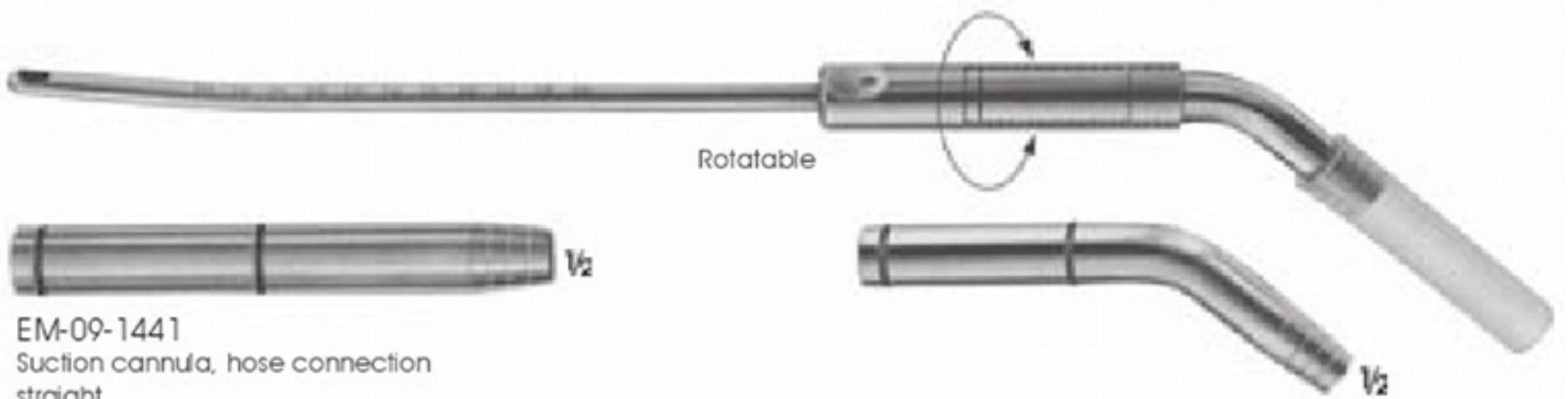

Rotatable

EM-09-1441  
Suction cannula, hose connection  
straight  
Ø 11 mm

EM-09-1442  
Suction cannula, hose connection,  
curved  
Ø 11 mm



15 cm

Vakum hortumu için bağlantı  
Connection for suction hose

LANDOLT  
EM-09-1443 Insulated  
Coagulation suction cannula  
with interruptor and mandrel Ø 5 mm  
Can be sterilized in a steam sterilizer up to 143



Çap/Olive  
Ø 7.5-12 mm

HF-Elektrot kolu Ø 4 mm  
Untarnished contact to be  
touched by HF-electrodes Ø 4 mm



EM-09-1444  
4 ucu ile birlikte  
sökülebilir trokar  
Trocar with interchangeable  
tips (4 pcs.)



PIERCE  
EM-09-1445 Ø 4.0 mm  
Antrum trokar  
Antrum trocar



KRAUSE  
EM-09-1446 Ø 4.0 mm  
Antrum trokar  
Antrum trocar



	Inside	Outside
EM-09-1447-01	Ø 2.2 mm	Ø 3.3 mm
EM-09-1447-02	Ø 3.0 mm	Ø 4.0 mm
EM-09-1447-03	Ø 4.0 mm	Ø 5.0 mm
EM-09-1447-04	Ø 5.0 mm	Ø 6.0 mm

For abdominal puncture, with  
stop-cock and lateral drain.



BUELAU  
EM-09-1448-01  
EM-09-1448-02  
Empyema trokar

	Inside	Outside
EM-09-1448-01	Ø 6.5 mm	Ø 8.0 mm
EM-09-1448-02	Ø 9.0 mm	Ø 10.0 mm

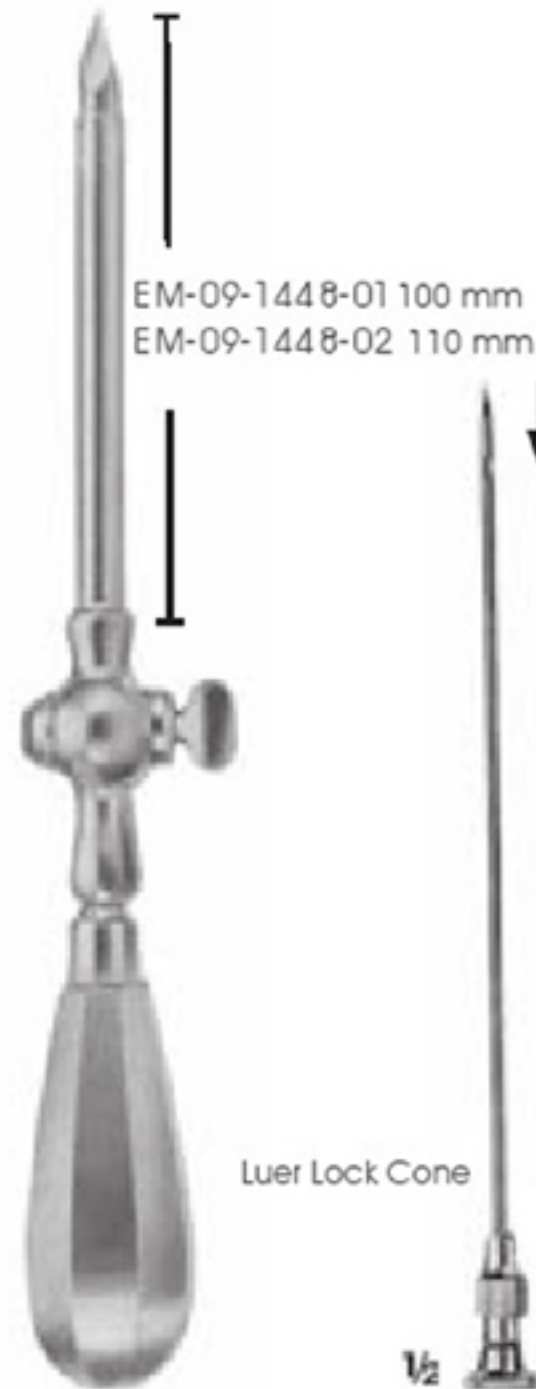

LANDAU  
EM-09-1449  
Ø 2 mm  
Pelvic abscess trokar



KLIMA-ROSEGGER  
EM-09-1450 35 x 1.8 mm  
Sternal puncture needle



	Charr.
EM-09-1451-01	8
EM-09-1451-02	10
EM-09-1451-03	12
EM-09-1451-04	14
EM-09-1451-05	16
EM-09-1451-06	18

With thread, knife tip, slightly curved  
19 cm



	Charr.
EM-09-1451-07	8
EM-09-1451-08	10
EM-09-1451-09	12
EM-09-1451-10	14
EM-09-1451-11	16
EM-09-1451-12	18

With thread knife tip, strongly curved  
19 cm



	Charr.
EM-09-1451-13	8
EM-09-1451-14	10
EM-09-1451-15	12
EM-09-1451-16	14
EM-09-1451-17	16
EM-09-1451-18	18

With thread, lancet tip, slightly curved  
19 cm



	Charr.
EM-09-1451-19	8
EM-09-1451-20	10
EM-09-1451-21	12
EM-09-1451-22	14
EM-09-1451-23	16
EM-09-1451-24	18

With thread, trocar tip, slightly curved  
19 cm