



General Surgery

Generelle Operation



ALLEN
EM-12-1854
15.5 cm



BAINBRIDGE
EM-12-1855 - 1856
15.5 cm



DOYEN
EM-12-1857 - 1858
Elastic
16.5 cm

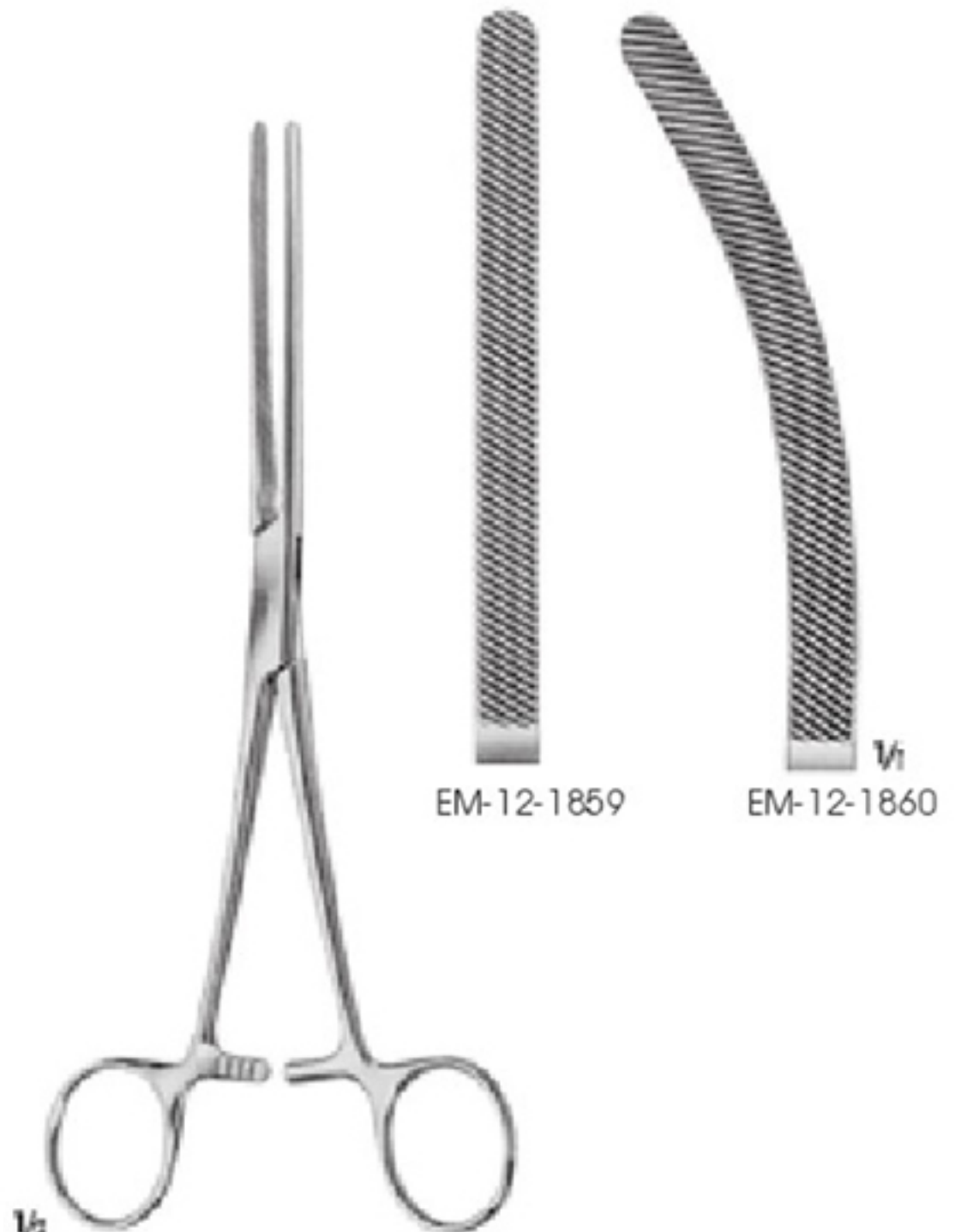

HARTMANN
EM-12-1859 - 1860
Soft and elastic
20 cm

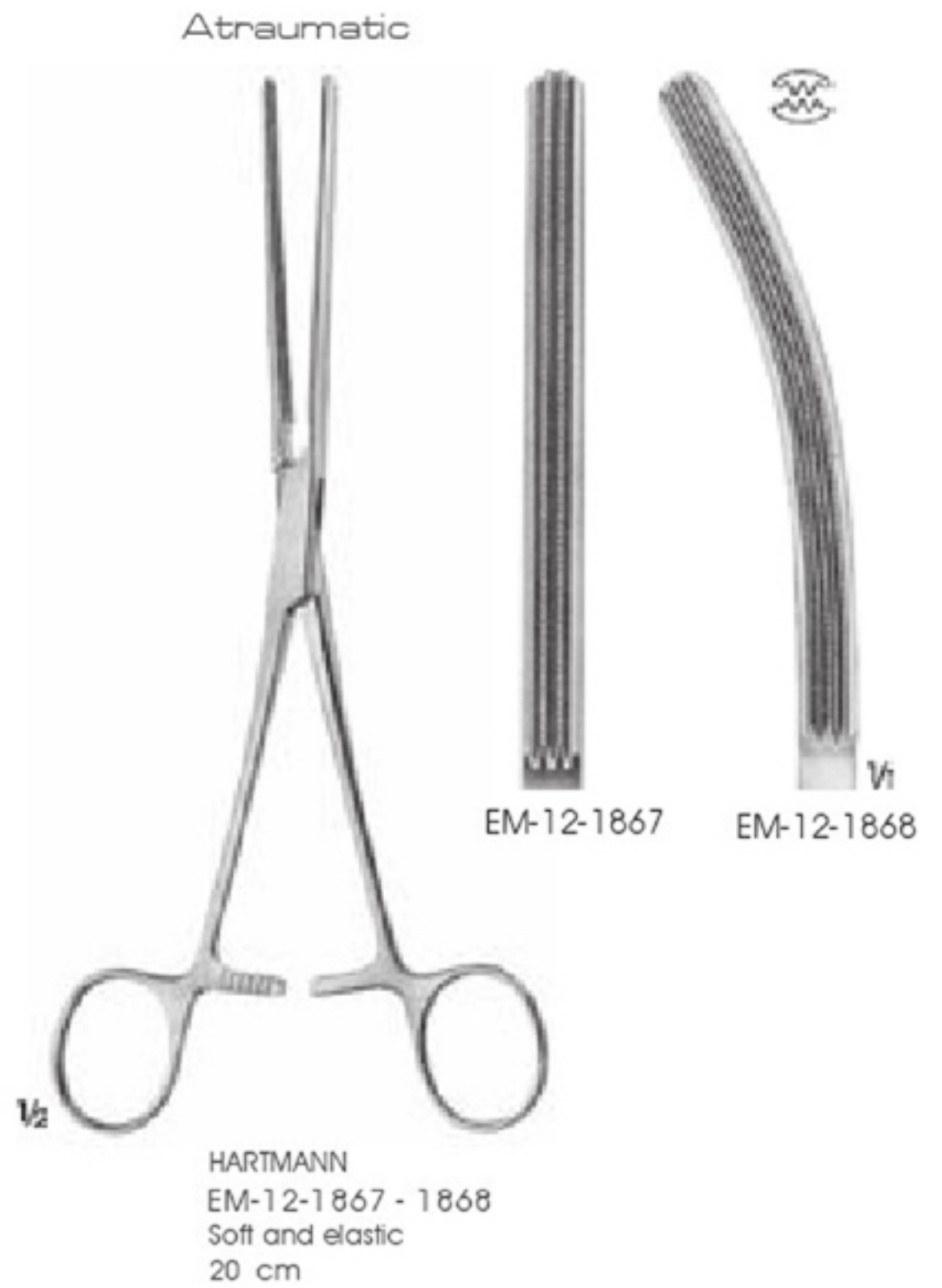
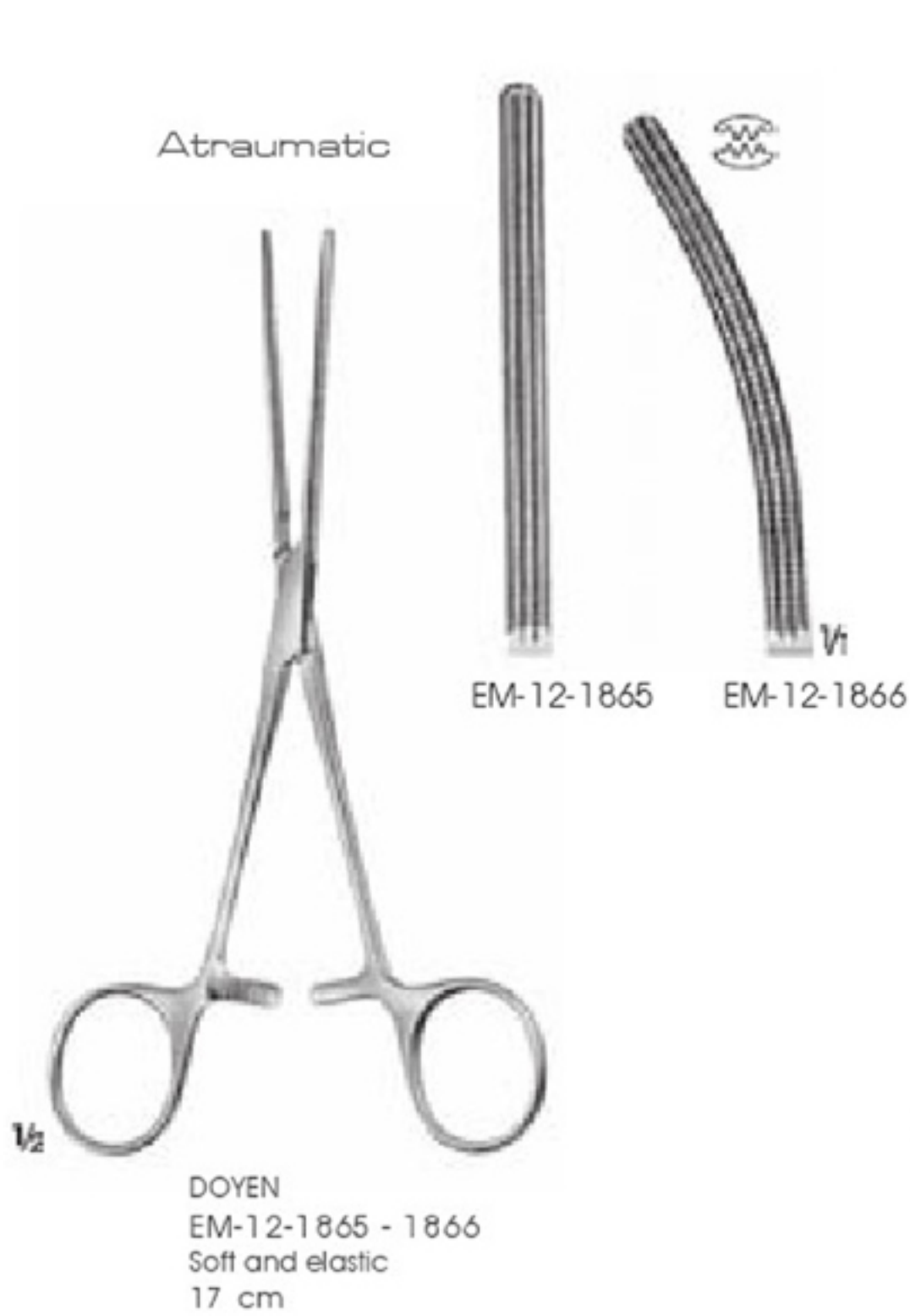
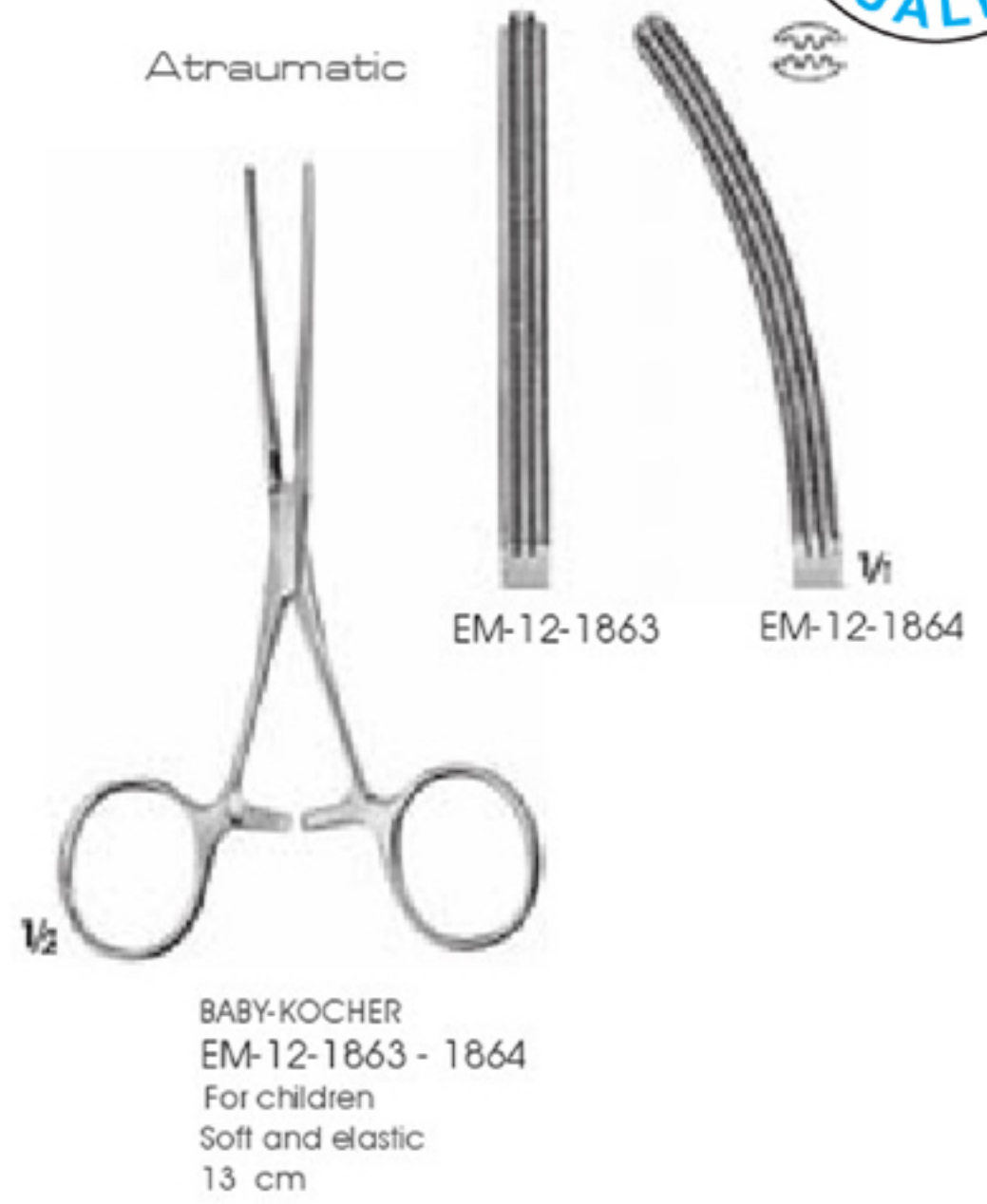

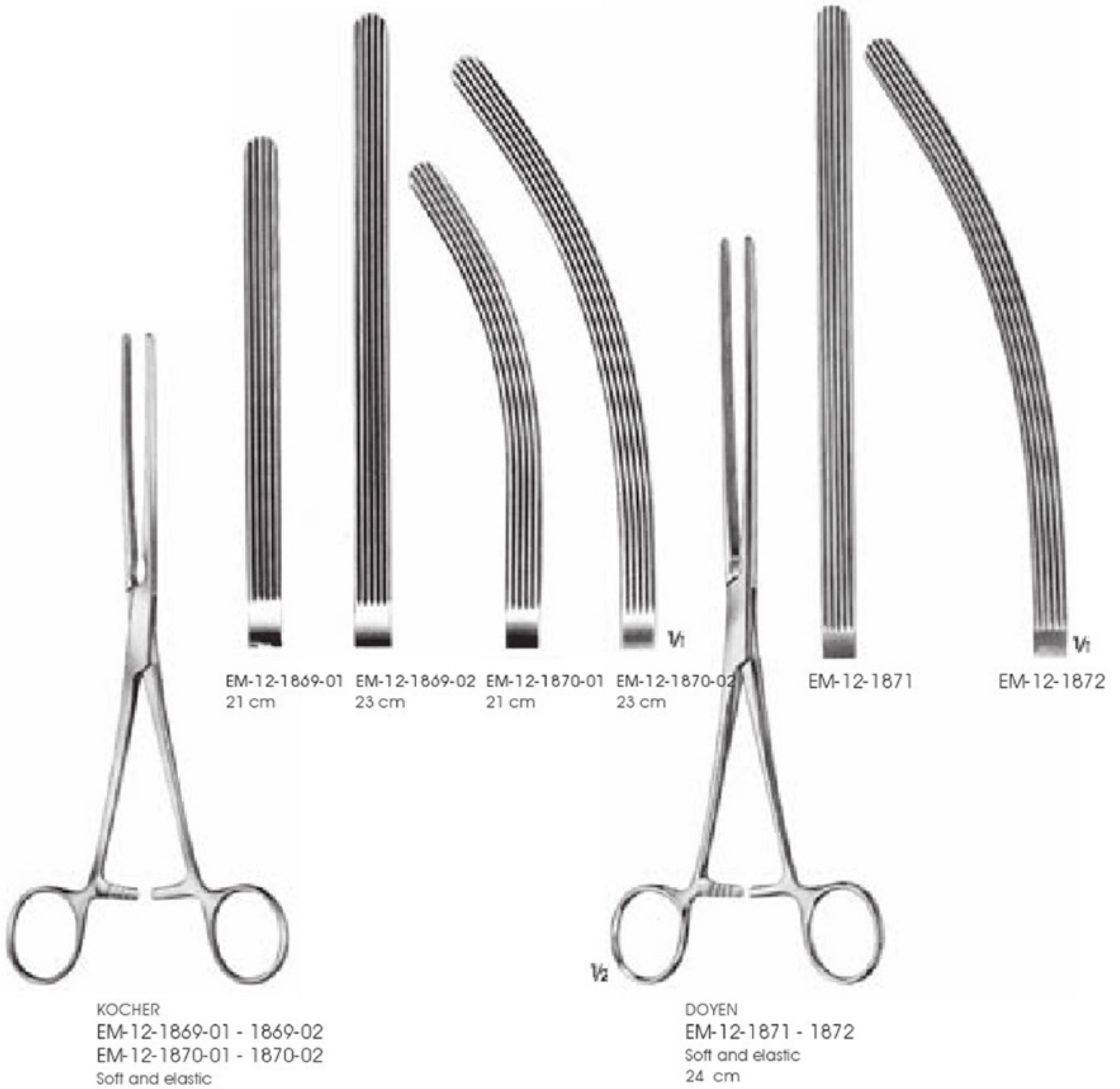

Atraumatic



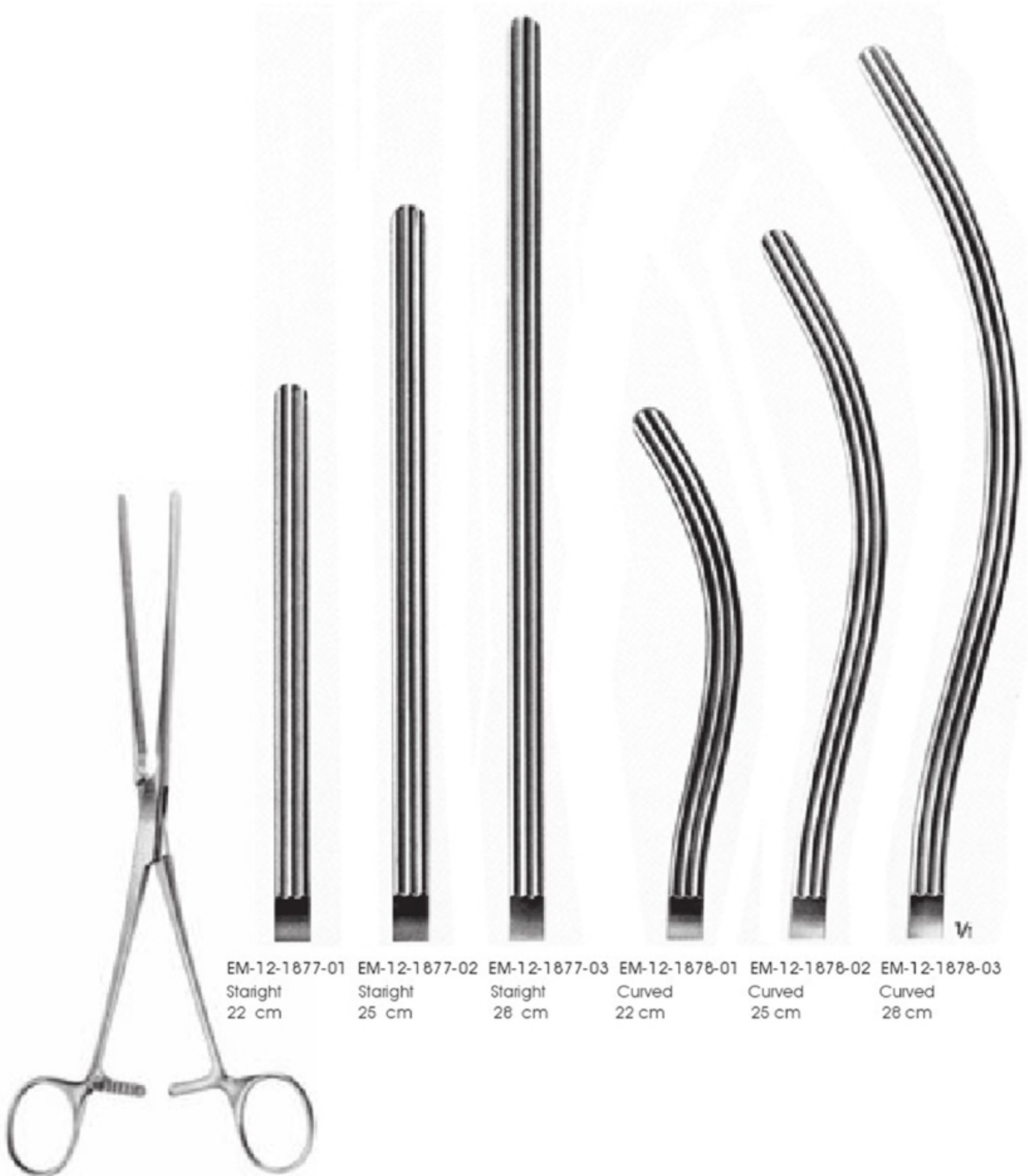

EM-12-1877-01	EM-12-1877-02	EM-12-1877-03	EM-12-1878-01	EM-12-1878-02	EM-12-1878-03
Straight	Straight	Straight	Curved	Curved	Curved
22 cm	25 cm	28 cm	22 cm	25 cm	28 cm

KOCHER
EM-12-1877-01 - 1877-03
EM-12-1878-01 - 1878-03
Soft and elastic

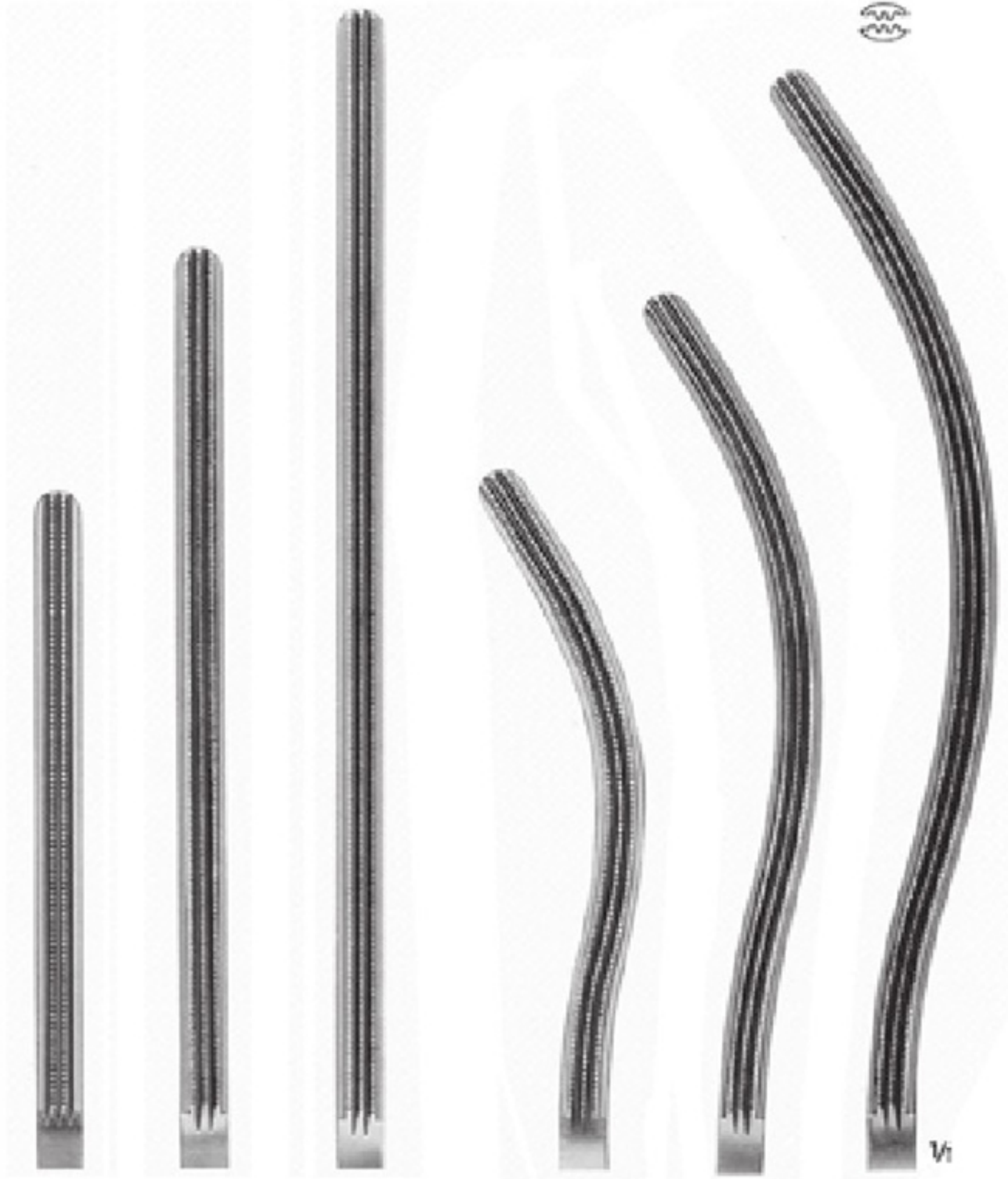

EM-12-1879-01
Straight
22 cm

EM-12-1879-02
Straight
25 cm

EM-12-1879-03
Straight
28 cm

EM-12-1890-01
Curved
22 cm

EM-12-1890-02
Curved
25 cm

EM-12-1890-03
Curved
28 cm

KOCHER
EM-12-1879-01 - 1879-03
EM-12-1890-01 - 1890-03
Soft and elastic

Atraumatic

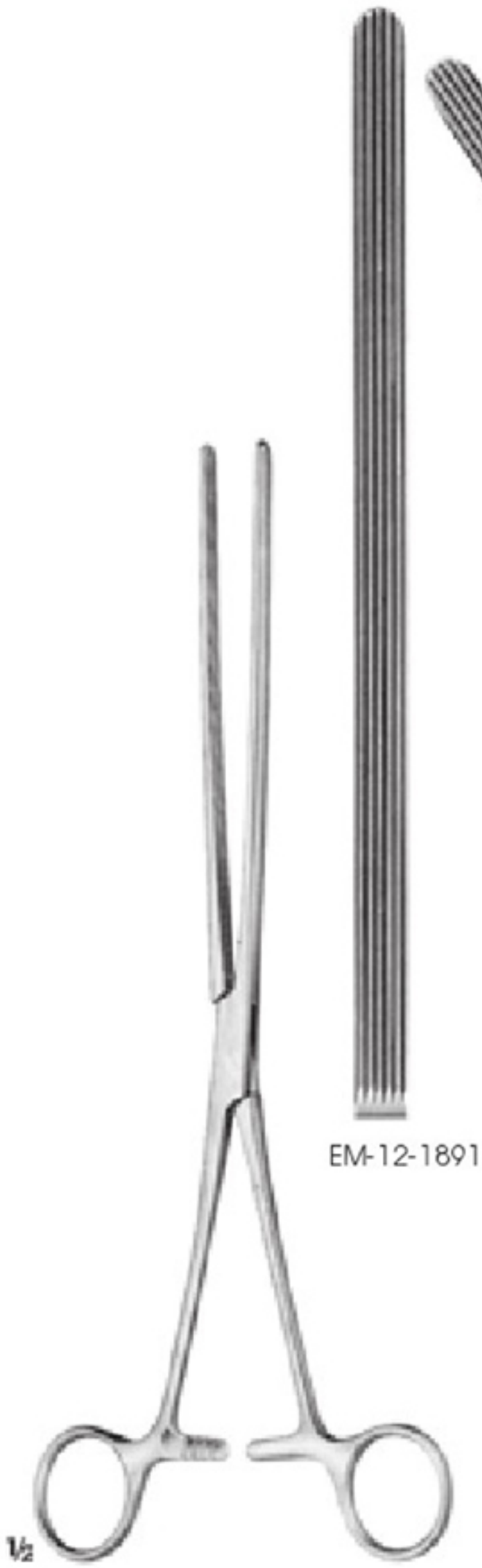

EM-12-1891

MAYO-ROBSON
EM-12-1891 - 1892
Hard and elastic
25 cm



EM-12-1892

1/2

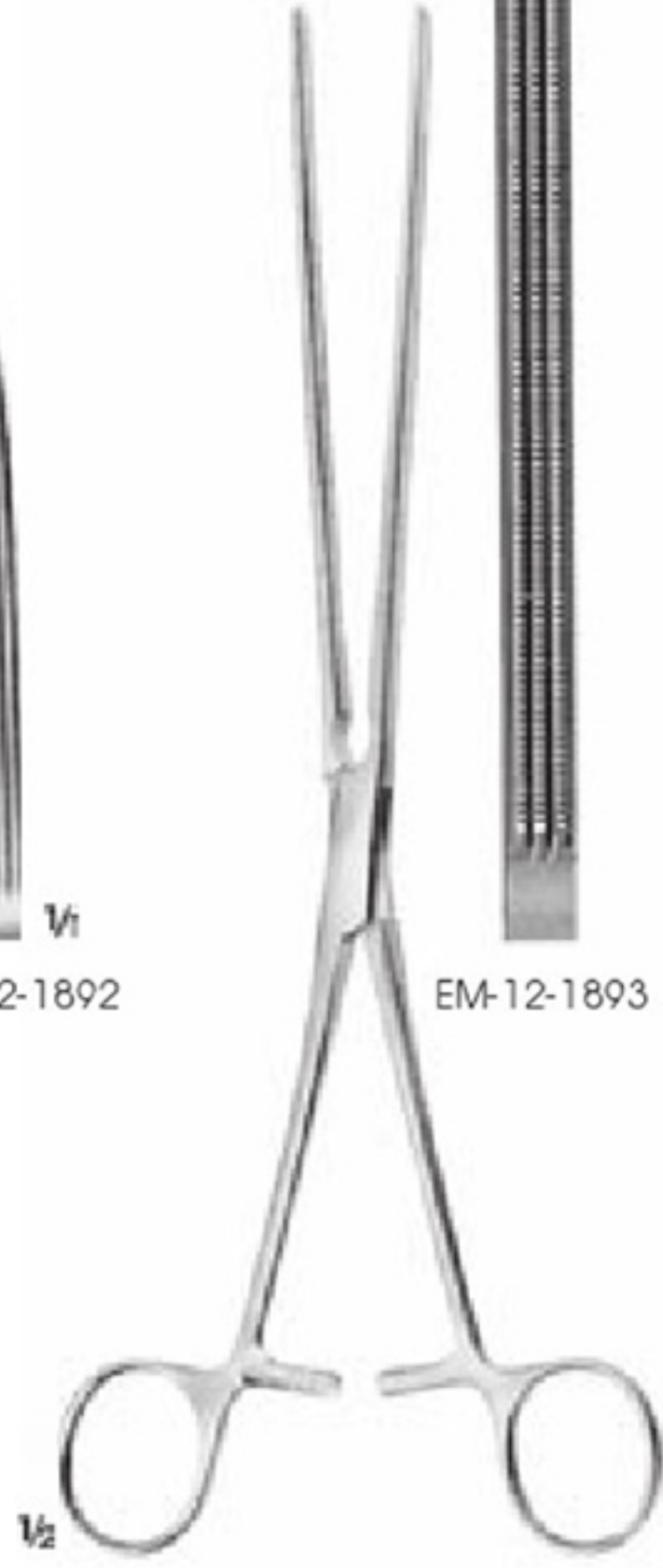

EM-12-1893

MAYO-ROBSON
EM-12-1893 - 1894
25 cm

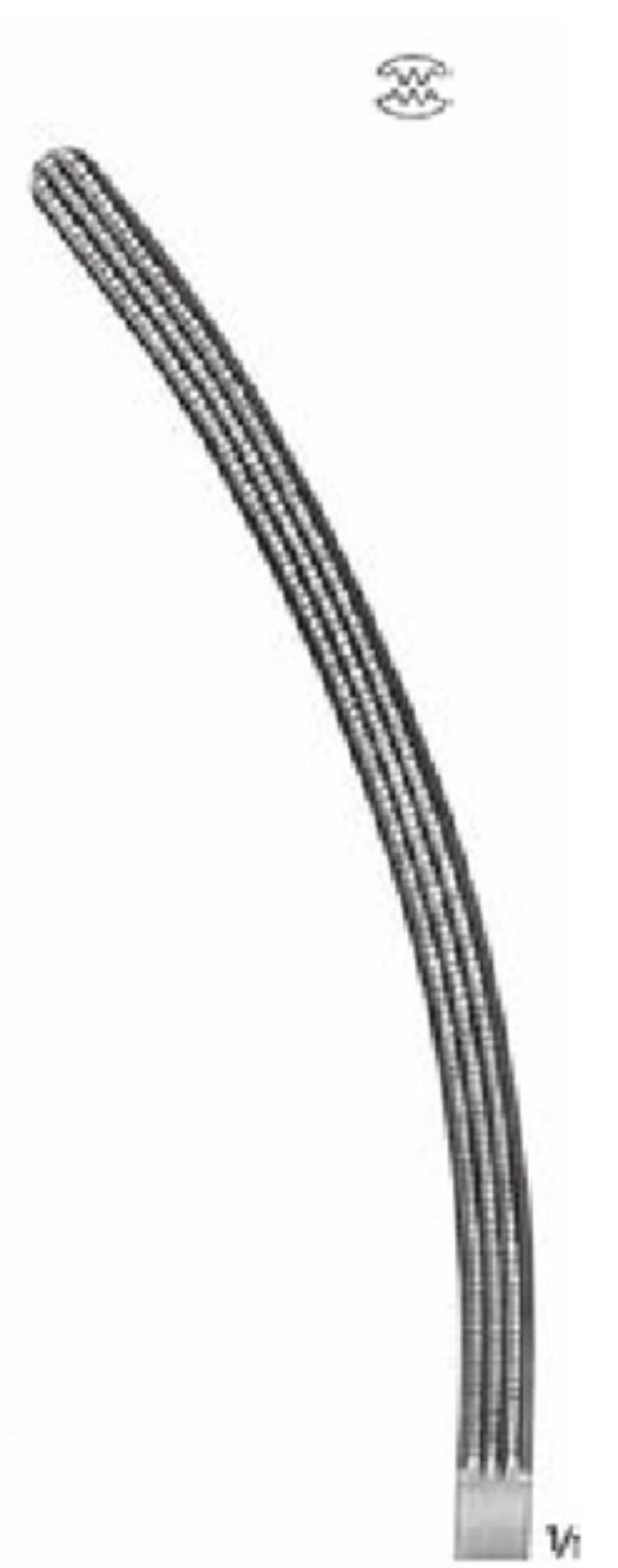

EM-12-1894



NUSSBAUM
EM-12-1895 - 1896
Soft and elastic
25 cm

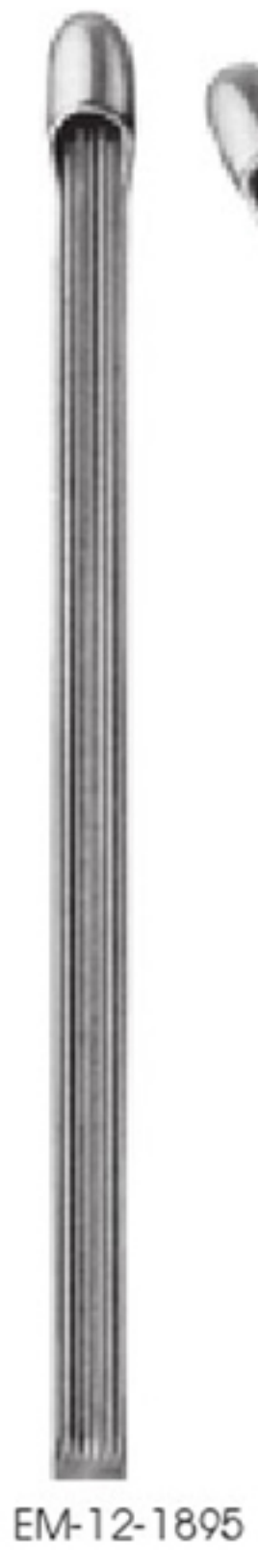

EM-12-1895



EM-12-1896

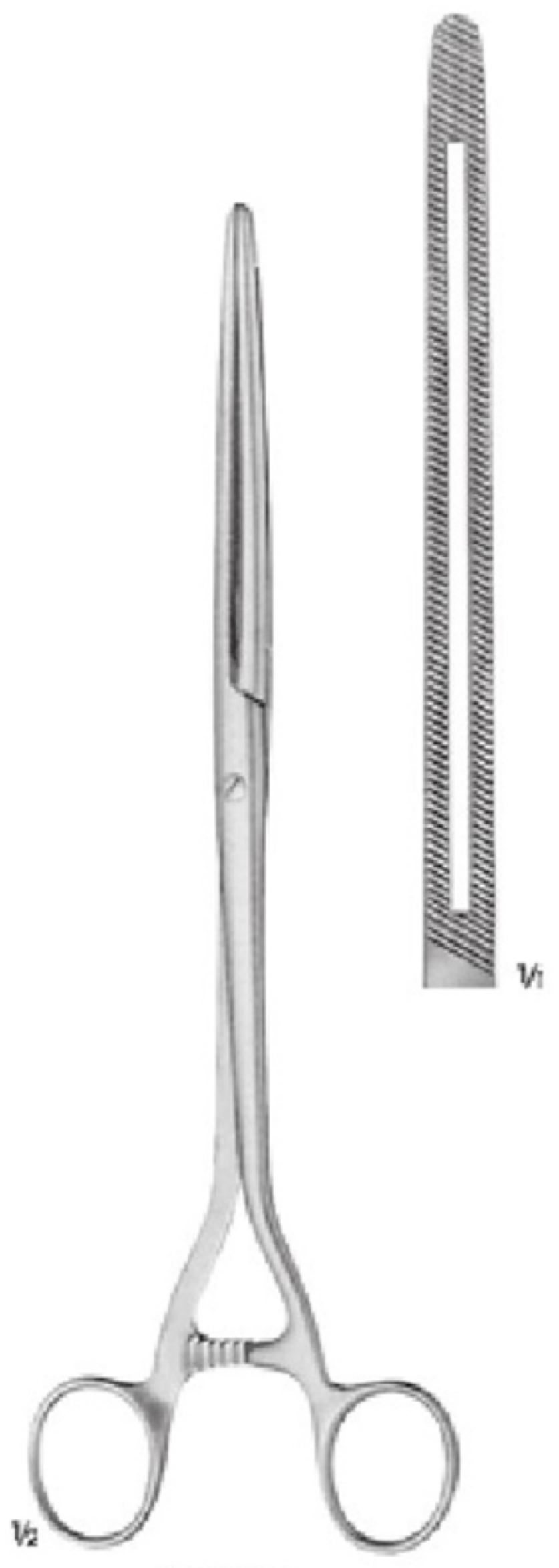

MAYNIHAN
EM-12-1897
28 cm



EM-12-1897

Atraumatic



$\frac{1}{2}$ $\frac{1}{1}$
SCHOEMAKER
EM-12-1898
Colectomy clamp
20 cm

$\frac{1}{2}$ $\frac{1}{1}$
LANG-STEVENSON
EM-12-1899
Intestinal clamp
20 cm

$\frac{1}{2}$ $\frac{1}{1}$
SCUDDER
EM-12-1900
Stomach clamp
33 cm



$\frac{1}{2}$
 PAYR
 EM-12-1901
 Intestinal clamp light pattern,
 for children
 18 cm

$\frac{1}{2}$
 PAYR
 EM-12-1902
 20 cm

$\frac{1}{2}$
 PAYR
 EM-12-1903
 27.5 cm

$\frac{1}{2}$
 PAYR
 EM-12-1904
 Pylorus clamp
 31.5 cm



LANE
EM-12-1905
31 cm



LANE
EM-12-1906
31 cm



1/2

HABERER
EM-12-1907
36 cm



1/1



BENSON
 EM-12-1908
 Pylorus spreader
 15.5 cm



KLEINSCHMIDT
 EM-12-1909
 Appendectomy clamp
 13 cm



DE MARTEL-WOLFSON
 EM-12-1910-01 10 cm
 EM-12-1910-021 12 cm
 Anastomosis clamps,
 set of 3



EM-12-1911-01 22.5 cm
 Clamp holder
 (EM-12-1910-01 - 1910-02)



Sert Klemp tutucu
 Clamp holder with set of clamps

EM-12-1911-02 8 cm
 Clamp holder
 (EM-12-1910-01 - 1910-02)



DE MARTEL-WOLFSON
 EM-12-1912
 Closing forceps
 (EM-12-1910-01 - 1910-02)
 25 cm



Atraumatic



DICK
EM-12-1913-01 25.5 cm
EM-12-1913-02 26.5 cm
EM-12-1913-03 27.5 cm
Pressure clamps



EM-12-1913-01 78 mm
EM-12-1913-02 88 mm
EM-12-1913-03 98 mm

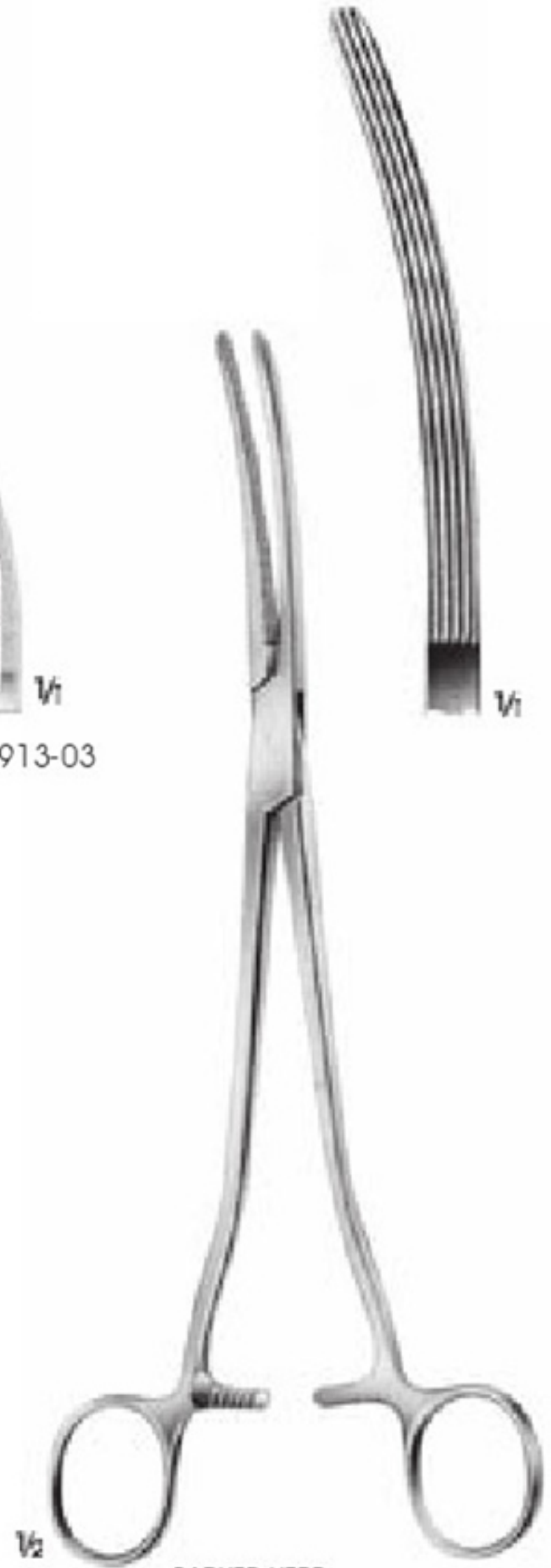

PARKER-KERR
EM-12-1914
Anastomosis forceps for
colon resection
25 cm

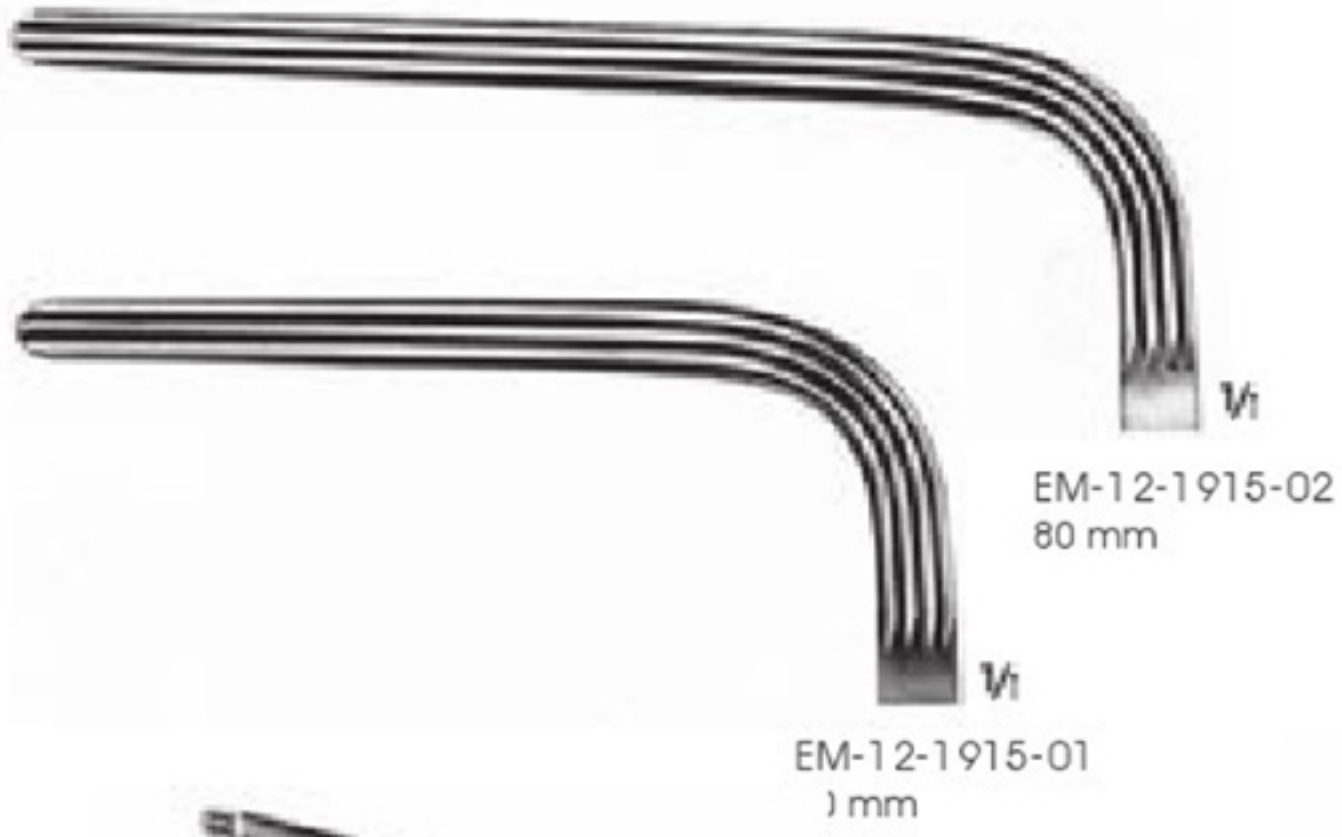

EM-12-1915-01 - 1915-02
23 cm



BRUNNER
EM-12-1916
24.5 cm



LLOYD-DAVIS
EM-12-1917
31.5 cm

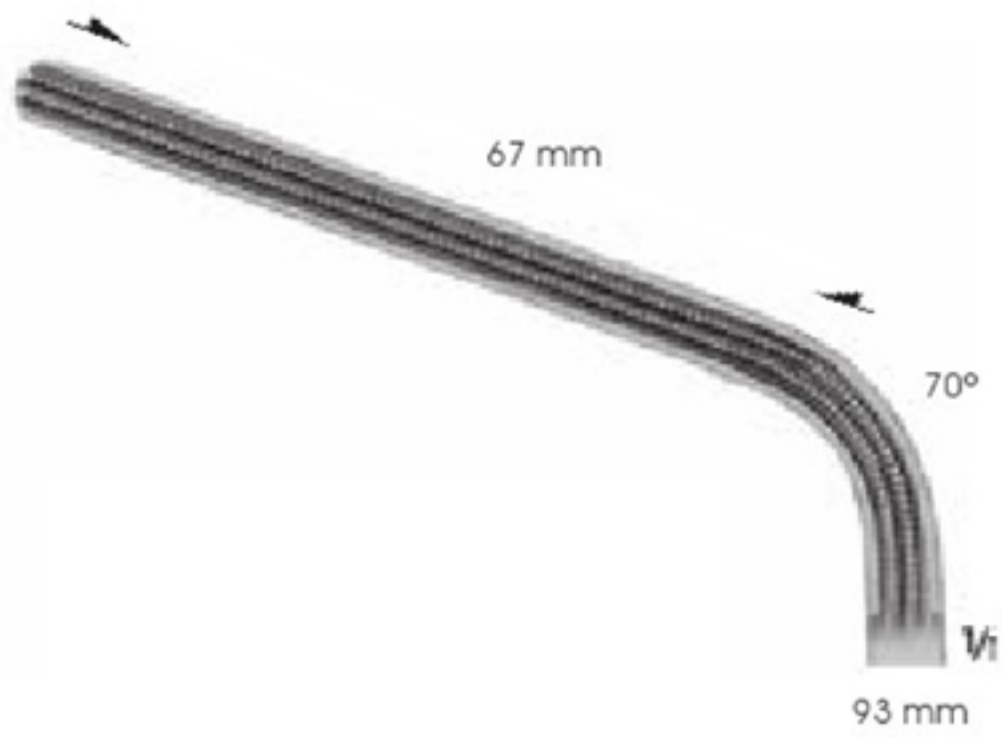

MORRIS
EM-12-1918
17.5 cm

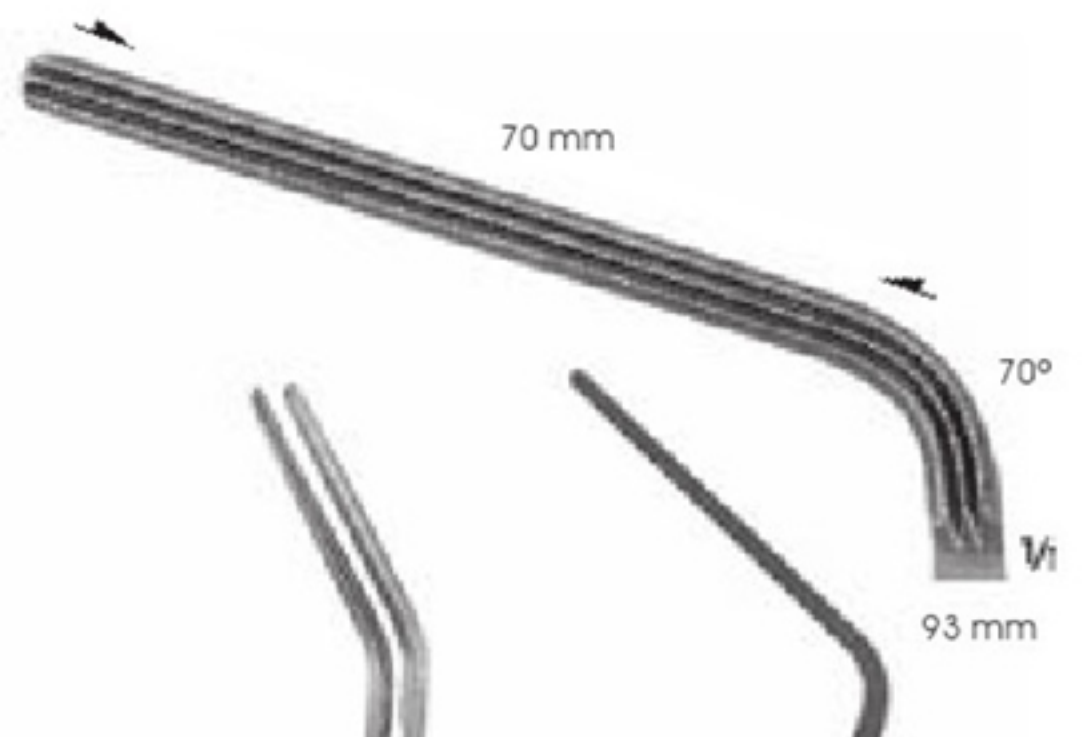

DE BAKEY (MORRIS)
EM-12-1919
24 cm



KERSTING
EM-12-1920
30 cm

RESONE
EM-12-1921
Elastic
26.5 cm

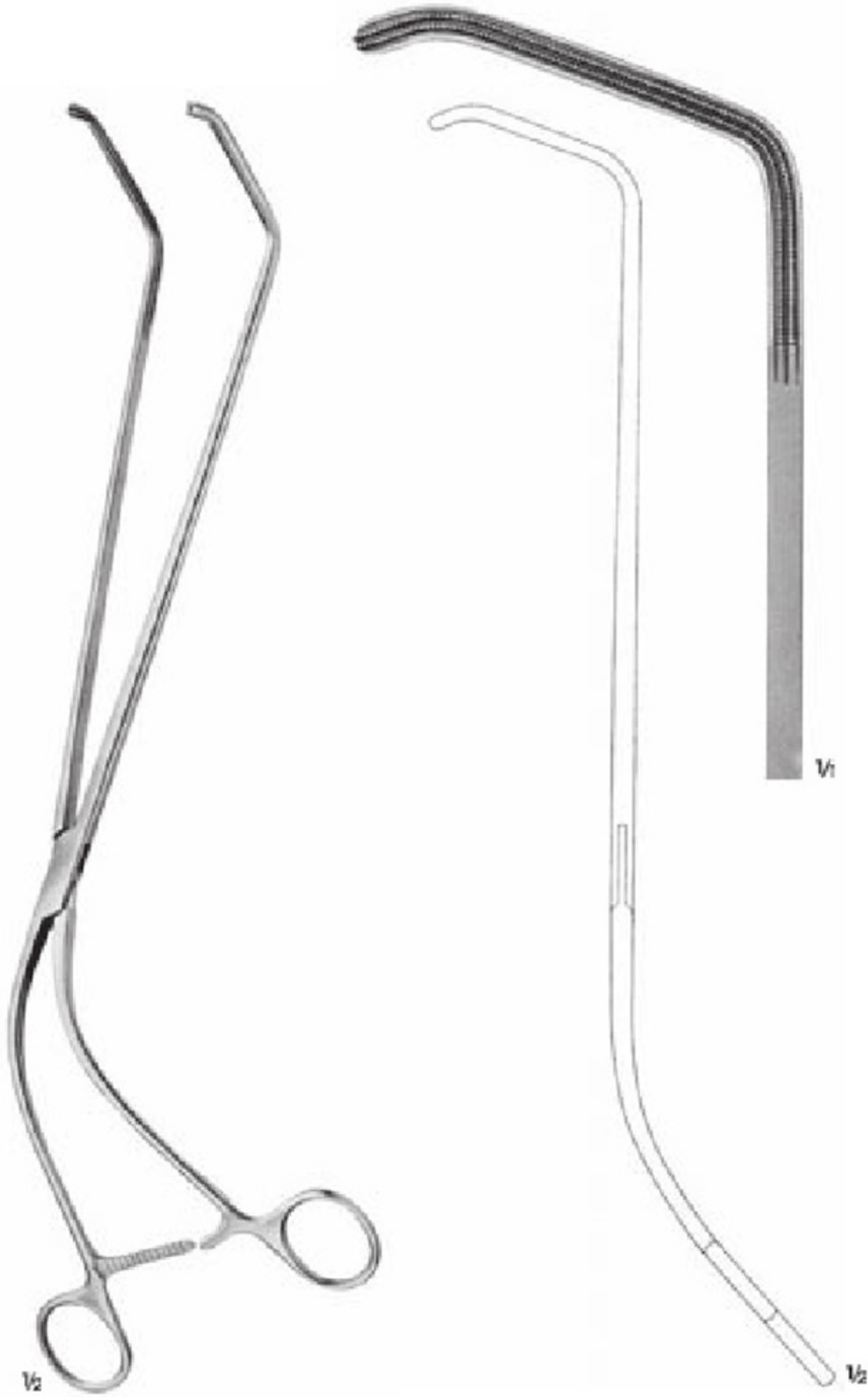

MULLER
EM-12-1922
Rectal anastomosis clamp
37.5 cm

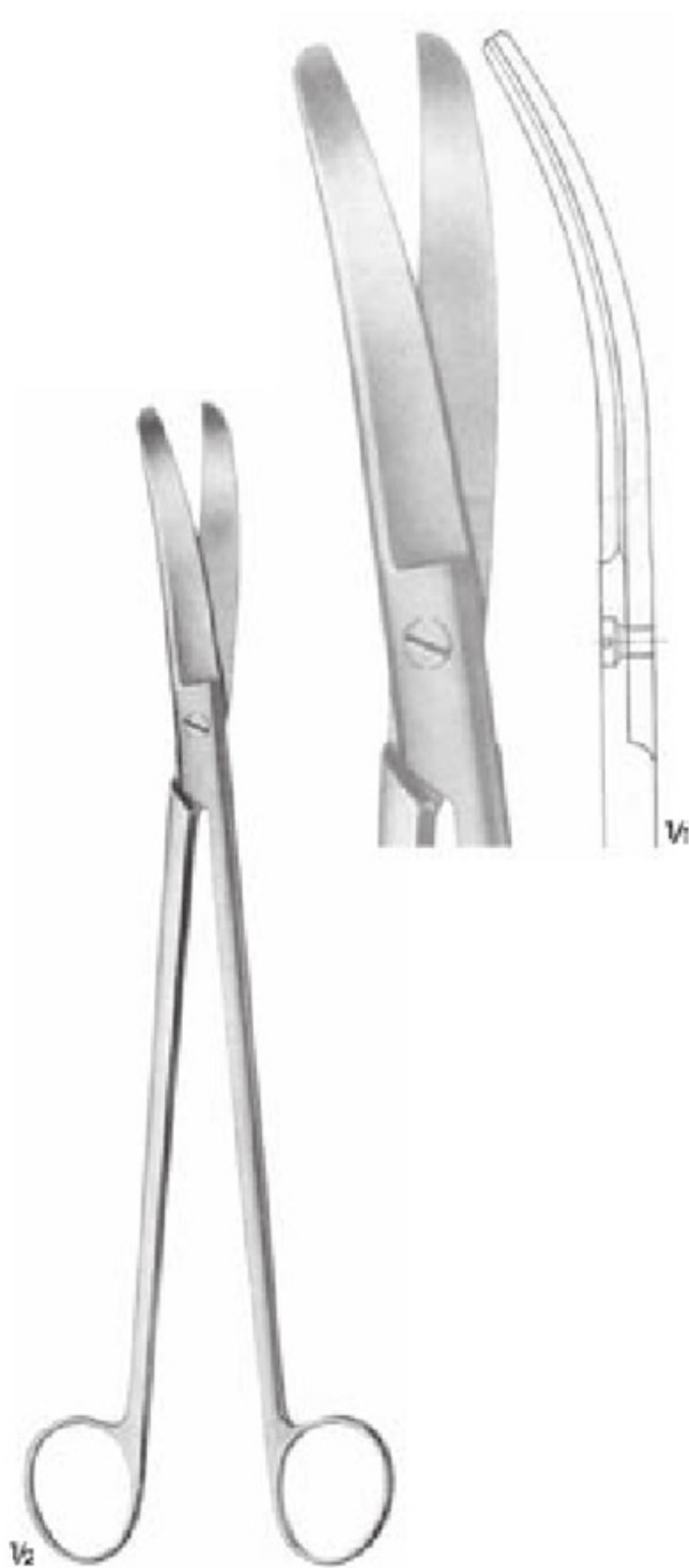

LLOYD-DAVIES (GOLIGHER'S)
EM-12-1923
27 cm

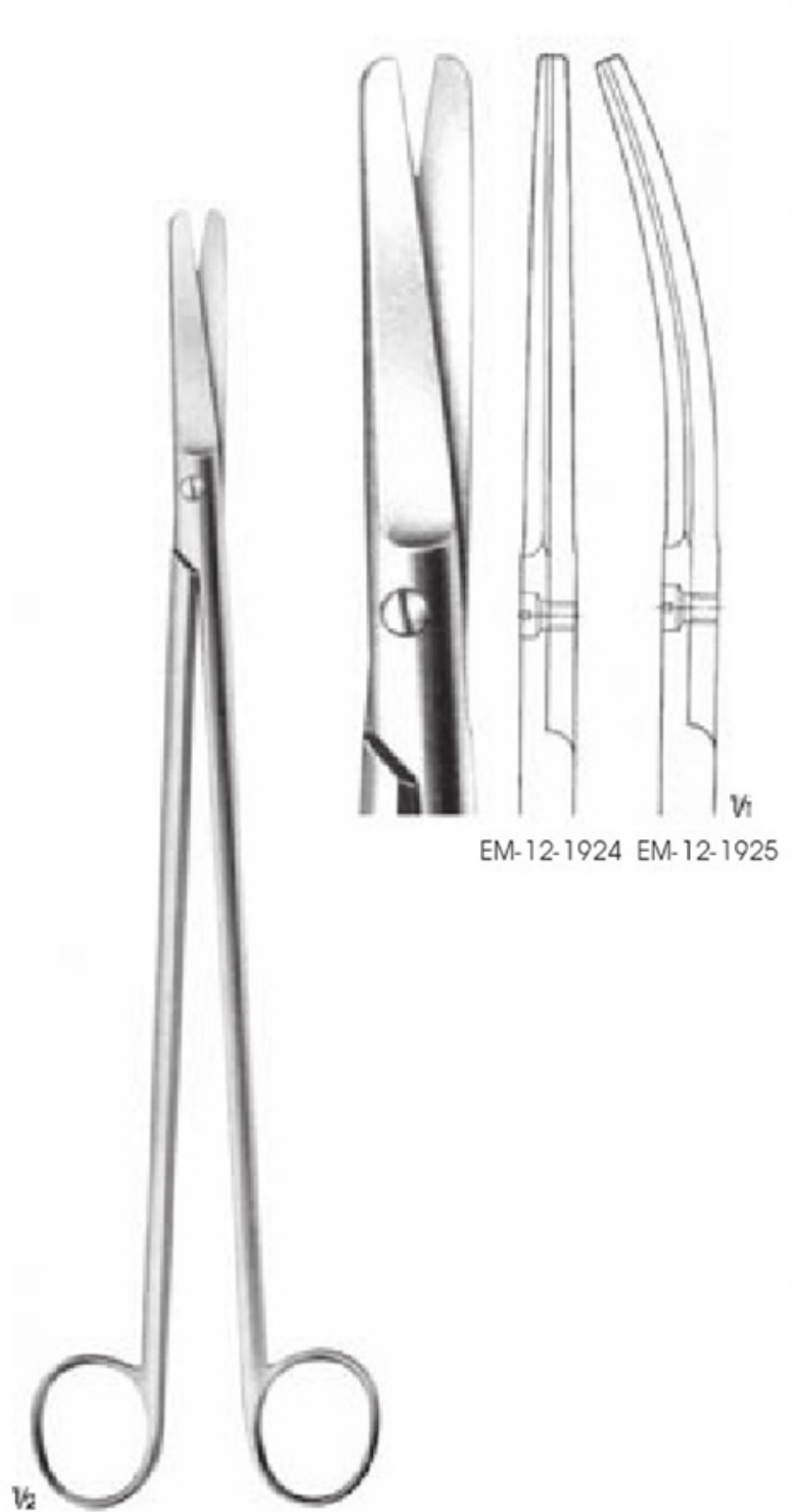

STELZNER
EM-12-1924 - 1925
31 cm

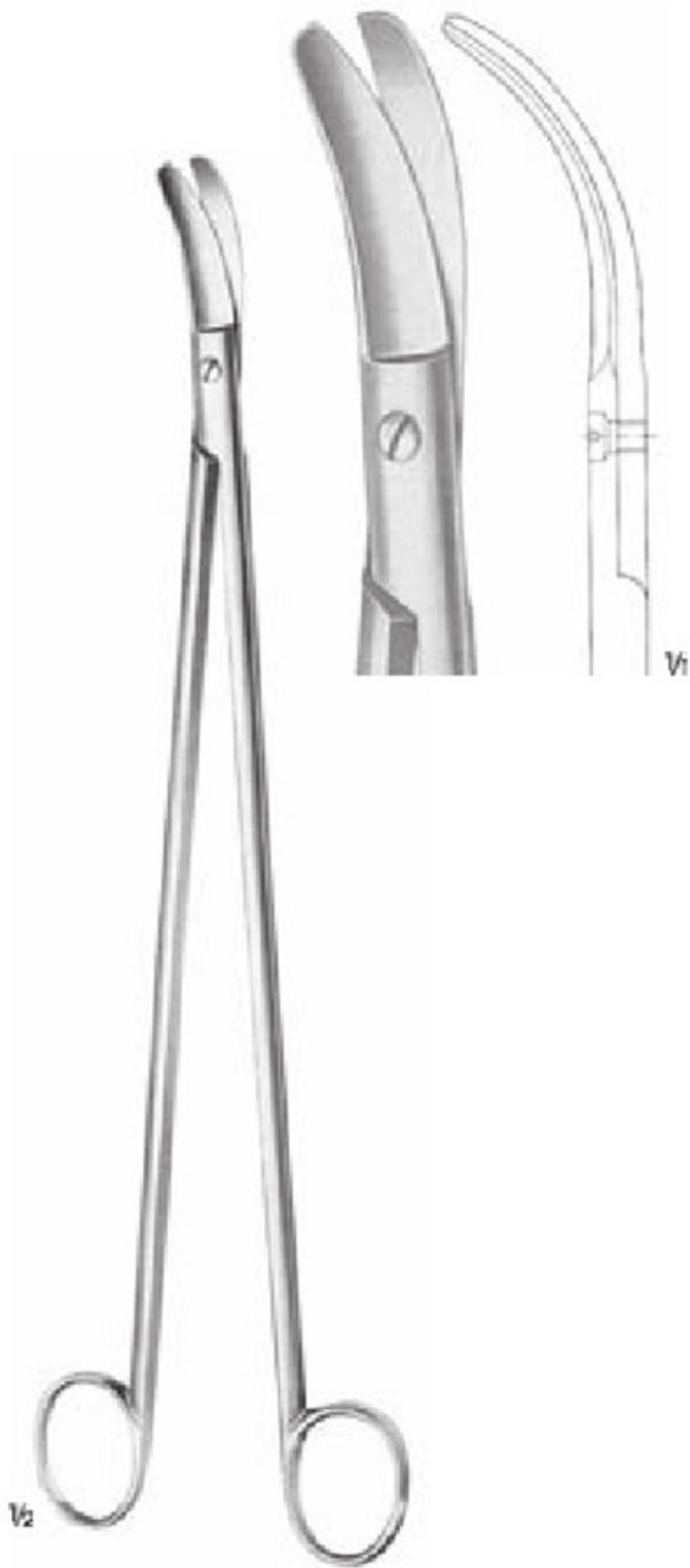

EM-12-1926
Rectal scissors
32.5 cm

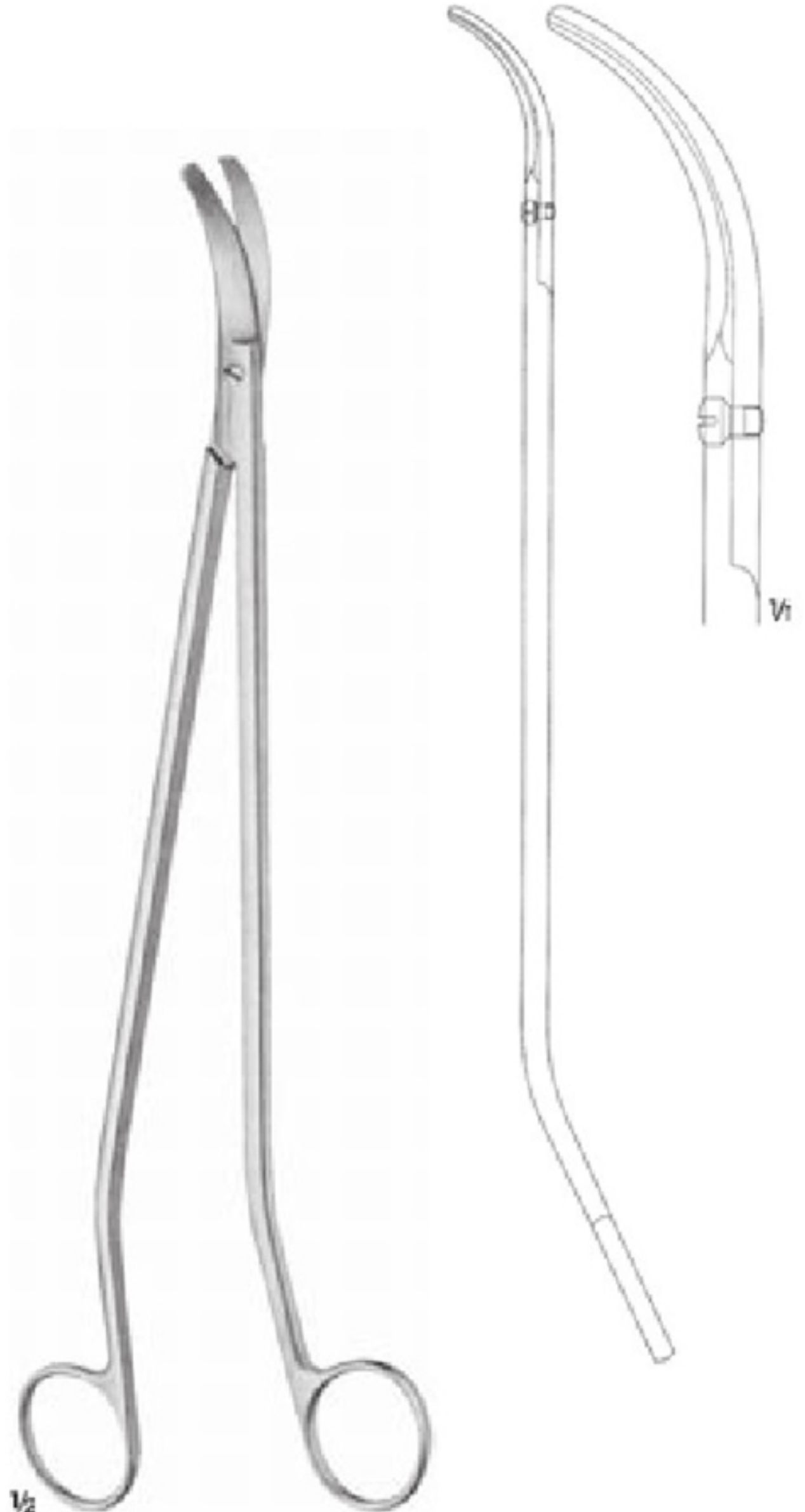

MÜLLER
EM-12-1927
Rectum scissors s-shaped
32.5 cm

HARDTIPS



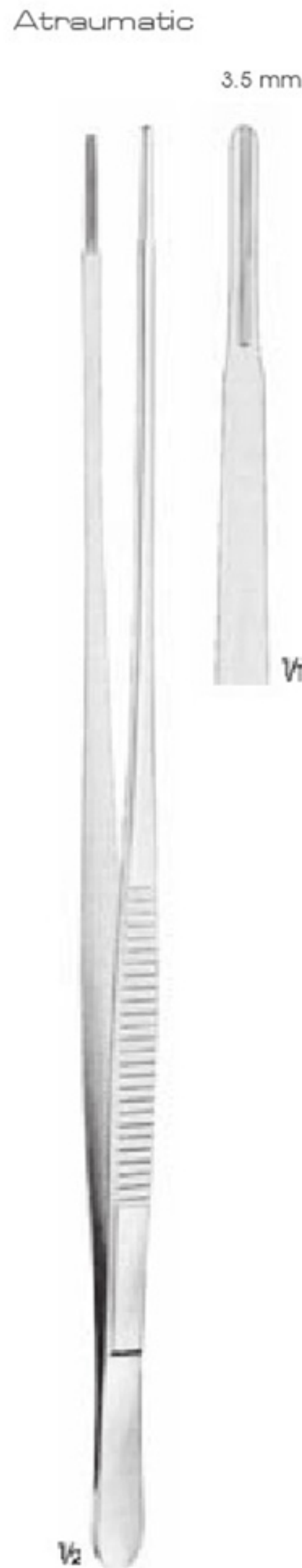

ALLIS
EM-12-1928
Grasping forceps
29.5 cm



DE BAKHEY
EM-12-1929
35 cm

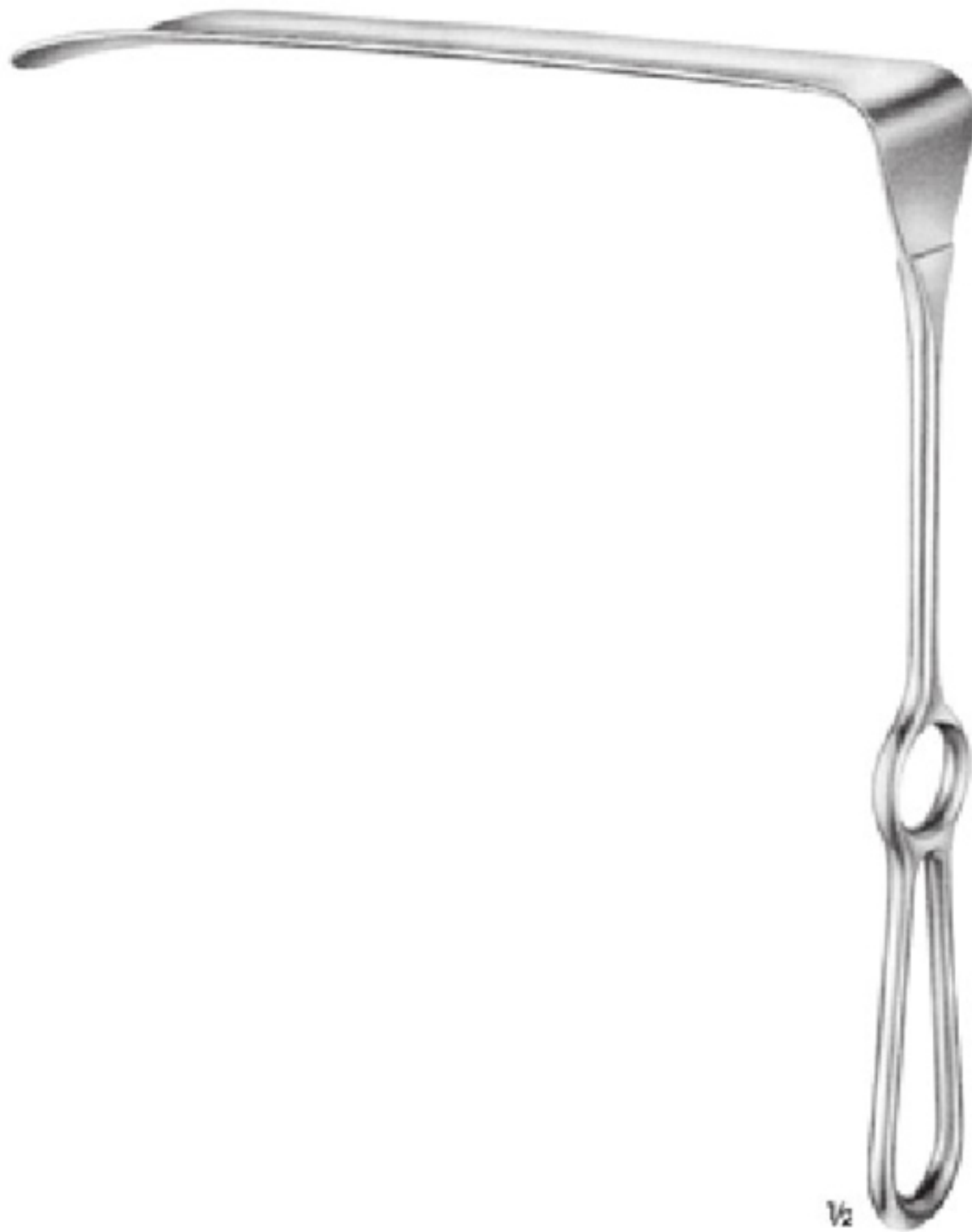
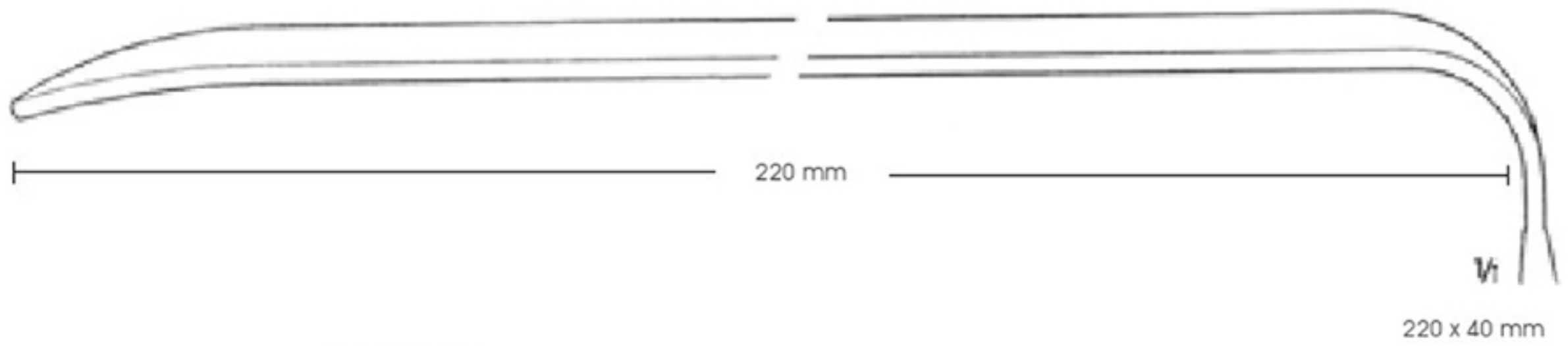

MÜLLER
EM-12-1930
Needle holder
36 cm



1/2

HÖSEL
EM-12-1931
Retractor
25 cm

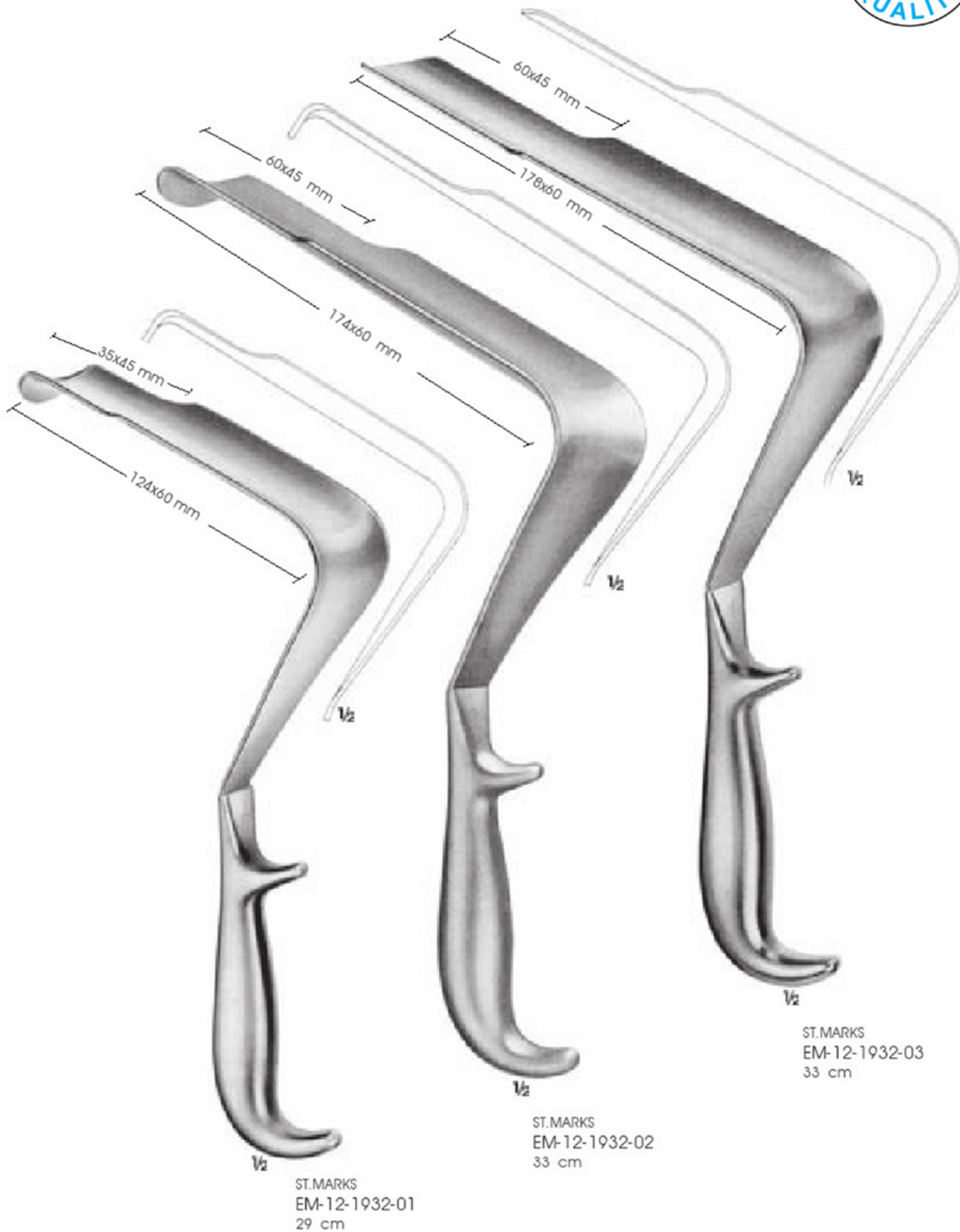



CZERNY
EM-12-1933
22.5 cm

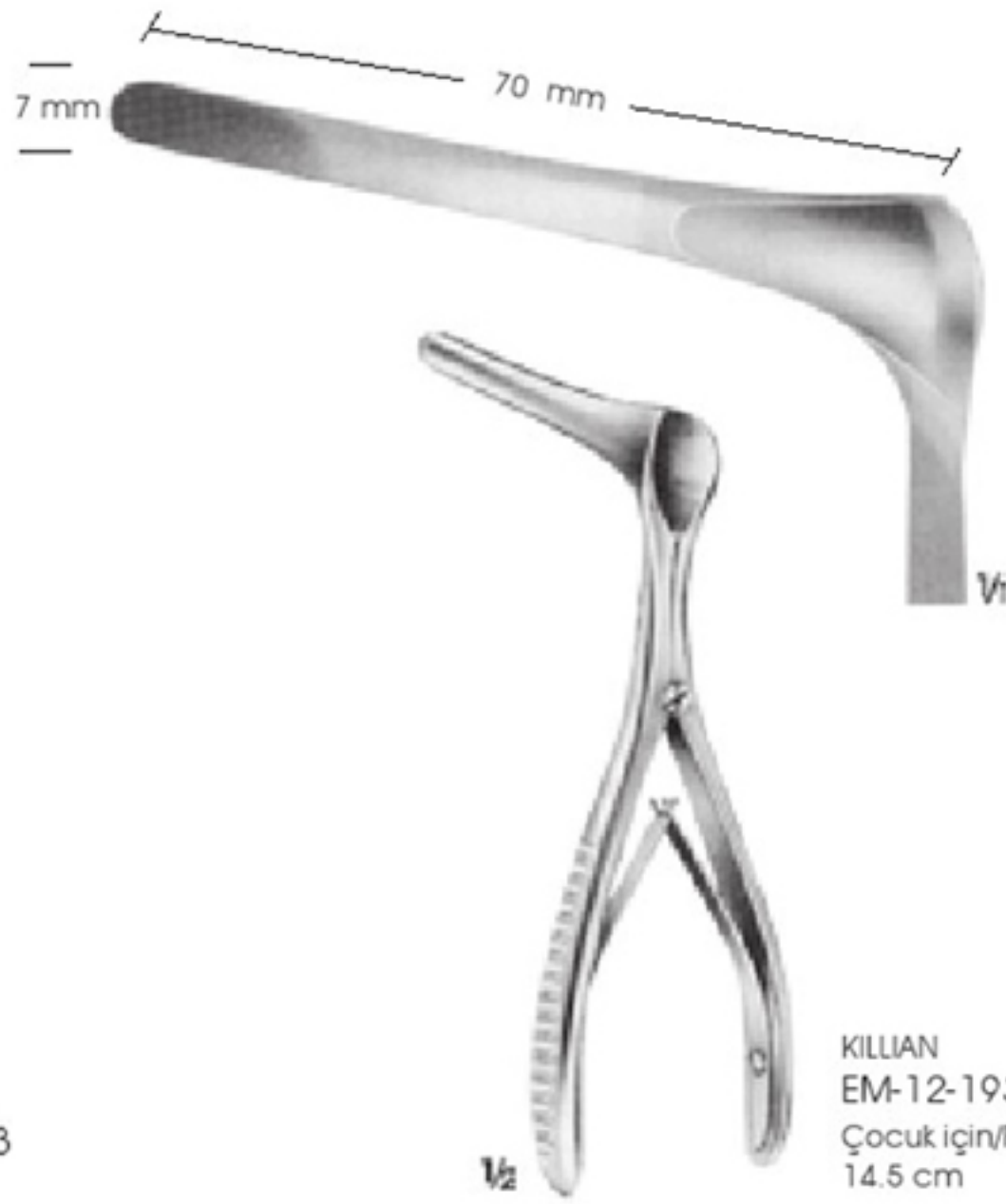

KILLIAN
EM-12-1934
Çocuk için/For children
14.5 cm

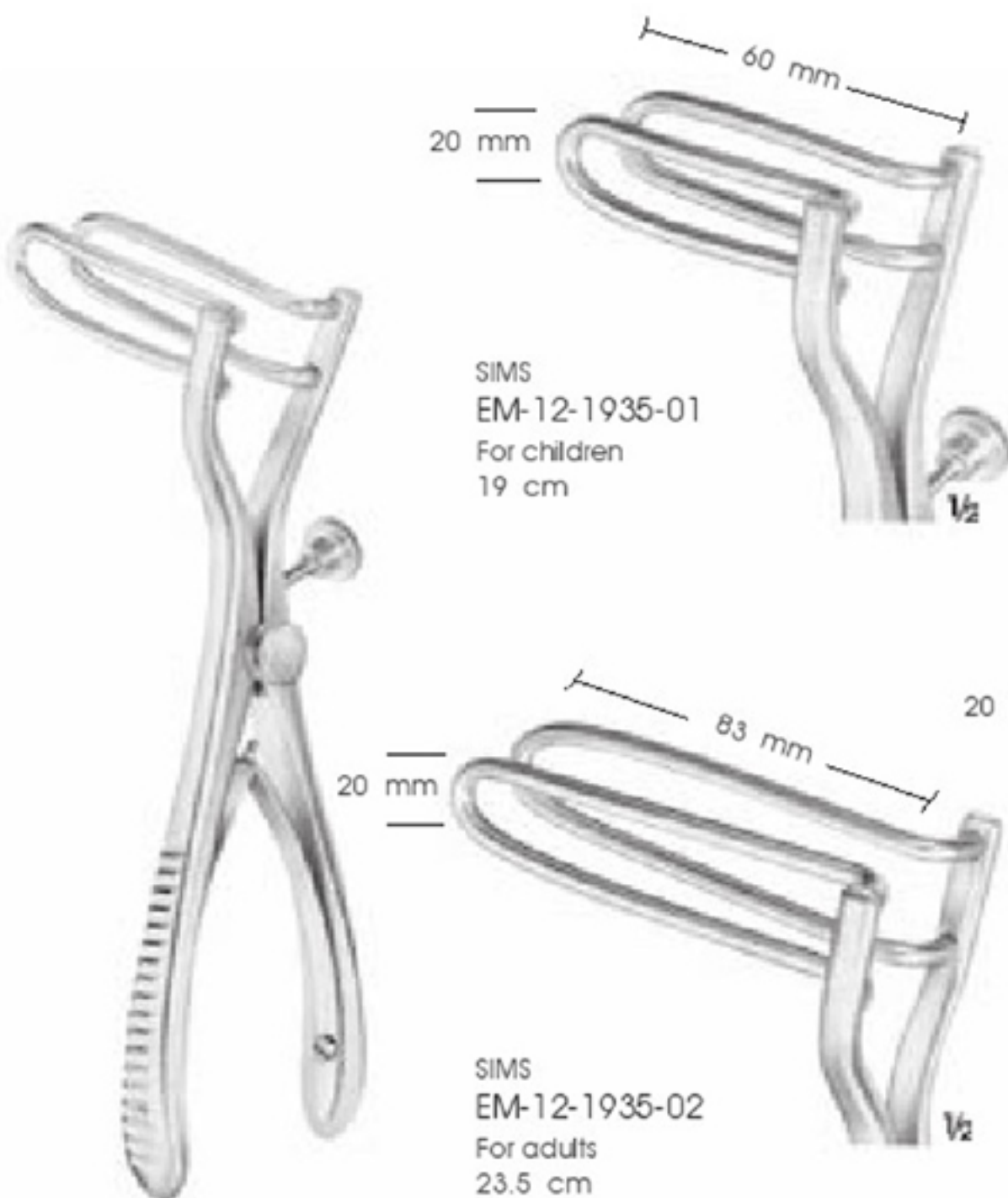

SIMS
EM-12-1935-01
For children
19 cm

SIMS
EM-12-1935-02
For adults
23.5 cm

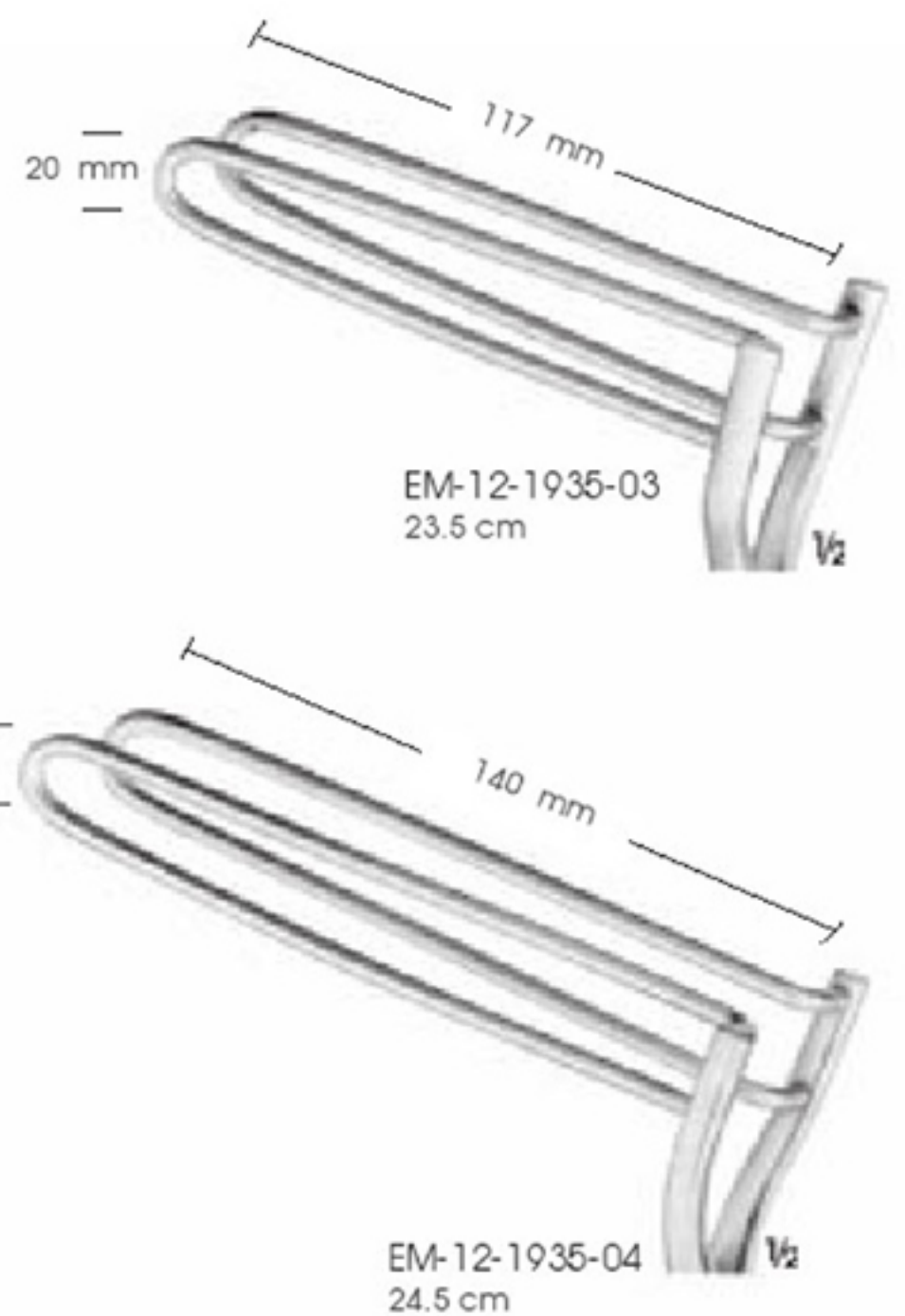

EM-12-1935-03
23.5 cm

EM-12-1935-04
24.5 cm



SIMS
EM-12-1936
16 cm



SIMS
EM-12-1937
16 cm



PRATT
EM-12-1938
20.5 cm

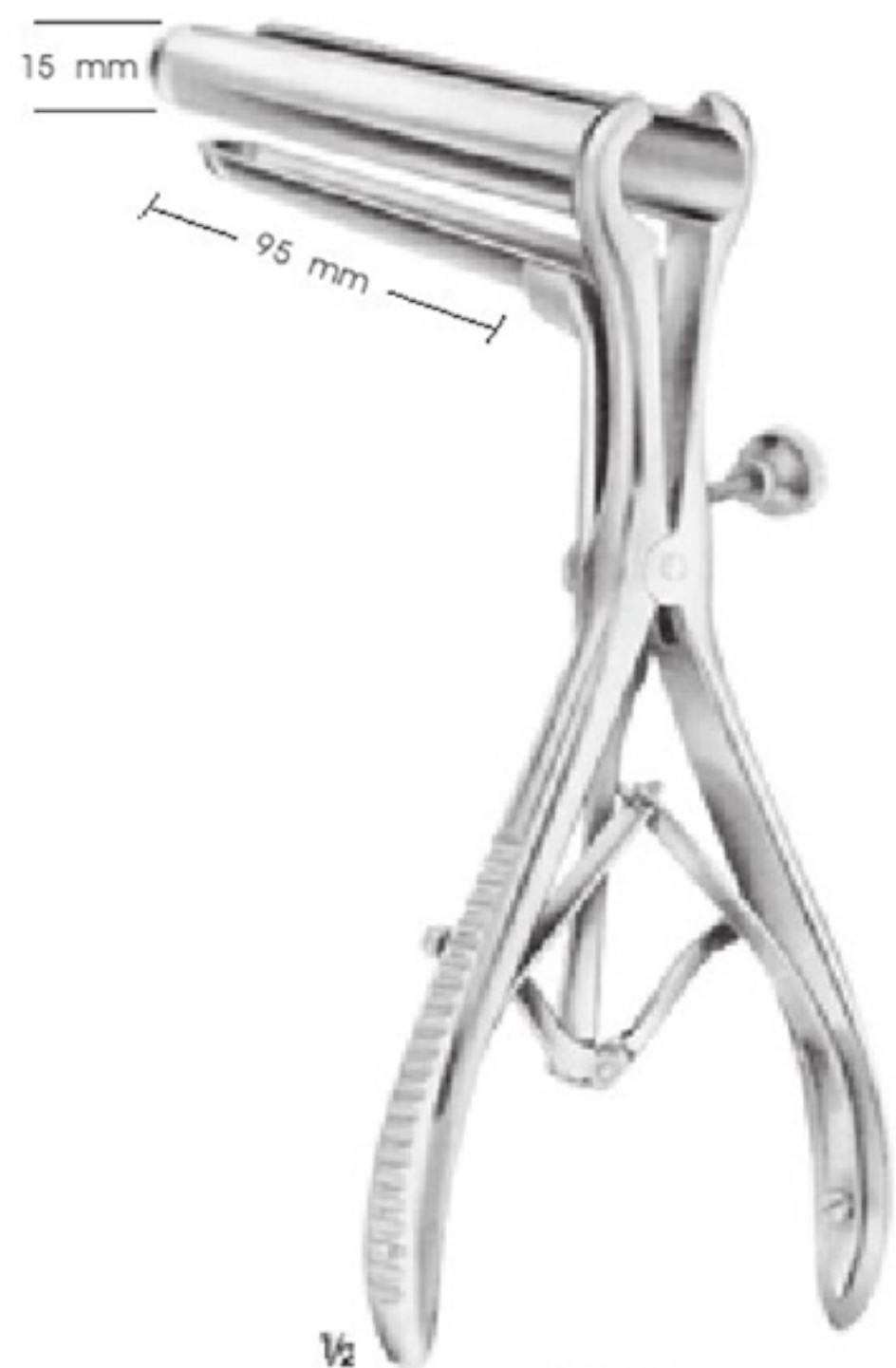

MATHIEU
EM-12-1939
21.5 cm



1/2

SIMS
EM-12-1940
15 cm



100 x 10 mm

1/2

COCK
EM-12-1941
19 cm



HIRSCHMANN
EM-12-1942-01 Ø 16 x 65 mm
EM-12-1942-02 Ø 19 x 65 mm
EM-12-1942-03 Ø 22 x 65 mm



KELLY
EM-12-1943-01 Ø 22 x 50 mm
EM-12-1943-02 Ø 22 x 100 mm
EM-12-1943-03 Ø 22 x 140 mm



1/2

BENSAUDE
EM-12-1944-01 Ø 17 mm
EM-12-1944-02 Ø 20 mm
EM-12-1944-03 Ø 23 mm
Anoscopes
18.5 cm



1/2

IVES-FANSLER
EM-12-1945 Ø 24 mm
Anoscope
14.5 cm



1/2

KELLY
EM-12-1946-01 Ø 20 mm
Anoscope
16 cm



1/2

KELLY
EM-12-1946-02 Ø 25 mm
Sphincteroscope
16 cm



$\frac{1}{2}$
 KELY
 EM-12-1947
 Proctoscope
 14 cm



$\frac{1}{1}$
 EM-12-1948-06
 ACM/British standard
 for NAUNTON-MORGAN specula

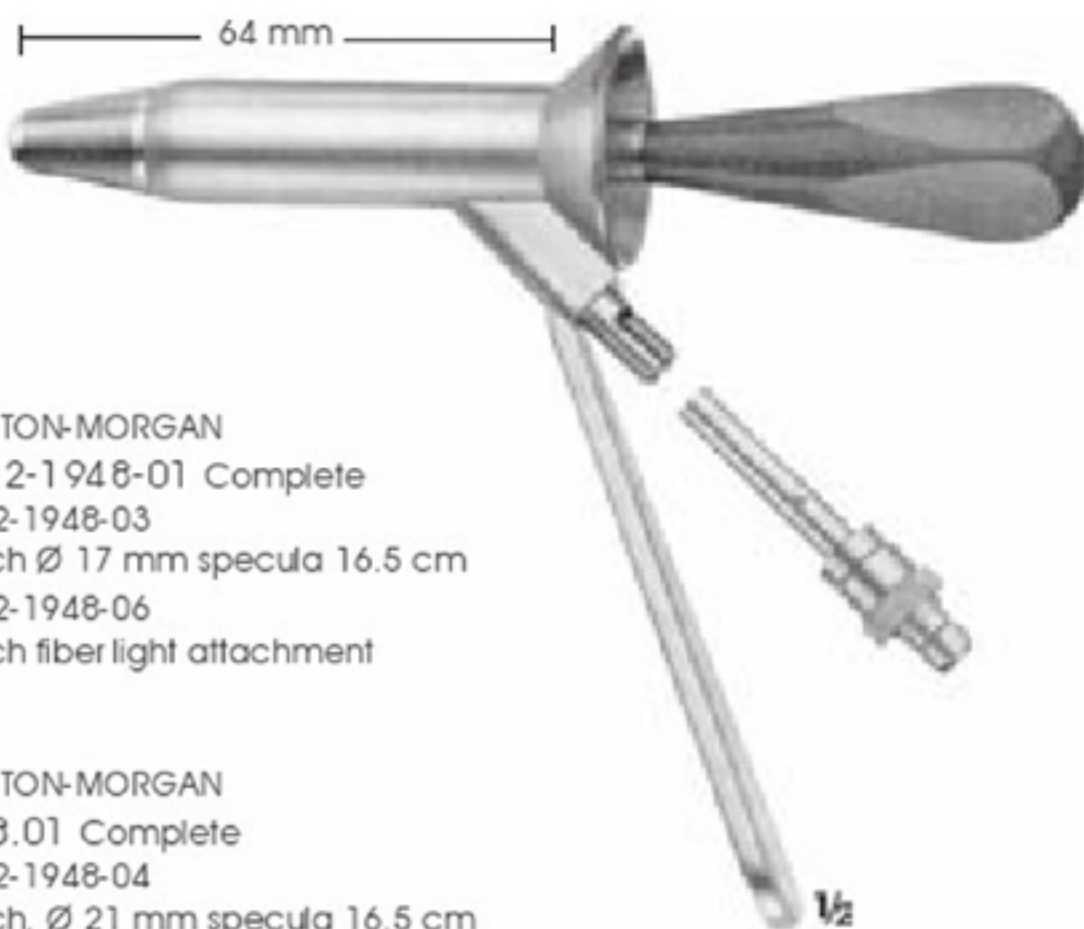

NAUNTON-MORGAN
 EM-12-1948-01 Complete
 EM-12-1948-03
 1 each \varnothing 17 mm specula 16.5 cm
 EM-12-1948-06
 1 each fiber light attachment

NAUNTON-MORGAN
 L 738.01 Complete
 EM-12-1948-04
 1 each, \varnothing 21 mm specula 16.5 cm
 EM-12-1948-06
 1 each fiber light attachment

NAUNTON-MORGAN
 EM-12-1948-02 Complete
 EM-12-1948-05
 1 each \varnothing 24 mm specula 16.5 cm
 EM-12-1948-06
 1 each fiber light attachment

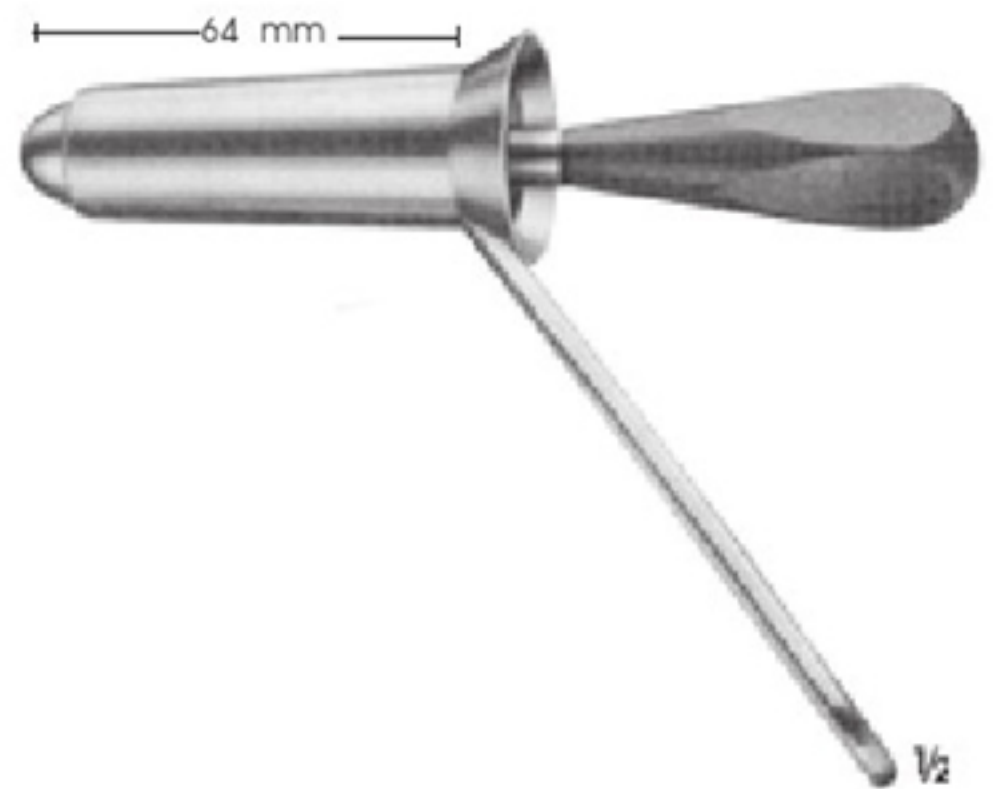

$\frac{1}{2}$
 GABRIEL
 EM-12-1949 \varnothing 25 mm
 Rectal speculum

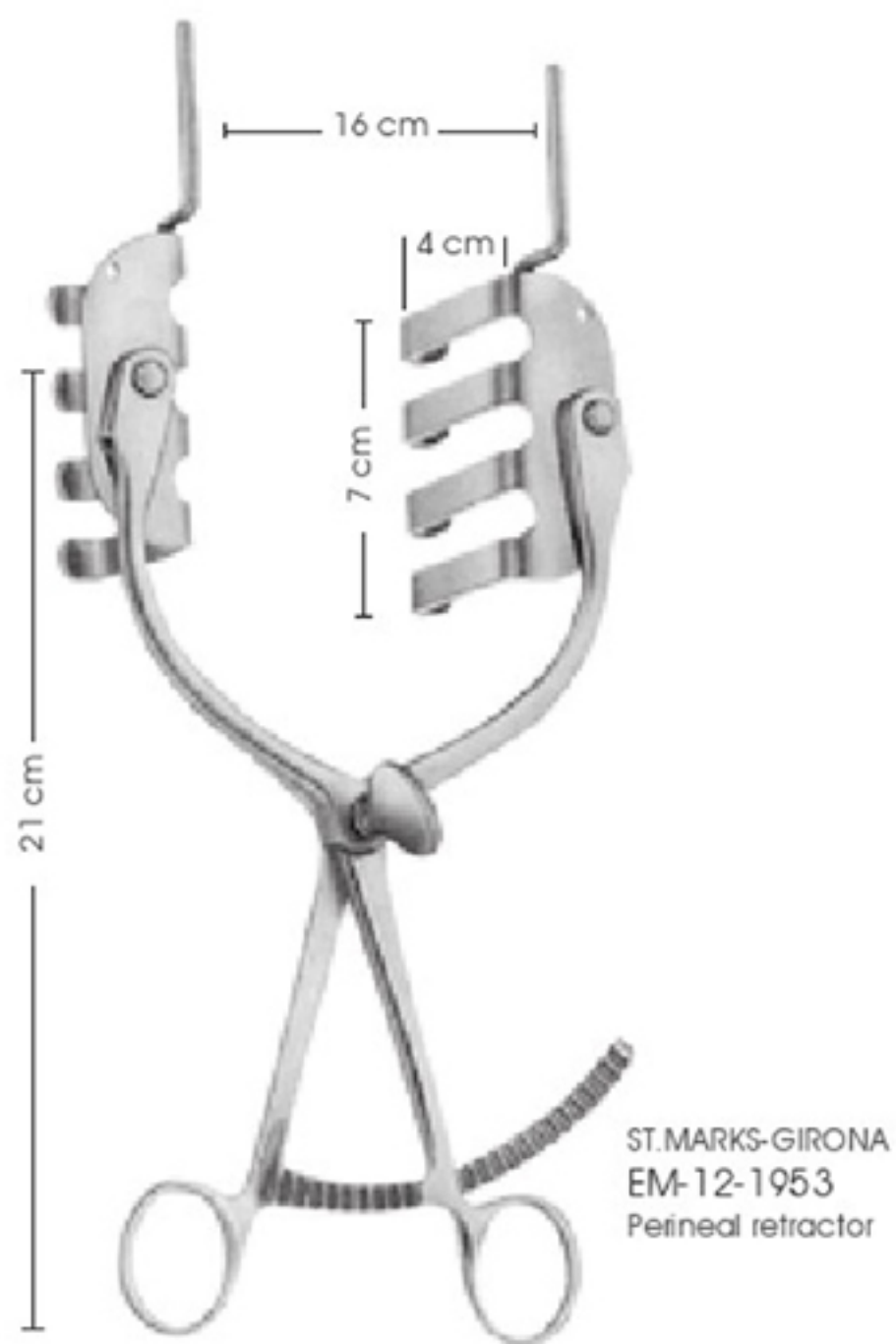
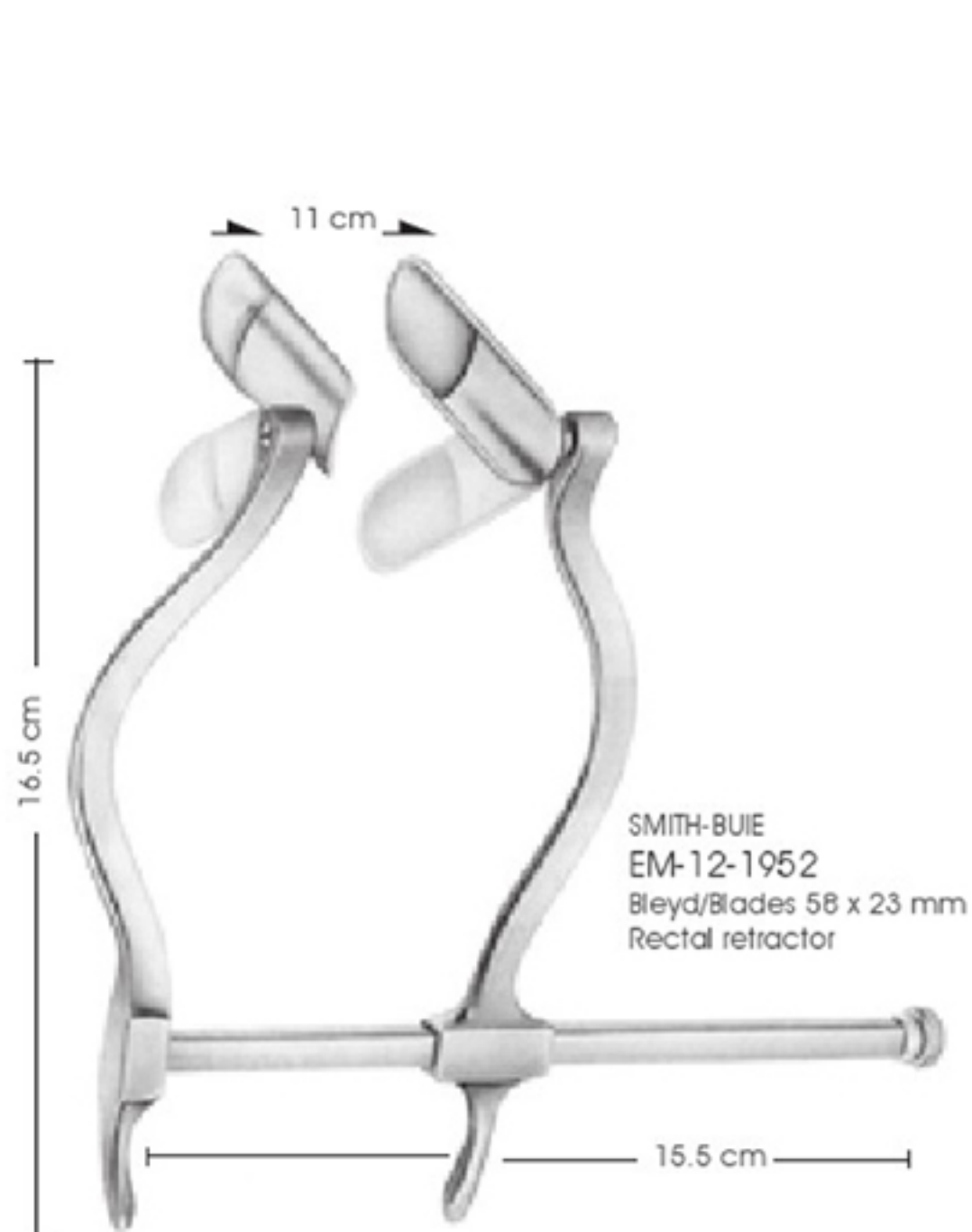
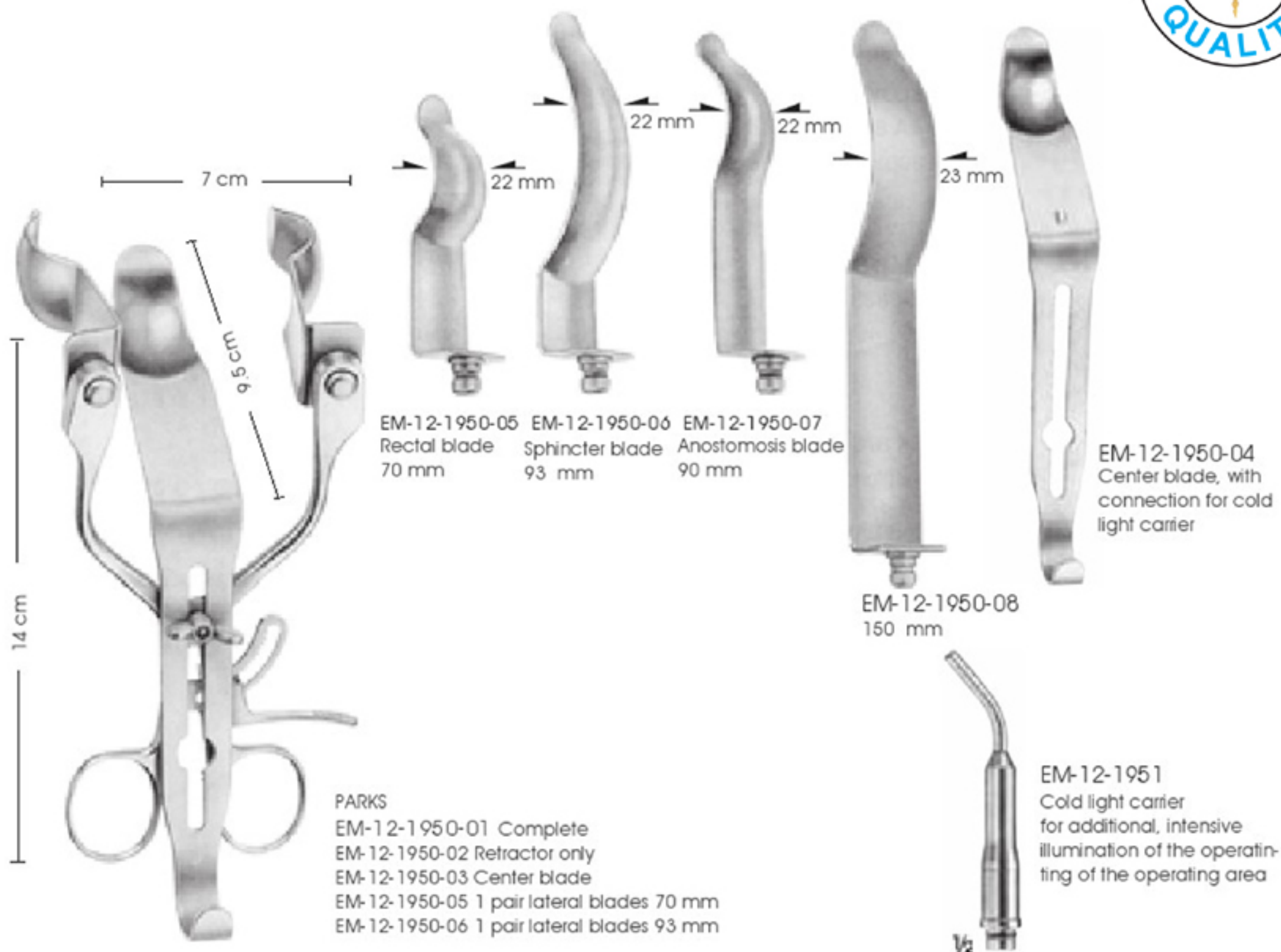

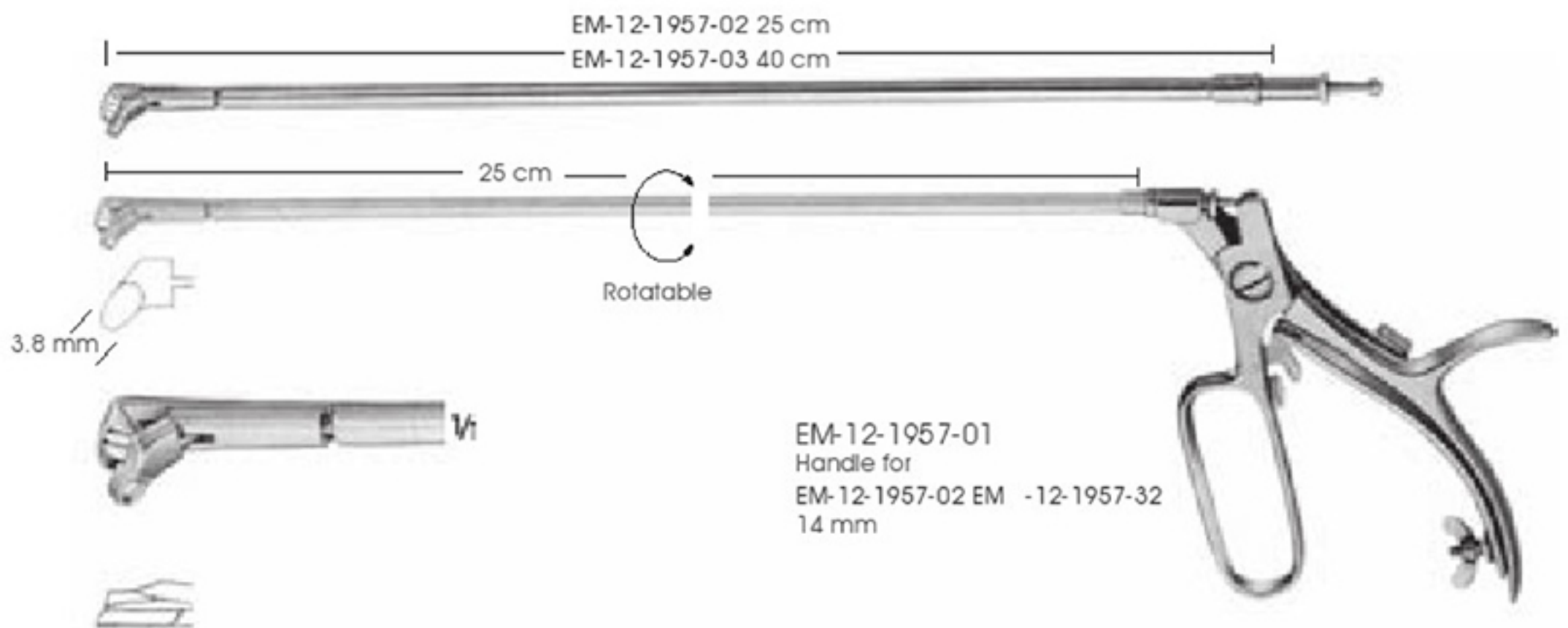
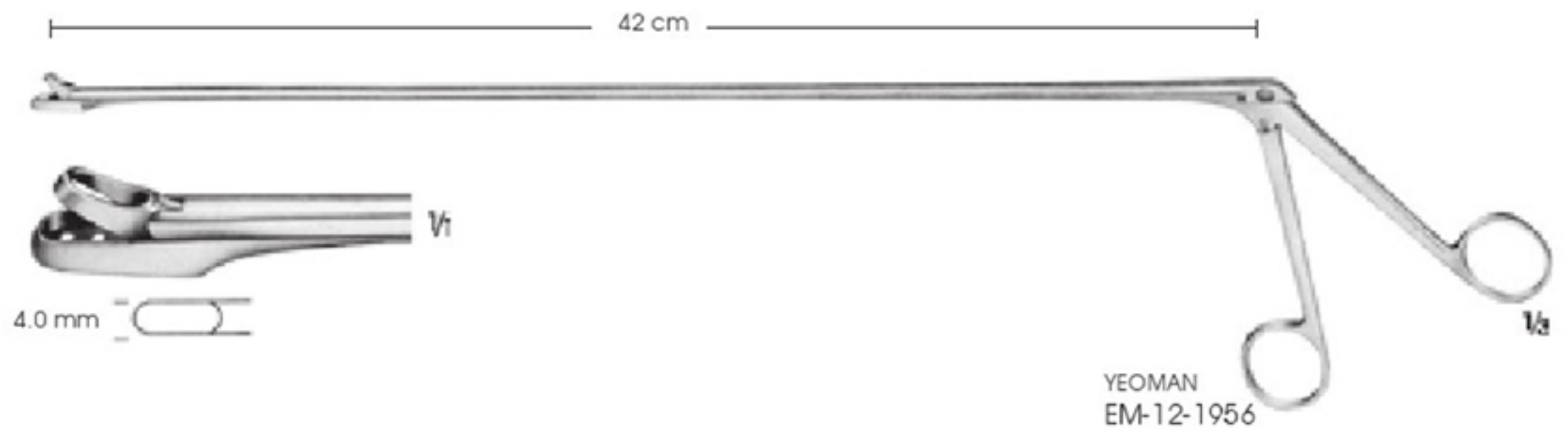
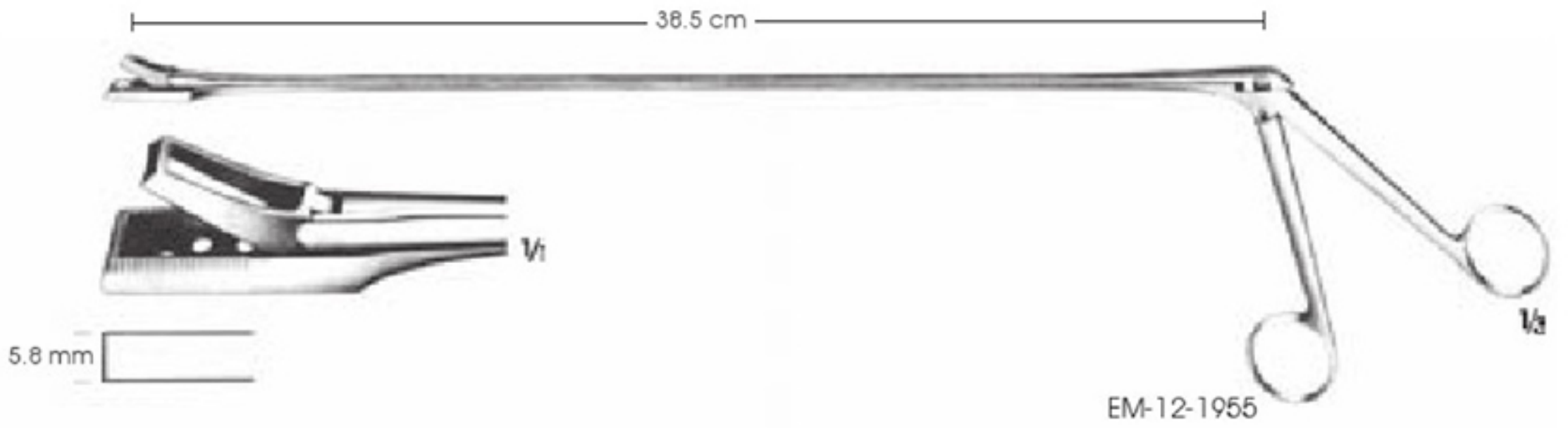
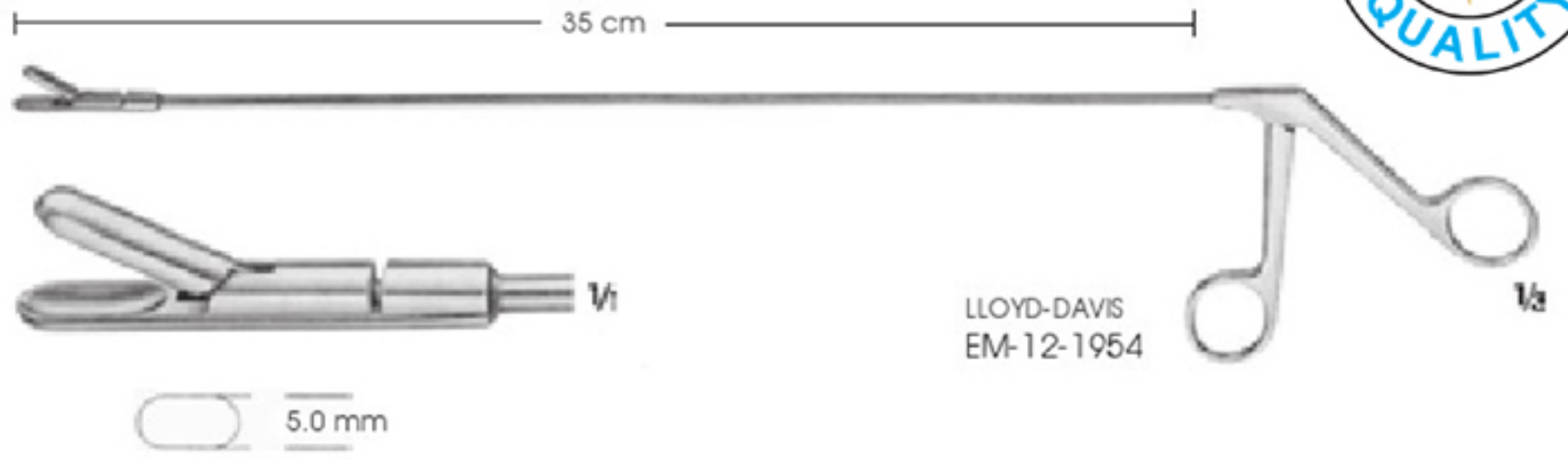

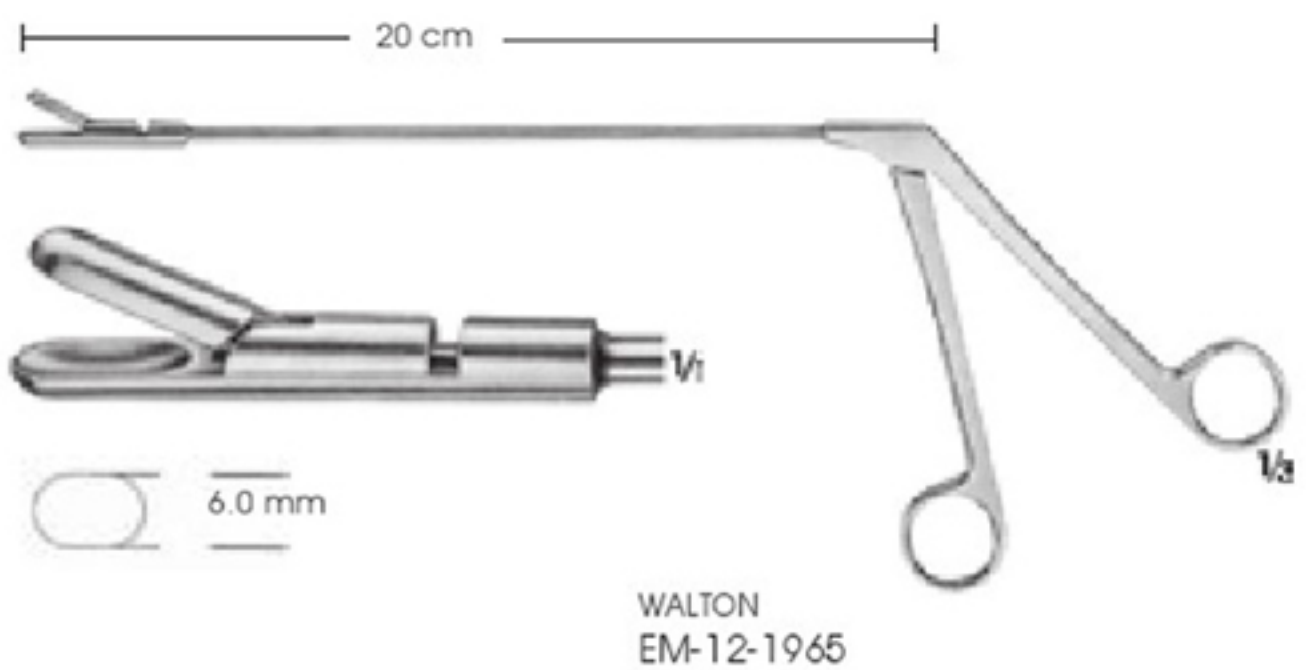
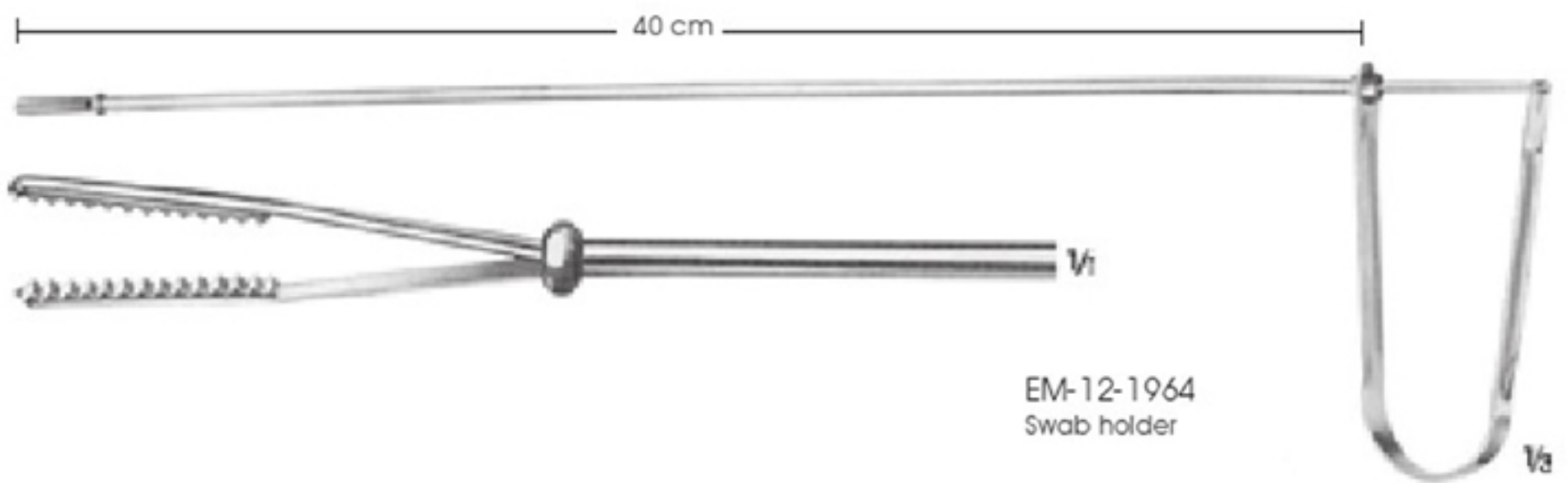
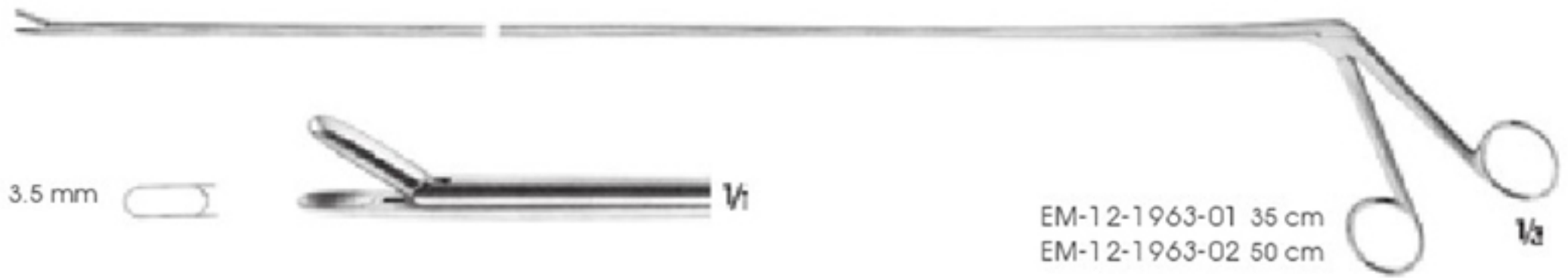
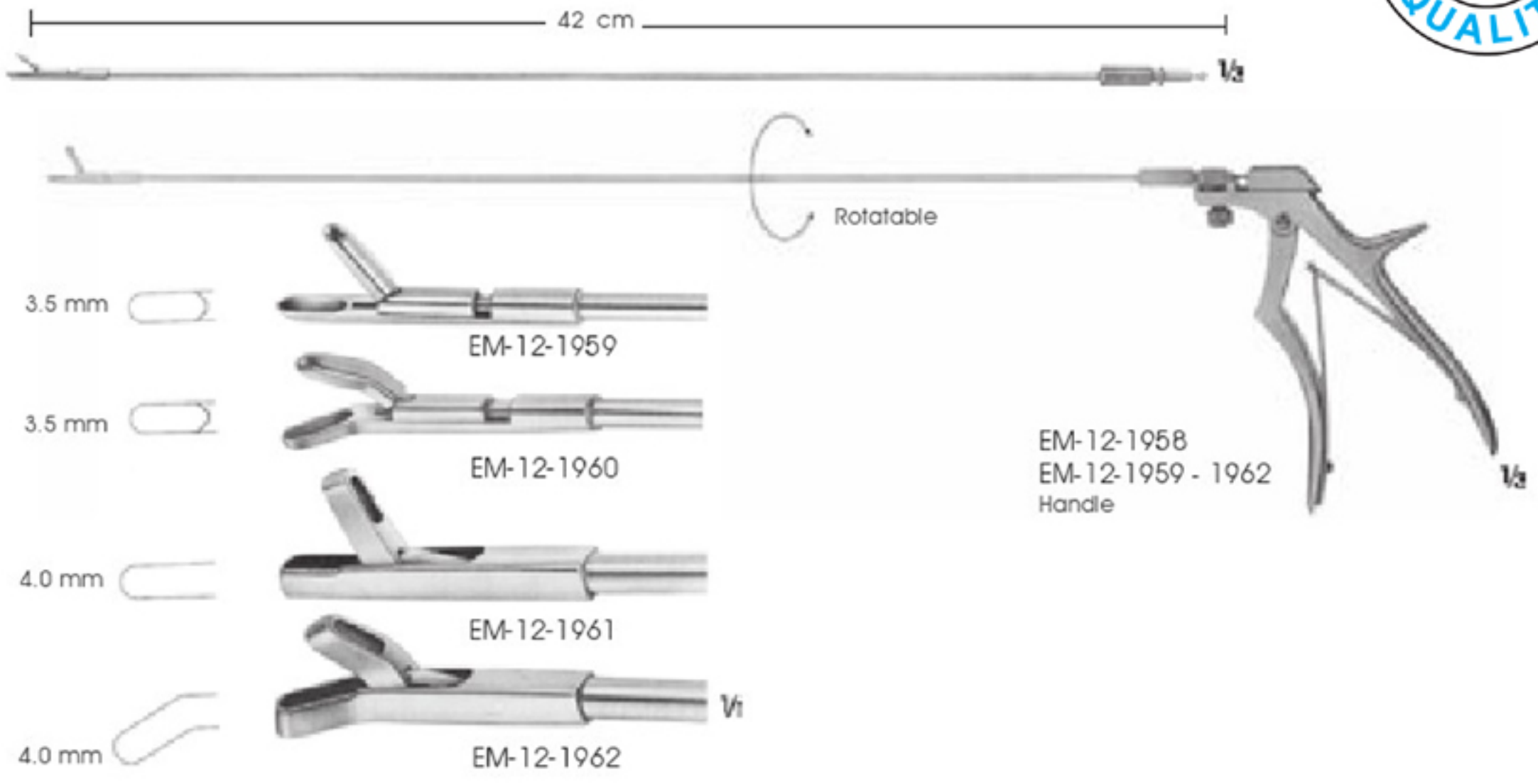



BARRON
EM-12-1966-01 Complete
EM-12-1966-02 /Shaft only
EM-12-1966-03 Universal handle
EM-12-1966-04 Conical loader



MC GIVNEY
EM-12-1967
Hemorrhoidal forceps
18.5 cm



RUDD
EM-12-1968
halkası ile Hemoroid ligatorü
loading attachment and
100 ligature rubber rings
31.5 cm



EM-12-1969
100 Paket
100 Pack

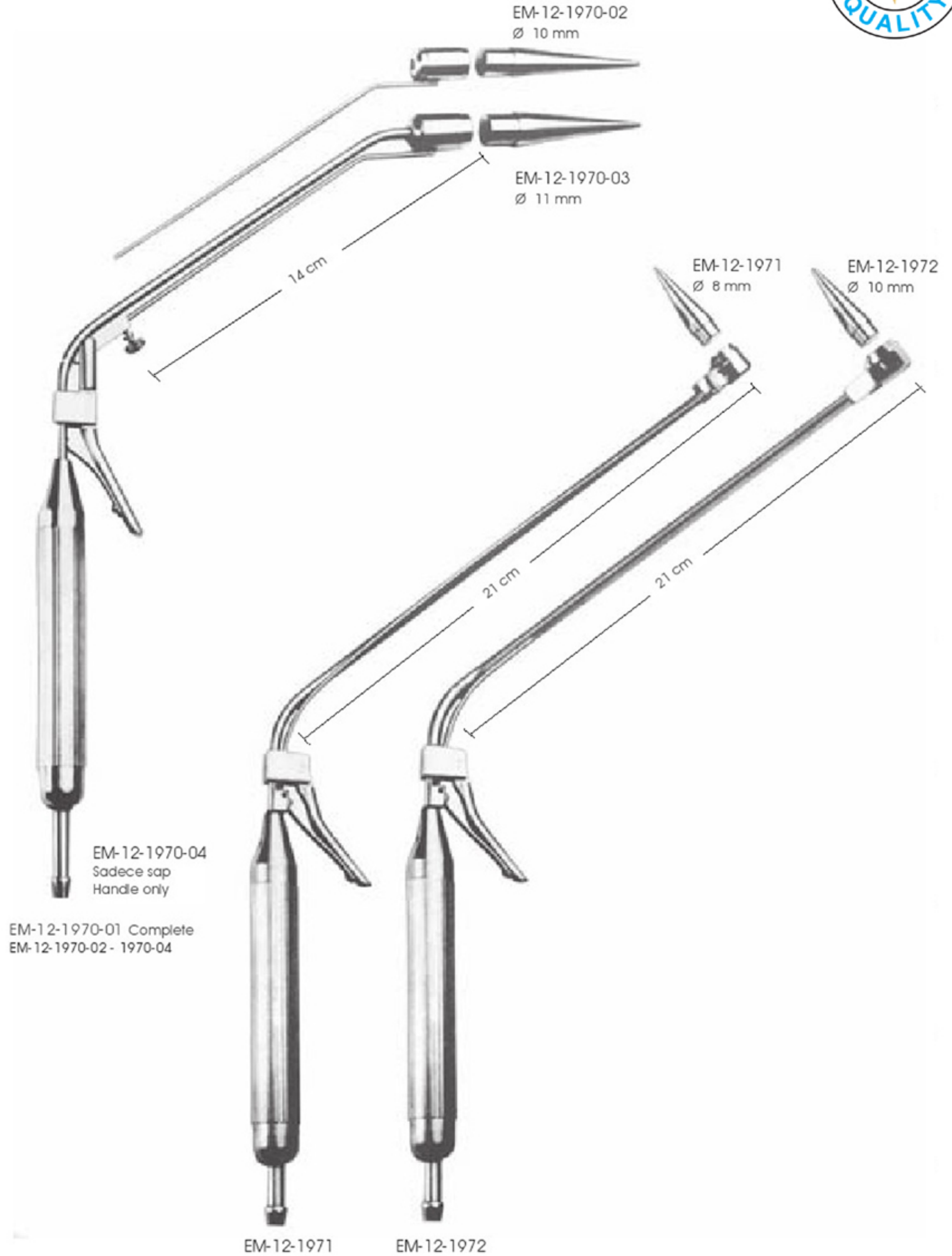

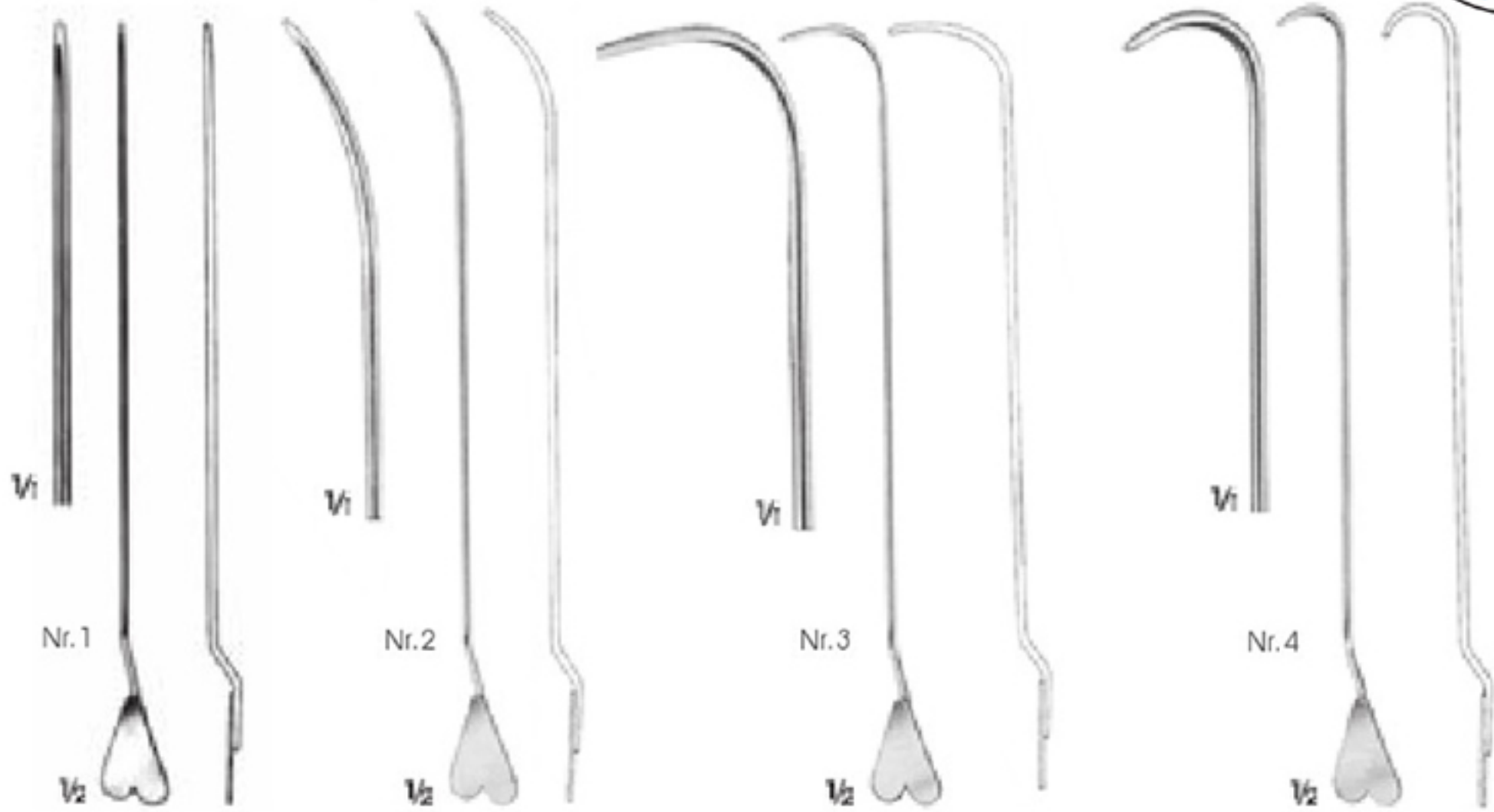

LOCKHART-MUMMERY
Fistul sonda/Fistula probes
EM-12-1973-01 Nr.1 Straight
EM-12-1973-02 Nr.2 45° Curved
EM-12-1973-03 Nr.3 90° Curved
EM-12-1973-04 Nr.4 Curved retrograde
16.5 cm

∅ 3.5 mm



BIRODIE
EM-12-1974
20 cm



EM-12-1975
Malleable
19 cm

∅ 3 mm



EM-12-1976
Double ended probe,
malleable, with hole
19 cm



EM-12-1977
Fistula probe
24 cm

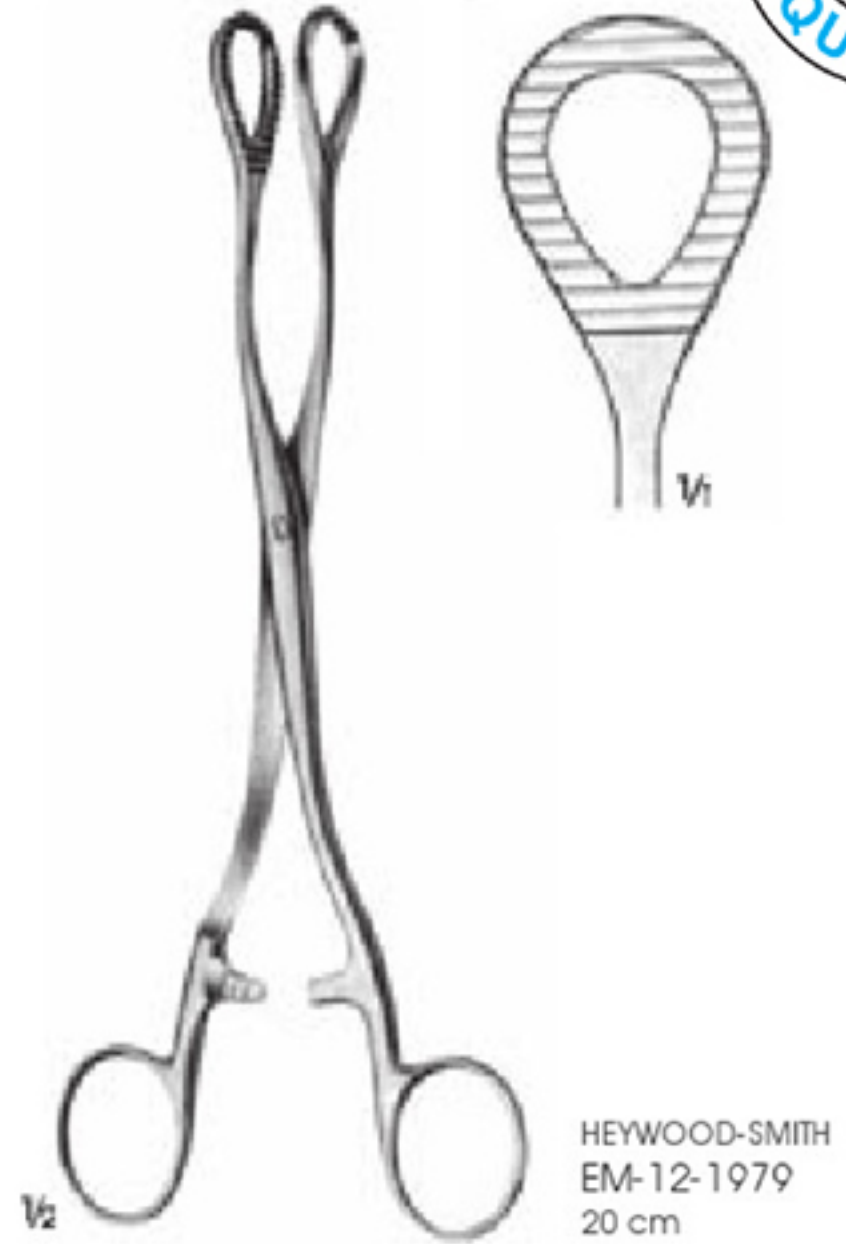

Atraumatic

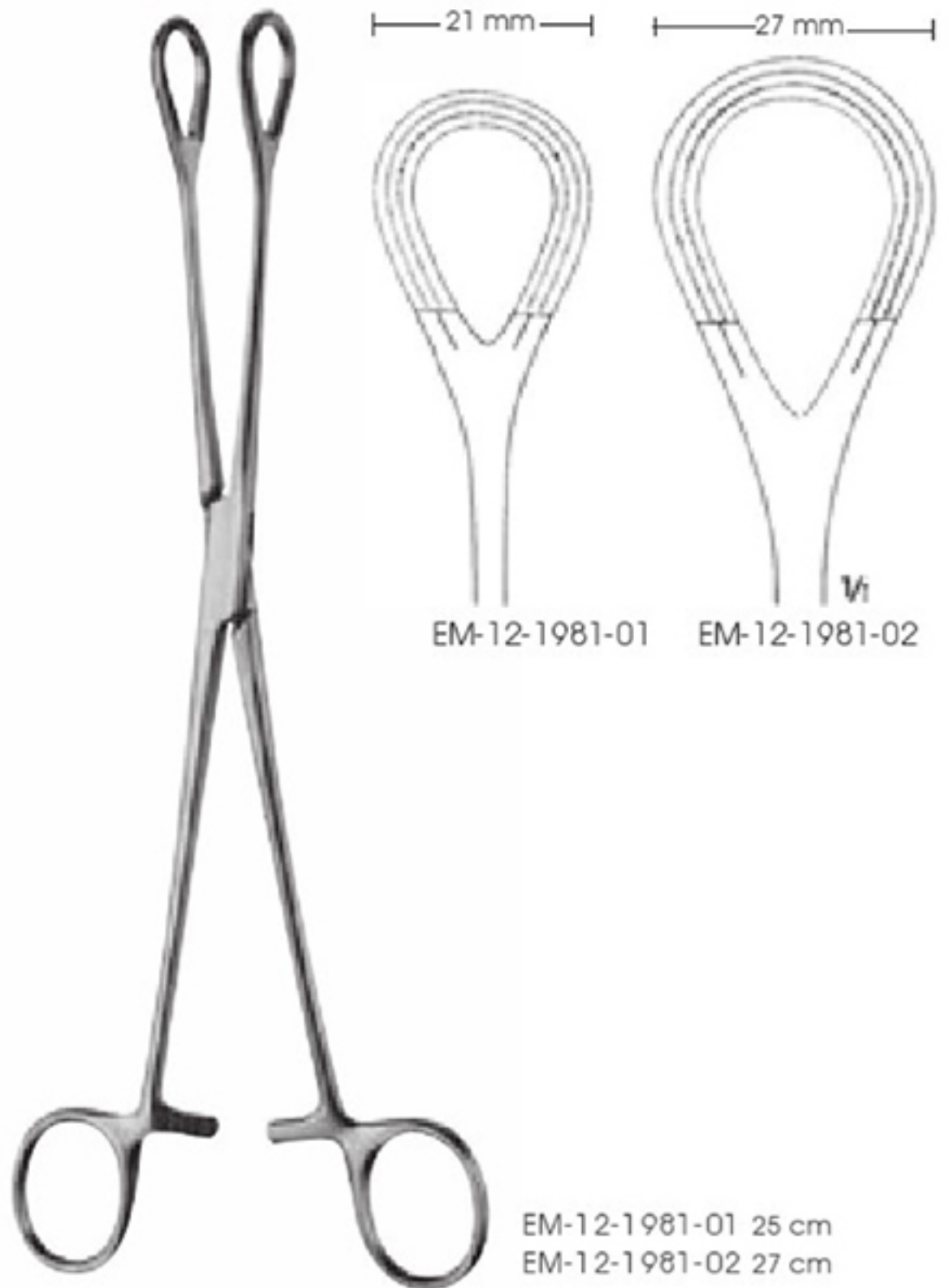
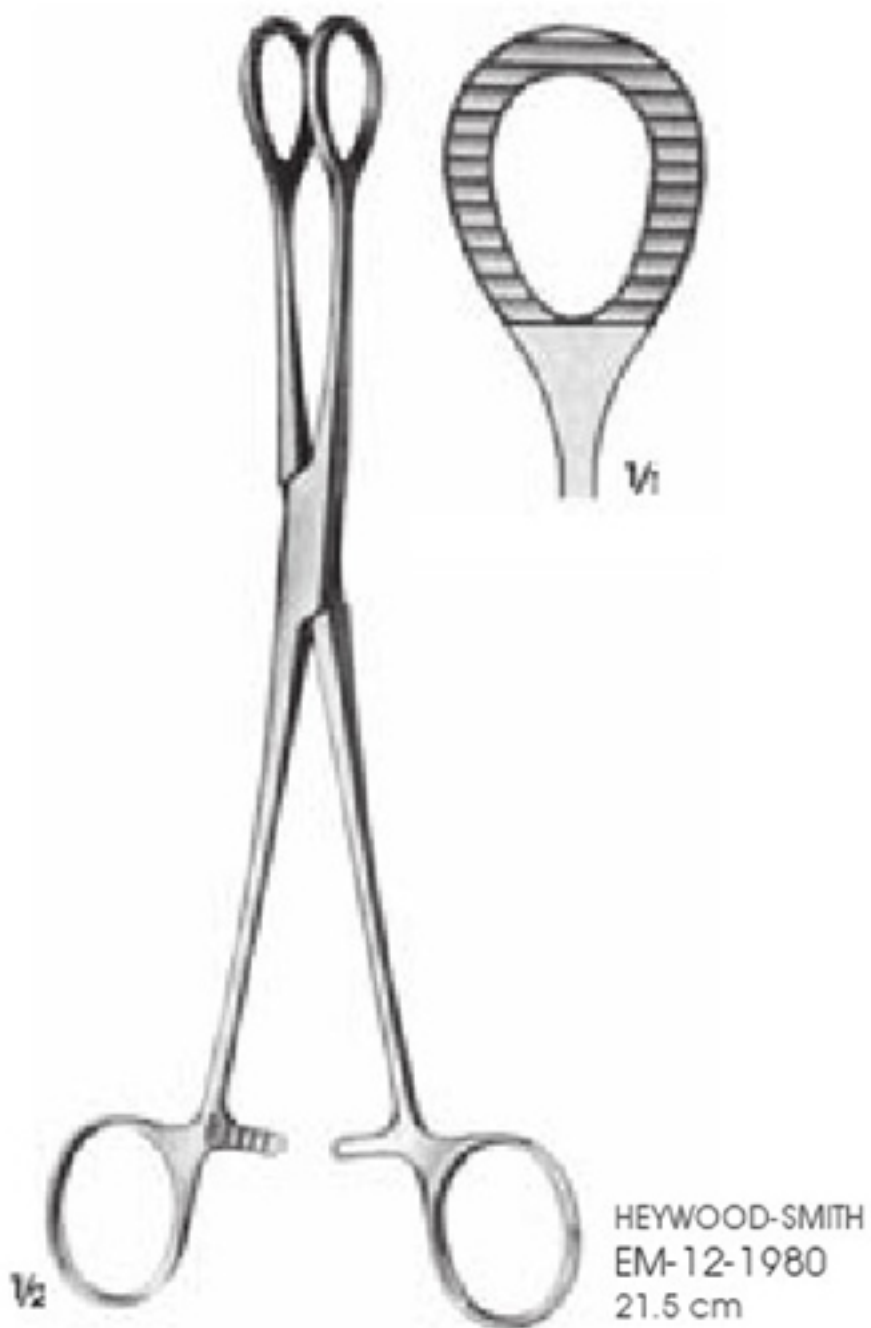

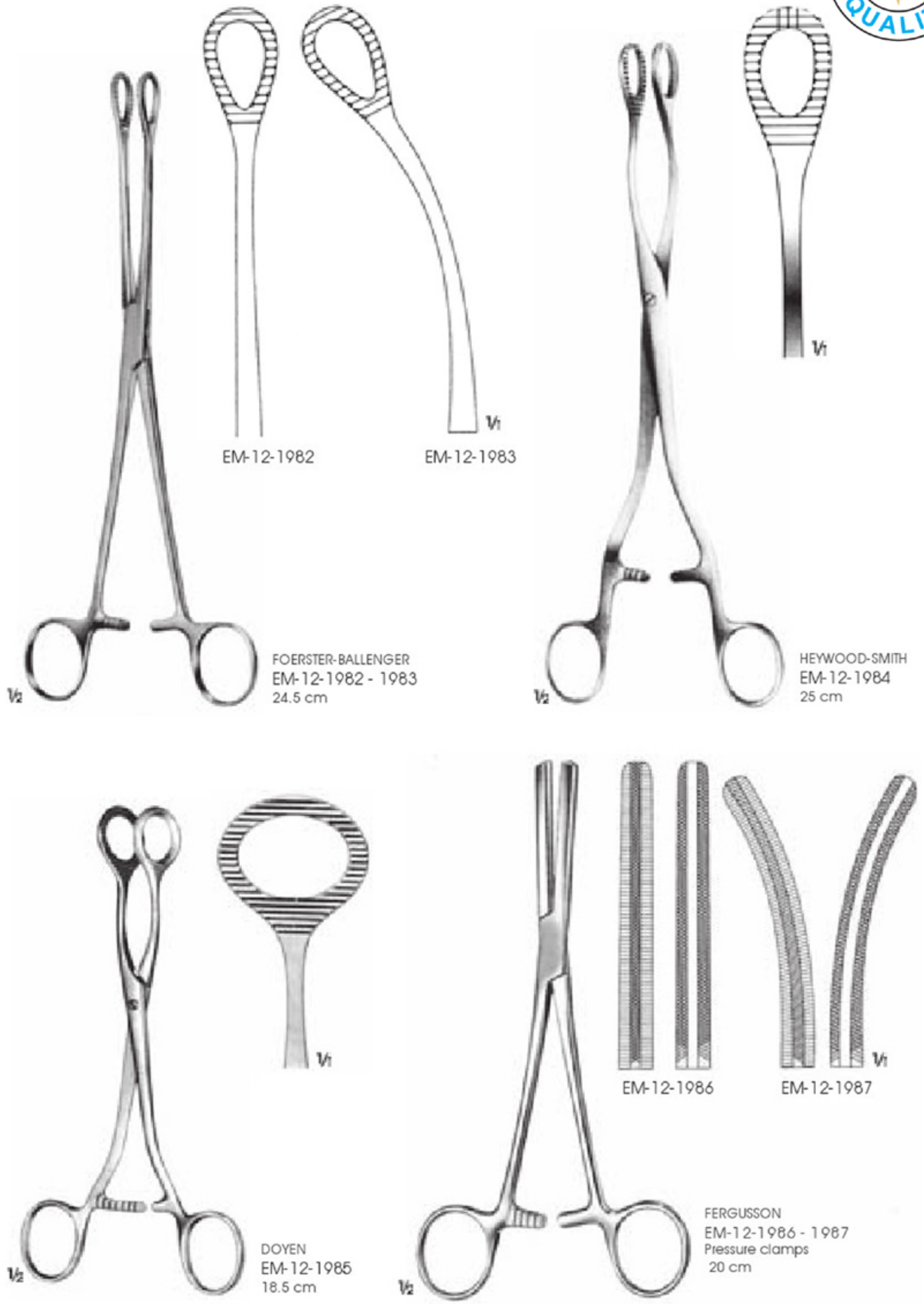

EM-12-1982

EM-12-1983

FOERSTER-BALLENGER
 EM-12-1982 - 1983
 24.5 cm

HEYWOOD-SMITH
 EM-12-1984
 25 cm

DOYEN
 EM-12-1985
 18.5 cm

EM-12-1986

EM-12-1987

FERGUSON
 EM-12-1986 - 1987
 Pressure clamps
 20 cm

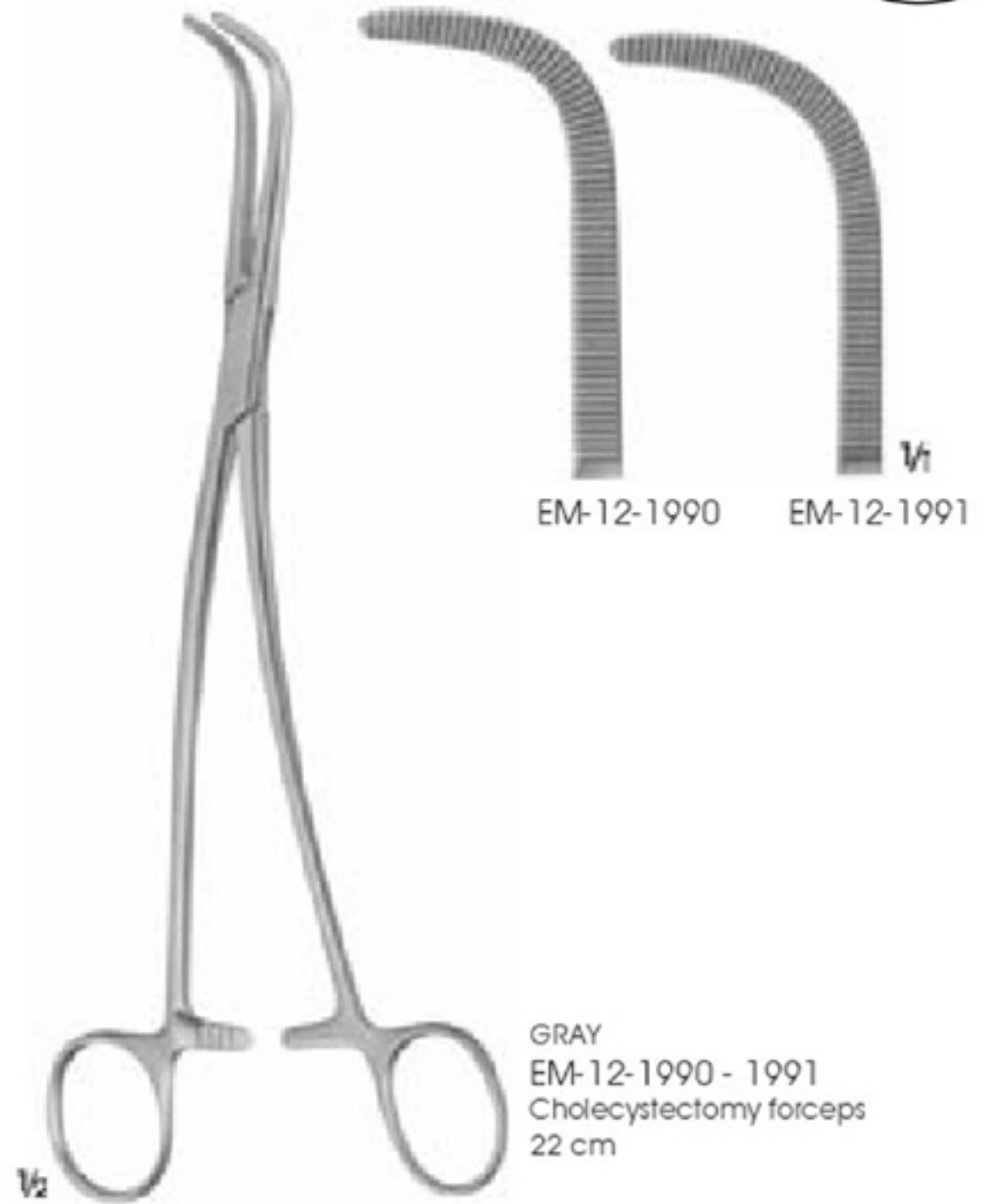
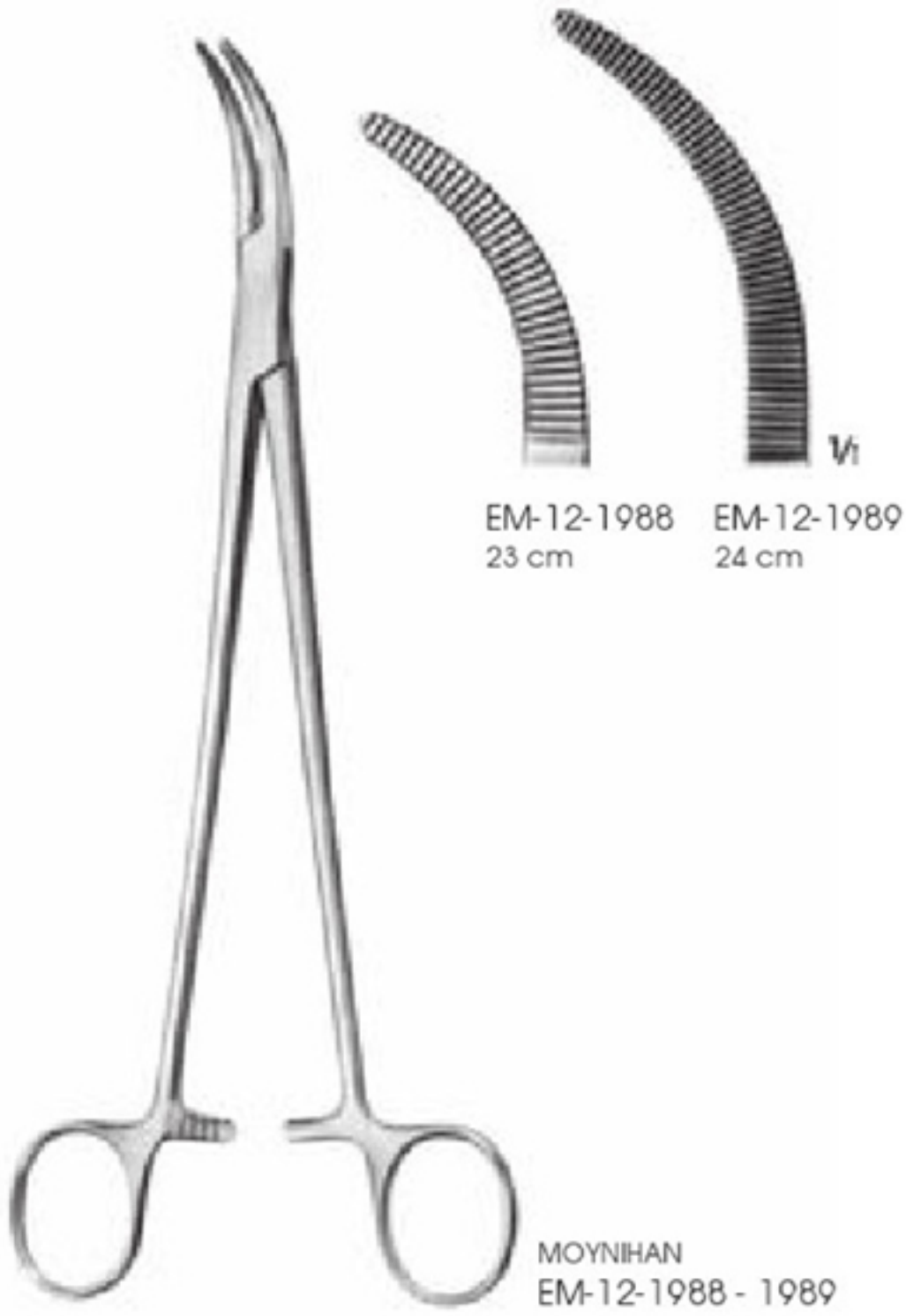

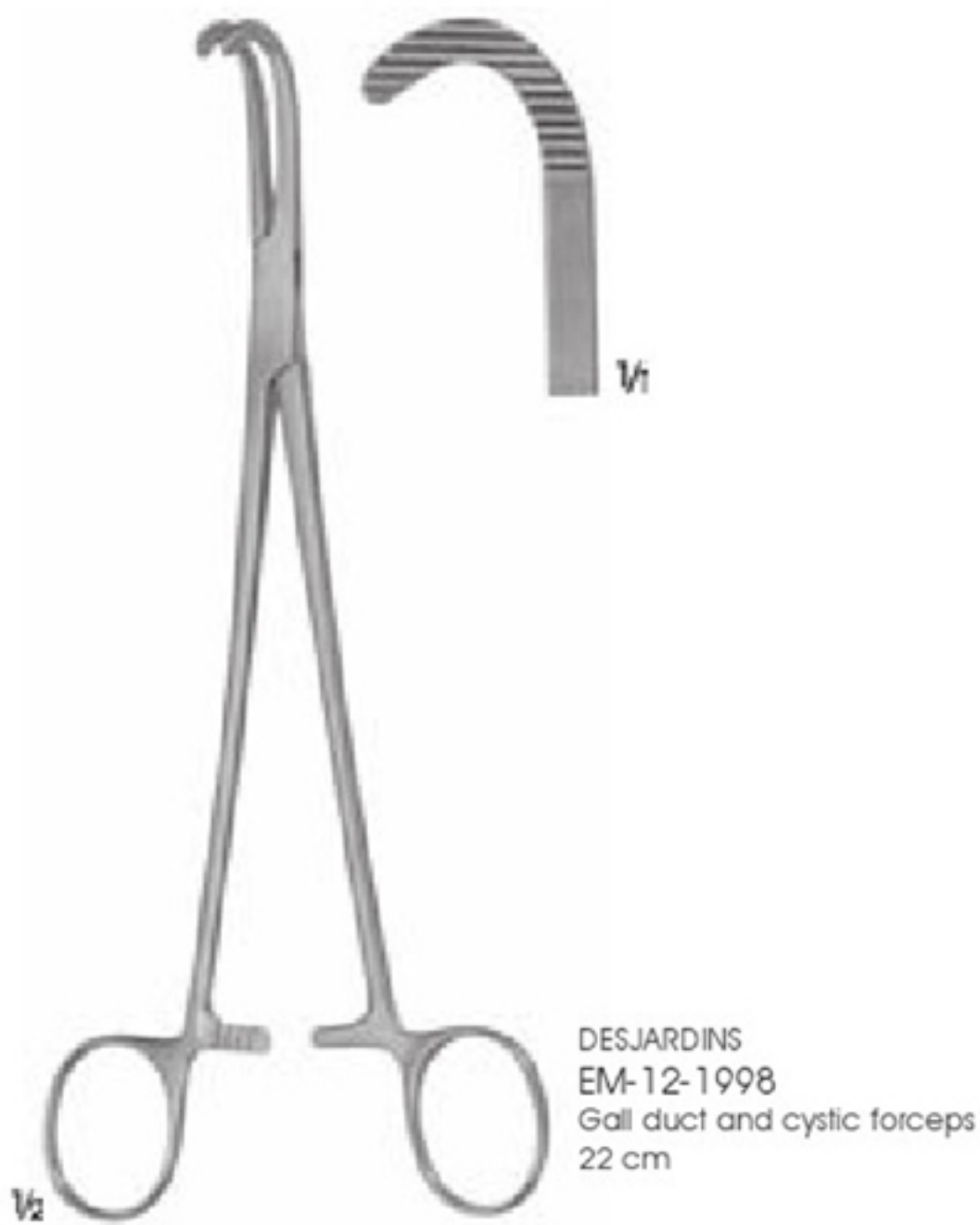
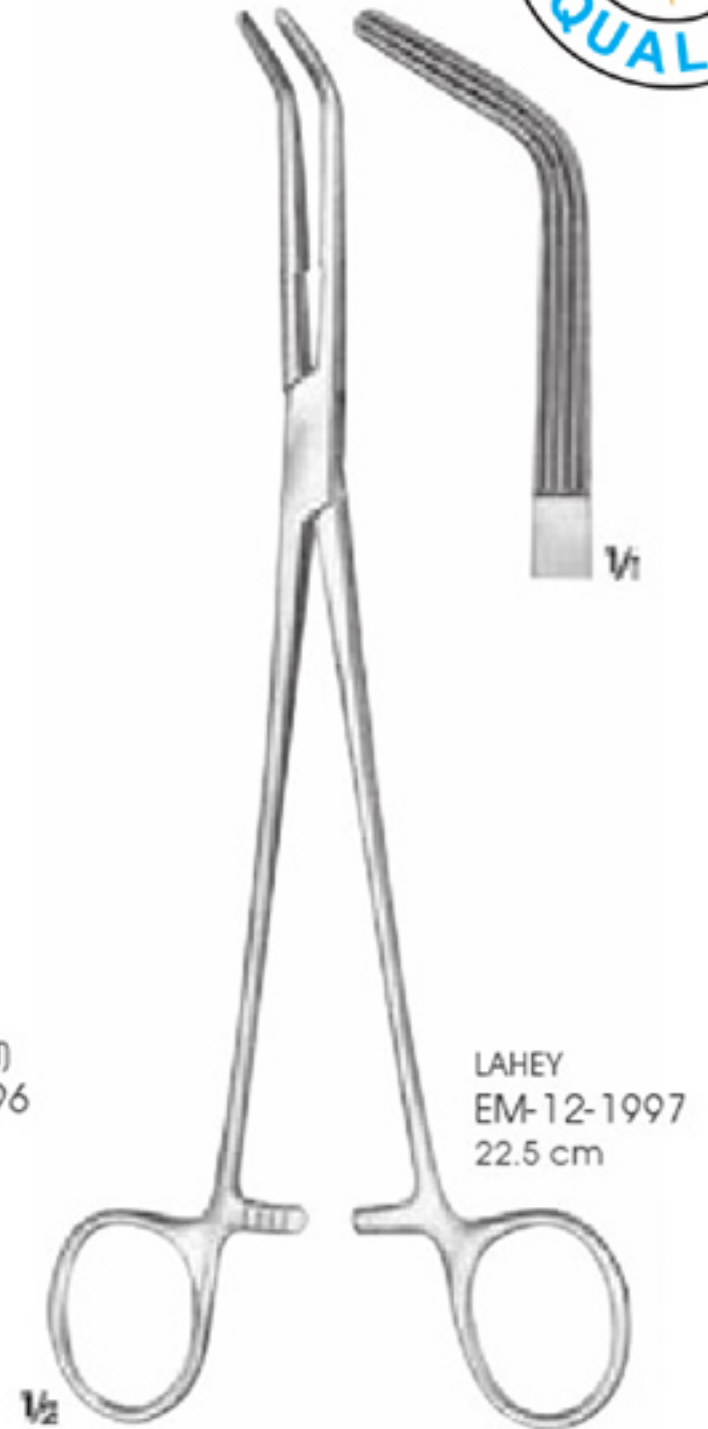
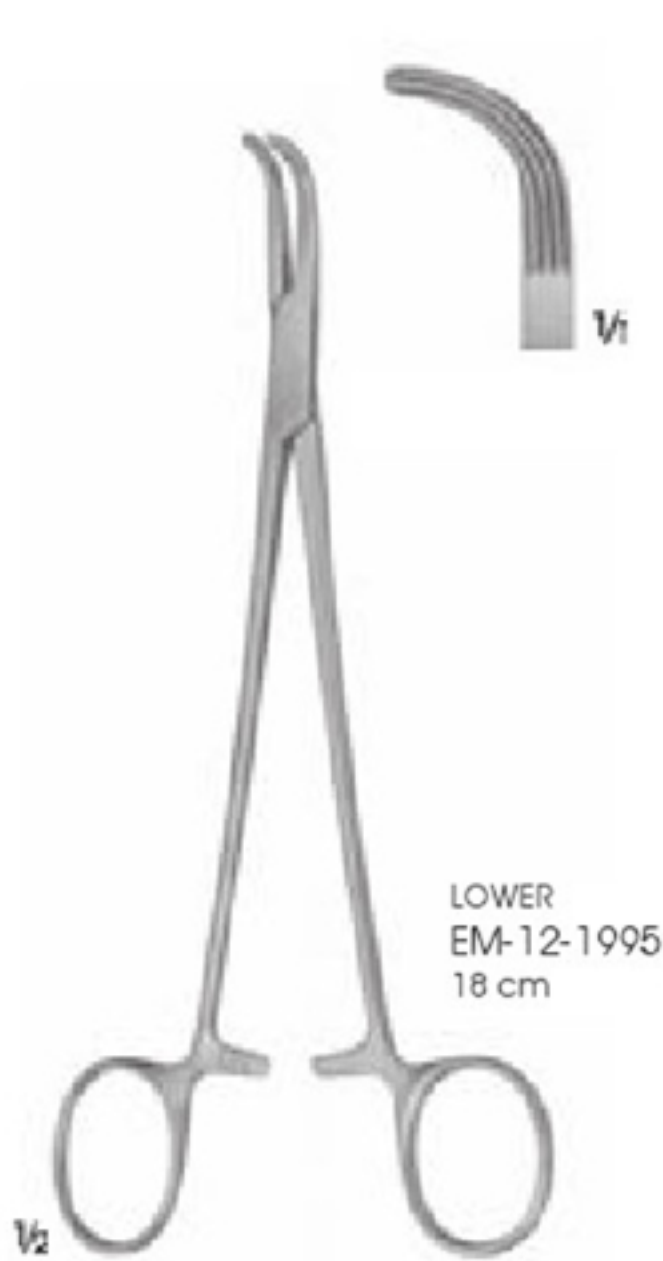



STRULLY
EM-12-2000
Sharp
22 cm



EM-12-2001 Sharp
For opening the gall
bladder
22.5 cm

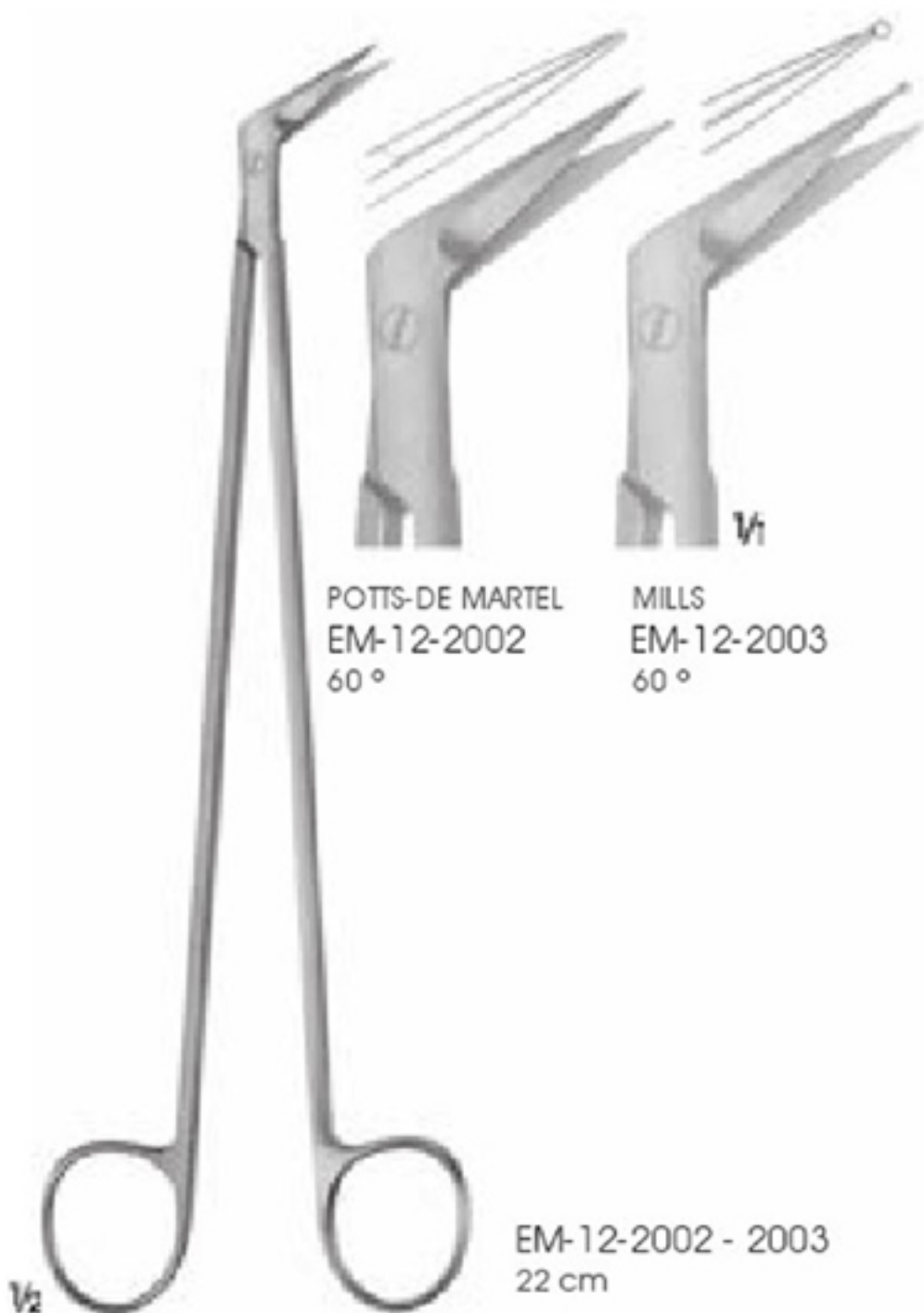

POTTS-DE MARTEL
EM-12-2002
60°

MILLS
EM-12-2003
60°

EM-12-2002 - 2003
22 cm



HARDTIPS

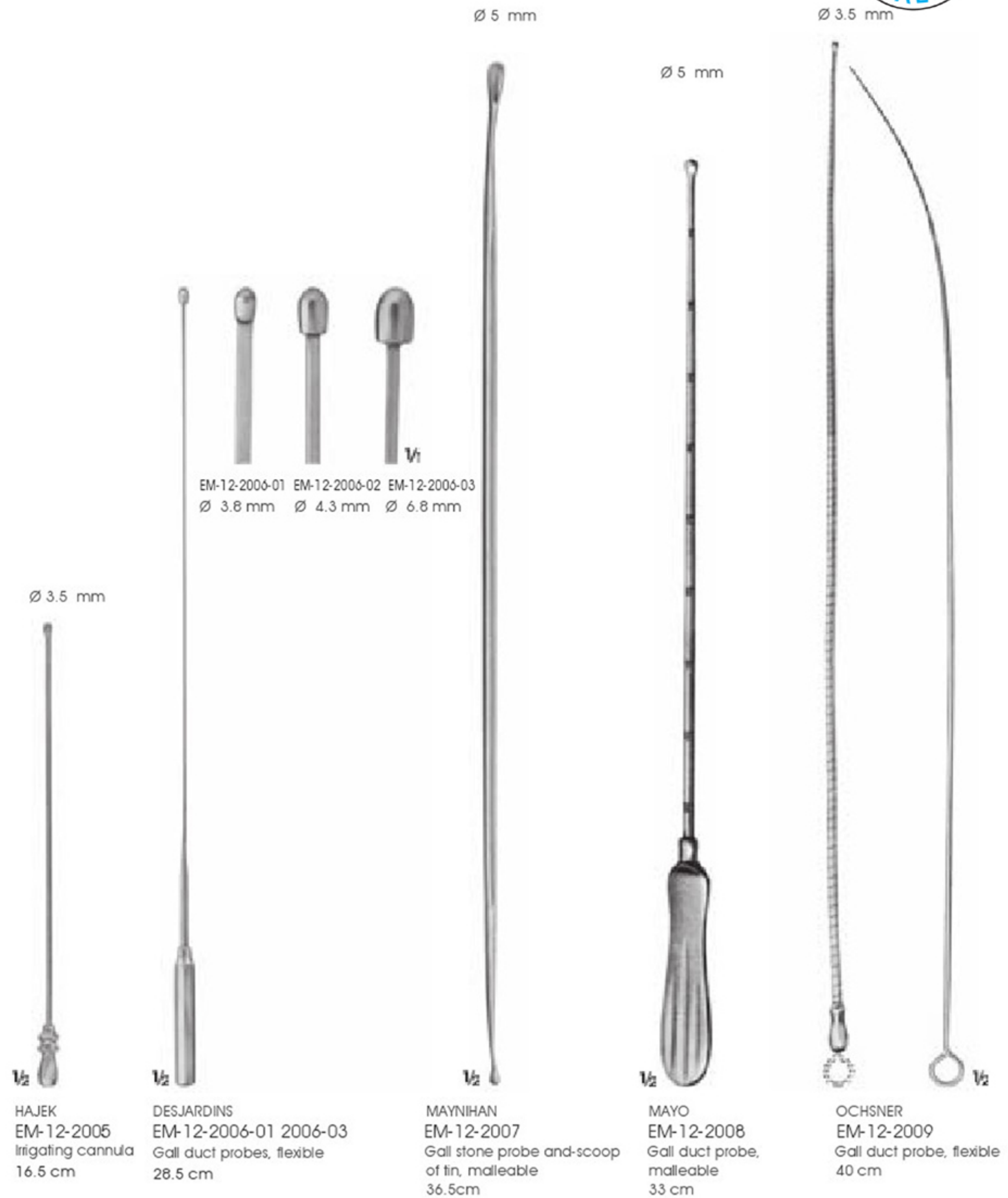

60°

DE BAKKEY
EM-12-2004
22 cm

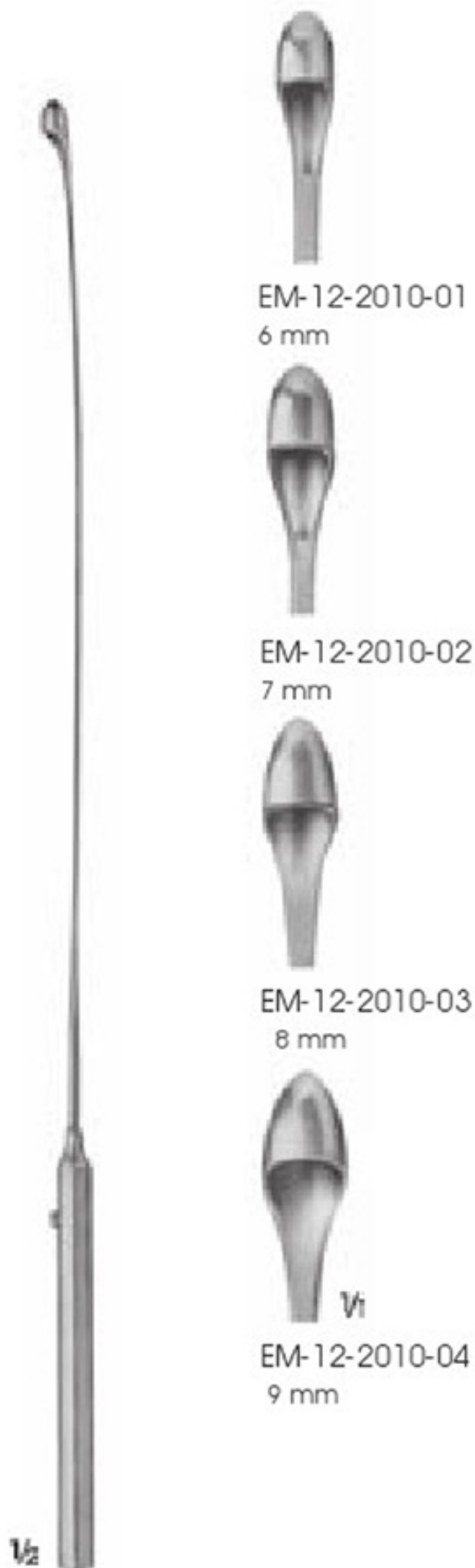

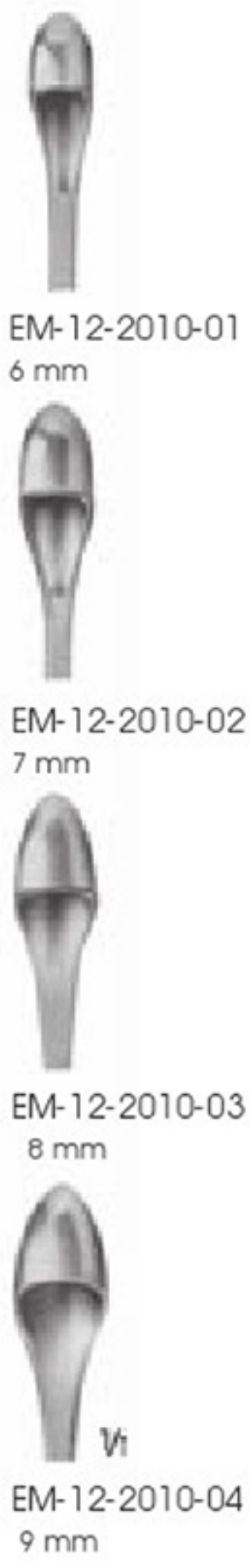

DESJARDINS
EM-12-2010-01 - 2010-04
Probe and catch with flexible shaft
30 cm



LUER-KÖRTE
EM-12-2011-01 - 2011-08
Malleable
31 cm

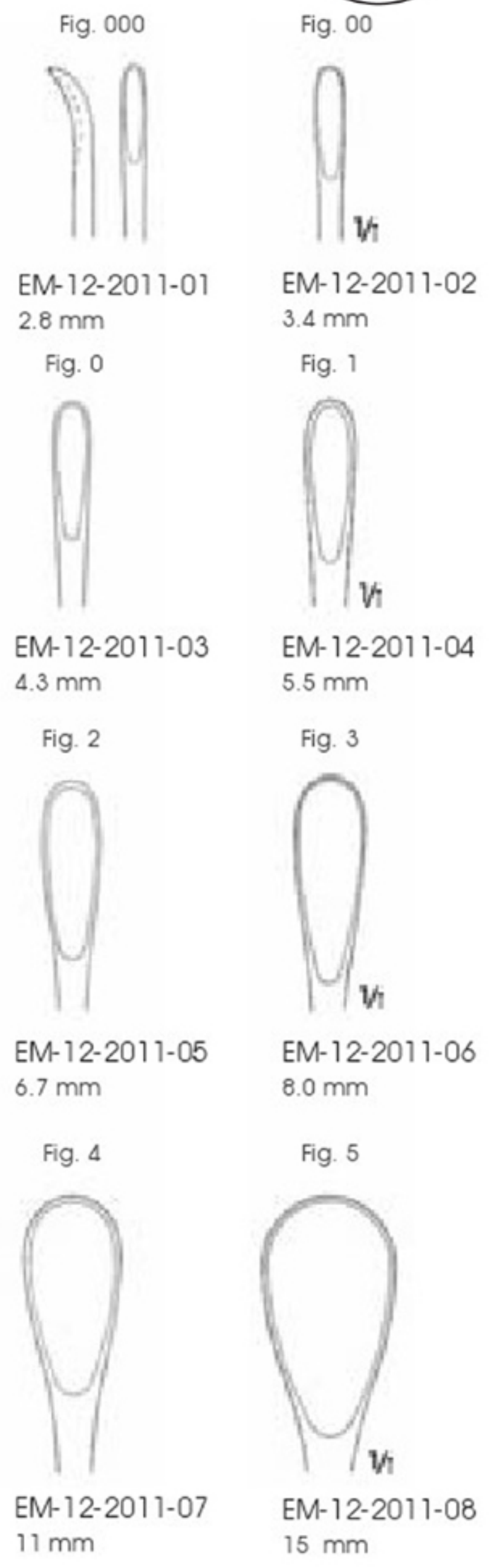
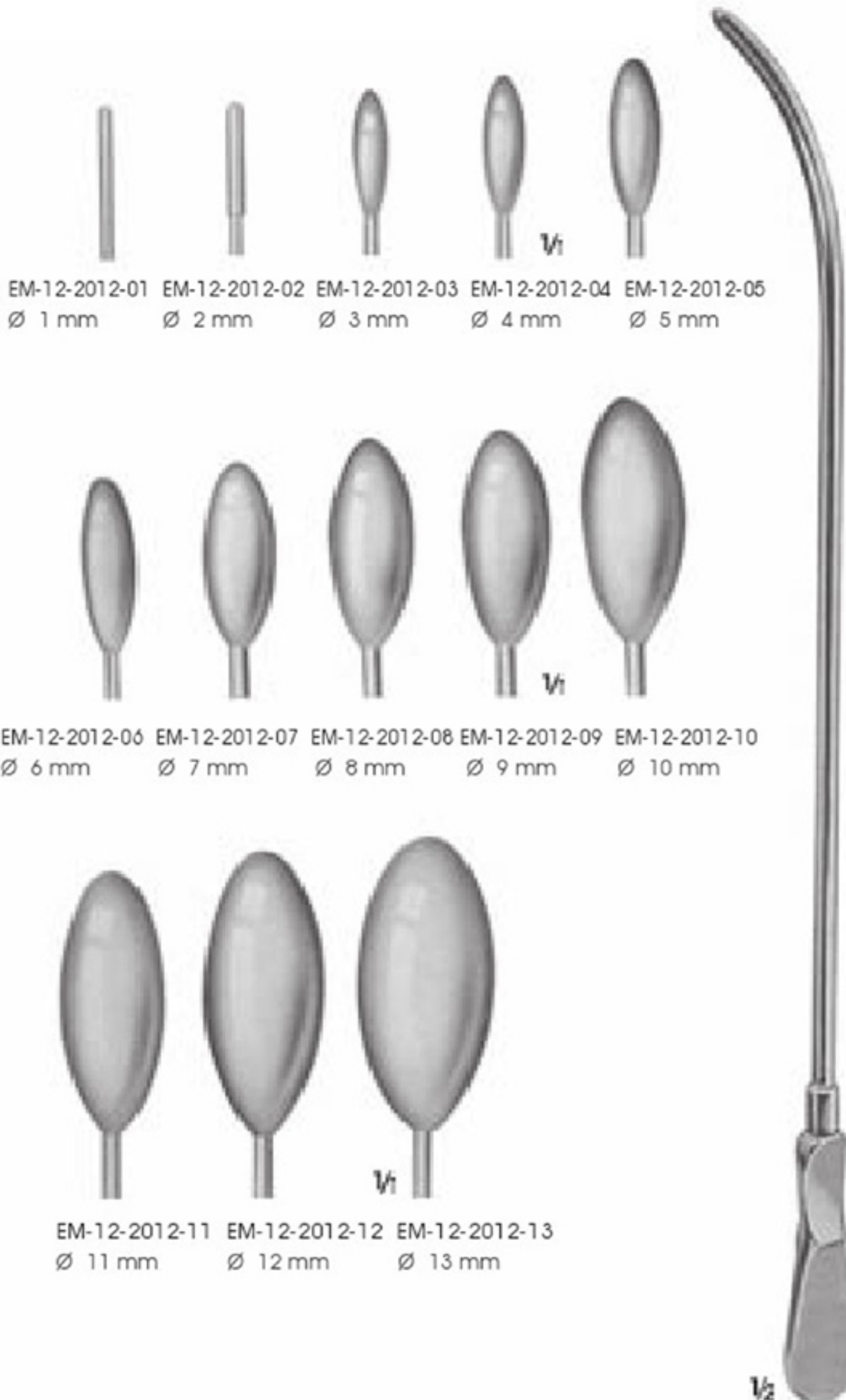

Fig. 000	Fig. 00
EM-12-2011-01 2.8 mm	EM-12-2011-02 3.4 mm
Fig. 0	Fig. 1
EM-12-2011-03 4.3 mm	EM-12-2011-04 5.5 mm
Fig. 2	Fig. 3
EM-12-2011-05 6.7 mm	EM-12-2011-06 8.0 mm
Fig. 4	Fig. 5
EM-12-2011-07 11 mm	EM-12-2011-08 15 mm



EM-12-2012-01 Ø 1 mm
EM-12-2012-02 Ø 2 mm
EM-12-2012-03 Ø 3 mm
EM-12-2012-04 Ø 4 mm
EM-12-2012-05 Ø 5 mm

EM-12-2012-06 Ø 6 mm
EM-12-2012-07 Ø 7 mm
EM-12-2012-08 Ø 8 mm
EM-12-2012-09 Ø 9 mm
EM-12-2012-10 Ø 10 mm

EM-12-2012-11 Ø 11 mm
EM-12-2012-12 Ø 12 mm
EM-12-2012-13 Ø 13 mm

	Charr. (French)
EM-12-2013-08	8
EM-12-2013-09	9
EM-12-2013-10	10
EM-12-2013-11	11
EM-12-2013-12	12
EM-12-2013-13	13
EM-12-2013-14	14
EM-12-2013-15	15
EM-12-2013-16	16
EM-12-2013-17	17
EM-12-2013-18	18
EM-12-2013-19	19
EM-12-2013-20	20
EM-12-2013-21	21
EM-12-2013-22	22
EM-12-2013-23	23
EM-12-2013-24	24
EM-12-2013-25	25
EM-12-2013-26	26
EM-12-2013-27	27
EM-12-2013-28	28
EM-12-2013-29	29
EM-12-2013-30	30

BAKES
EM-12-2012-01 - 2012-12
Common bile duct dilators, malleable
31 cm

DITTEL
EM-12-2013-08 - 2013-30
Metal bougies and dilating sounds
34.5 cm

EM-12-2014-08



EM-12-2014-07



EM-12-2014-06



EM-12-2014-05



EM-12-2014-04

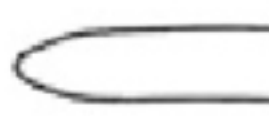

EM-12-2014-03

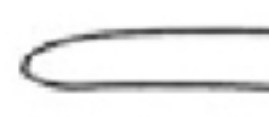

EM-12-2014-02



EM-12-2014-01

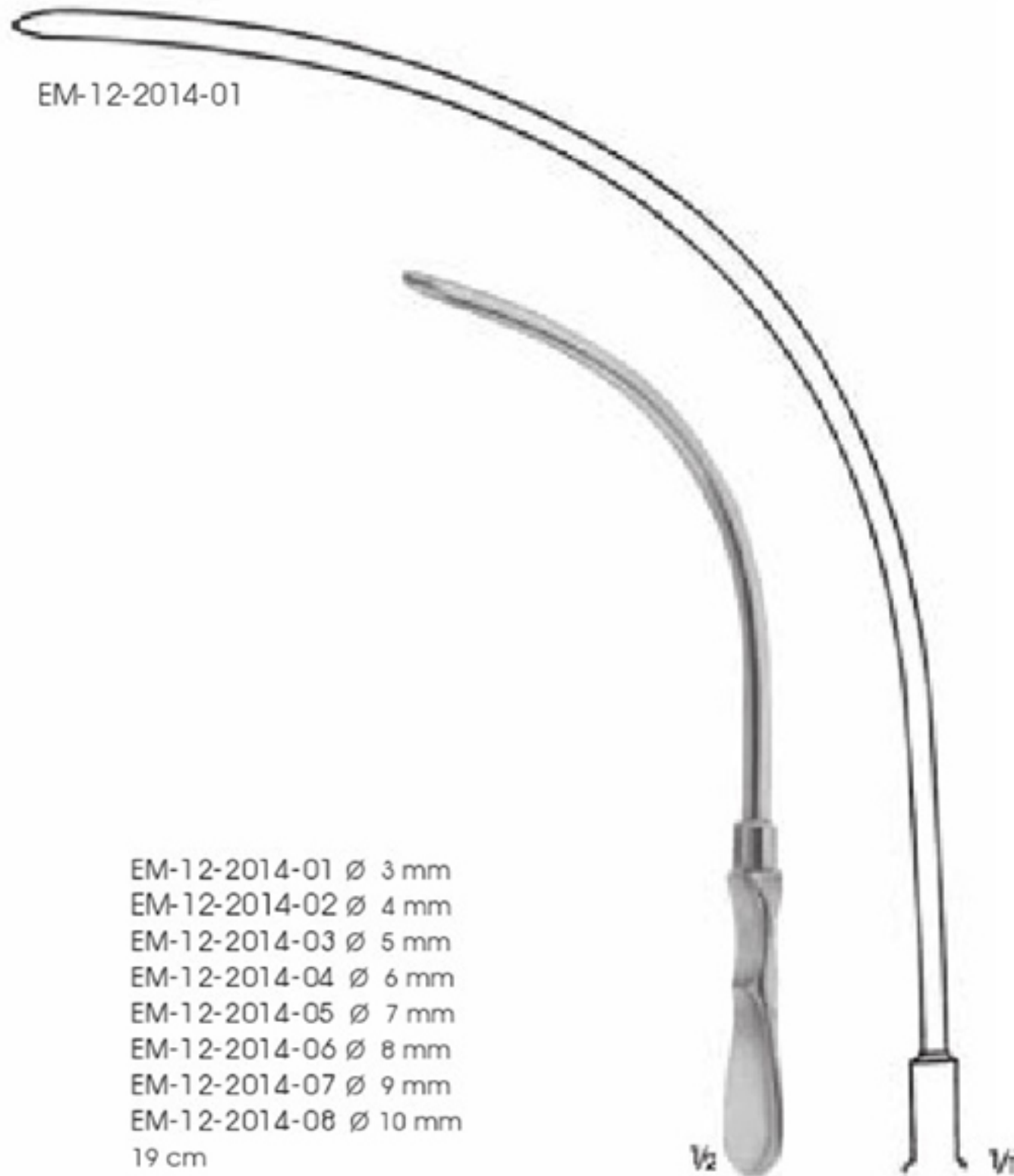

- EM-12-2014-01 Ø 3 mm
 - EM-12-2014-02 Ø 4 mm
 - EM-12-2014-03 Ø 5 mm
 - EM-12-2014-04 Ø 6 mm
 - EM-12-2014-05 Ø 7 mm
 - EM-12-2014-06 Ø 8 mm
 - EM-12-2014-07 Ø 9 mm
 - EM-12-2014-08 Ø 10 mm
- 19 cm

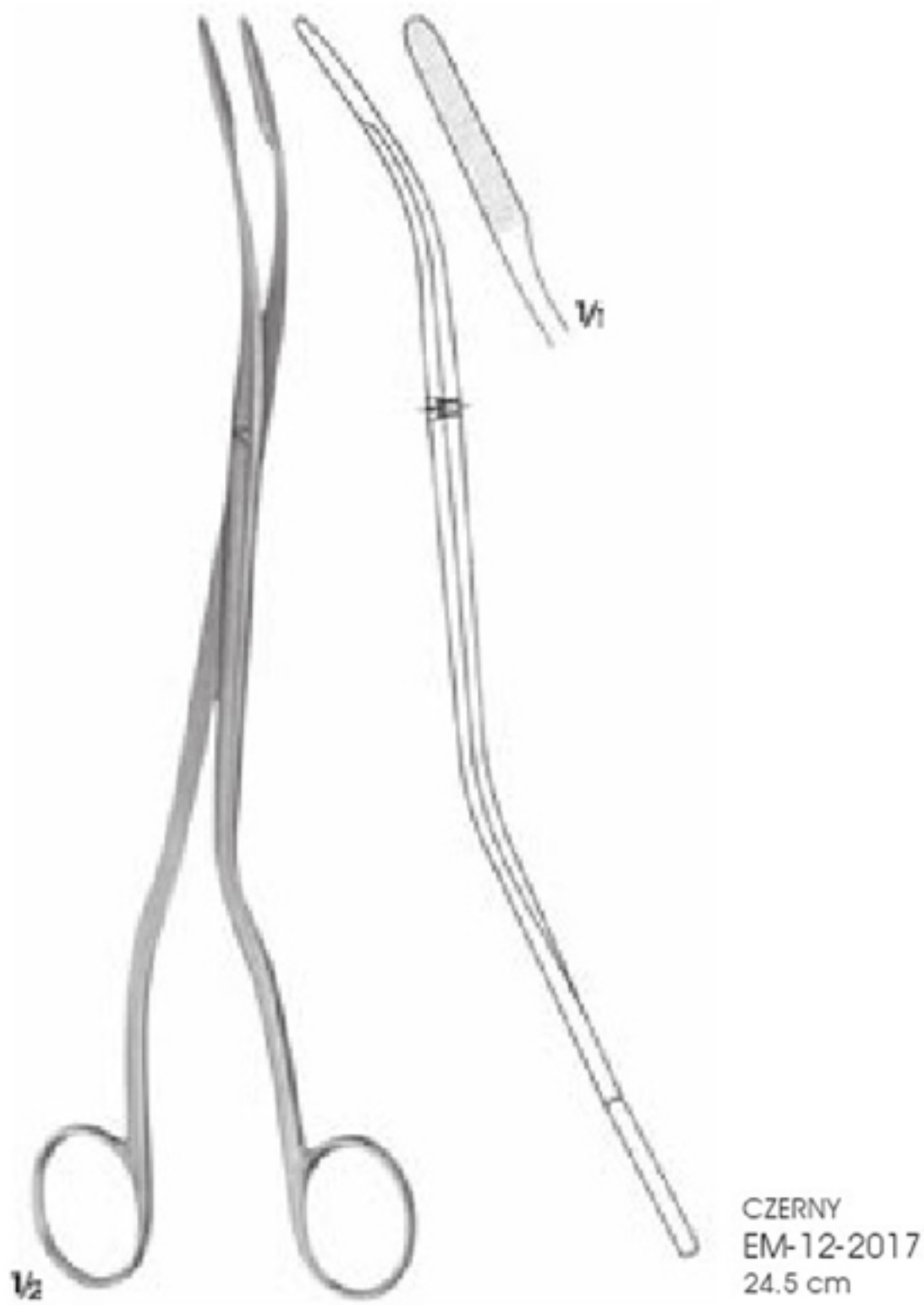



EM-12-2019-01 EM-12-2019-02



EM-12-2020-01
24 cm



EM-12-2019-03 EM-12-2019-04



EM-12-2020-02
22.5 cm

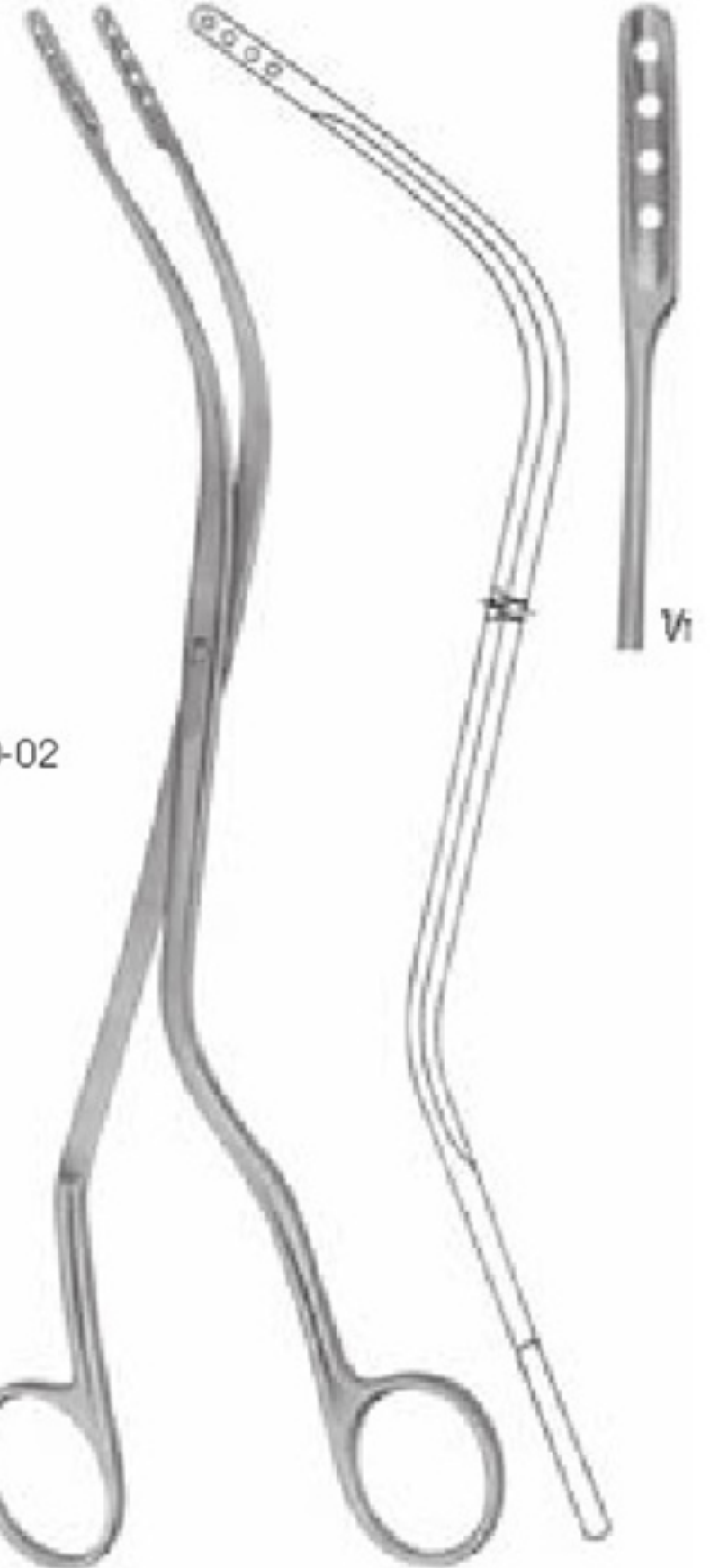

TÜBINGER
EM-12-2021
25.5 cm



DESJARDINS
EM-12-2019-01 - 2019-04
22.5 cm



DESJARDINS
EM-12-2020-01 - 2020-02
Hassas model
Extremely delicate patterns