



Gynaecology Instruments

Gynäkologische Instrumente



COLLIN
EM-14-2082
53 x 10 mm
For children



COLLIN
EM-14-2083
95/85 x 18 mm
For virgins

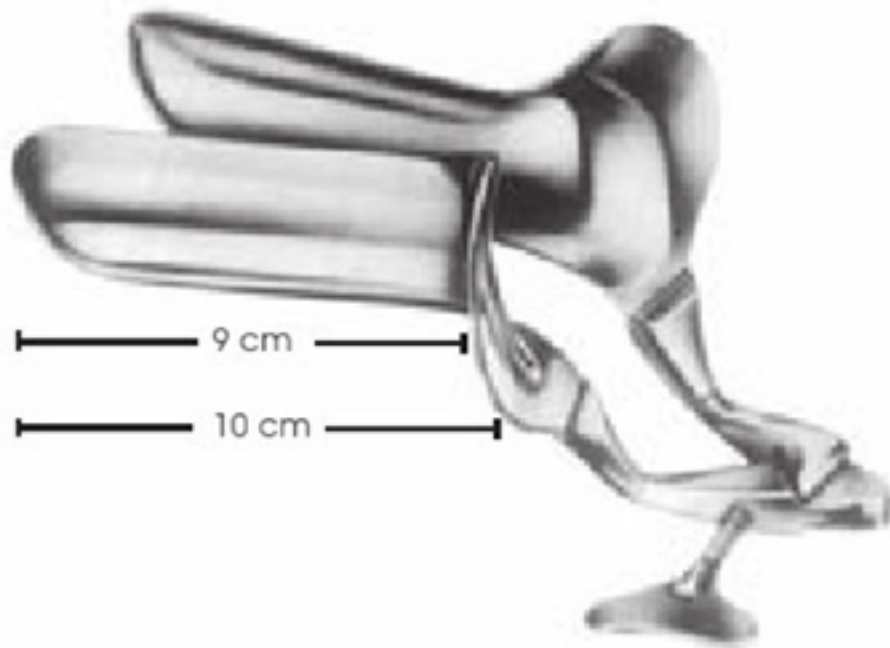

COLLIN	Çalışma boy Working length	En Width
EM-14-2084-01	100/90 mm	28 mm
EM-14-2084-02	100/90 mm	32 mm
EM-14-2084-03	105/95 mm	35 mm
EM-14-2084-04	115/105 mm	40 mm



TRELAT
EM-14-2085-01 85 x 33 mm
EM-14-2085-02 95 x 35 mm
EM-14-2085-03 115 x 43 mm



CUSCO
EM-14-2086
75 x 17 mm
For virgins



CUSCO
EM-14-2087
75 x 17 mm
For virgins



CUSCO STANDARD
EM-14-2088-01 80 x 24 mm
EM-14-2088-02 80 x 32 mm
EM-14-2088-03 90 x 36 mm
EM-14-2088-04 110 x 37 mm
Standard patterns

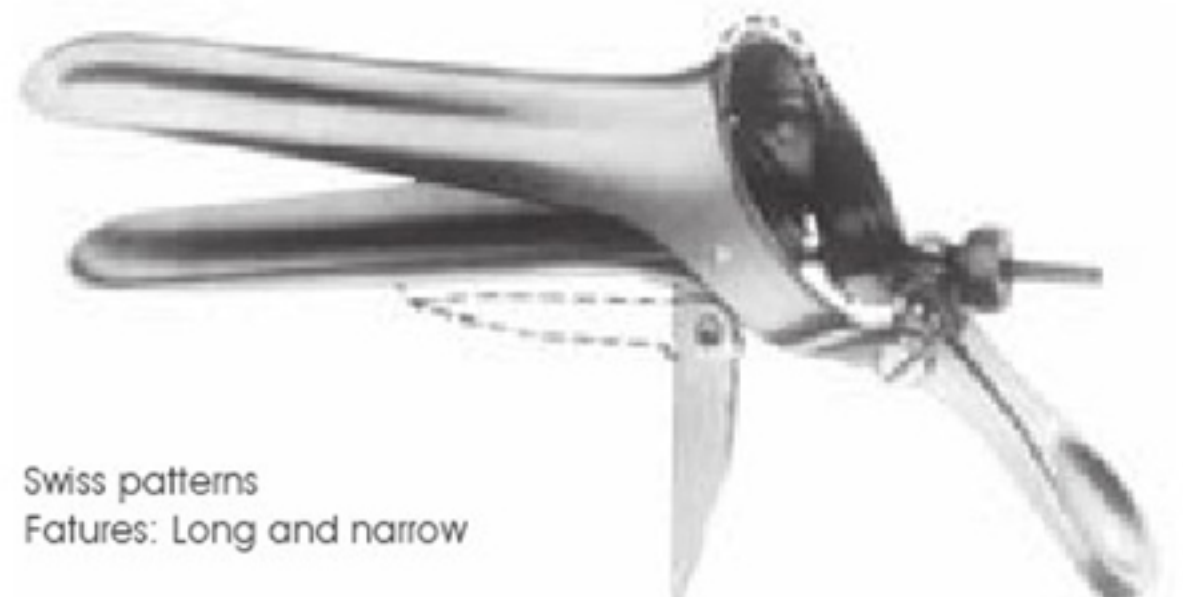

Swiss patterns
Features: Long and narrow

CUSCO
EM-14-2089-01 92 x 23 - 25 mm
EM-14-2089-02 100 x 25 - 27 mm
EM-14-2089-03 110 x 27 - 30 mm



CUSCO
EM-14-2090-01 80 x 32 mm
EM-14-2090-02 90 x 37 mm
EM-14-2090-04 115 x 37 mm
Flat (Duck beak)

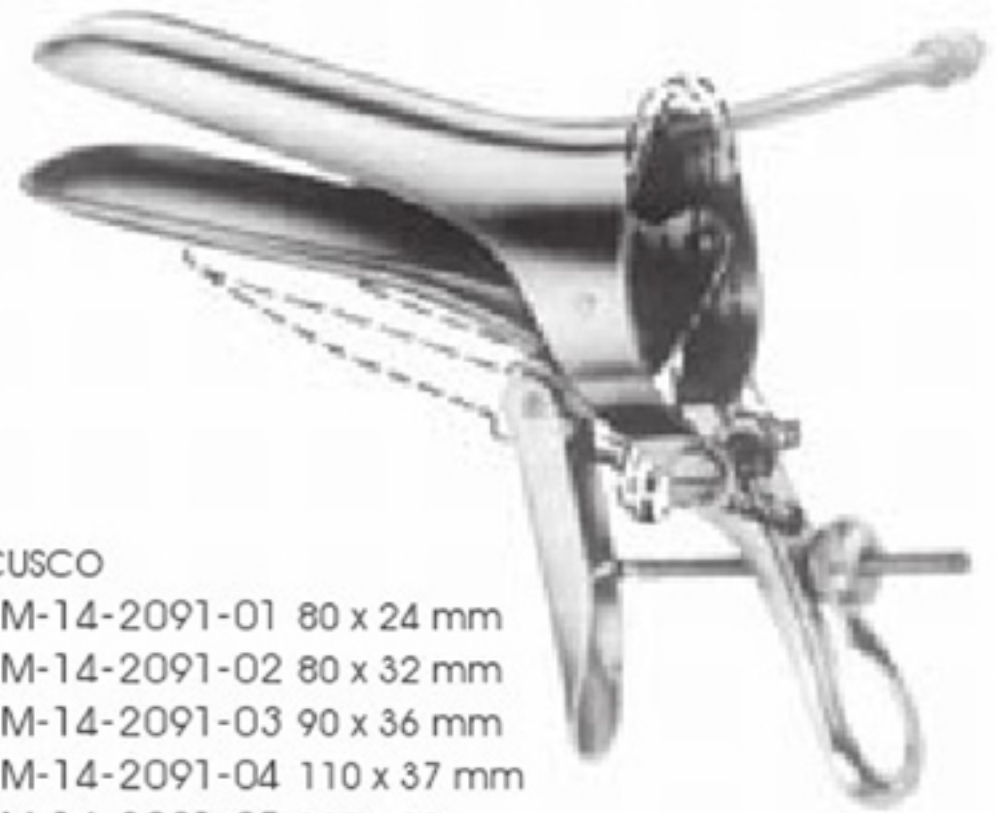

CUSCO
EM-14-2091-01 80 x 24 mm
EM-14-2091-02 80 x 32 mm
EM-14-2091-03 90 x 36 mm
EM-14-2091-04 110 x 37 mm
EM-14-2091-05 107 x 29 mm
EM-14-2091-06 115 x 35 mm
With suction tube



GRAVE
EM-14-2092-01 75 x 20 mm
EM-14-2092-02 95 x 30 mm
EM-14-2092-03 105 x 33 mm



PEDERSON
EM-14-2093-01 100 x 22 mm
EM-14-2093-02 120 x 25 mm

Parmak baskısıyla açılıp kapanan çift işaretili
With double ratchet, closing and opening of
ratchet by pressure of thumb

SEMM
EM-14-2094
90 x 14 - 18 mm
For children and virgins



Parmak baskısıyla açılıp kapanan çift işaretili
With double ratchet, closing and opening of
ratchet by pressure of thumb

SEMM
EM-14-2095-01 100 x 20 - 24 mm
EM-14-2095-02 100 x 30 - 34 mm
18.5 cm



SEYFFERT
EM-14-2096-01 100 x 17 mm
EM-14-2096-02 100 x 33 mm
23 cm

Alet ve katateterleri çıkarmak için bir tarafı açık
One side open for faking up instruments and
catheters



SEYFFERT
EM-14-2097-01 110 x 33 mm
23 cm



SEIDL
 EM-14-2098-01 80 x 8 mm
 EM-14-2098-02 80 x 10 mm
 EM-14-2098-03 90 x 14 mm
 For children and infants
 17 cm

1/2



KRISTELLER
 EM-14-2099 70 x 15 mm
 For children
 17 cm

1/2



KRISTELLER
 EM-14-2100-01 70 x 27 mm
 EM-14-2100-02 75 x 30 mm
 EM-14-2100-03 90 x 36 mm
 17.5 cm

1/2



KRISTELLER
 EM-14-2101-01 110 x 18 mm
 EM-14-2101-02 110 x 20 mm
 EM-14-2101-03 110 x 27 mm
 EM-14-2101-04 110 x 30 mm
 EM-14-2101-05 110 x 36 mm
 22 cm

1/2



KRISTELLER
 EM-14-2102-01 - 2102-04
 Upper blades

EM-14-2102-01
 75 x 10 mm
 17.5 cm



EM-14-2102-02
 75 x 23 mm
 18 cm



EM-14-2102-03
 80 x 25 mm
 18 cm



EM-14-2102-04
 100 x 32 mm
 18.5 cm



KRISTELLER
 EM-14-2103-01 - 2103-04
 Lower blade

EM-14-2103-01
 70 x 15 mm
 17.5 cm



EM-14-2103-02
 70 x 27 mm
 18 cm



EM-14-2103-03
 75 x 30 mm
 18 cm



EM-14-2103-04
 90 x 36 mm
 18.5 cm





KRISTELLER
 EM-14-2102-05 - 2102-09
 Upper blades

EM-14-2102-05
 115 x 14 mm
 21.5 cm



EM-14-2102-06
 115 x 23 mm
 21.5 cm



EM-14-2102-07
 115 x 16 mm
 22 cm



EM-14-2102-08
 115 x 26 mm
 22 cm



EM-14-2102-09
 120 x 30 mm
 22.5 cm



1/2



KRISTELLER
 EM-14-2103-06 - 2103-09
 Lower blades

EM-14-2103-05
 110 x 18 mm
 21.5 cm



EM-14-2103-06
 110 x 27 mm
 21.5 cm



EM-14-2103-07
 110 x 20 mm
 22 cm



EM-14-2103-08
 110 x 30 mm
 22 cm



EM-14-2103-09
 110 x 36 mm
 22.5 cm



1/2



KRISTELLER
EM-14-2104-01 - 2104-03
Upper blades
20.5 cm

EM-14-2104-01
80 x 28 mm



EM-14-2104-02
85 x 35 mm



EM-14-2104-03
85 x 40 mm



JACKSON
EM-14-2105-01 - 2105-03
Lower blades

EM-14-2105-01
76 x 38 mm



EM-14-2105-02
89 x 38 mm



EM-14-2105-03
110 x 38 mm





KALLMORGEN
EM-14-2106 Set
75 x 39 mm
17 cm



KALLMORGEN
EM-14-2107 Set
95 x 39 mm
20 cm

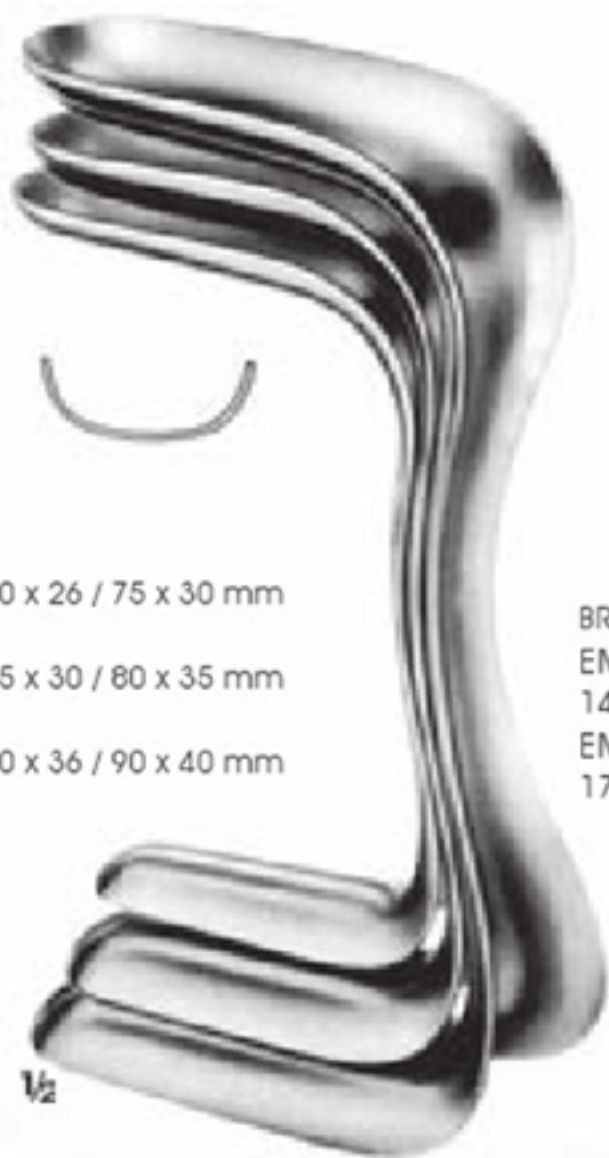

SIMS
EM-14-2108-01 70 x 26 / 75 x 30 mm
12.5 cm
EM-14-2108-02 75 x 30 / 80 x 35 mm
15 cm
EM-14-2108-03 80 x 36 / 90 x 40 mm
17.5 cm



BREISKY
EM-14-2109-01 72 x 25 / 77 x 30 mm
14 cm
EM-14-2109-02 75 x 30 / 92 x 38 mm
17 cm

EM-14-2110-01
110 x 20 mm



EM-14-2110-04
115 x 18 mm



EM-14-2110-03
110 x 30 mm



EM-14-2110-05
115 x 26 mm



EM-14-2110-03
110 x 36 mm



EM-14-2110-06
115 x 32 mm



EM-14-2110-01 - 2110-06
A lower blade
21.5 cm



KRISTELLER
EM-14-2110-07 110 x 20 mm
EM-14-2110-08 110 x 30 mm
EM-14-2110-09 110 x 36 mm
Vienna patterns sets

1/2



KRISTELLER
EM-14-2110-04 - 2110-06
Upper blade
22 cm

1/2



1/2
 BRAUN
 EM-14-2111
 56 x 13 mm
 18 cm



1/2
 BRAUN
 EM-14-2112
 60 x 10 mm
 18 cm



1/2
 HEANEY
 EM-14-2113
 89 x 29 mm
 17 cm



1/2
 EASTMAN
 EM-14-2114
 89 x 38 mm
 17.5 cm



1/2
 LANDON
 EM-14-2115
 89 x 25 mm
 19.5 cm



1/2
 MATHIEU
 EM-14-2116
 inner blade
 95 x 17 - 30 mm
 21 cm



1/2
 MATHIEU
 EM-14-2117
 Upper blade
 95 x 17 - 26 mm
 inner blade K 843.01)
 21 cm

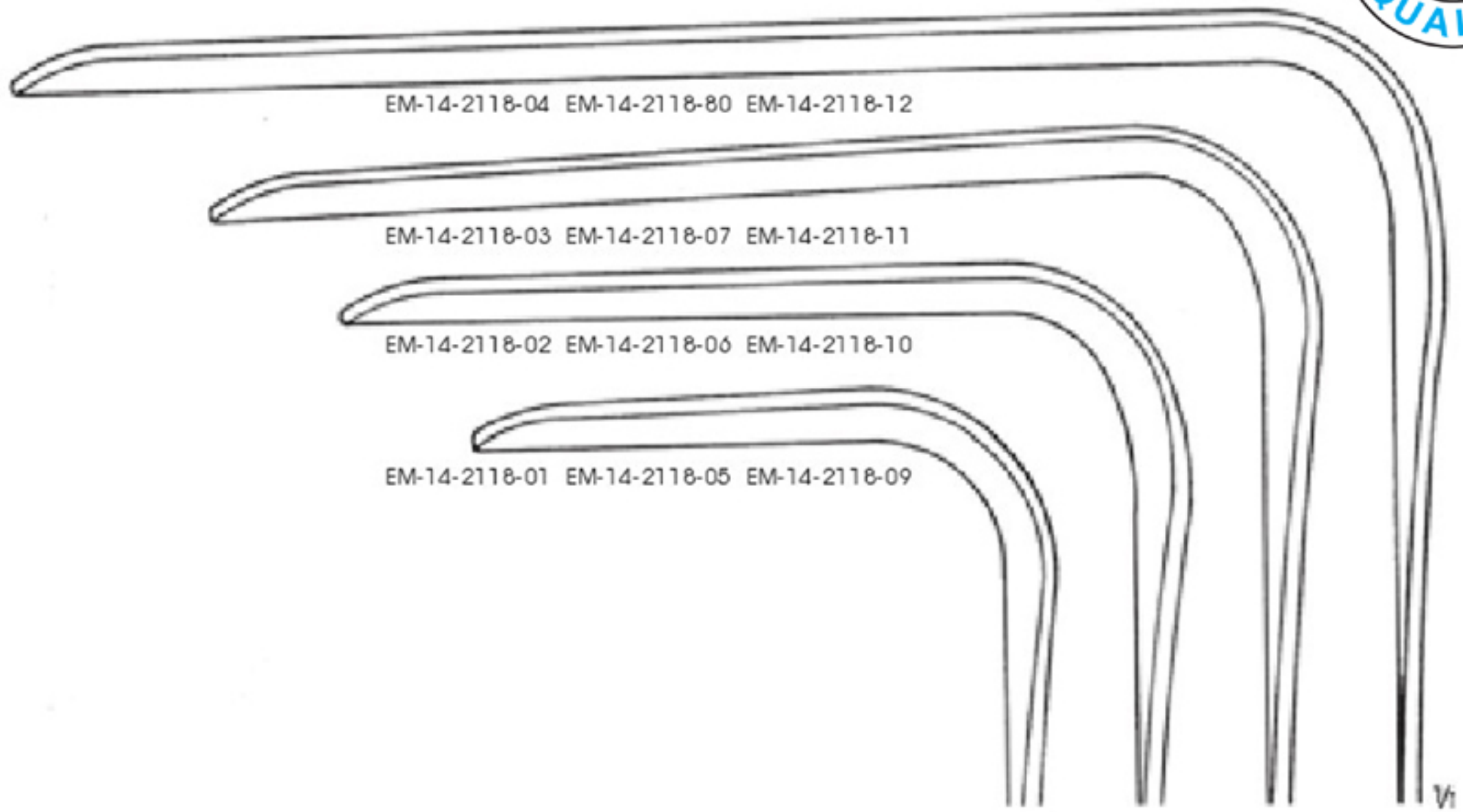

1/2

Length of blades	Width of blades		
	35 mm	45 mm	60 mm
60 mm	EM-14-2118-01	EM-14-2118-05	EM-14-2118-09
90 mm	EM-14-2118-02	EM-14-2118-06	EM-14-2118-10
120 mm	EM-14-2118-03	EM-14-2118-07	EM-14-2118-11
160 mm	EM-14-2118-04	EM-14-2118-80	EM-14-2118-12

DOYEN
EM-14-2118-01 - 2118-12
24 cm



LANDAU
EM-14-2119-01 100 x 28 mm
EM-14-2119-02 110 x 38 mm
29 cm

1/2



BREISKY
EM-14-2120-01 100 x 20 mm
EM-14-2120-02 100 x 25 mm
EM-14-2120-03 100 x 30 mm
EM-14-2120-04 100 x 35 mm
EM-14-2120-05 100 x 40 mm
Vienna patterns
30 cm

1/2



BREISKY
EM-14-2121-01 130 x 20 mm
EM-14-2121-02 130 x 25 mm
EM-14-2121-03 130 x 30 mm
EM-14-2121-04 130 x 35 mm
EM-14-2121-05 130 x 40 mm
Vienna patterns
32 cm

1/2



BREISKY
EM-14-2122-01 160 x 40 mm
EM-14-2122-02 180 x 40 mm
Vienna patterns
35 cm

1/2





1/2

DOYEN
 EM-14-2127-01 - 2127-03
 23.5 cm



EM-14-2127-03
 112 x 45 mm



EM-14-2127-02
 90 x 45 mm



EM-14-2127-01
 60 x 45 mm

1/2



60 x 30 mm

1/2

DOYEN
 EM-14-2128
 Lateral speculum
 23 cm



80 x 30 mm

1/2

DOYEN
 EM-14-2129
 Lateral speculum
 25 cm



WEISSBARTH
EM-14-2130-01 80 x 28 mm
EM-14-2130-02 85 x 42 mm
21 cm

EM-14-2130-03
Removable strainer only

1/2



AUVARD
EM-14-2131
65 x 38-28 mm
1.530 gr.
With detachable weight
23 cm

1/2



AUVARD
EM-14-2132-01 75 x 42-40 mm
EM-14-2132-02 105 x 43-40 mm
1.470 gr.
With detachable weight
23 cm

1/2



AUVARD
EM-14-2133
65 x 38-28 mm
1.530 gr.
Fixed weight
23 cm

1/2



EM-14-2134-04
80 x 30 mm

EM-14-2134-05
85 x 35 mm

EM-14-2134-06
85 x 40 mm



EM-14-2134-07
55 x 40-60 mm

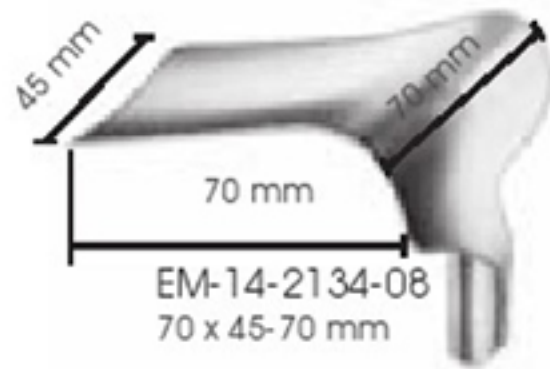

EM-14-2134-08
70 x 45-70 mm



EM-14-2134-01
Handle

EM-14-2135

The mentioned blades (EM-14-2134-04 - 2134-08 and EM-14-2134-09 - 2134-16) can be exchanged. They fit handle EM-14-2134-01 as well as handles EM-14-2134-02 and EM-14-2134-03

SCHERBACK
EM-14-2135 Complete
(EM-14-2134-01) Handle
(EM-14-2133) Weight
(EM-14-2134-04 EM-14-2134-07) 4 Blades

1/2

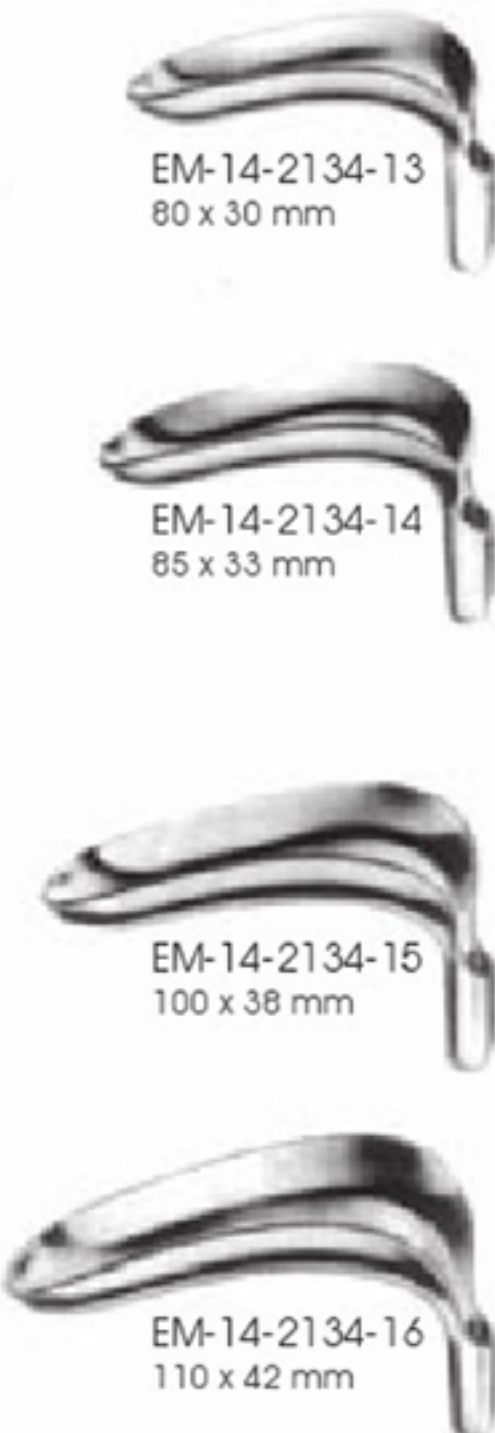

EM-14-2134-13
80 x 30 mm

EM-14-2134-14
85 x 33 mm

EM-14-2134-15
100 x 38 mm

EM-14-2134-16
110 x 42 mm



EM-14-2134-09
65 x 30 mm

EM-14-2134-10
75 x 35 mm

EM-14-2134-11
85 x 35 mm

EM-14-2134-12
95 x 35 mm

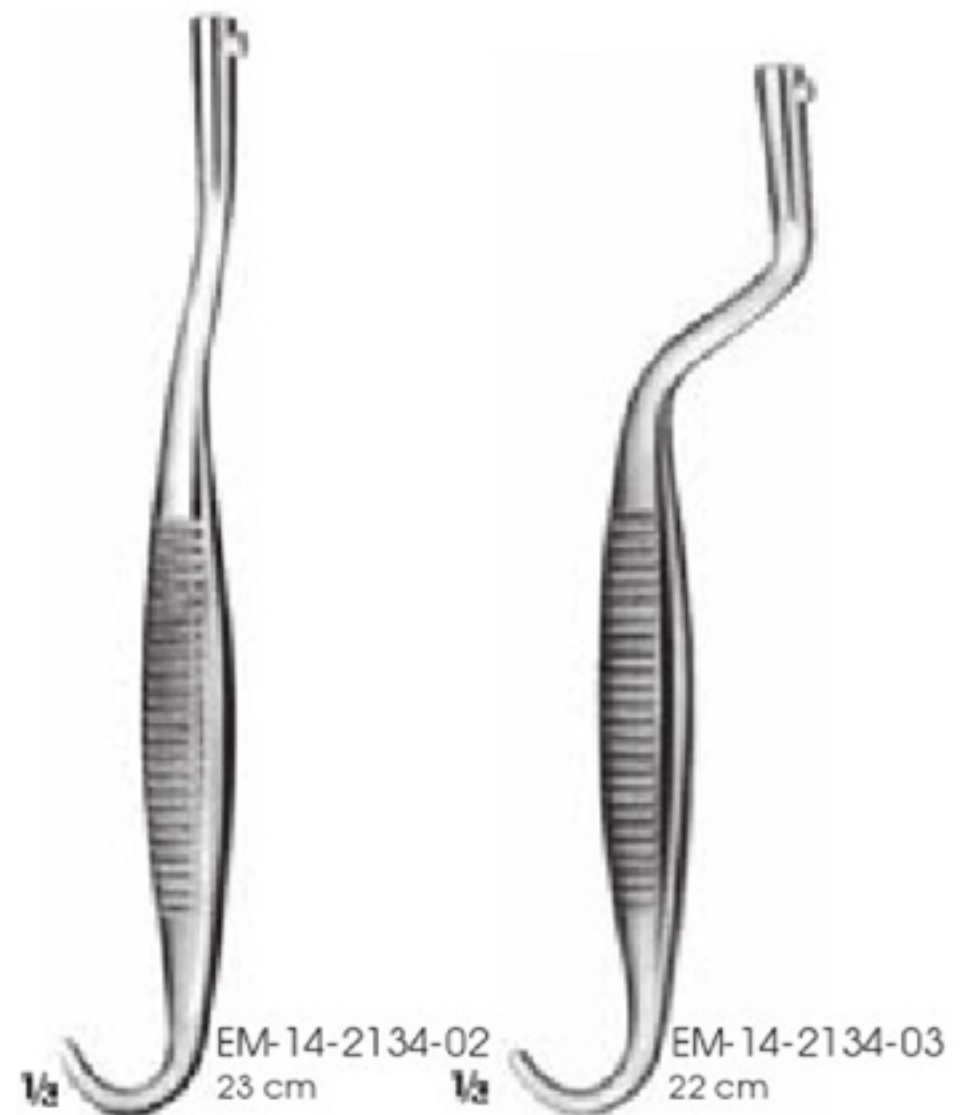

EM-14-2134-02
23 cm

EM-14-2134-03
22 cm

BOZEMANN
EM-14-2134-17 Set
(EM-14-2134-02 - 2134-03) 2 Handles
(EM-14-2134-09 - 2134-16) 8 Blades



GELPI
EM-14-2136
13.5 cm



GELPI
EM-14-2137
17.5 cm



RICHTER
EM-14-2138
17 cm



JOLL (FRIEDMANN)
EM-14-2139
15.5 cm



HEGAR
EM-14-2140-01 - 2141-17
With very conical point
18.5 cm

EM-14-2140-01	1 mm	EM-14-2140-14	14 mm	EM-14-2141-01	1.5 mm	EM-14-2141-14	14.5 mm
EM-14-2140-02	2 mm	EM-14-2140-15	15 mm	EM-14-2141-02	2.5 mm	EM-14-2141-15	15.5 mm
EM-14-2140-03	3 mm	EM-14-2140-16	16 mm	EM-14-2141-03	3.5 mm	EM-14-2141-16	16.5 mm
EM-14-2140-04	4 mm	EM-14-2140-17	17 mm	EM-14-2141-04	4.5 mm	EM-14-2141-17	17.5 mm
EM-14-2140-05	5 mm	EM-14-2140-18	18 mm	EM-14-2141-05	5.5 mm		
EM-14-2140-06	6 mm	EM-14-2140-19	19 mm	EM-14-2141-06	6.5 mm		
EM-14-2140-07	7 mm	EM-14-2140-20	20 mm	EM-14-2141-07	7.5 mm		
EM-14-2140-08	8 mm	EM-14-2140-21	21 mm	EM-14-2141-08	8.5 mm		
EM-14-2140-09	9 mm	EM-14-2140-22	22 mm	EM-14-2141-09	9.5 mm		
EM-14-2140-10	10 mm	EM-14-2140-23	23 mm	EM-14-2141-10	10.5 mm		
EM-14-2140-11	11 mm	EM-14-2140-24	24 mm	EM-14-2141-11	11.5 mm		
EM-14-2140-12	12 mm	EM-14-2140-25	25 mm	EM-14-2141-12	12.5 mm		
EM-14-2140-13	13 mm	EM-14-2140-26	26 mm	EM-14-2141-13	13.5 mm		



HEGAR
EM-14-2142-01 - 2142-09
19.5 cm

EM-14-2142-01	1 + 2 mm
EM-14-2142-02	3 + 4 mm
EM-14-2142-03	5 + 6 mm
EM-14-2142-04	7 + 8 mm
EM-14-2142-05	9 + 10 mm
EM-14-2142-06	11 + 12 mm
EM-14-2142-07	13 + 14 mm
EM-14-2142-08	15 + 16 mm
EM-14-2142-09	17 + 18 mm



PRATT
EM-14-2143-01 - 2143-08
29 cm

EM-14-2143-01	13 - 15 Charr.
EM-14-2143-02	17 - 19 Charr.
EM-14-2143-03	21 - 23 Charr.
EM-14-2143-04	25 - 27 Charr.
EM-14-2143-05	29 - 31 Charr.
EM-14-2143-06	33 - 35 Charr.
EM-14-2143-07	37 - 39 Charr.
EM-14-2143-08	41 - 43 Charr.

EM-14-2144-01

Set (EM-14-2140-04 - 2140-17) 14 piece
With EM-14-2149-01 1 each, EM-14-2151-01 1 each,
EM-14-2148 15 each, EM-14-2146-01 1 each,
EM-14-2146-01 2 each.



EM-14-2144-02

Set (EM-14-2141-04 - 2141-17) 14 piece
With EM-14-2149-01 1 each, EM-14-2151-01 1 each, EM-14-2148 15
each, EM-14-2146-01 1 each, EM-14-2146-01 2 each.

EM-14-2145

Full set 28 piece
Set (EM-14-2140-04 - 2140-17)+(EM-14-2141-04 - 2141-17)
With EM-14-2149-01 1 each, EM-14-2152-02 1 each, EM-14-2151-01
1 each, EM-14-2148 15 each, EM-14-2146-01 1 each, EM-14-2147-01
2 each.



EM-14-2146-01 230 mm
EM-14-2146-02 470 mm
Sliding rails with securing
screws, for divider EM-14-2148



EM-14-2147-01 230 mm
EM-14-2147-02 470 mm
Limiting bars with securing
screws, particularly useful for
storing dilators

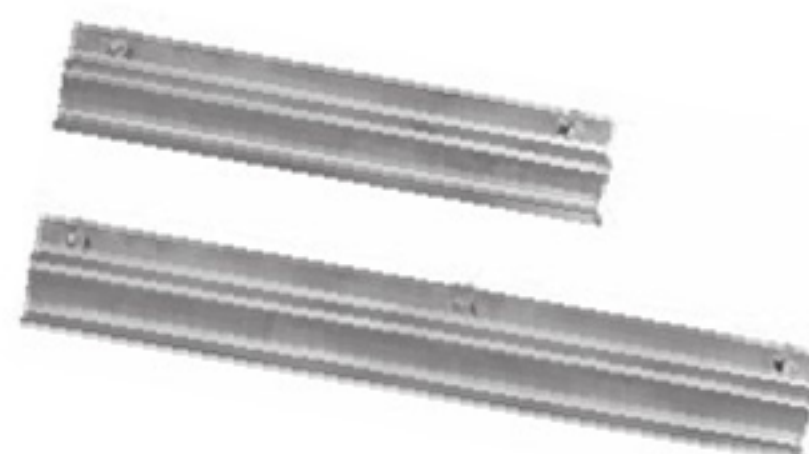

EM-14-2148

Divider, to be used with EM-14-2146-01



Container



EM-14-2149-01 285 x 280 x 100 mm
EM-14-2149-02 285 x 280 x 135 mm
EM-14-2149-03 285 x 280 x 150 mm
EM-14-2149-04 285 x 280 x 200 mm
EM-14-2149-05 285 x 280 x 260 mm

Container



EM-14-2150-01 580 x 280 x 100 mm
EM-14-2150-02 580 x 280 x 135 mm
EM-14-2150-03 580 x 280 x 150 mm
EM-14-2150-04 580 x 280 x 200 mm
EM-14-2150-05 580 x 280 x 260 mm

Wire baskets



EM-14-2151-01 242 x 252 x 40 mm
EM-14-2151-02 242 x 252 x 60 mm
EM-14-2151-03 242 x 252 x 80 mm
EM-14-2151-04 242 x 252 x 110 mm

Wire baskets



EM-14-2152-01 539 x 252 x 40 mm
EM-14-2152-02 539 x 252 x 60 mm
EM-14-2152-03 539 x 252 x 80 mm
EM-14-2152-04 539 x 252 x 110 mm

Tel taban/Wire Base



EM-14-2153 258 x 258 x 30 mm

Tel taban/Wire Base



EM-14-2154 545 x 255 x 30 mm



KOGAN
EM-14-2155
Without ratchet
24 cm

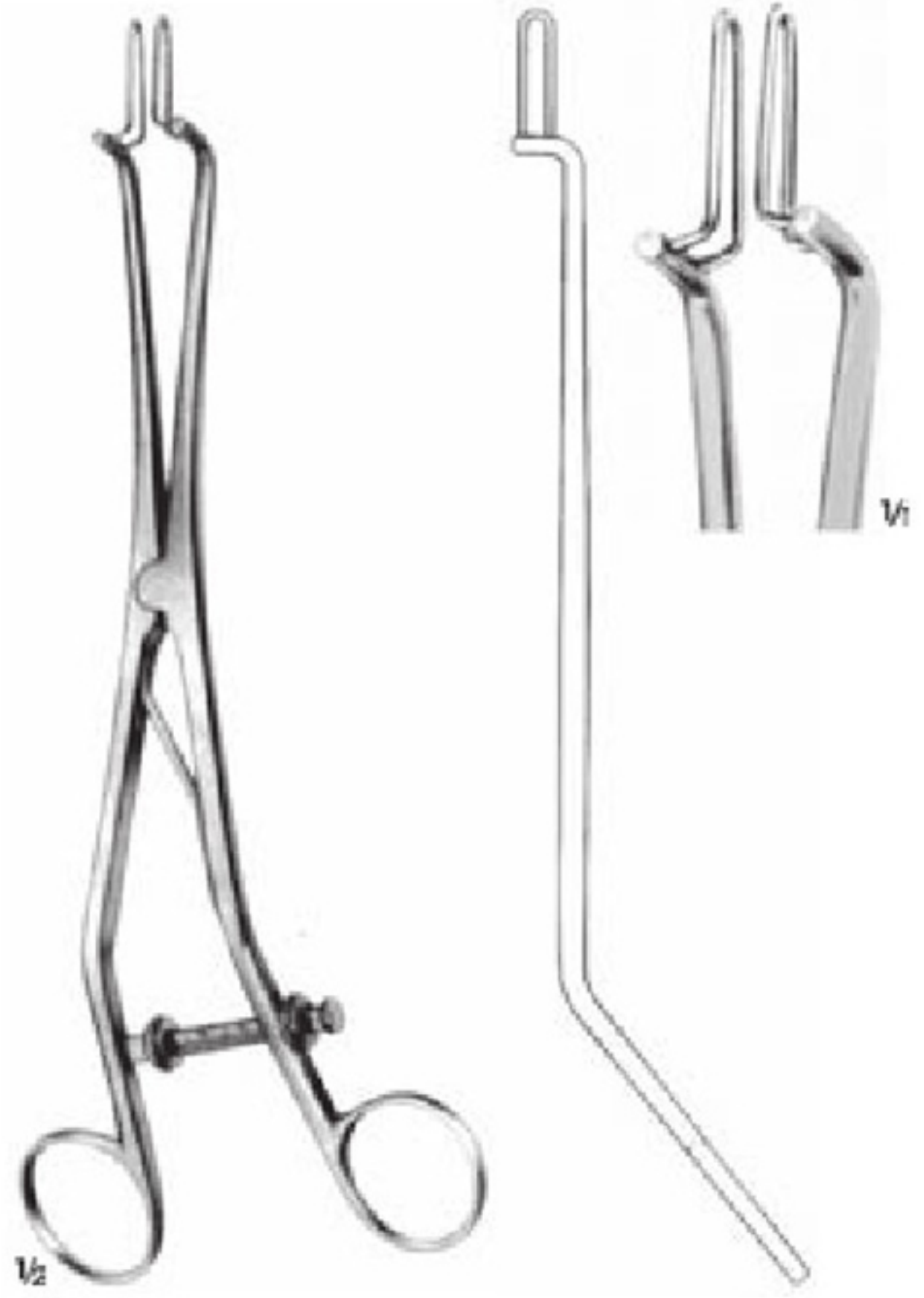

KOGAN
EM-14-2156
With scale-ratchet and fixing screw
24 cm

Ø 5 mm



1/2

MAYO
EM-14-2157
Malleable
33 cm

Ø 4 mm



1/2

SIMS
EM-14-2158-01 33 cm
EM-14-2158-02 33 cm
Malleable

Ø 3 mm



1/2

EM-14-2159
30 cm

Ø 4 mm



1/2

SIMPSON
EM-14-2160
Malleable, silver-plated
31 cm

Ø 3.6 mm



1/2

GALABINS
EM-14-2161
Shaft graduated in cm, malleable
29.5 cm

Ø 4 mm



1/2

VALLEIX
EM-14-2162
Graduated, with slider
25 cm

24 mm



28 mm

1/2

BRAUN
EM-14-2163
Uterine depressor
27 cm

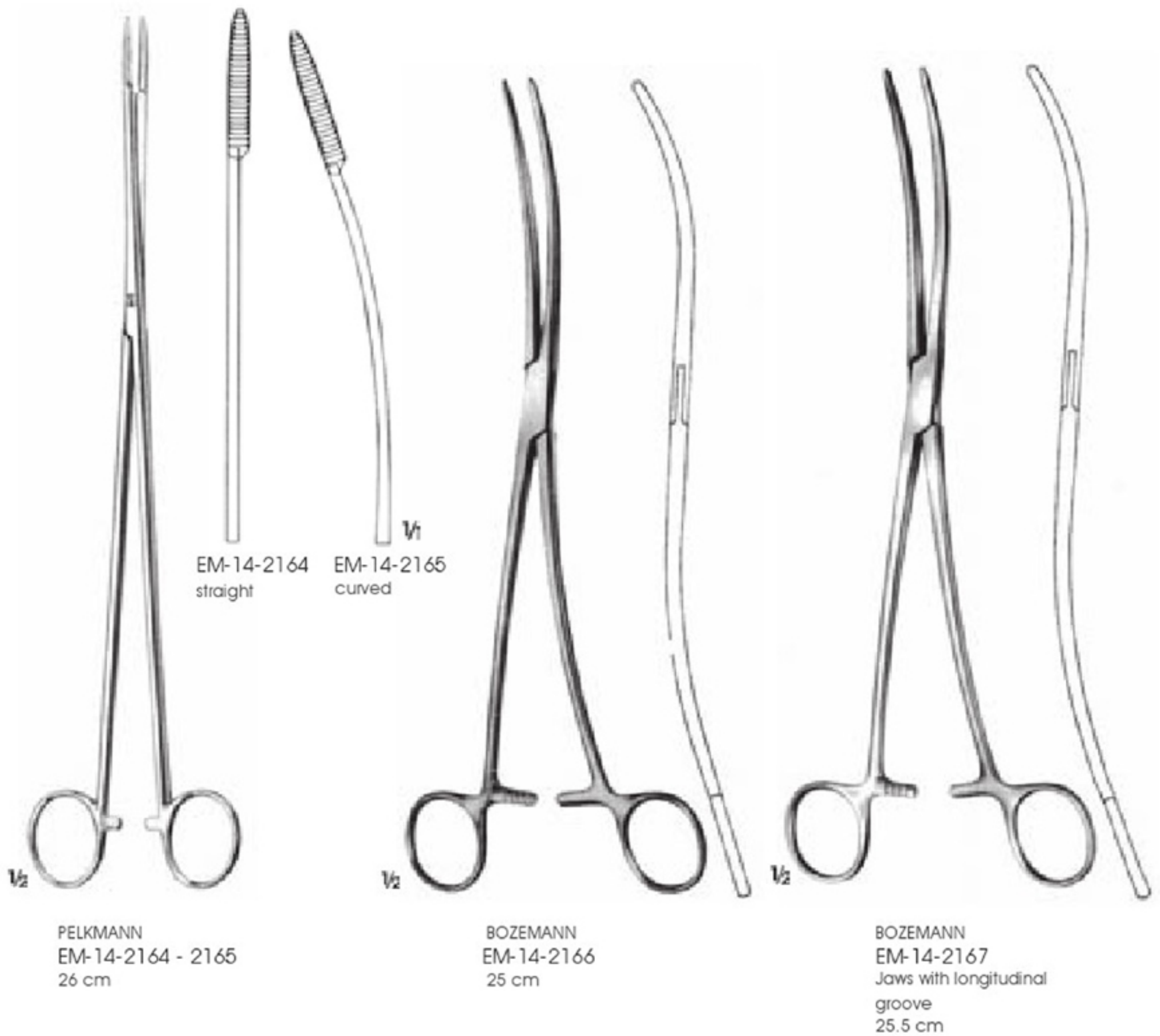



BOZEMANN
EM-14-2168 - 2169



EM-14-2168
26 cm



EM-14-2169
25 cm



BOZEMANN-DOUGLAS
EM-14-2170
26 cm

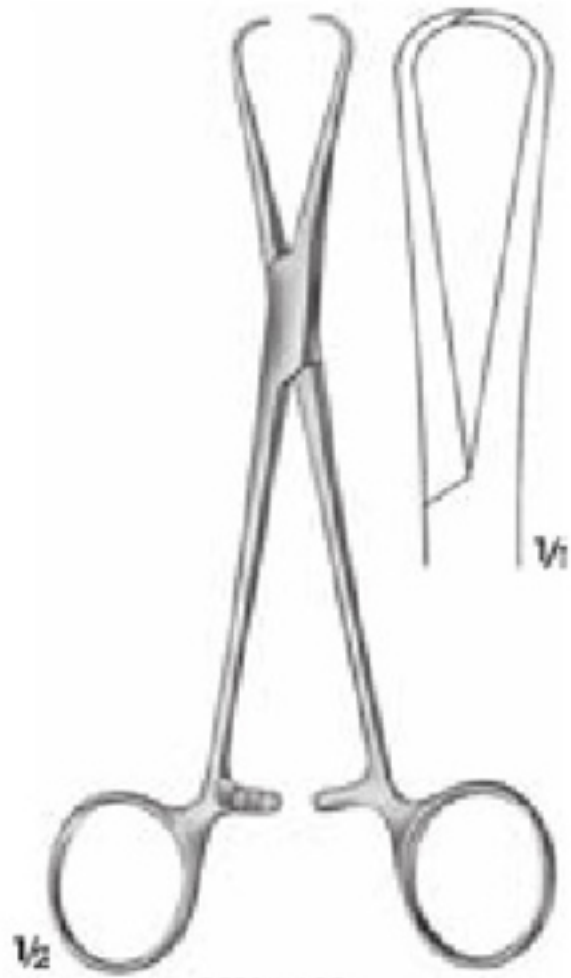

BERNHARD
 EM-14-2171
 16 cm



POZZI
 EM-14-2172
 17.5 cm



ADAIR
 EM-14-2173
 19 cm



BRAUN
 EM-14-2174
 Nain Model/Slender pattern
 25 cm



COLLIN-POZZI
 EM-14-2175
 25 cm



WILSON
 EM-14-2176
 24 cm



1/1



1/1



1/1



1/2

SCHRÖDER
EM-14-2177
Standart pattern
25 cm



1/2

SCHRÖDER
EM-14-2178
25 cm



1/2

POZZI
EM-14-2179
Heavy pattern
25.5 cm

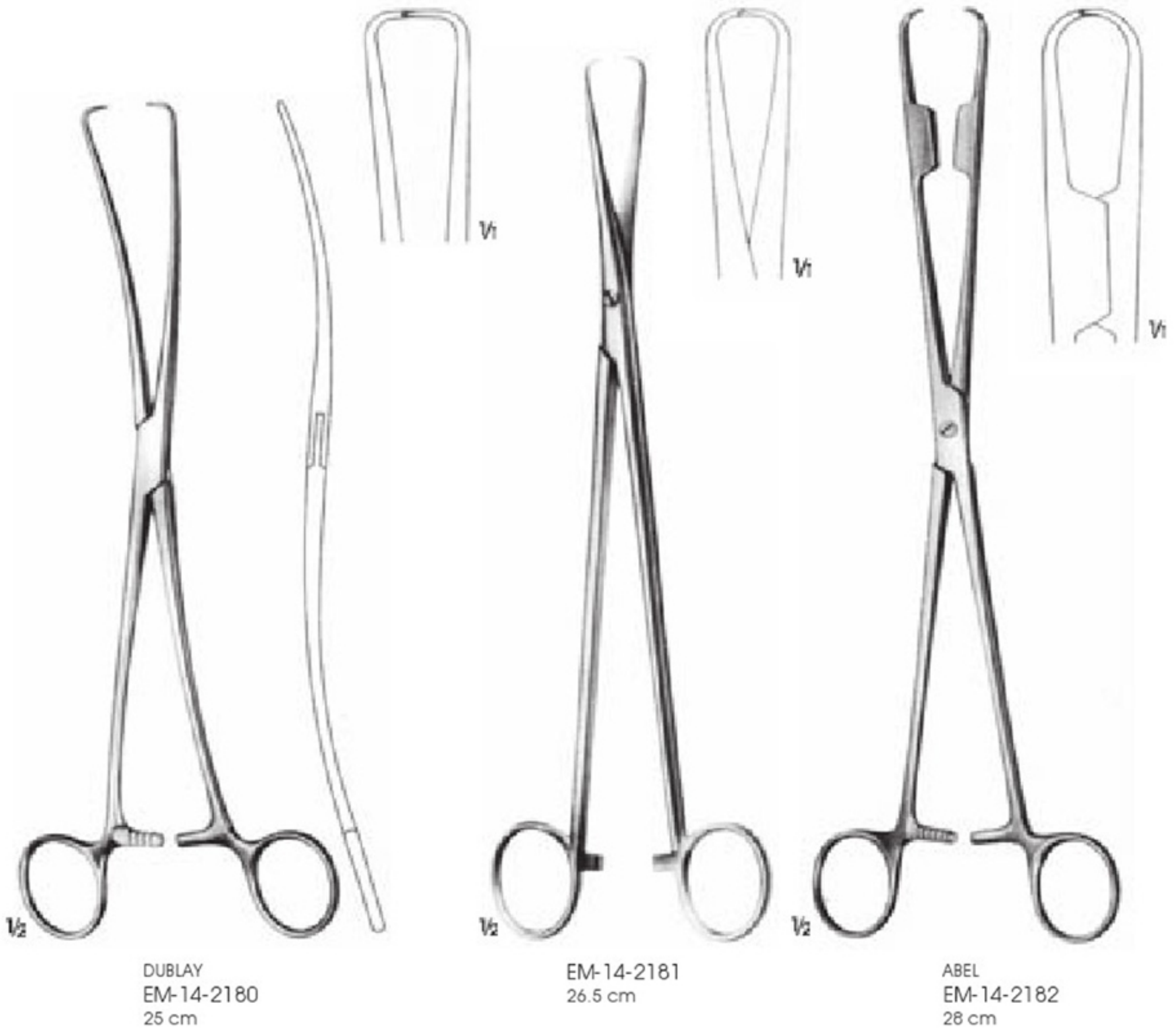



MUSEUX
 EM-14-2183
 20 cm



JACOBS
 EM-14-2184
 21.5 cm

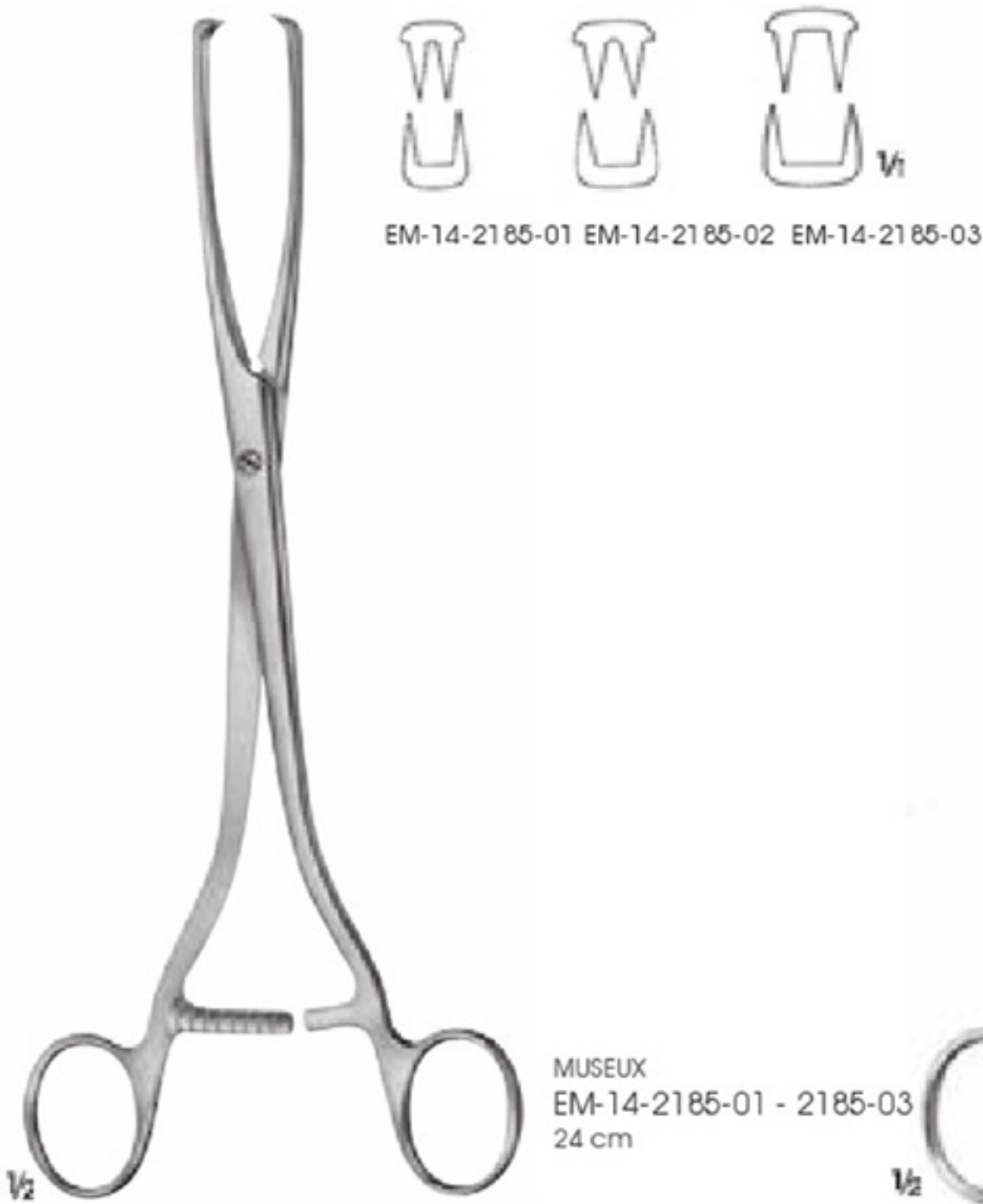

MUSEUX
 EM-14-2185-01 - 2185-03
 24 cm



MUSEUX
 EM-14-2186-01 - 2186-02
 26.5 cm



W
 W
 V1

LITTLEWOOD
 EM-14-2187
 18.5 cm



W
 W
 V1

TEALE
 EM-14-2188
 22.5 cm



EM-14-2199-01 EM-14-2199-02

MUSEUX
 EM-14-2199-01 - 2199-02
 Curved to side
 24 cm



W
 W
 V1

KÜSTNER
 EM-14-2200
 25 cm

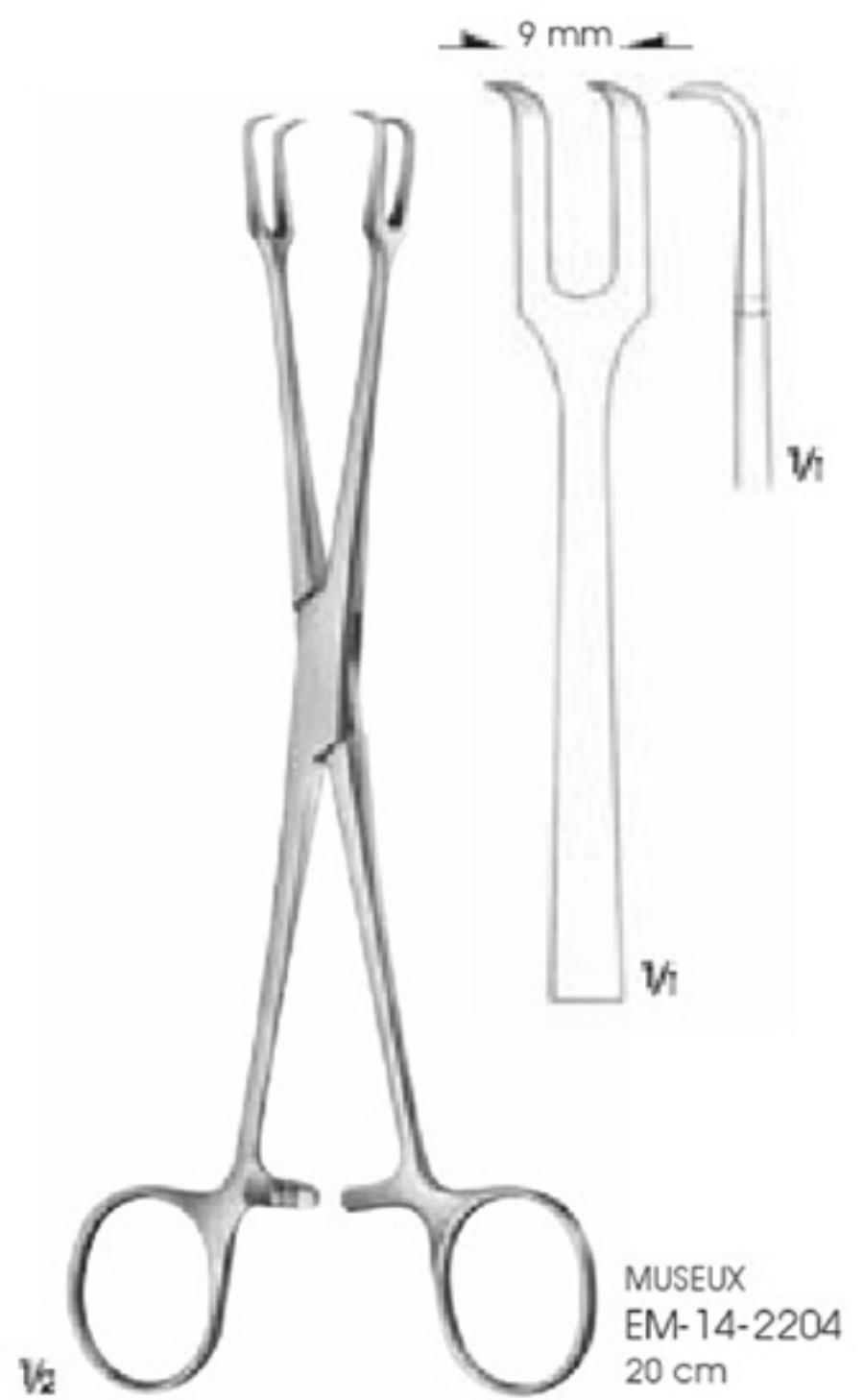
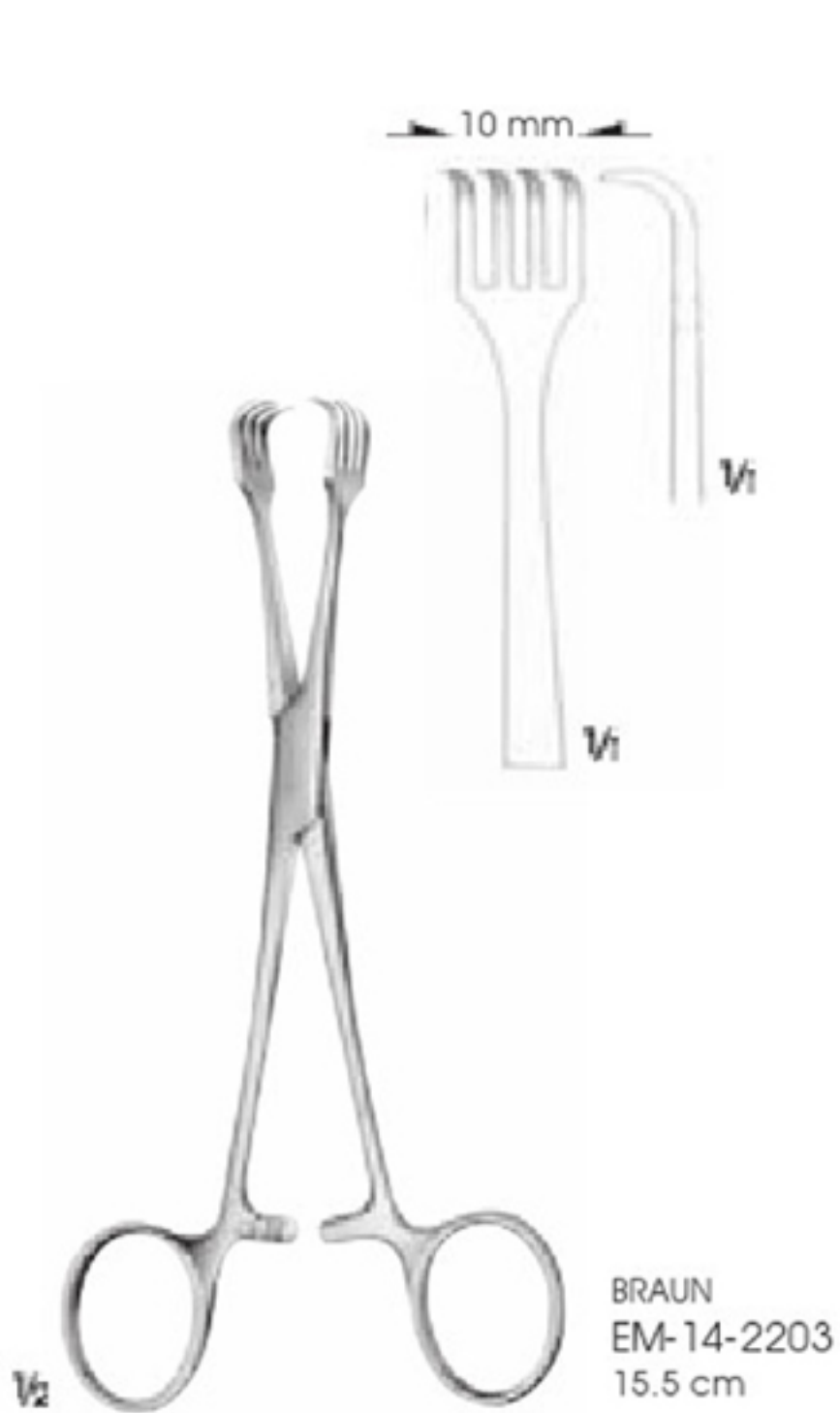
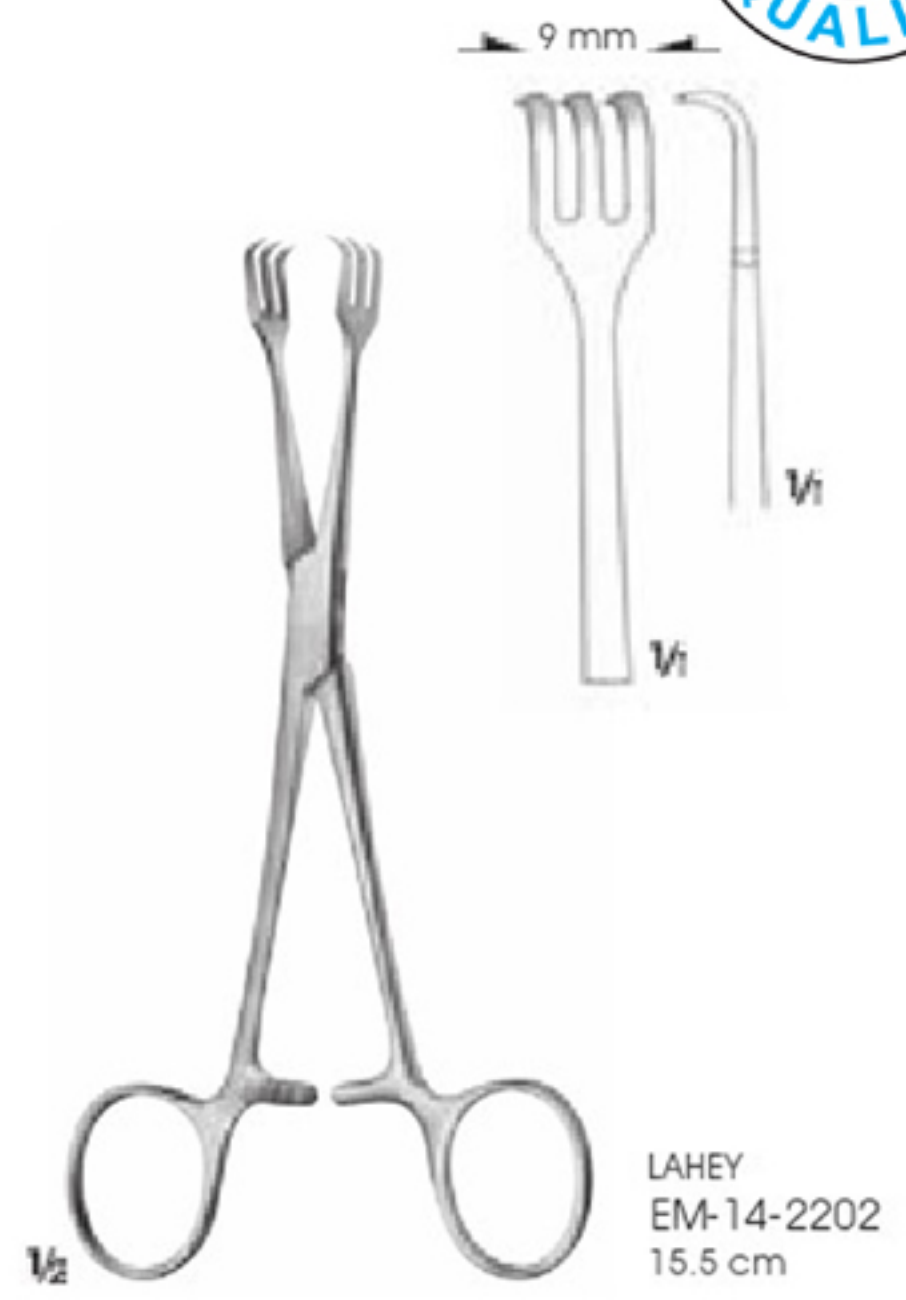
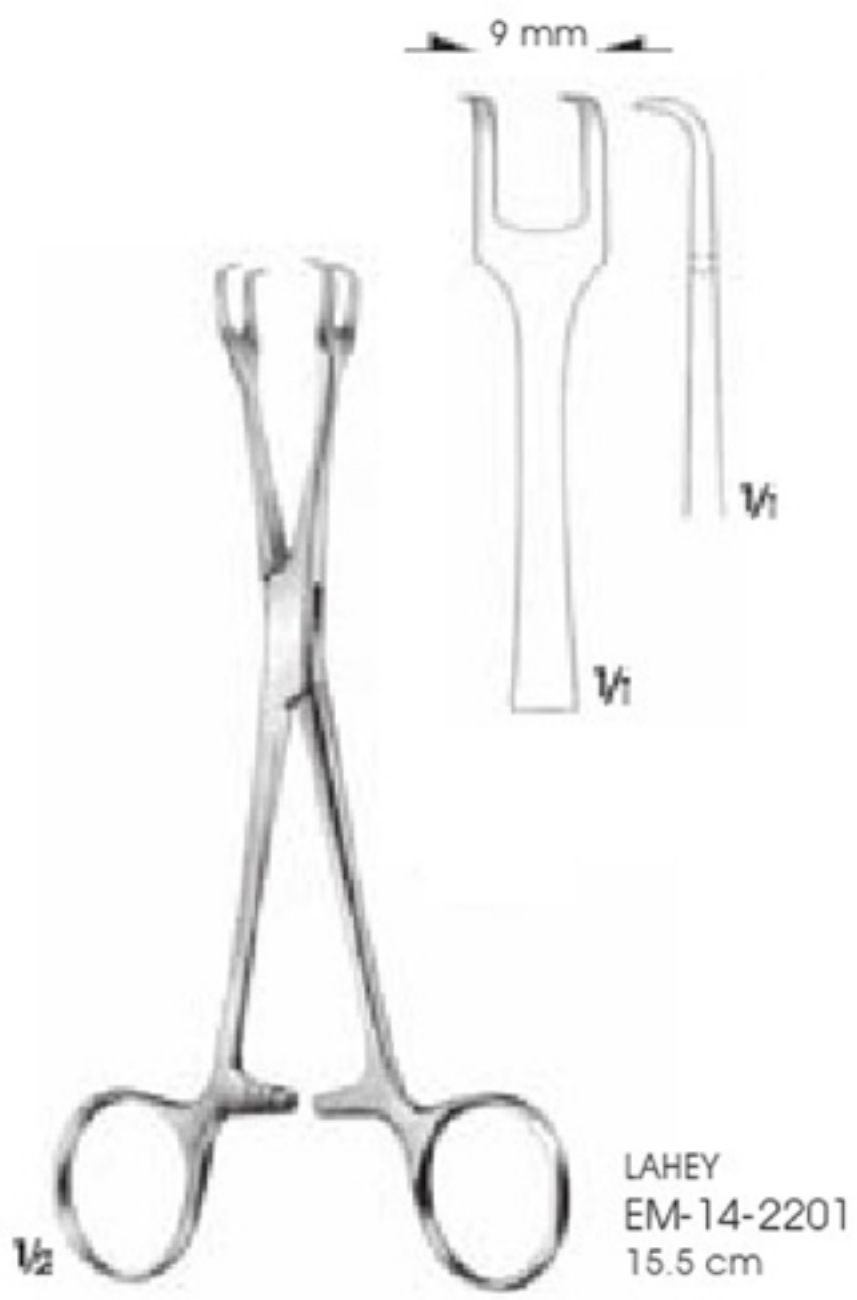

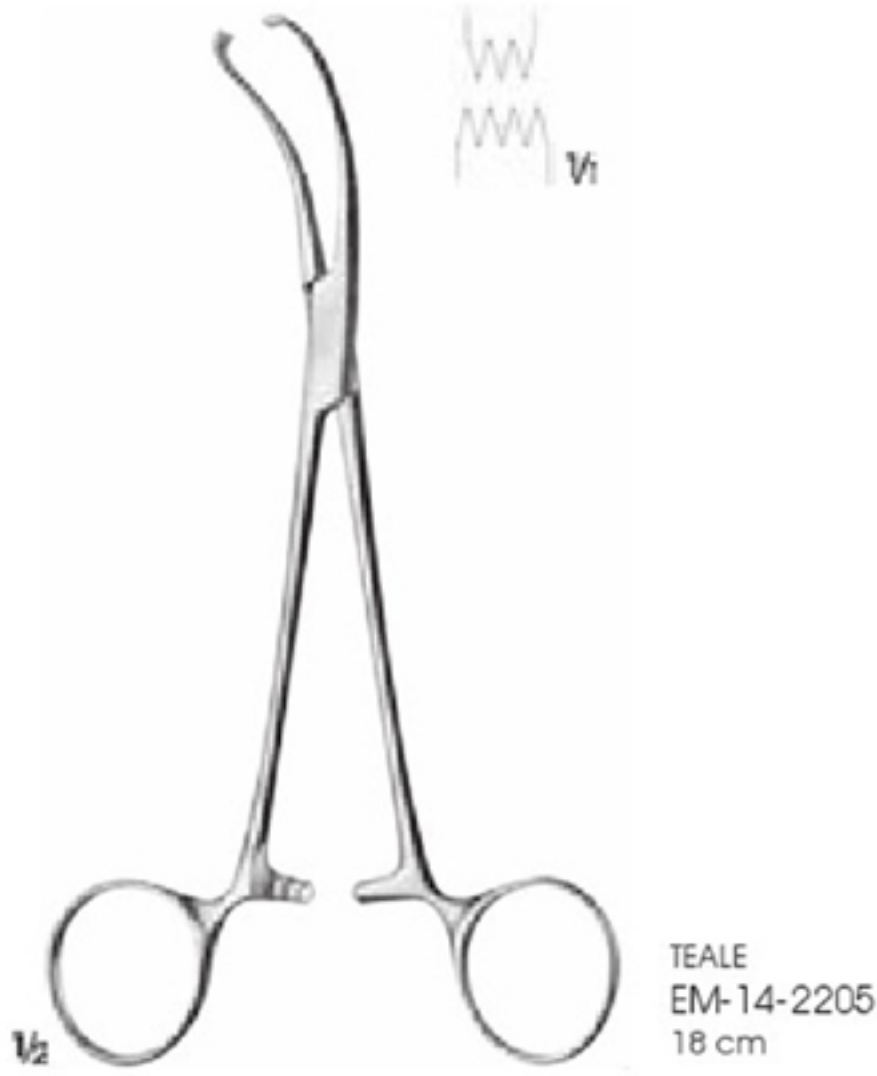

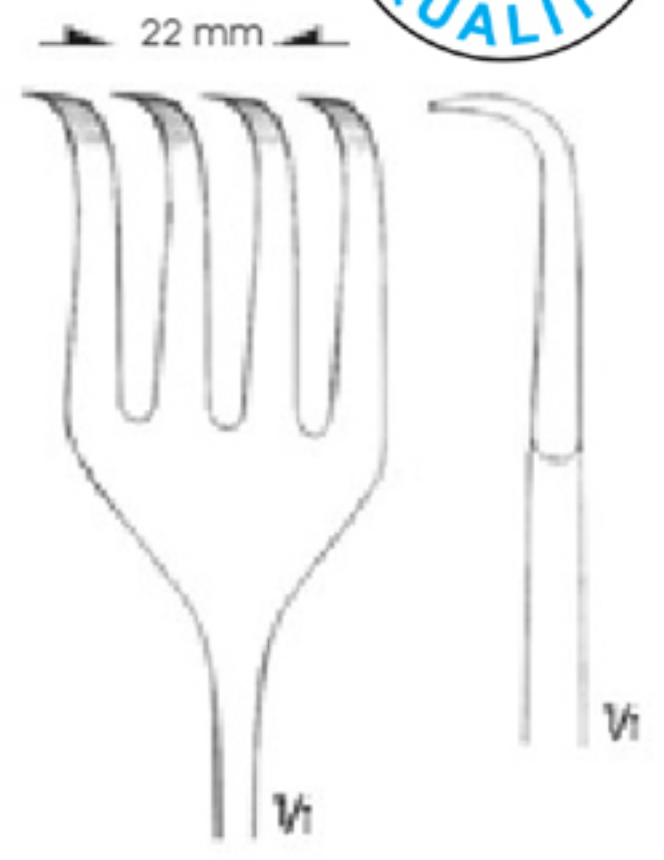
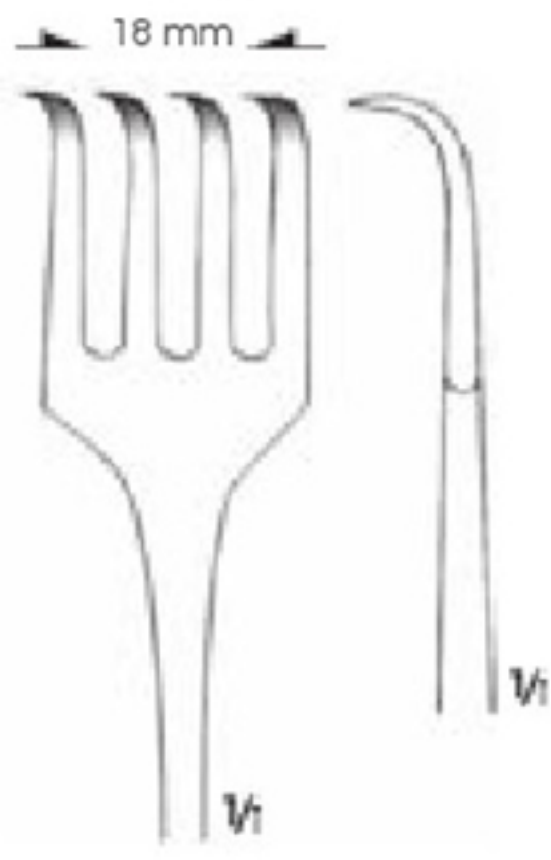

SCHRÖDER
EM-14-2210
27 cm



PRATT
EM-14-2211
26 cm



PRATT
EM-14-2212
27 cm



HEYWOOD-SMITH
EM-14-2213
25 cm

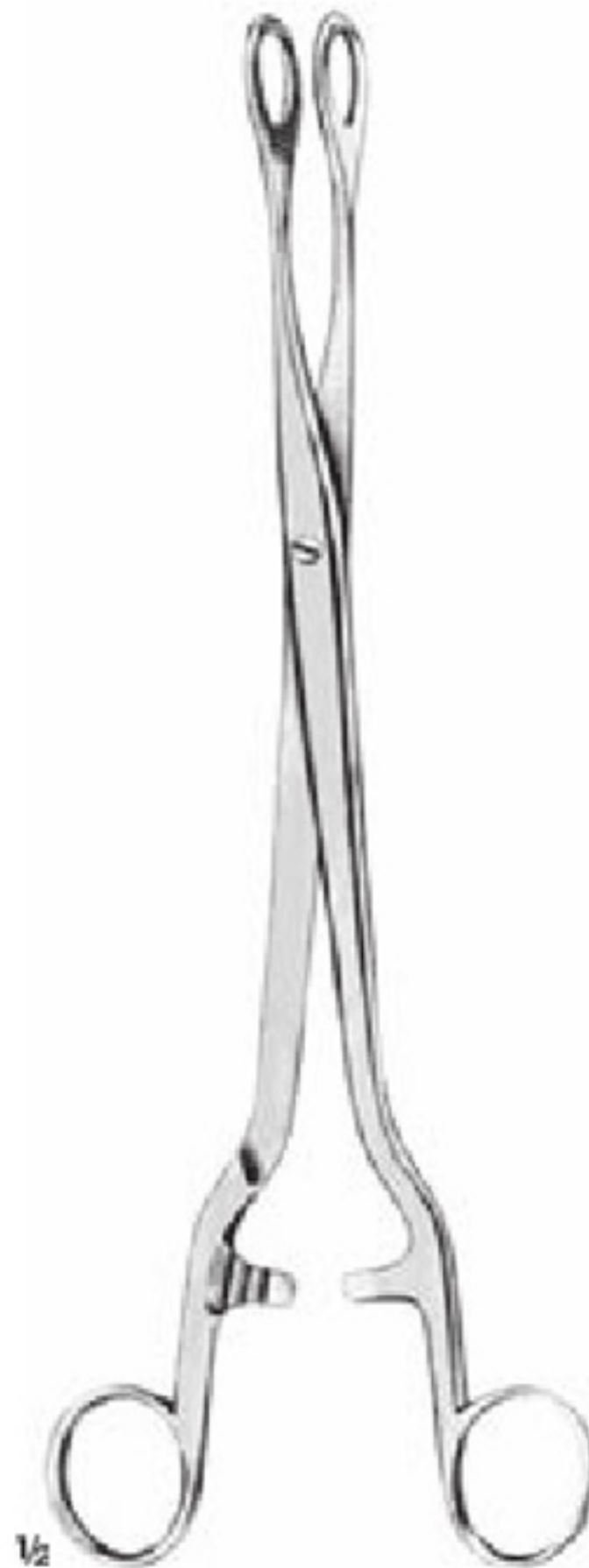

NOTO
EM-14-2214
28 cm



KELLY
EM-14-2215
32 cm

Atraumatic

21 mm 27 mm



1/2



1/2



EM-14-2218-01



EM-14-2218-02



1/2

HEYWOOD-SMITH
EM-14-2216
20 cm



1/2

DOYEN
EM-14-2217
18.5 cm



EM-14-2218-01 25 cm
EM-14-2218-02 27 cm

With movable jaws



$\frac{1}{2}$
SOMER
EM-14-2219
23.5 cm



$\frac{1}{2}$
DARTIGUES
EM-14-2220
25.5 cm



$\frac{1}{2}$
COLLIN
EM-14-2221
26.5 cm

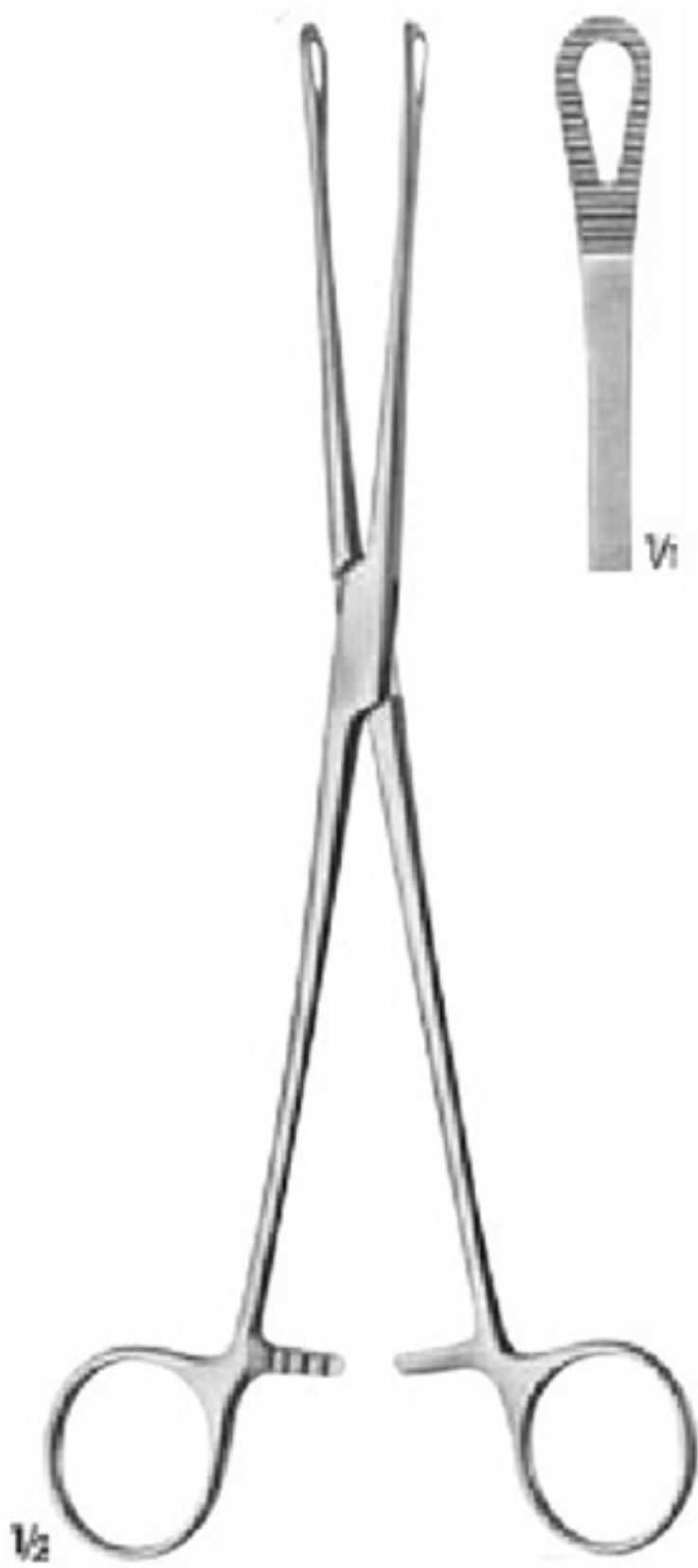

BONNEY
EM-14-2222
24 cm



COLLIN
EM-14-2223
25 cm



COLLIN
EM-14-2224
28.5 cm



$\frac{1}{2}$

EM-14-2225
Scalpel handle, angular curved
22.5 cm



$\frac{1}{2}$

DOYEN
EM-14-2226
Myoma screw
15 cm



$\frac{1}{2}$

DOYEN
EM-14-2227
Myoma screw
19 cm



KEIBACK
EM-14-2228-01 23.5 cm
EM-14-2228-02 35 cm
Ureteral tunnel clamps, curved to side



EM-14-2228-01
23.5 cm



EM-14-2228-02
35 cm



UCHIDA
EM-14-2229-01 27 cm
EM-14-2229-02 35 cm
Spoons



EM-14-2230-01 24 cm
EM-14-2230-02 35 cm

EM-14-2231-01 26 cm
EM-14-2231-02 35 cm

KIEBACK
EM-14-2230-01 - 2230-02
Parametrium scissors

KEIBACK
EM-14-2231-01 - 2231-02
Parametrium scissors, curved to side,
with 1 probe pointed blade



BURKE
EM-14-2232-01 - 2232-02
Parametriyum pensler, kısa ağızlı
Parametrium clamps, short jaw part



BURKE
EM-14-2233-01 - 2233-02
Parametriyum pensler, uzun ağızlı
Parametrium clamps, long jaw part

Malleable

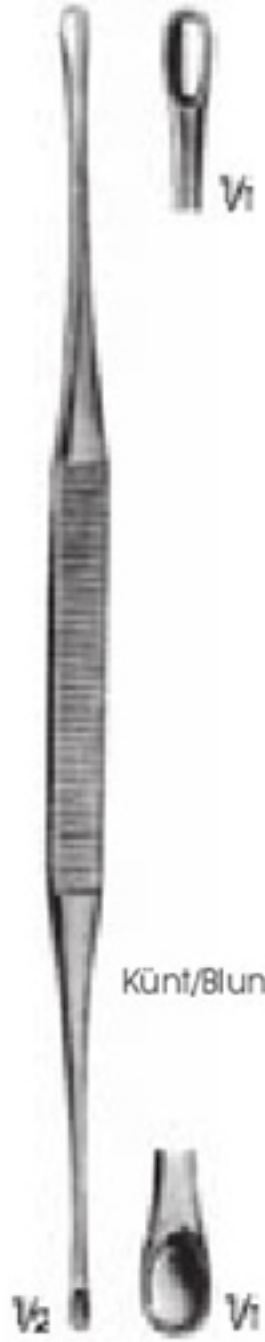

ASCH
EM-14-2234
Kaşık/Scoop
20 cm



RANDALL
EM-14-2235
Biyopsi küreti
Biopsy curette
24 cm



NOVAK-SCHOECKAERT
EM-14-2236
Biyopsi küreti
Biopsy curette
24 cm



BERLIN
EM-14-2237-01
Biyopsi küreti
Biopsy curette
27 cm



MÜNCHEN
EM-14-2237-02
Biyopsi küreti
Biopsy curette
27 cm



SAUNDERS
EM-14-2238
Çıkarma huk
Removing hook
32 cm

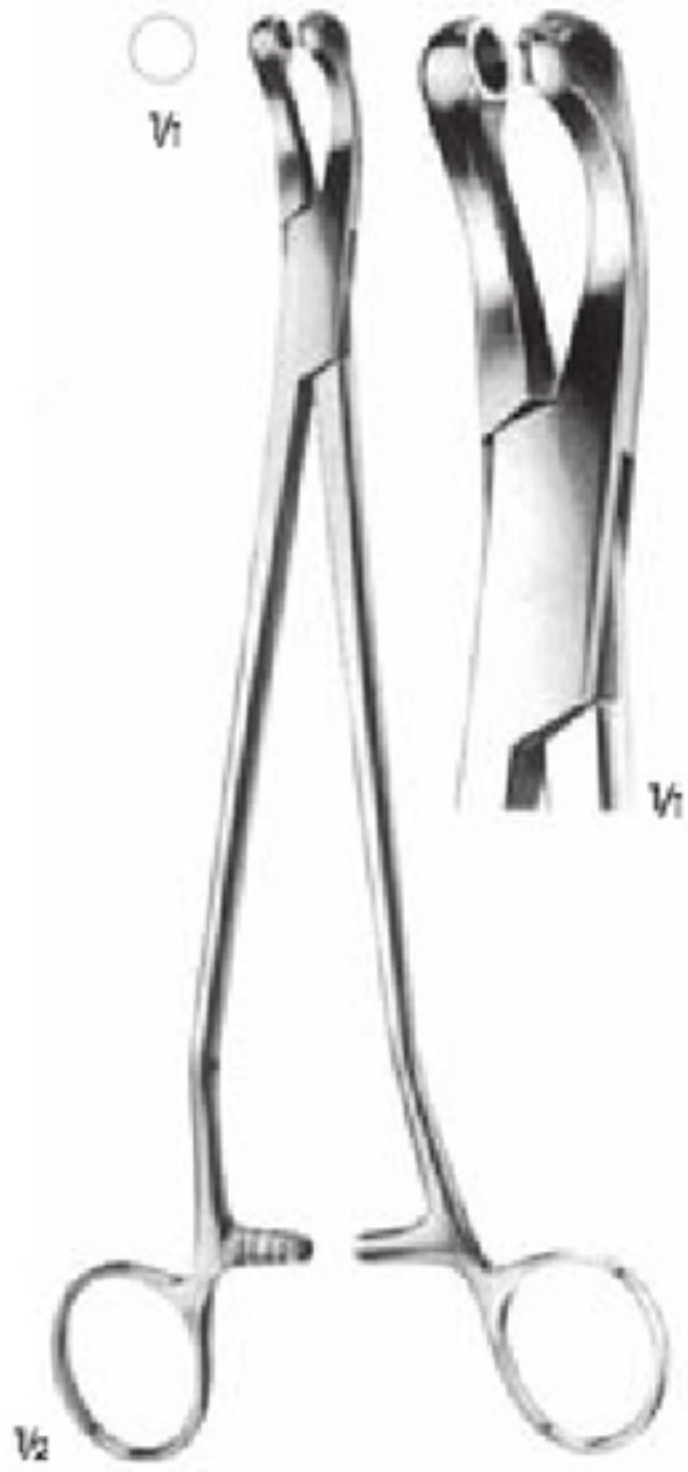

THOMS-GAYLOR
EM-14-2239
24 cm

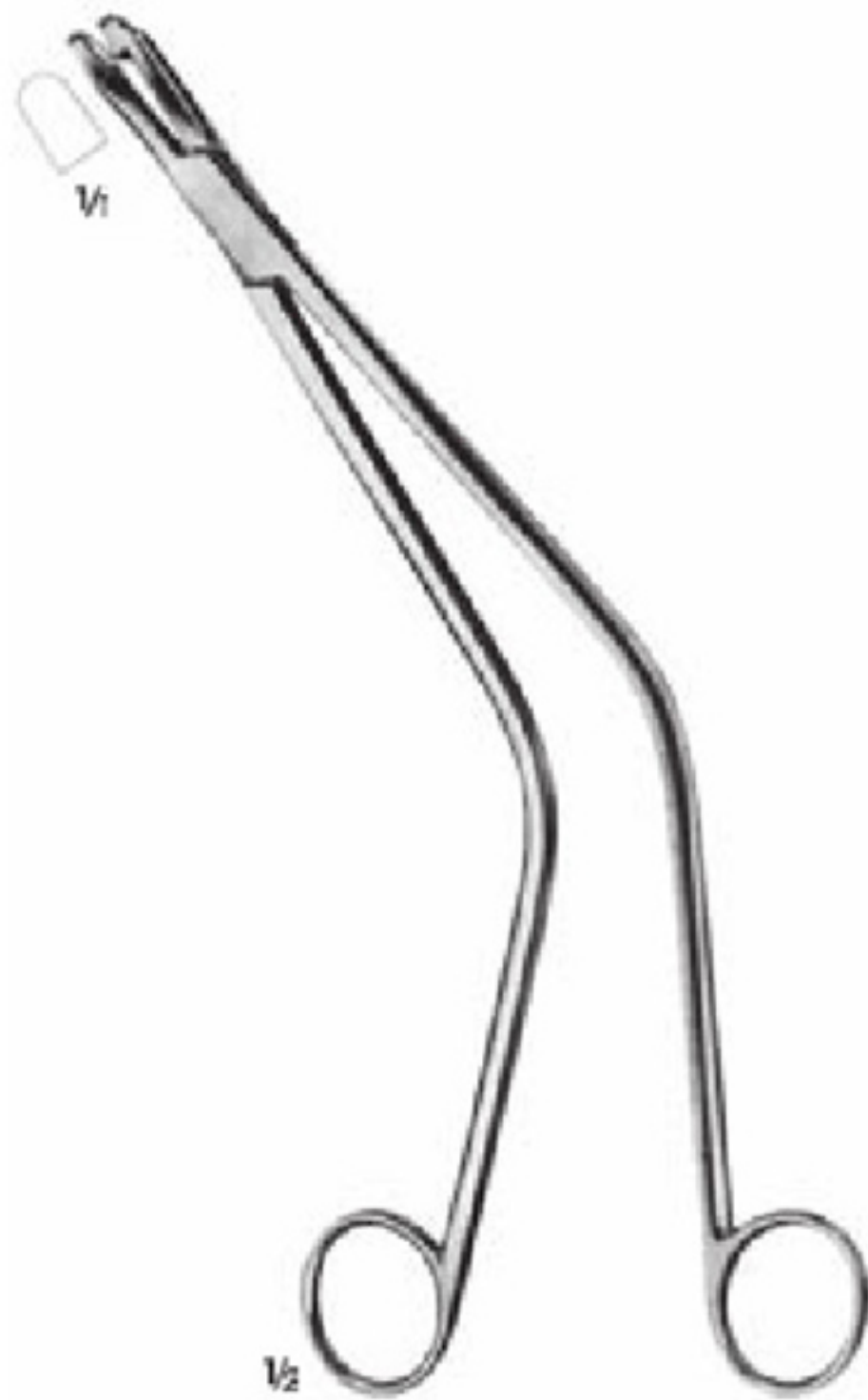

SCHUBERT
EM-14-2240
26 cm



FAURE
EM-14-2241-01
21 cm



FAURE
EM-14-2241-02
24 cm

Çengel ağız ile daha güvenilir tutuş sağlar.
Ağız geniş açılabilir.
Düzgün ve uygun kesme sağlar.
Deforme olmamış ezilmemiş parça alınmasına imkan verir.
Travma'ya neden olmaması nedeni ile iyileşme çabuk olur.
More reliable grip on the tissue due to 'hooking' effect.
Wide angle of opening.
Smooth, steady cut.
Specimens are not squashed.
Not painful; self-wound, heals well.

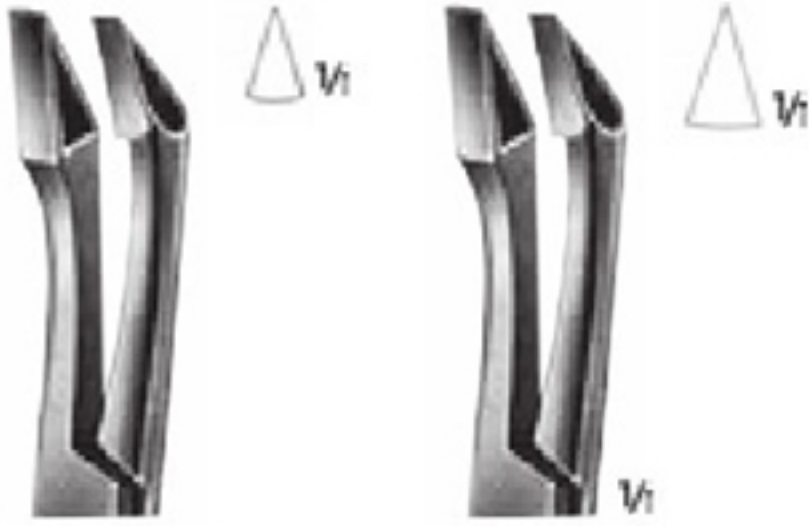

EM-14-2242-01

EM-14-2242-02

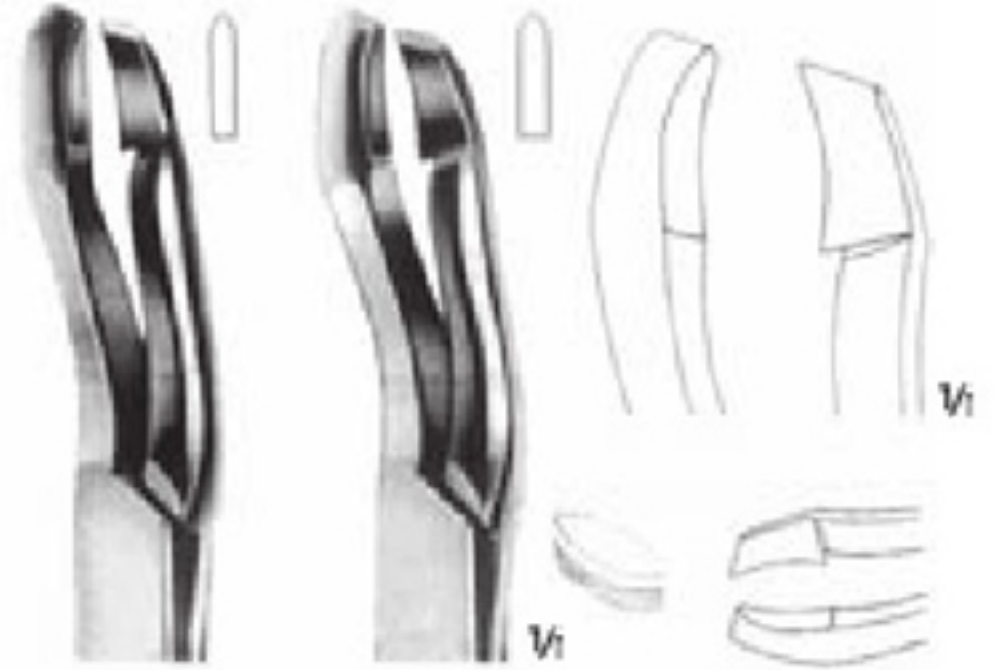

EM-14-2243-01
2 mm

EM-14-2243-02
2.4 mm

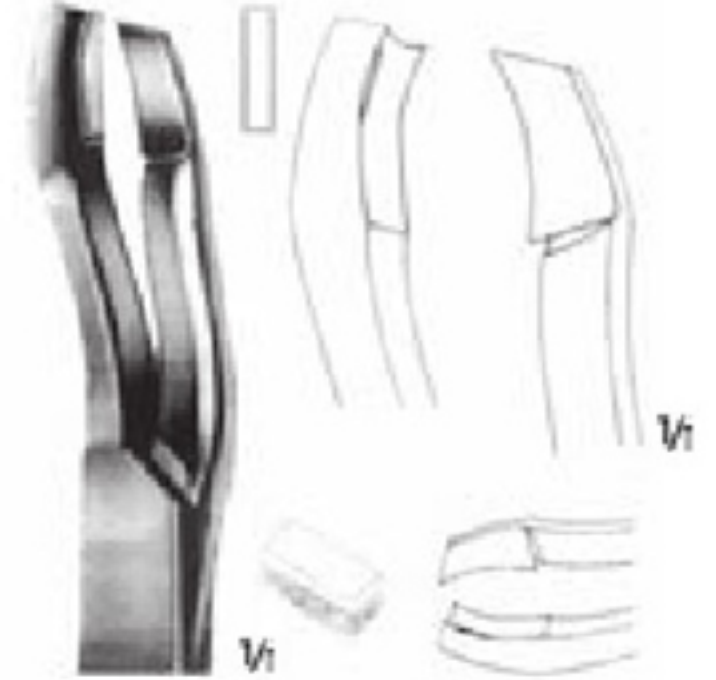

EM-14-2244
2.4 mm



SCHUMACHER
EM-14-2242-01 - 2242-02
24 cm



SEIDL DBP
EM-14-2243-01 - 2244
Bayonet-Shaped biopsy forceps
24 cm

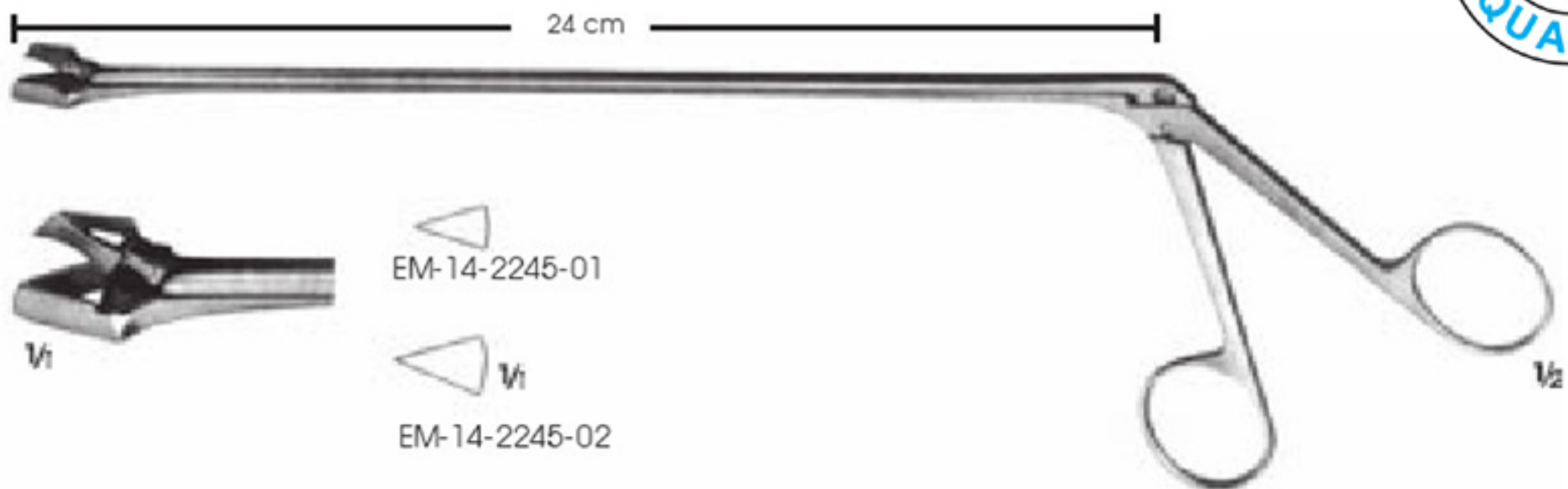

SCHUMACHER
EM-14-2245-01 - 2245-02
Suitable for colposcopy
24 cm



EPPENDORF
EM-14-2246
Suitable for colposcopy
20 cm

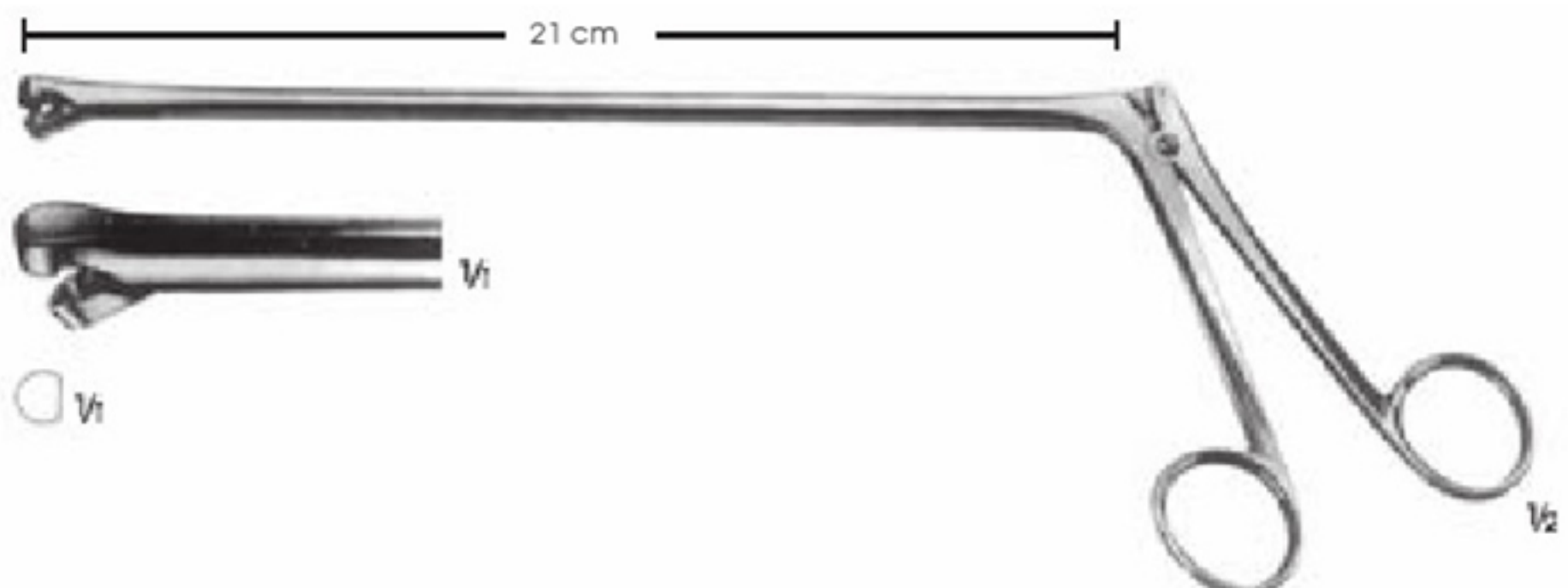

BERGER
EM-14-2247
21 cm



LEECH-WILKINSON
EM-14-2248

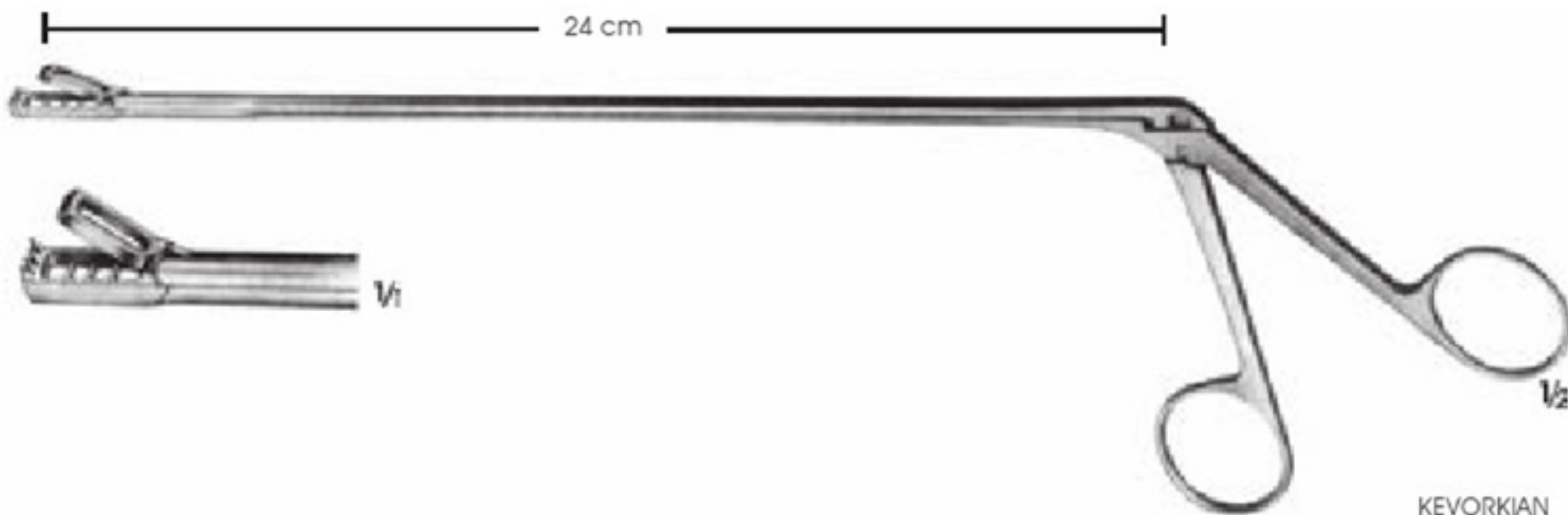

KEVORKIAN
EM-14-2249
24 cm

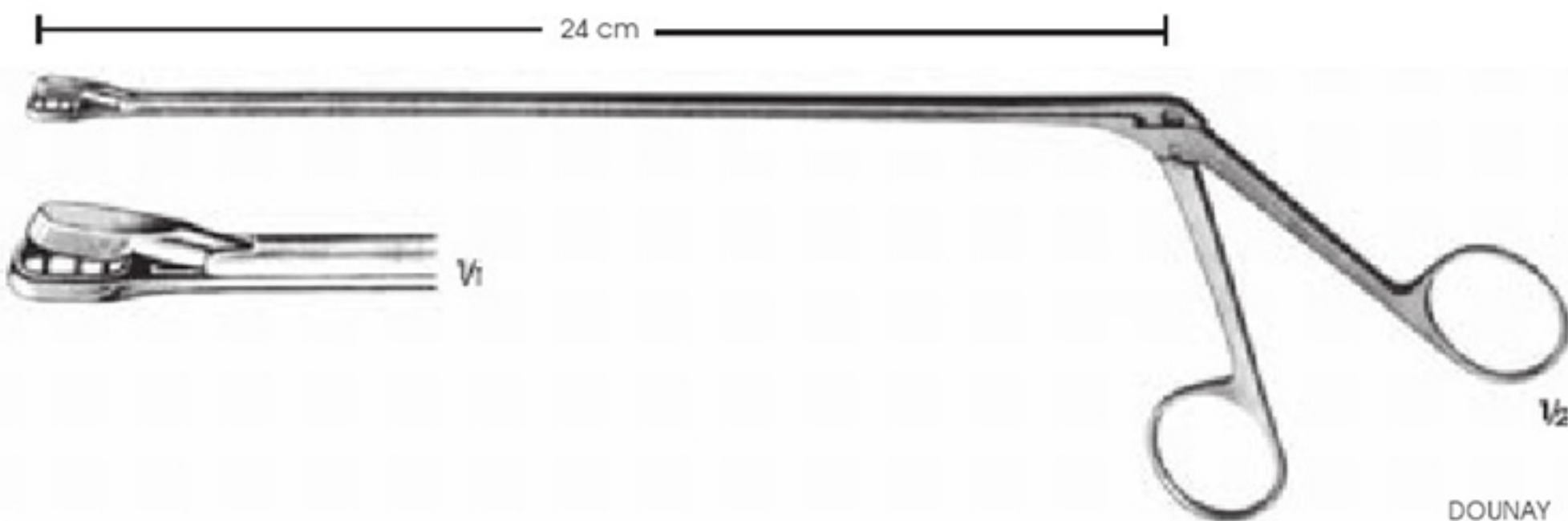

DOUNAY
EM-14-2250
24 cm



EM-14-2251-01 - 2251-02

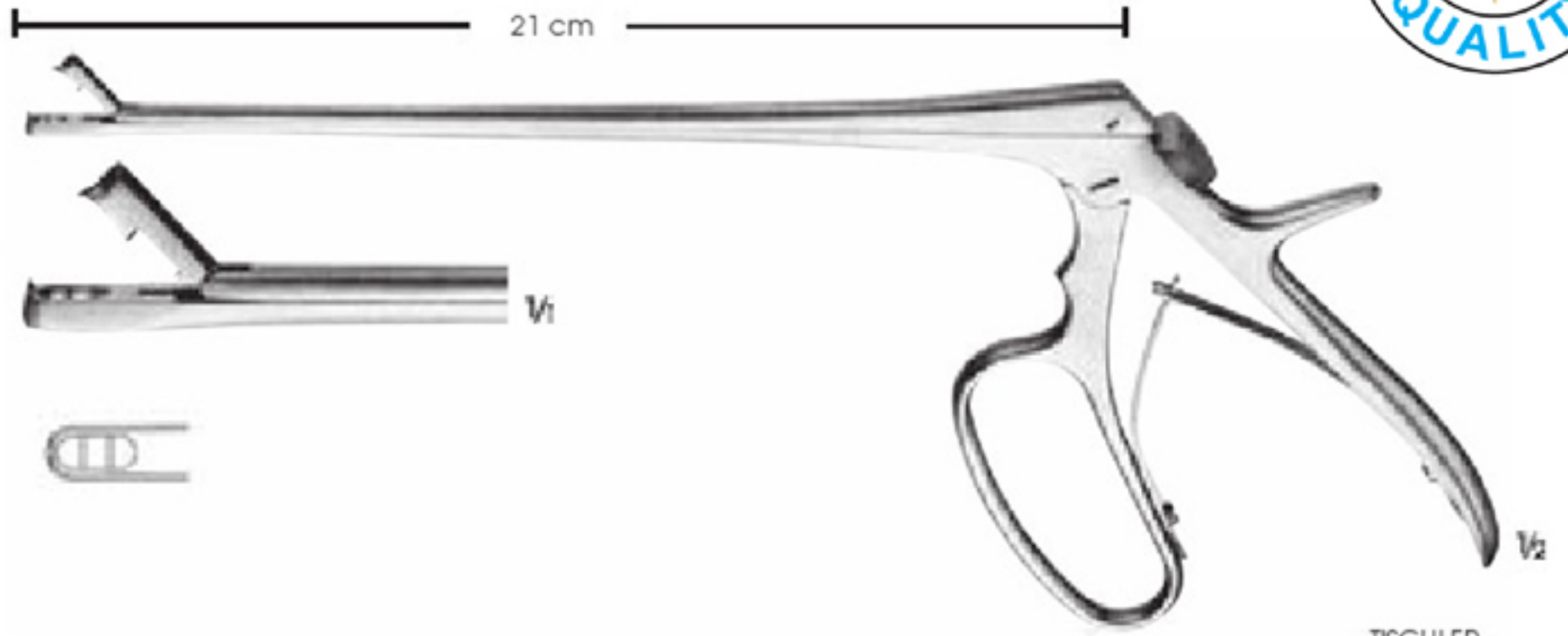

TISCHLER
EM-14-2252

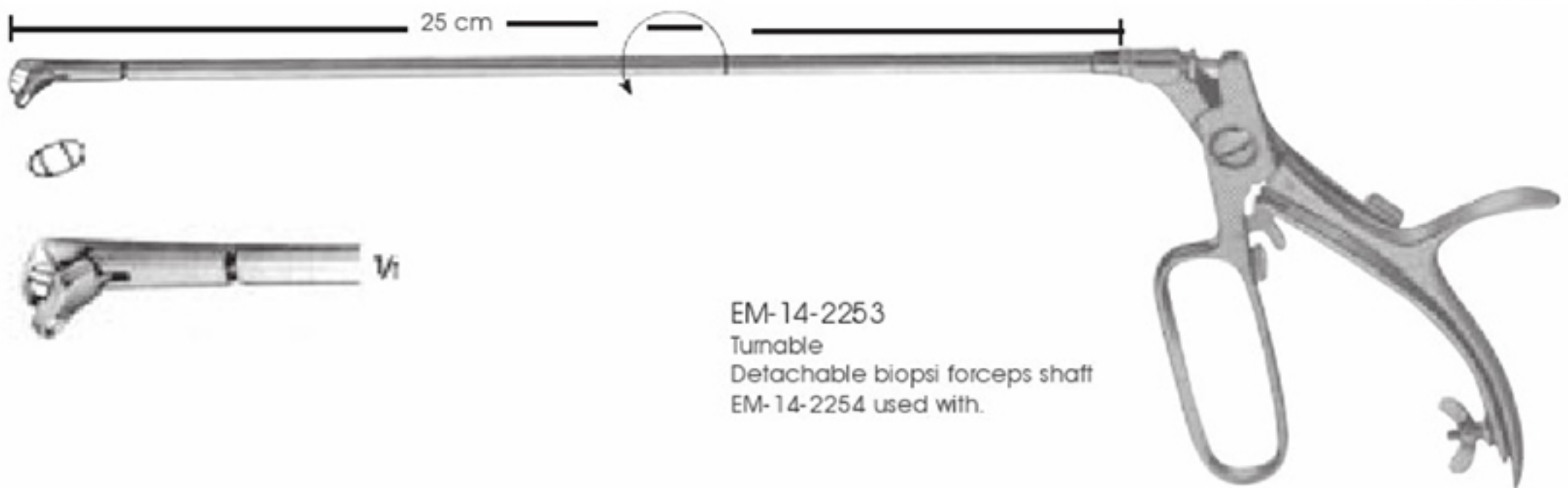

EM-14-2253
Turnable
Detachable biopsy forceps shaft
EM-14-2254 used with.



EM-14-2254
Universal sap
Universal handle
14 cm



HUBER
EM-14-2255
Universal sap
Universal handle
14 cm



BRÜNNINGS
EM-14-2256-01 20 cm
EM-14-2256-02 25 cm
Extension cannula















EM-14-2257-01 EM-14-2257-02



KRAUSE
EM-14-2257-01 - 2257-02
Biopsy tips

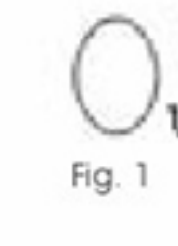

SCHUMACHER
EM-14-2258
Biopsy tip

					14 mm	
		EM-14-2259-06 14.5 mm				EM-14-2261-05
	Fig. 6			Fig. 6		
		EM-14-2259-05 13 mm			12 mm	EM-14-2261-04
	Fig. 5			Fig. 5		
		EM-14-2259-04 11.5 mm			10 mm	EM-14-2261-03
	Fig. 4			Fig. 4		
		EM-14-2259-03 10 mm			8 mm	EM-14-2261-02
	Fig. 3			Fig. 3		
		EM-14-2259-02 8.5 mm			6 mm	EM-14-2261-01
	Fig. 2			Fig. 2		
		EM-14-2259-01 6.8 mm				
	Fig. 1			Fig. 1		
$\frac{1}{2}$			$\frac{1}{2}$			
SIMON			SCHRÖDER			GOURDET
EM-14-2259-01 - 2259-06			EM-14-2260-01 - 2260-06			EM-14-2261-01 - 2261-05
24 cm			31 cm			Blunt 28 cm



RECAMIER
EM-14-2262-01 - 2262-12
Sharp-Rigid
EM-14-2263-01 - 2263-08
Sharp-Malleable
EM-14-2264-01 - 2264-11
Blunt-Rigid
30 cm



EM-14-2262-06
EM-14-2264-05
21.5 mm



EM-14-2262-12
EM-14-2264-11
23.5 mm



EM-14-2262-05
EM-14-2263-04
EM-14-2264-04
18 mm



EM-14-2262-11
EM-14-2263-08
EM-14-2264-10
19.5 mm



EM-14-2262-04
EM-14-2263-03
EM-14-2264-03
15 mm



EM-14-2262-10
EM-14-2263-07
EM-14-2264-09
16.5 mm



EM-14-2262-03
EM-14-2263-02
EM-14-2264-02
12 mm



EM-14-2262-09
EM-14-2263-06
EM-14-2264-08
14 mm



EM-14-2262-02
EM-14-2263-01
EM-14-2264-01
8.5 mm





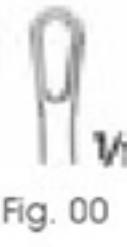













EM-14-2262-08
EM-14-2263-05
EM-14-2264-07
10.5 mm

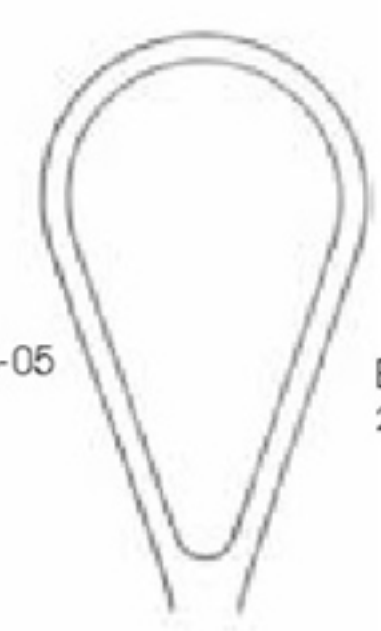

EM-14-2262-01
4.5 mm

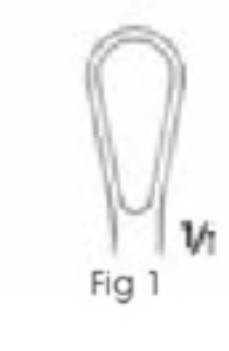

EM-14-2262-07
EM-14-2264-06
7.5 mm

		EM-14-2265-06 EM-14-2266-06 EM-14-2267-06 15 mm			EM-14-2268-07 28.5 mm		
		EM-14-2265-05 EM-14-2266-05 EM-14-2267-05 14 mm					
		EM-14-2265-04 EM-14-2266-04 EM-14-2267-04 12 mm			EM-14-2268-05 23.5 mm		EM-14-2268-06 26 mm
		EM-14-2265-03 EM-14-2266-03 EM-14-2267-03 10.5 mm				EM-14-2268-03 19.5 mm	EM-14-2268-04 21.5 mm
		EM-14-2265-02 EM-14-2266-02 EM-14-2267-02 8.5 mm					
		EM-14-2265-01 EM-14-2266-01 EM-14-2267-01 7.5 mm				EM-14-2268-01 16 mm	EM-14-2268-03 18 mm
	SIMS EM-14-2265-01 - 2265-06 Sharp-Rigid EM-14-2266-01 - 2266-06 Sharp-Malleable EM-14-2267-01 - 2267-06 Blunt-Rigid 25.5 cm				BUMM EM-14-2268-01 - 2268-07 Blunt-Malleable 29 cm		



RECAMIER
EM-14-2269-01 - 2269-02
Blunt-Rigid
36 cm



Fig. 2

EM-14-2269-02
39.5 mm



Fig. 1

EM-14-2269-01
34.5 mm



Fig. 3

EM-14-2270-02
EM-14-2271-03
28.5 mm



BUMM
EM-14-2270-01 - 2270-02
Sharp-malleable
EM-14-2271-01 - 2271-03
Blunt-malleable
31 cm



Fig. 2

EM-14-2271-02
26 mm



Fig. 1

EM-14-2270-01
EM-14-2271-01
23.5 mm

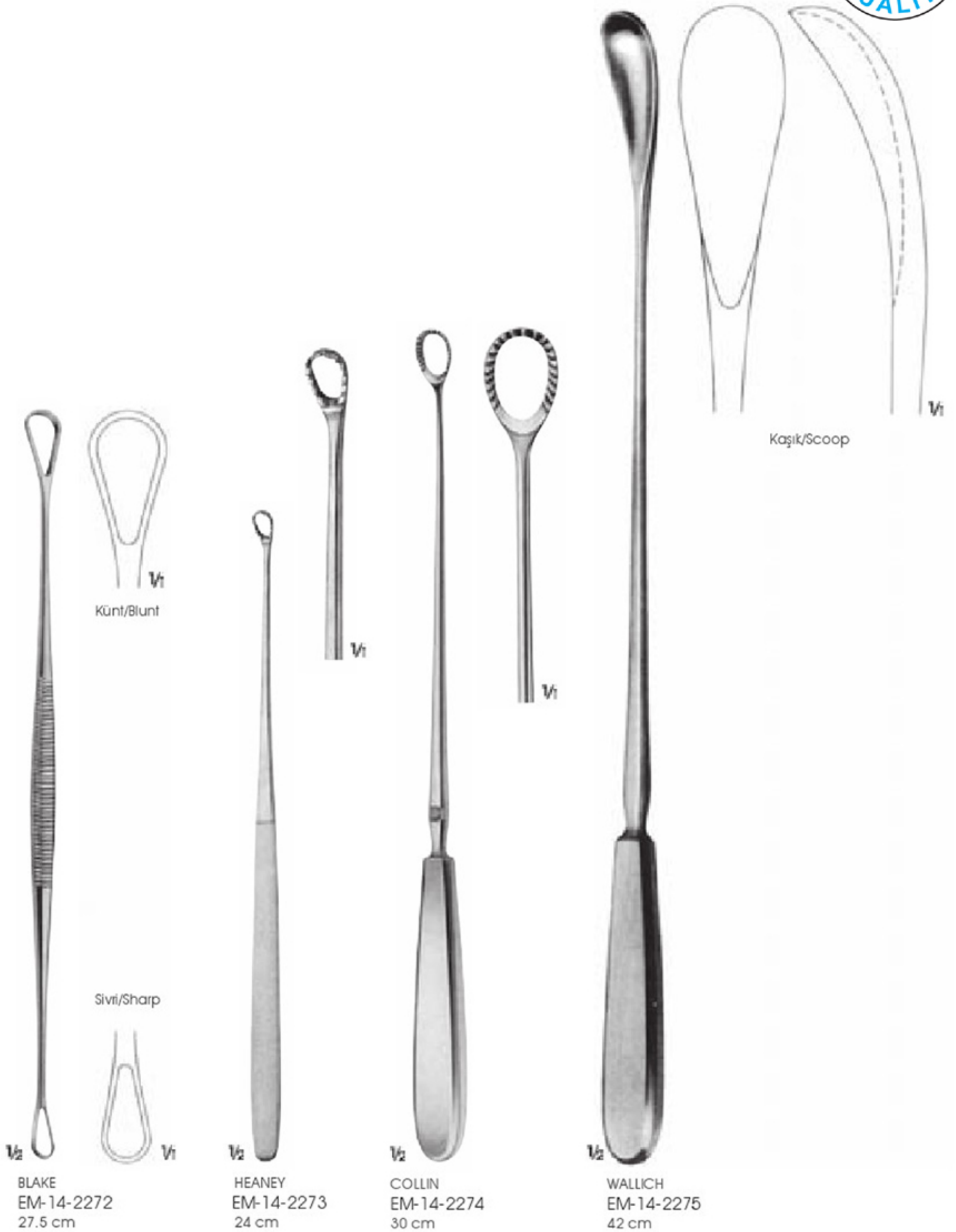

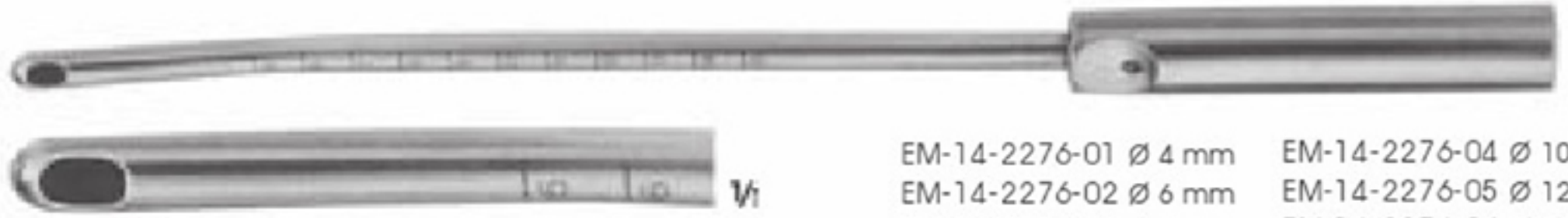

EM-14-2276-01 Ø 4 mm	EM-14-2276-04 Ø 10 mm
EM-14-2276-02 Ø 6 mm	EM-14-2276-05 Ø 12 mm
EM-14-2276-03 Ø 8 mm	EM-14-2276-06 Ø 14 mm



EM-14-2277
Hose connection, straight
inside diam Ø 11mm

EM-14-2278
inside diam Ø 11mm



EM-14-2279-01 40 mm
EM-14-2279-02 50 mm
EM-14-2279-03 60 mm
With traction handle
134°C Autoclavable

Function:

The vacuum required can be constantly preset by the adjusting screw. This vacuum exists then up to the closed quick-shutter, thus the vacuum in the suction head is pressed from the left to the right, the nounted suction head is immediately put under the preset vacuum. In case the preset vacuum has to be changed, this can be done with the adjusting screw. For immediate removal of the suction head simply close the quick-shutter, thus the vacuum in the suction head is eliminated at once whereas the vacuum in the suction jar remains unchanged.



EM-14-2279-04
Hand valve with connection hose
20 cm long connection hose

SCHULZE
EM-14-2280-05
Tip



SCHULZE
EM-14-2280-04
Tip



EM-14-2280-03
Tip



SCHULZE
EM-14-2280-02
37.5 cm

SCHULZE
EM-14-2280-01 Complete
EM-14-2280-02
EM-14-2280-03 - 2280-05
Salpingography uterine cannula



EM-14-2281-03
Large
Ø 16 x 30 mm



EM-14-2281-02
Medium
Ø 13 x 30 mm



EM-14-2281-01
Small
Ø 10 x 25 mm



LEECH-WILKINSON
EM-14-2281-01 - 2281-03
Uterine cannula
26.5 cm



EM-14-2282
Uterine cannula with spring
connector, self-retaining complete with
2 interchangeable cones large and small
25 cm



SPACKMAN
EM-14-2283
With adjustable plate for
vulsillum forceps
36 cm



BEHRMAN
EM-14-2284
Uterine cannula with
detachable cone
30.5 cm



ROTUNDA
EM-14-2285
Irrigation cannula
20 cm

Special set for transvaginal injection for
paracervical anesthesia as well as
anesthesia of the pudendus



EM-14-2286
Guide sheath
17.5 cm

EM-14-2287
Injection needle
Luer-lock
1,0 x 18.5 cm



DE LEE
EM-14-2288
Pelvimeter centimeters and inches
measured



MARTIN
EM-14-2289
Graduated in centimeters



$\frac{1}{2}$
 BEACHAM
 EM-14-2290
 Amniotome
 24 cm



EM-14-2291
 Pouch opener
 44 cm



$\frac{1}{2}$
 HERFF
 EM-14-2292
 Zar delici pens
 Membrane puncturing forceps
 25.5 cm

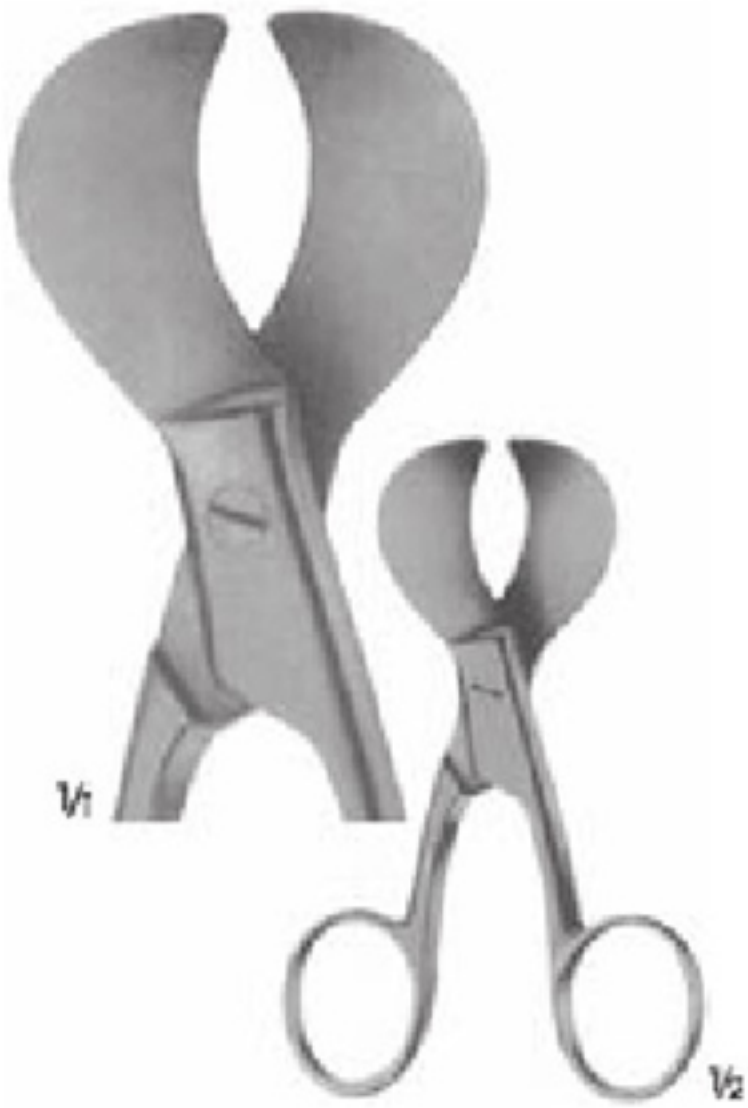

EM-14-2293
Umbilical cord scissors
10.5 cm



SCHUMACHER
EM-14-2294
Umbilical cord scissor
15.5 cm

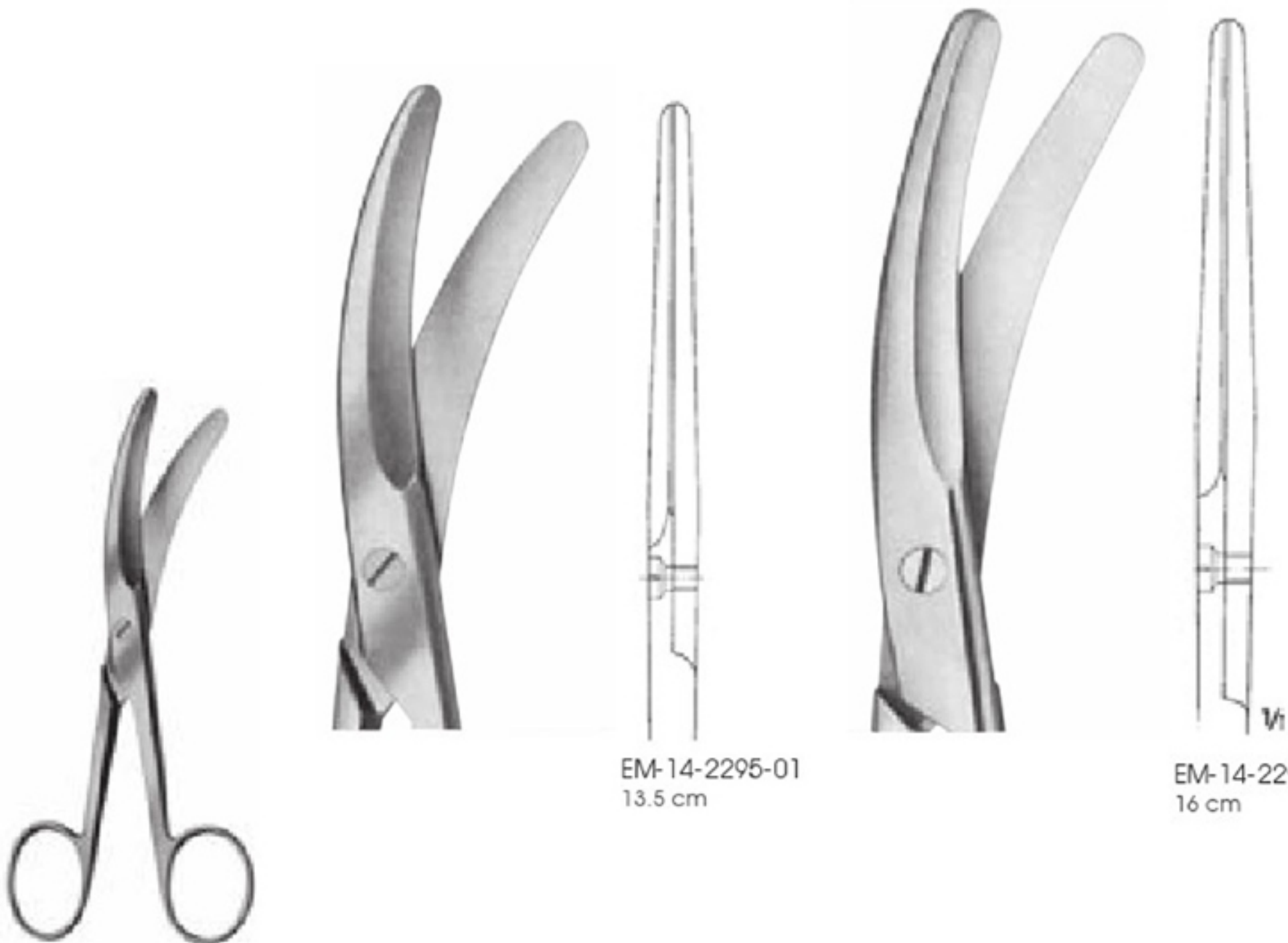

EM-14-2295-01
13.5 cm

EM-14-2295-02
16 cm

EM-14-2295-01 - 2295-02
Umbilical cord scissors



BRAUN-STADLER
 EM-14-2296-01 - 2296-02
 Episiotomy scissors



EM-14-2296-01
 14.5 cm



EM-14-2296-02
 20 cm



EM-14-2297
 Episiotomy scissors
 24 cm

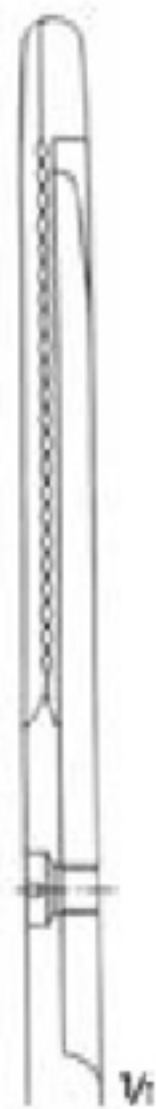

V₁



EM-14-2298
 Umbilical dilator
 9.5 cm

V₁



COLLIN
 EM-14-2299
 Umbilical cord clamp
 8.5 cm

V₂



$\frac{1}{2}$
SIMPSON
EM-14-2300
For caesarean section
23.5 cm



$\frac{1}{2}$
SIMPSON-BRAUN
EM-14-2301
30.5 cm



$\frac{1}{2}$
SIMPSON-BRAUN
EM-14-2302
35 cm



$\frac{1}{2}$
NAGELE
EM-14-2303
35.5 cm



WRIGLEY
EM-14-2304
For caesarean section
25 cm



SELHEIM
EM-14-2305
Obstetric lever
30 cm



KIELLAND
EM-14-2306
42 cm



PIPER
EM-14-2307
44.5 cm



TARNIER
EM-14-2308
With traction rod
40 cm



BARNES-NEVILLE
EM-14-2309
With traction handle
43.5 cm



WILLETT
EM-14-2310
Scalp flap forceps
18.5 cm

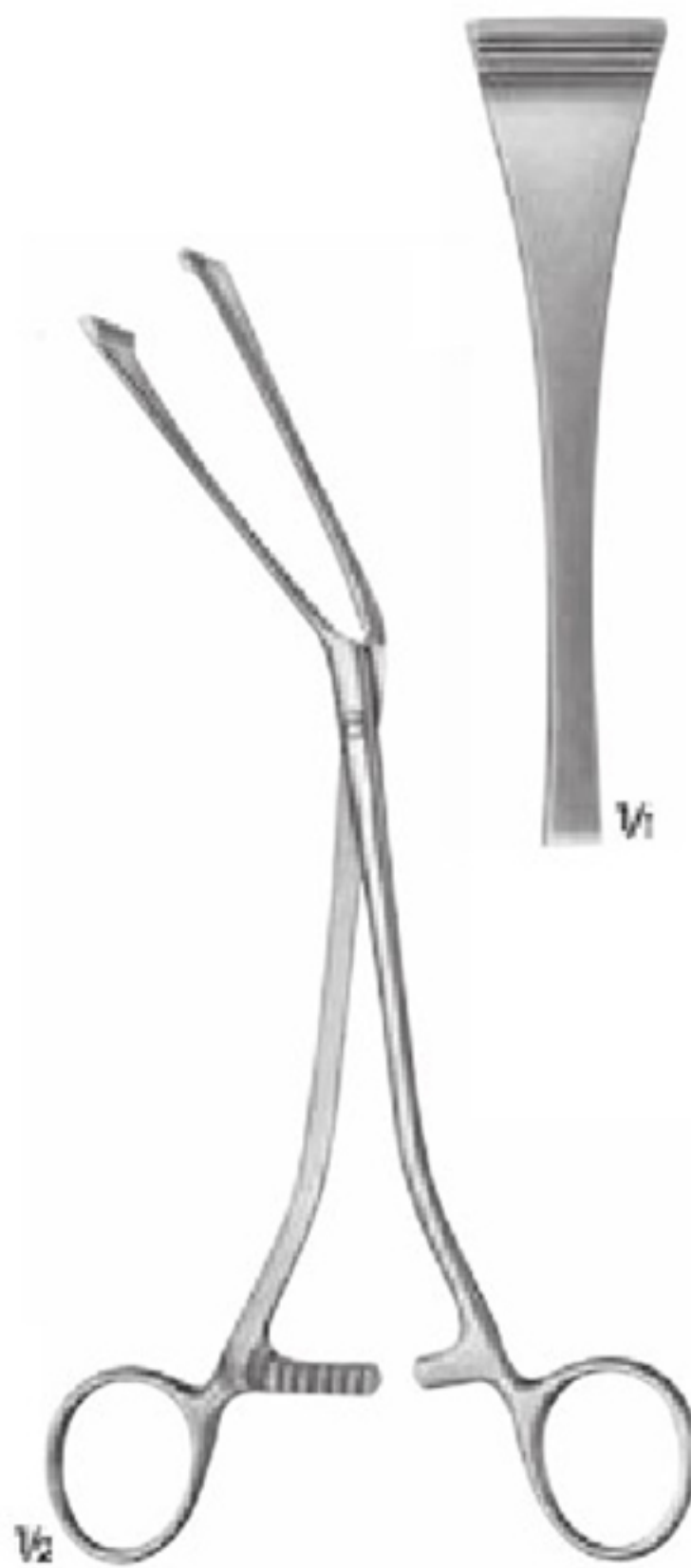

GREEN-ARMYTAGE
EM-14-2311
Caesarean hemostatic forceps,
angled
19.5 cm

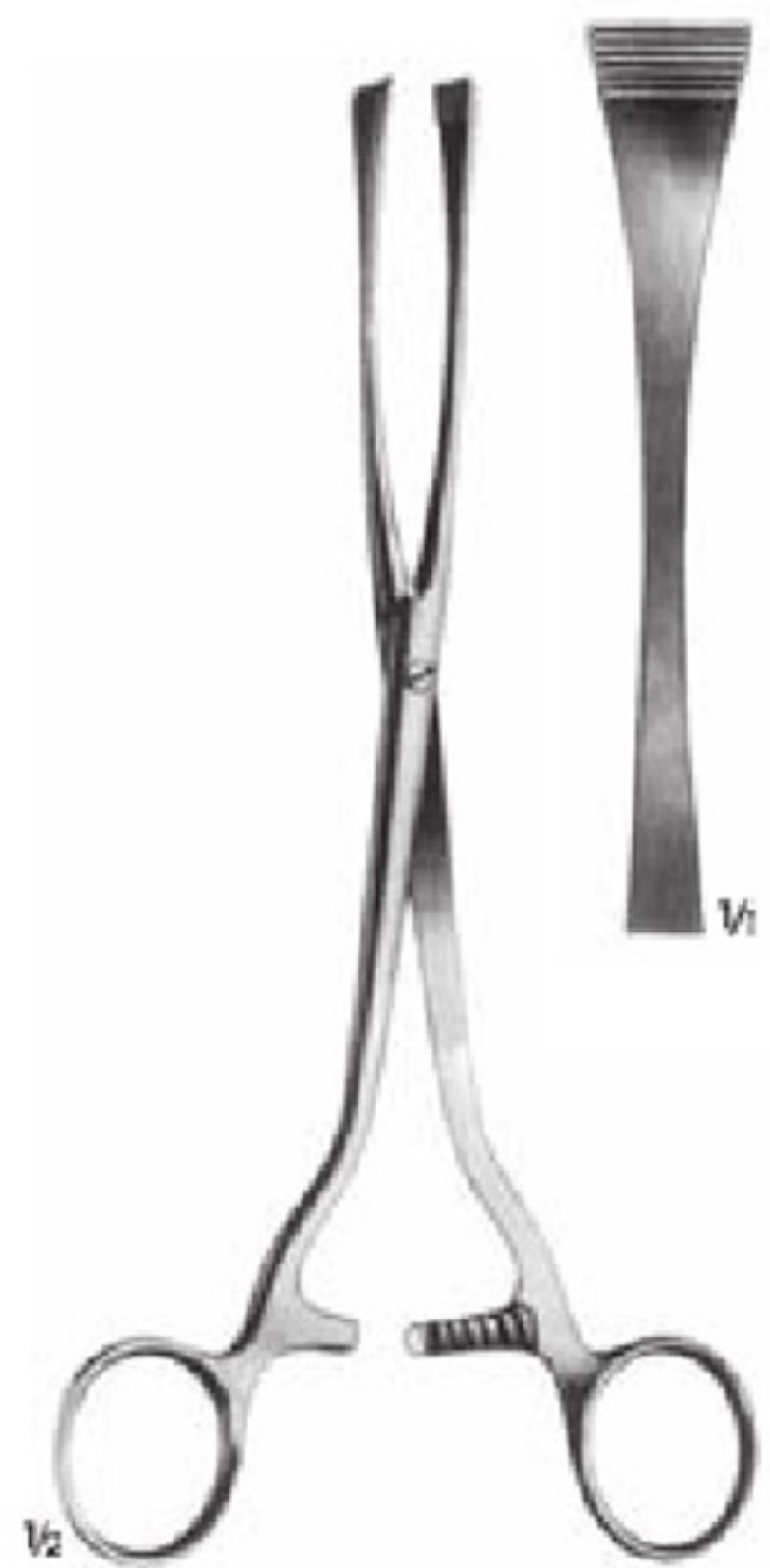

GREEN-ARMYTAGE
EM-14-2312
Caesarean hemostatic forceps,
straight
22 cm



EM-14-2313-01 EM-14-2313-02



EM-14-2314-01 EM-14-2314-02 EM-14-2314-03



EM-14-2315-01 EM-14-2315-02



WINTER
 EM-14-2313-01 - 2313-02
 29 cm



WINTER
 EM-14-2314-01 - 2314-03
 29 cm



WINTER
 EM-14-2315-01 - 2315-02
 With ratchet
 29 cm

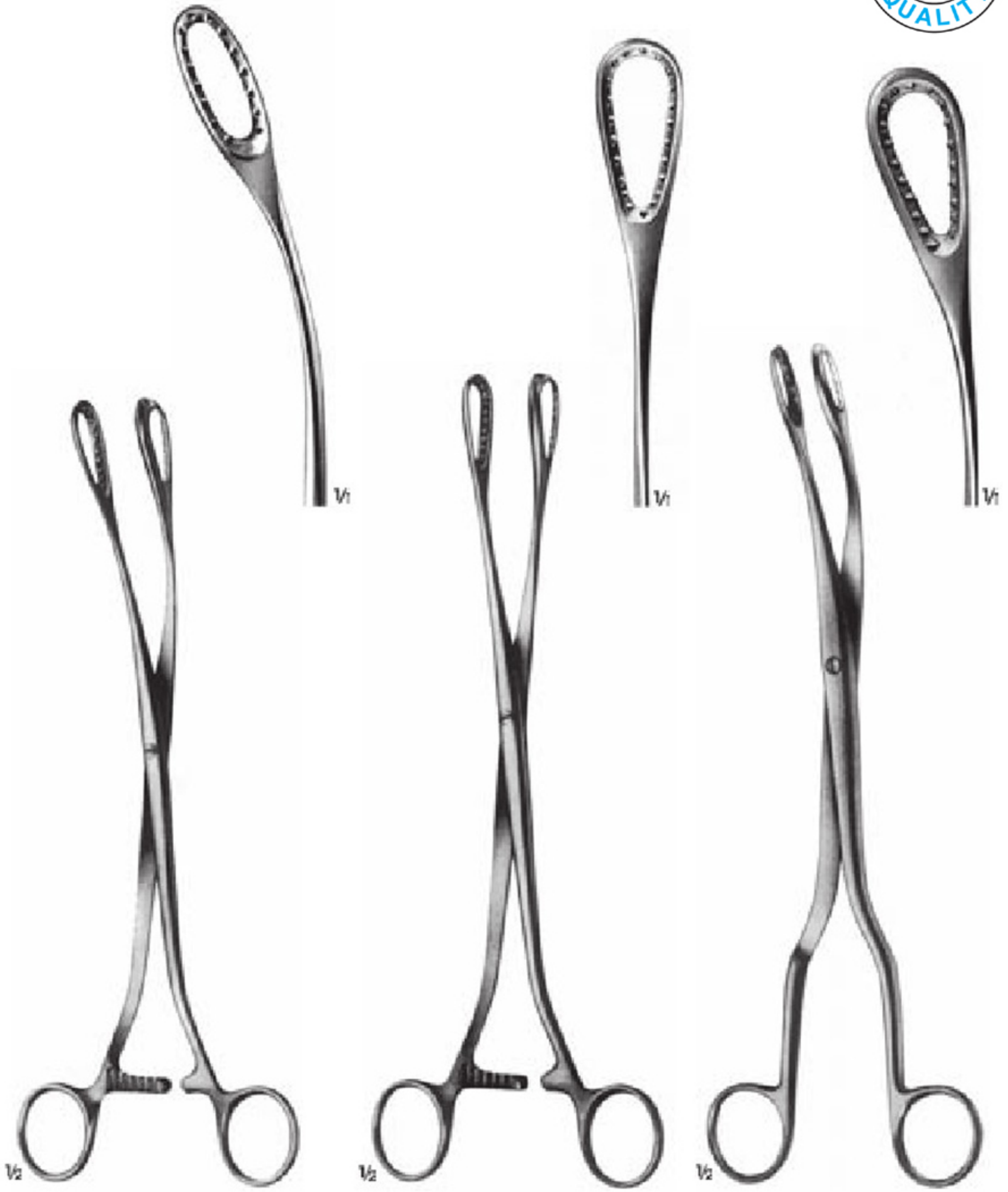

SAENGER
EM-14-2316
26.5 cm

SAENGER
EM-14-2317
27.5 cm

SAENGER
EM-14-2318
28.5 cm

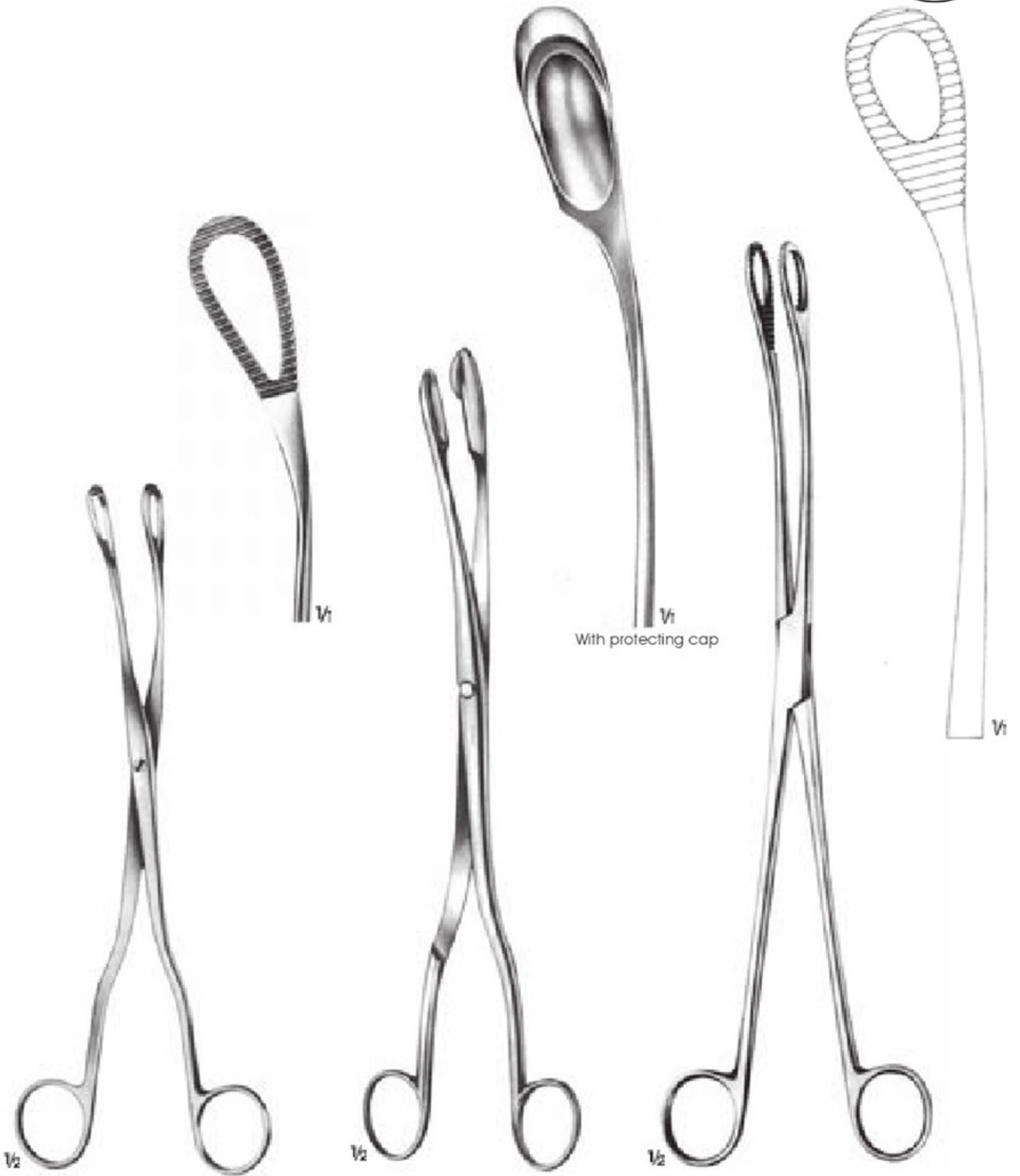

MC. CLINTOCK
EM-14-2319
24 cm

EM-14-2320
28.5 cm

KELLY
EM-14-2321
32 cm

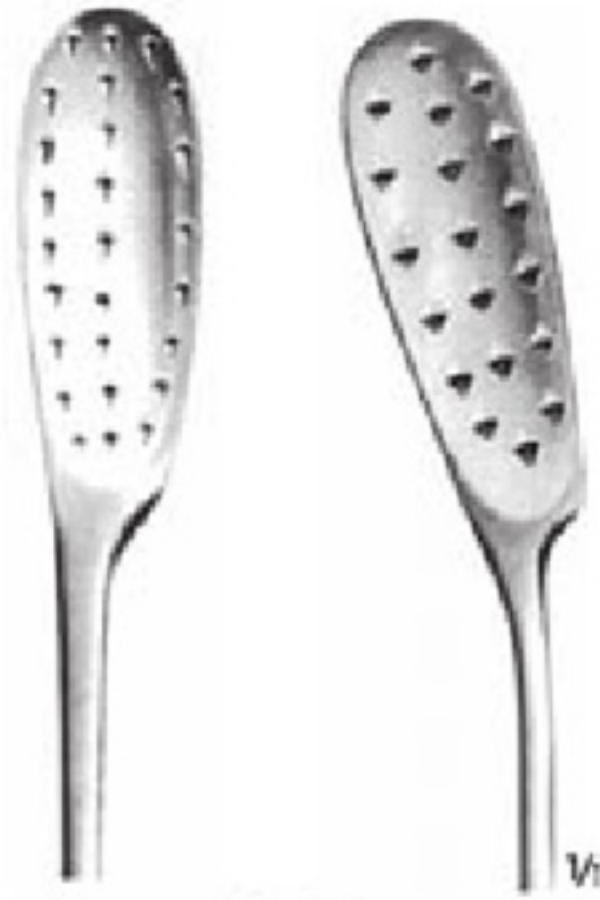

1/1



1/1



1/2



1/2



1/3

SMELLIE
 EM-14-2322
 27 cm

LEWKOWITZ
 EM-14-2323 EM-14-2324
 24.5 cm

BOER
 EM-14-2325
 29 cm