

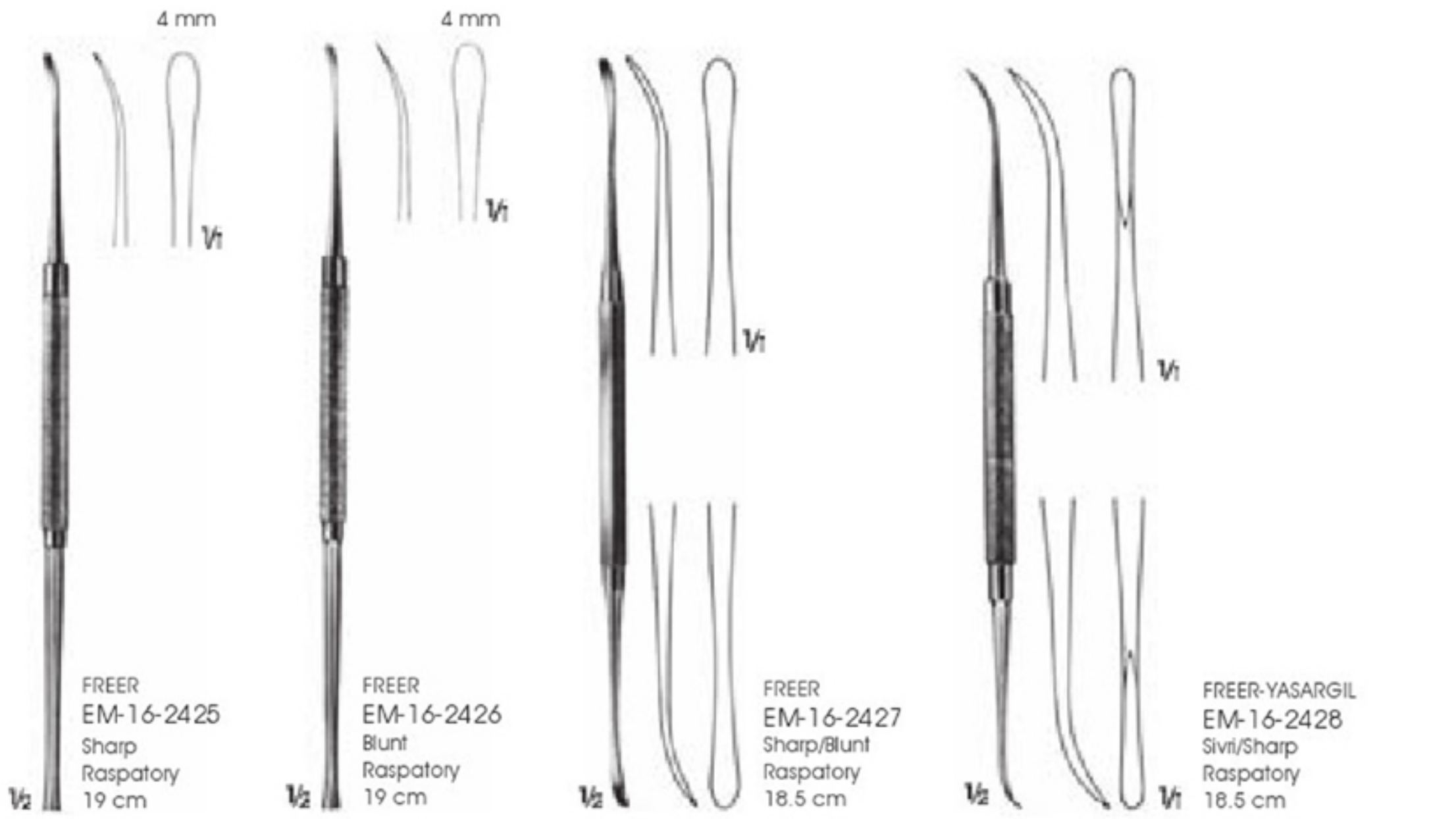

Respiratories, Dissectors And Levers

Respiratorien, Dissektoren Und Hebel

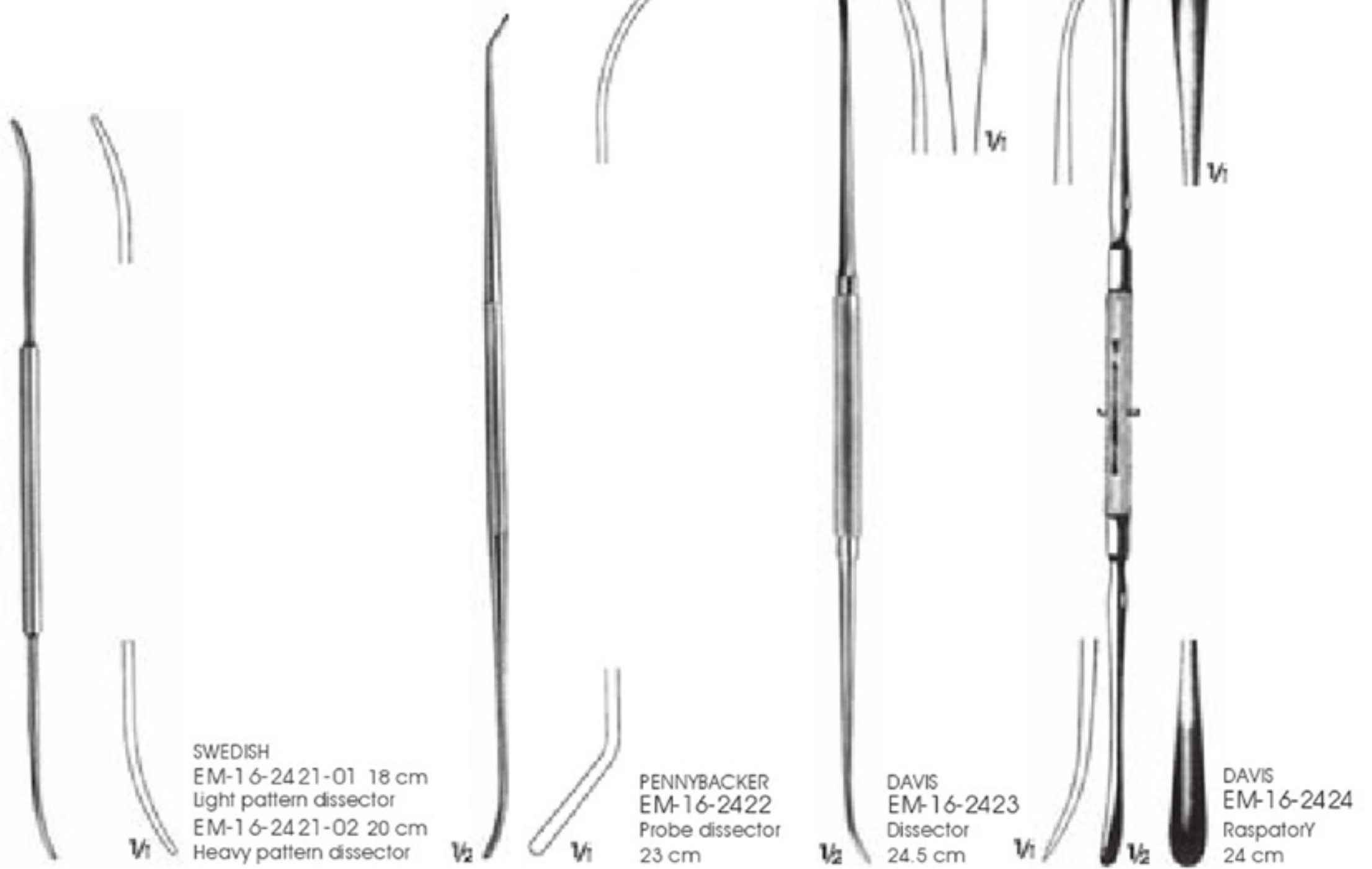

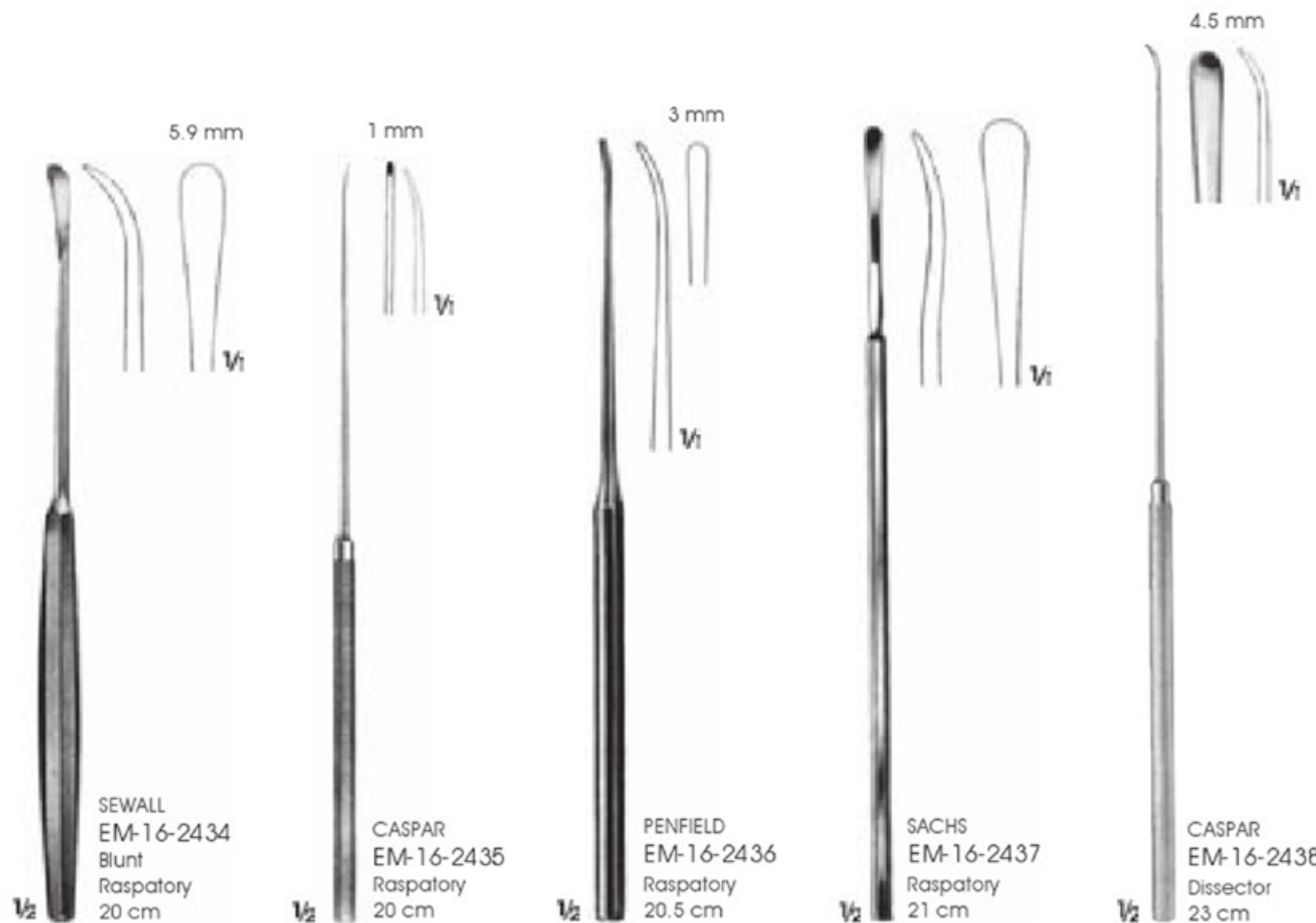
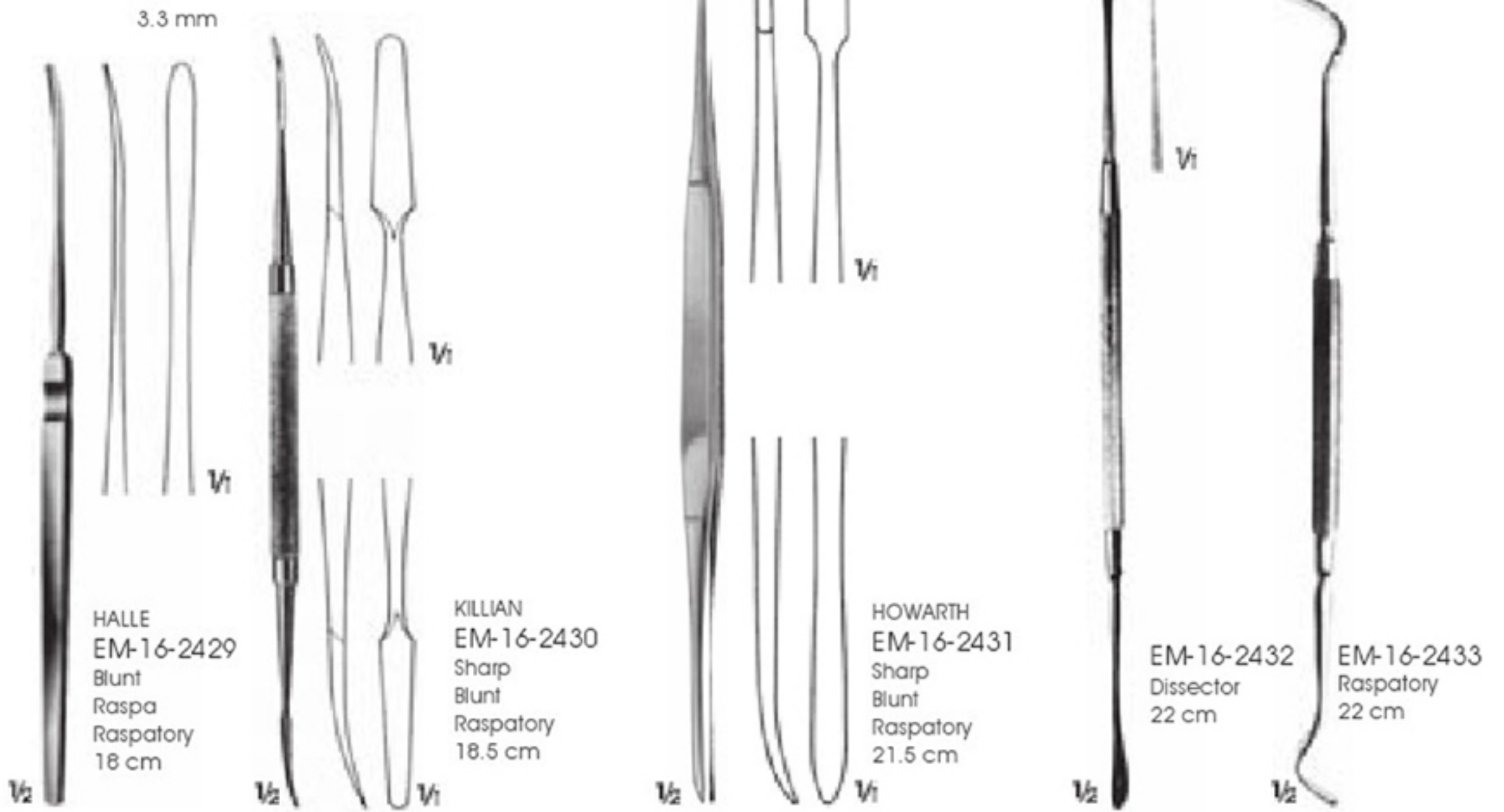

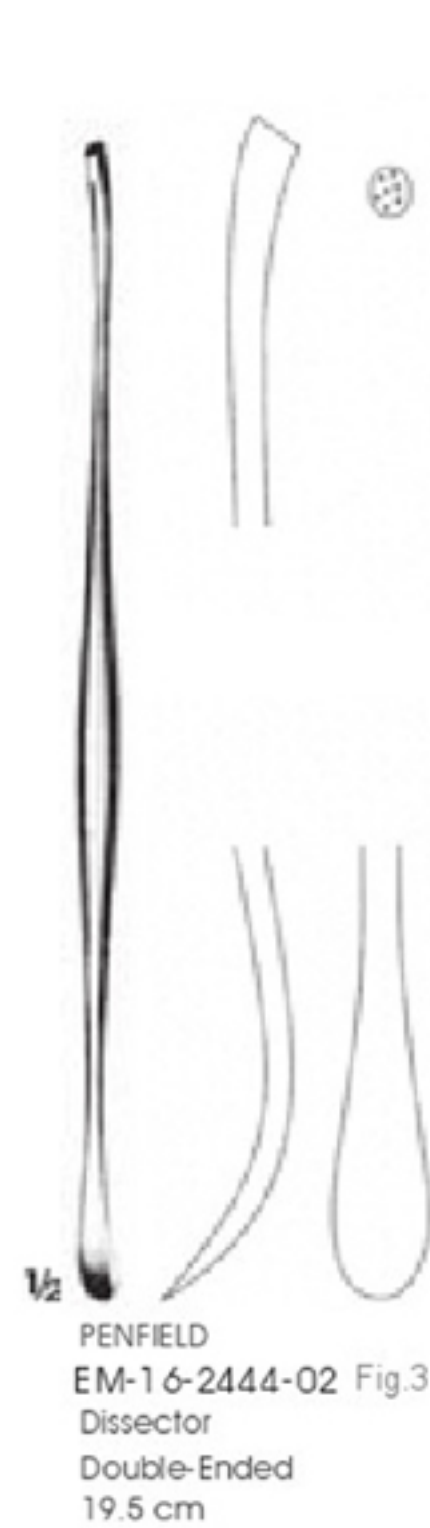
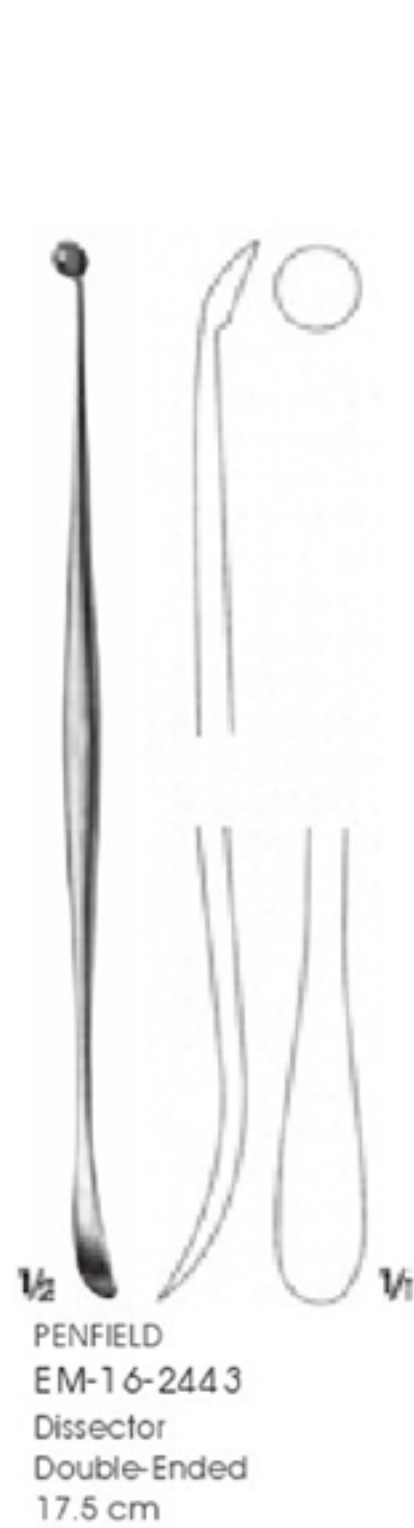
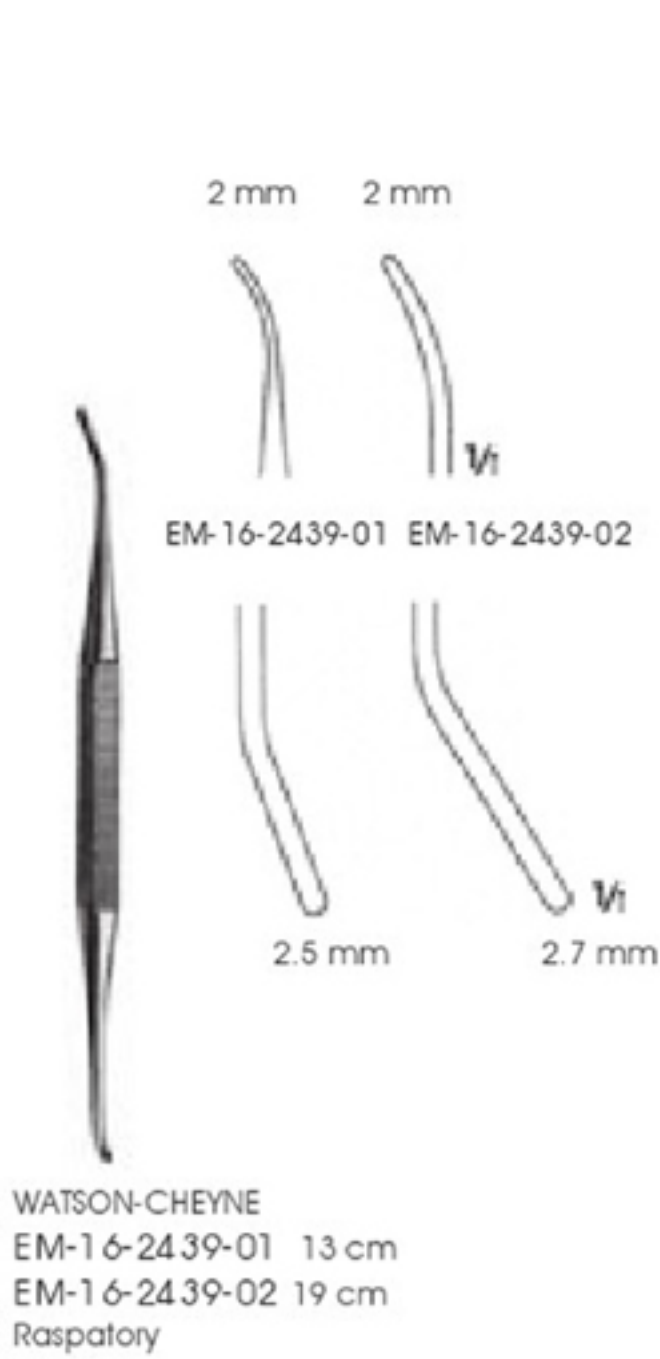



FRAZIER
EM-16-2446-01
Raspatory
15 cm



HOEN
EM-16-2446-02
Raspatory
15 cm



HOEN
EM-16-2446-03
Raspatory
15 cm



FREER
EM-16-2447
Raspatory
20 cm

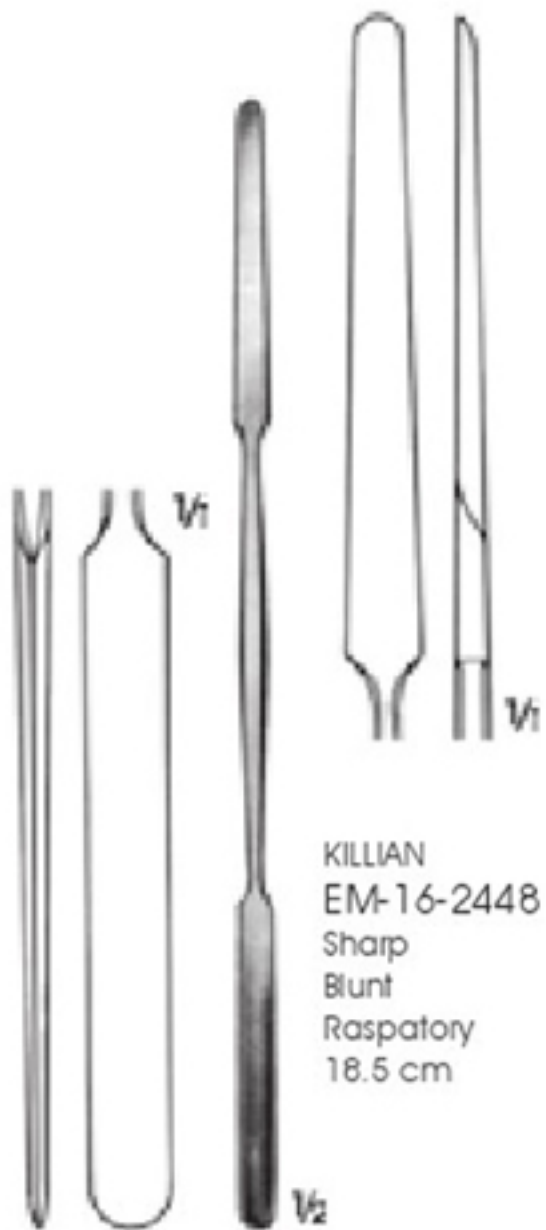

KILLIAN
EM-16-2448
Sharp
Blunt
Raspatory
18.5 cm



O'CONNELL
EM-16-2449
Dissector
Double-Ended
22 cm



MILLIGAN
EM-16-2450
Raspatory
21 cm



WOODSON
EM-16-2451
Raspatory
25 cm

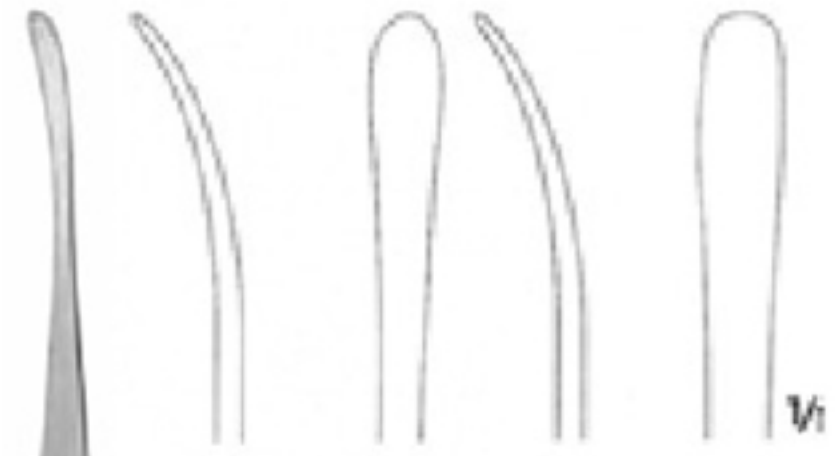

EM-16-2452-01 EM-16-2452-02

1/2 1/1

TÖNNIS
 EM-16-2452-01 - 2452-02
 Dissectors
 24 cm



Künt/Blunt
 4 mm

Semi Sharp
 5 mm

1/2 1/1

HILL
 EM-16-2453
 Raspatory
 Semi-sharp/Blunt
 22 cm

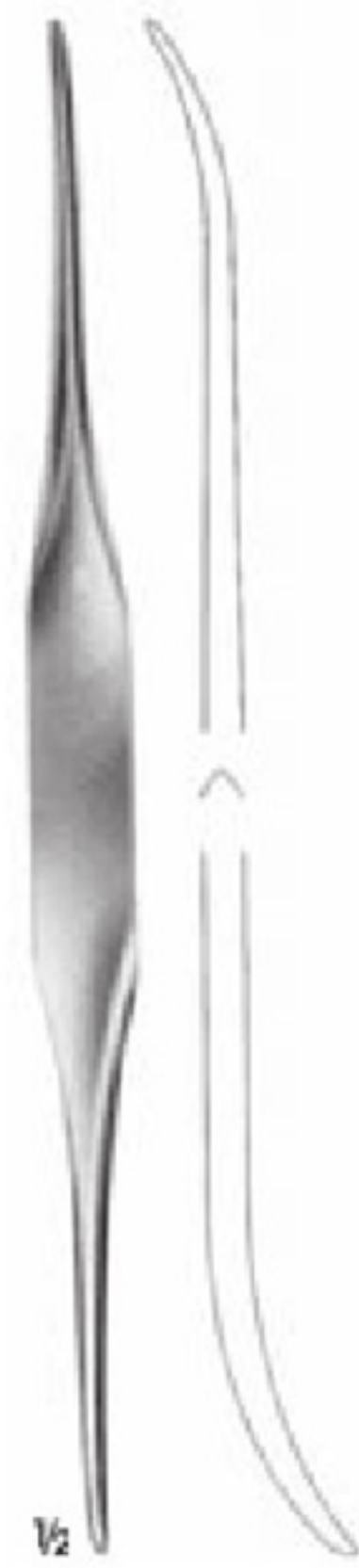

1/2 1/1

TÖENNIS
 EM-16-2454
 Grooved director
 24 cm

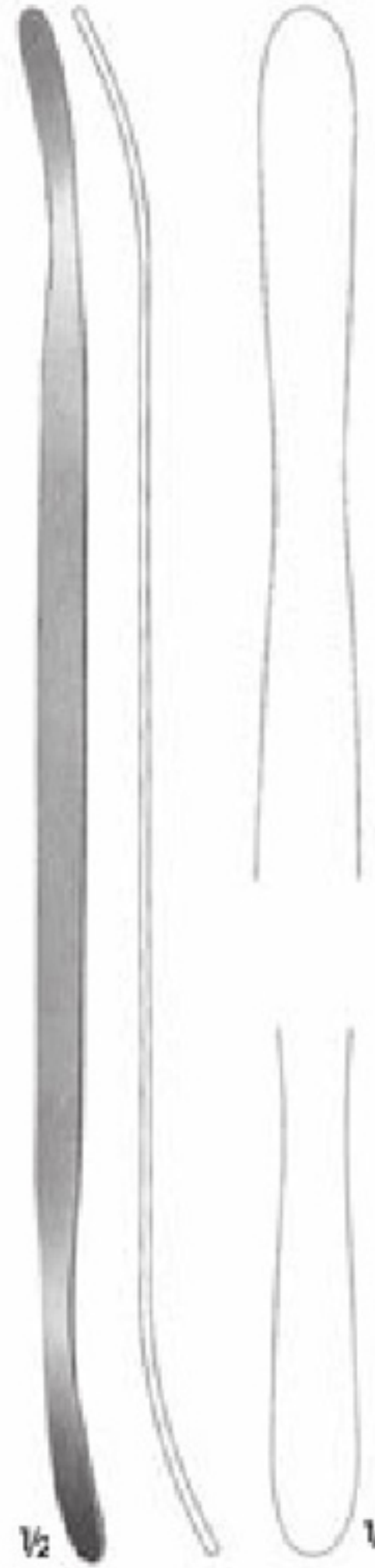

1/2 1/1

PENFIELD
 EM-16-2455 Dissector
 Double-ended, slightly curved
 29 cm



COTTLE
 EM-16-2456
 Sivi/Sharp
 Raspatory
 20 cm



COTTLE
 EM-16-2457
 Sivi/Sharp
 Elevator
 20 cm

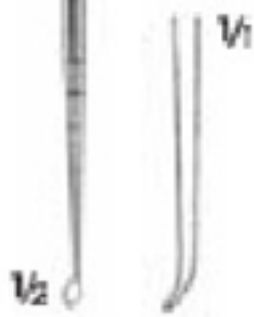

PENNINGTON
 EM-16-2458
 Sivi/Sharp
 Elevator
 21 cm



PIERCE
 EM-16-2459
 Sivi/Sharp
 Raspatory
 21 cm



6 mm

HURD
 EM-16-2460-01
 Dissector
 21.5 cm



10 mm

HURD
 EM-16-2460-02
 Dissector
 21.5 cm



12 mm

HENKE
 EM-16-2461-01
 Dissector
 23.5 cm



17 mm

HENKE
 EM-16-2461-02
 Dissector
 23.5 cm



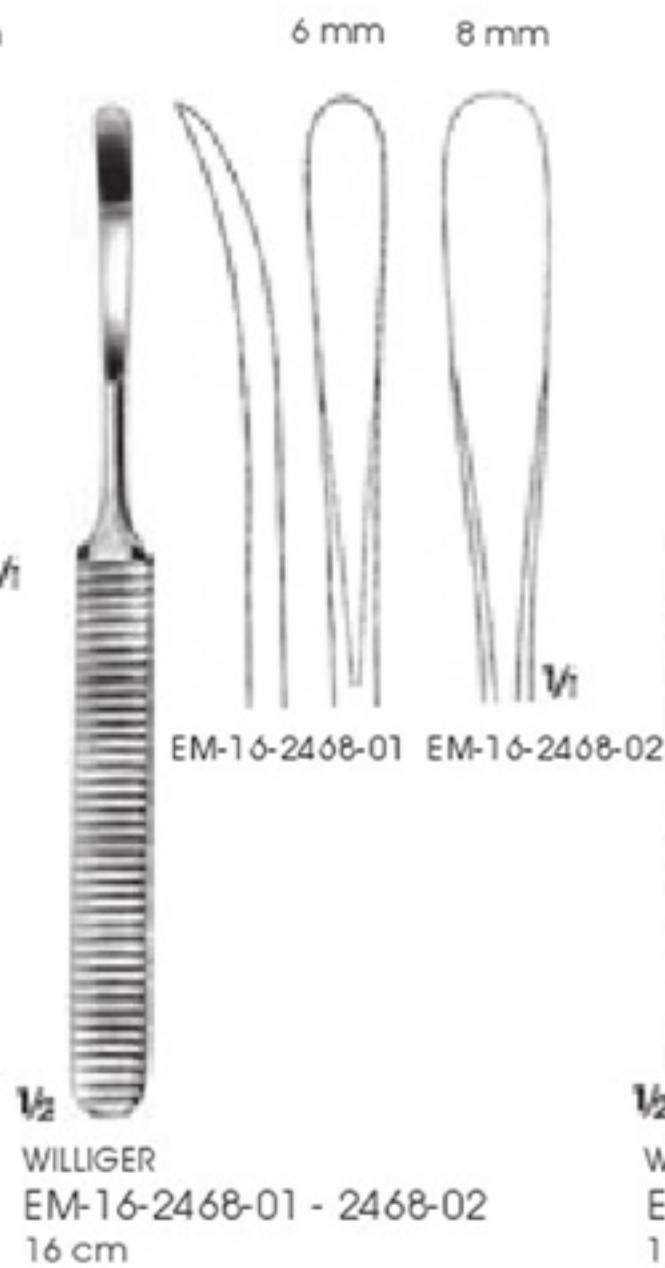
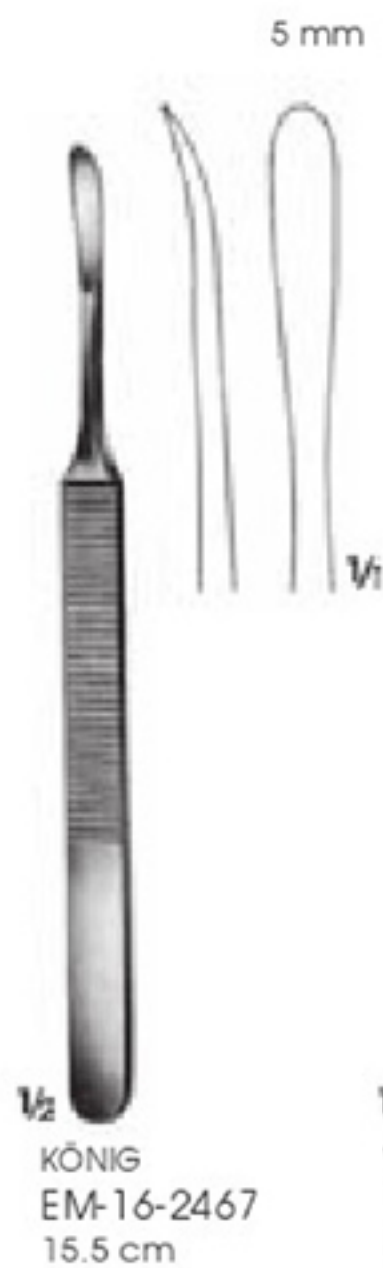
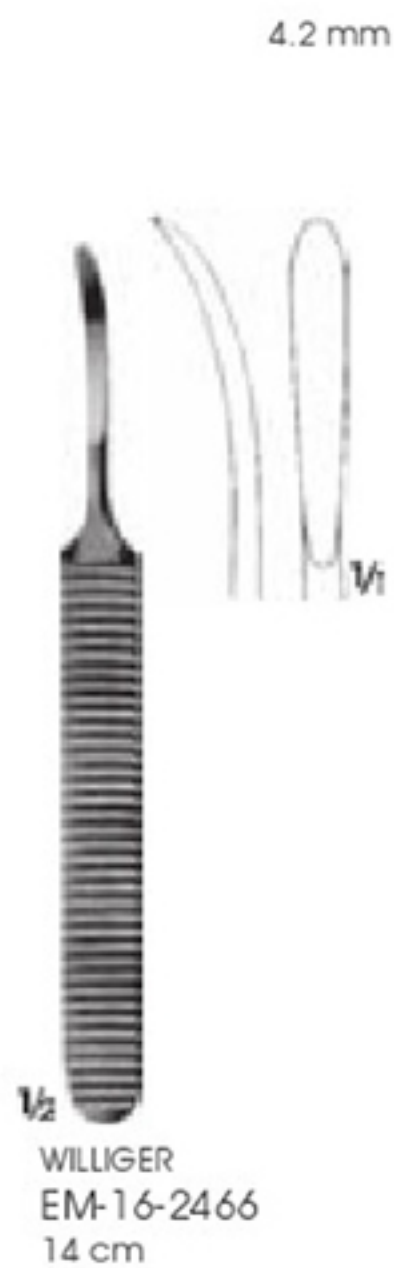
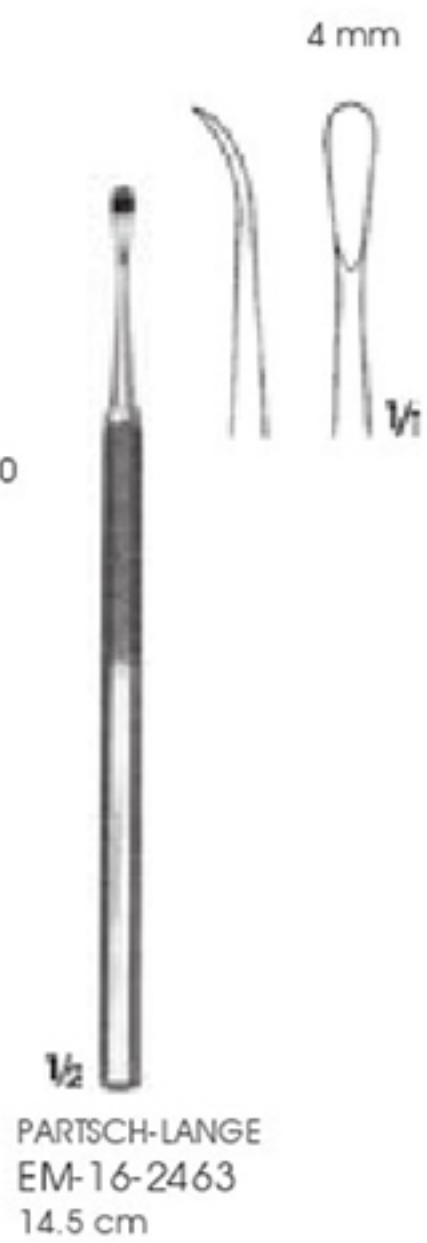
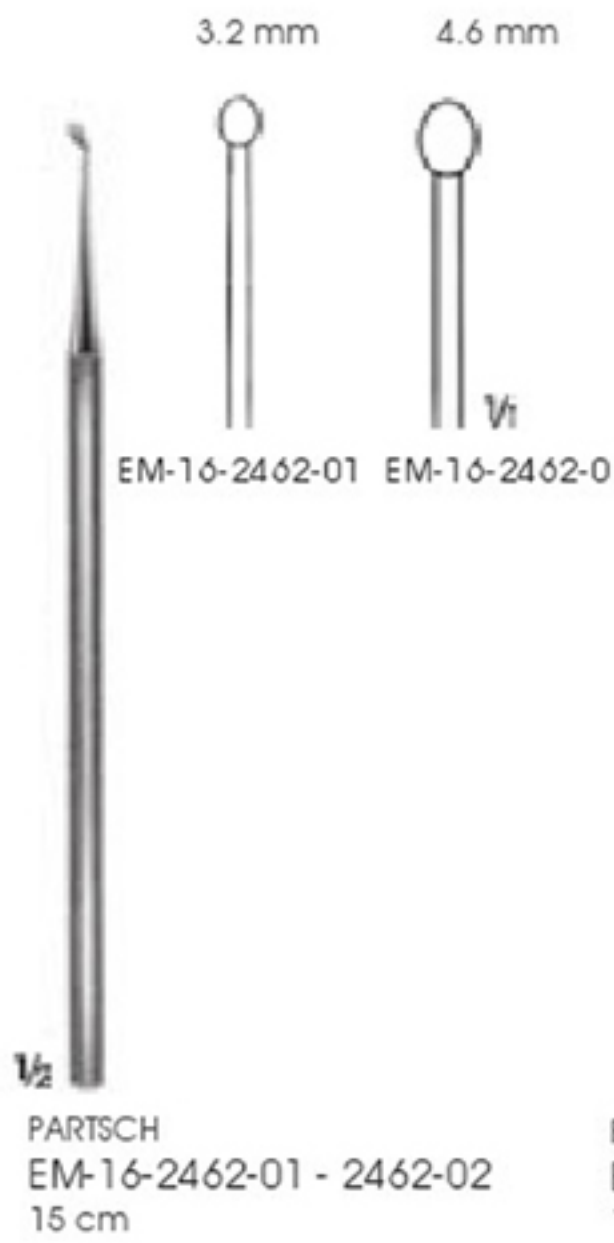

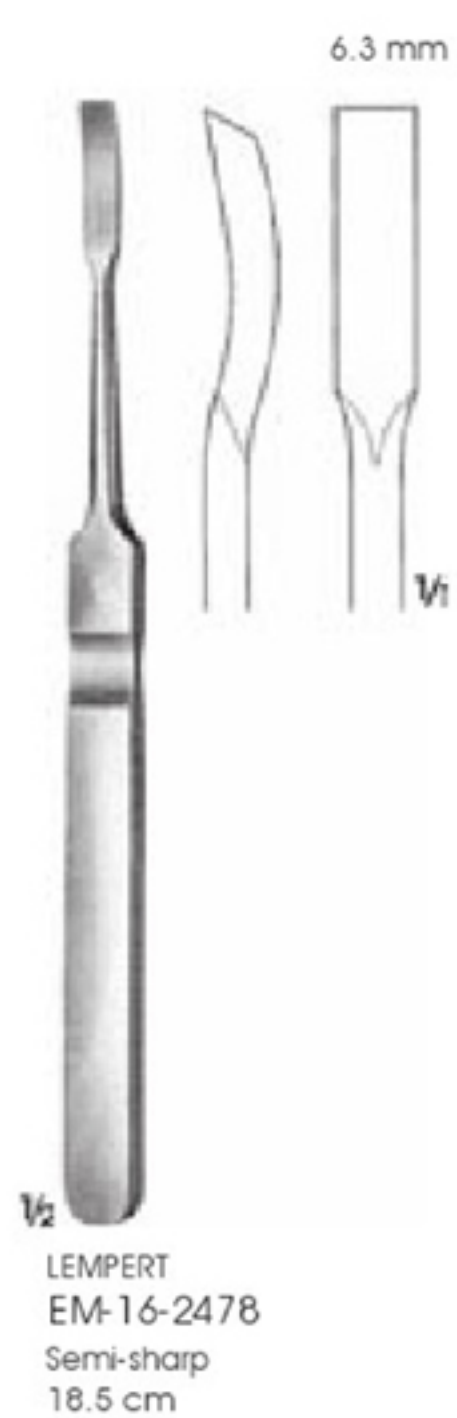
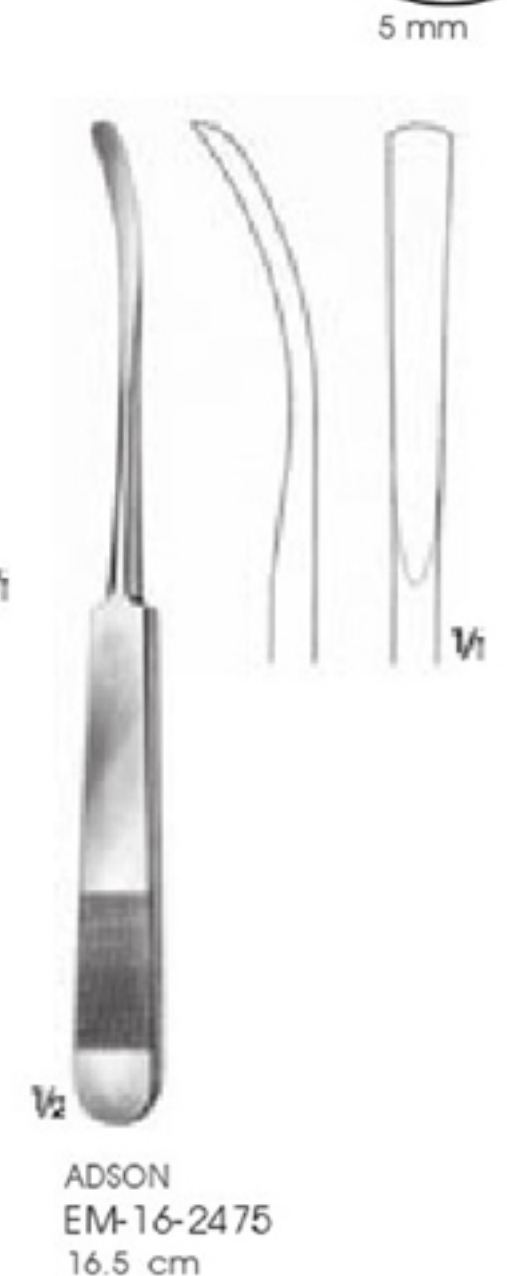
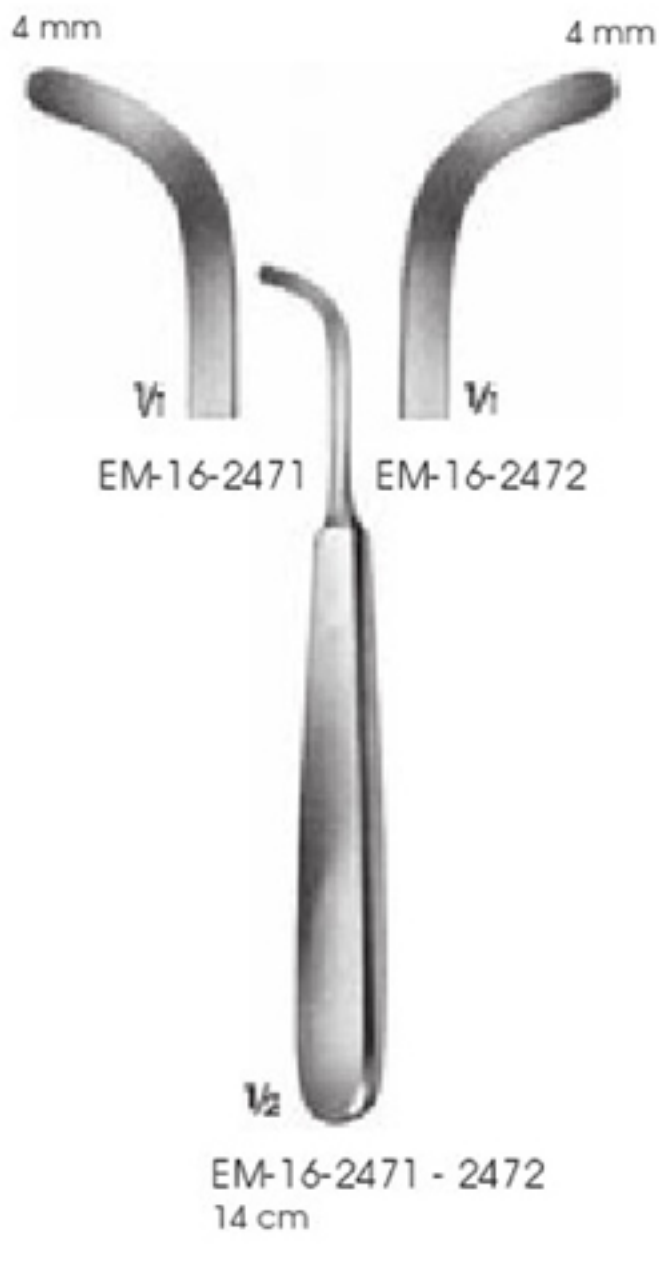

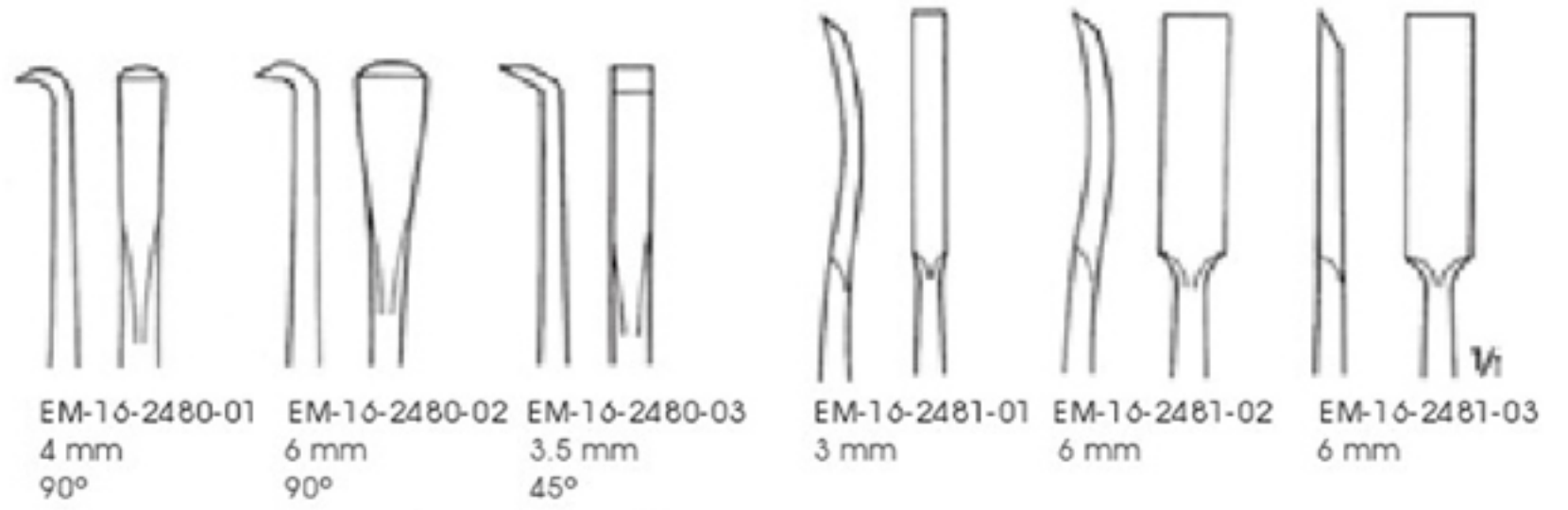

MANNERFELT
EM-16-2480-01 - 2483-03
15.5 cm

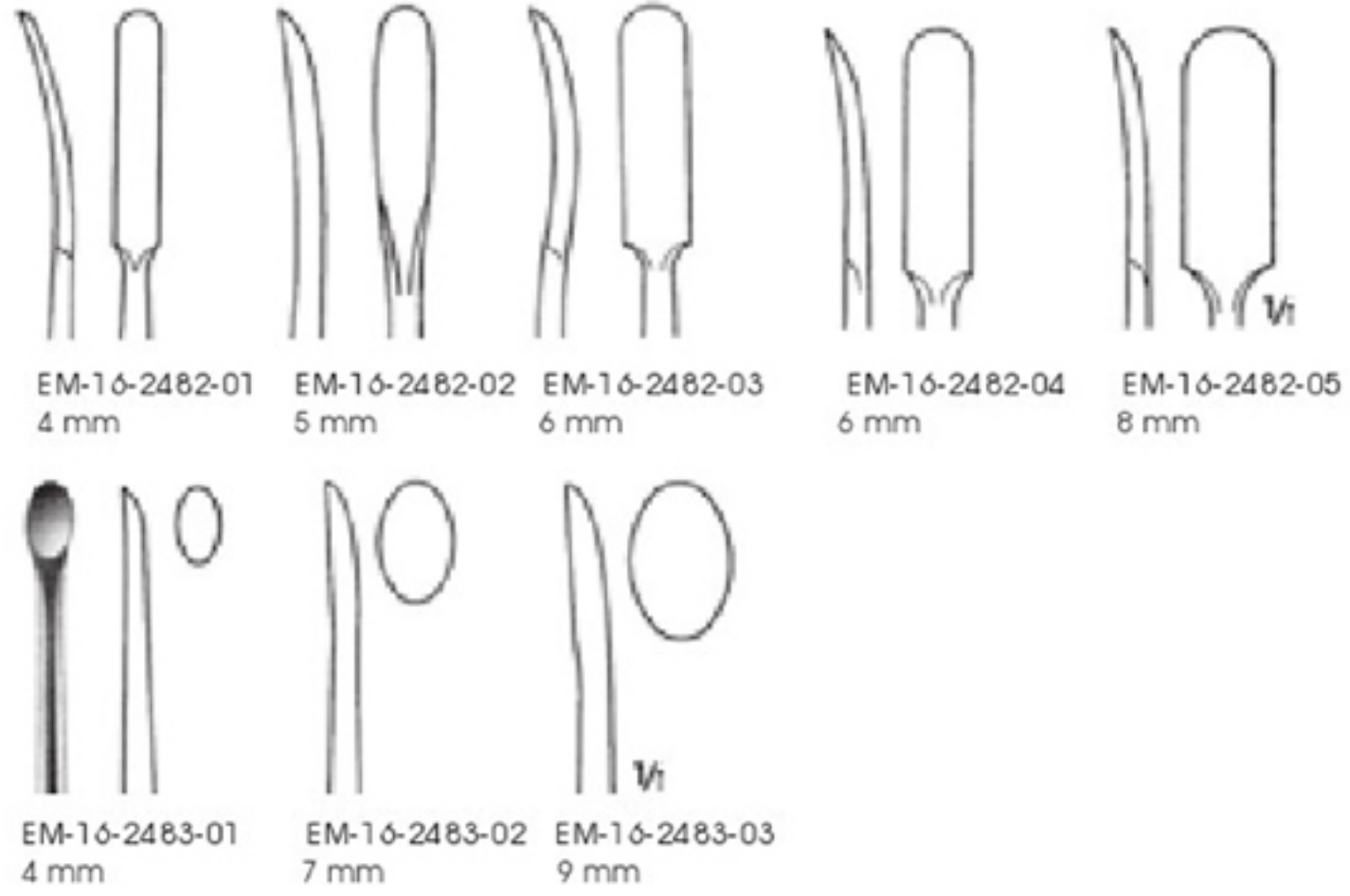

PAULSEN
EM-16-2484-01 - 2484-02
20.5 cm



PAULSEN
EM-16-2485-01 - 2485-03
20.5 cm

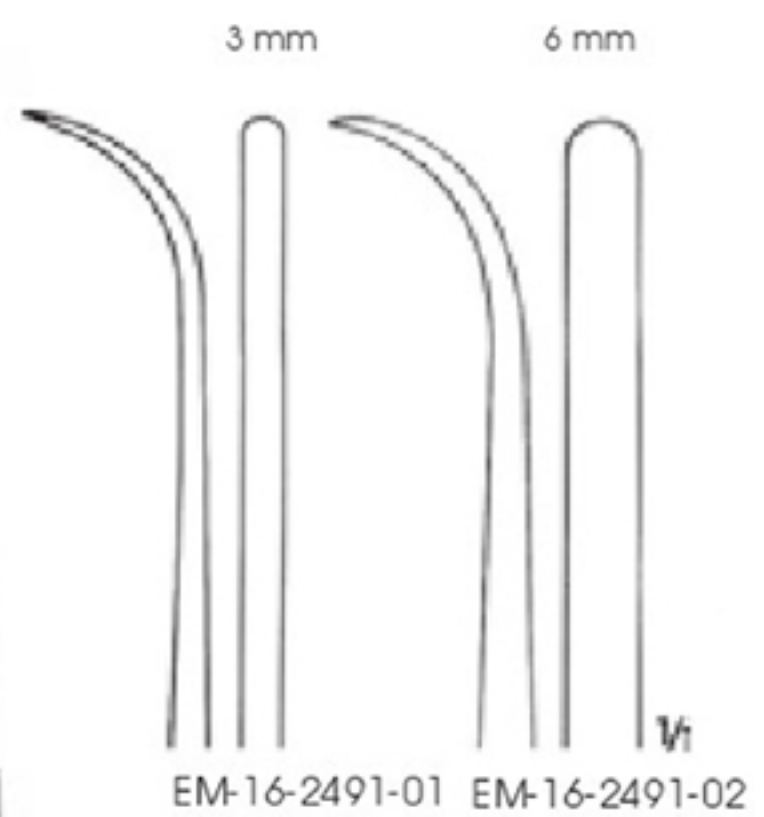
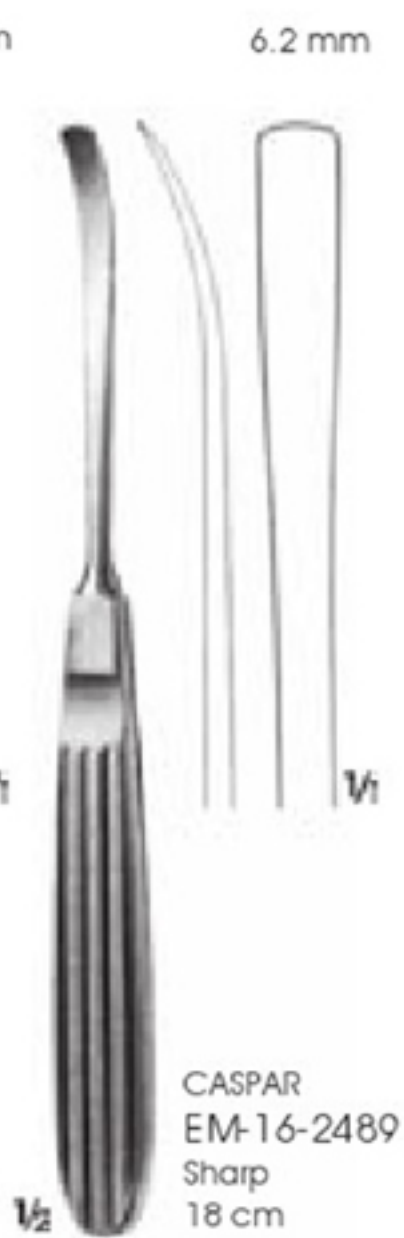
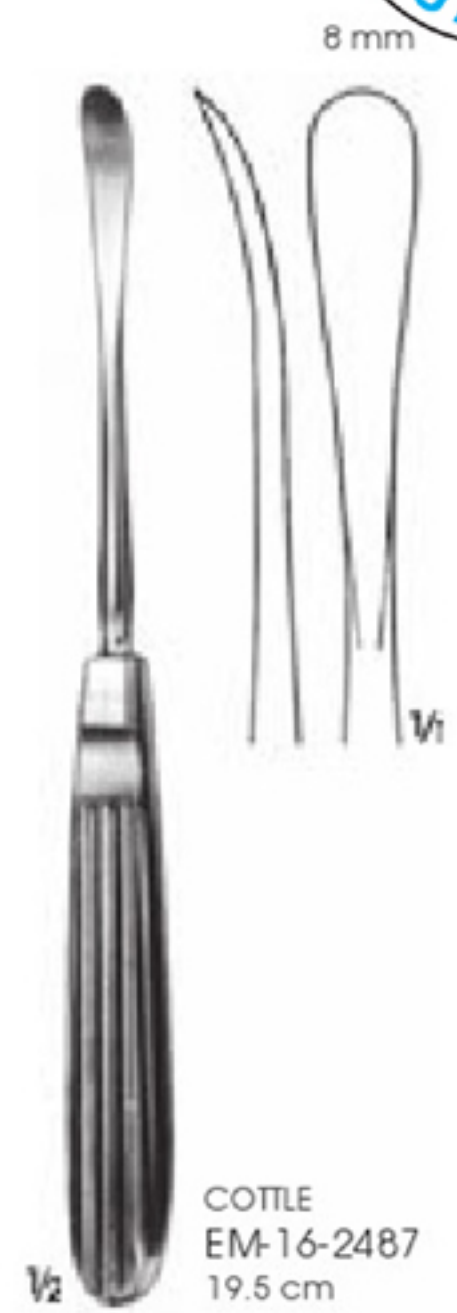
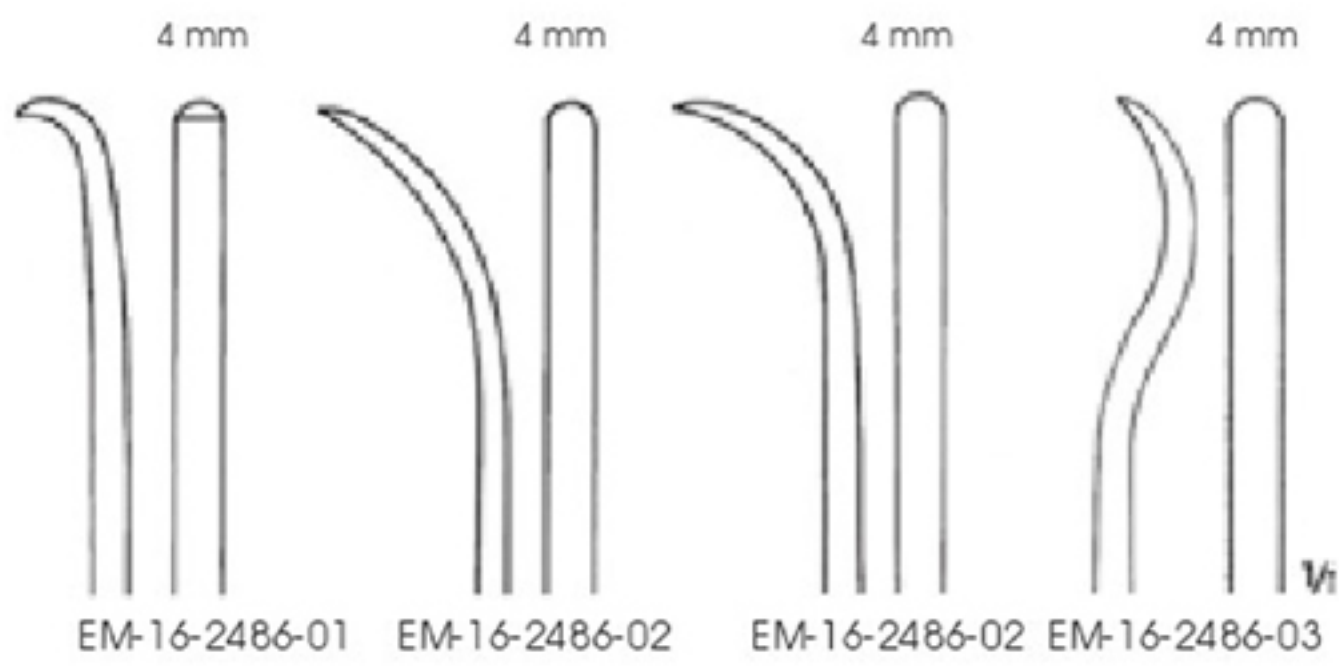

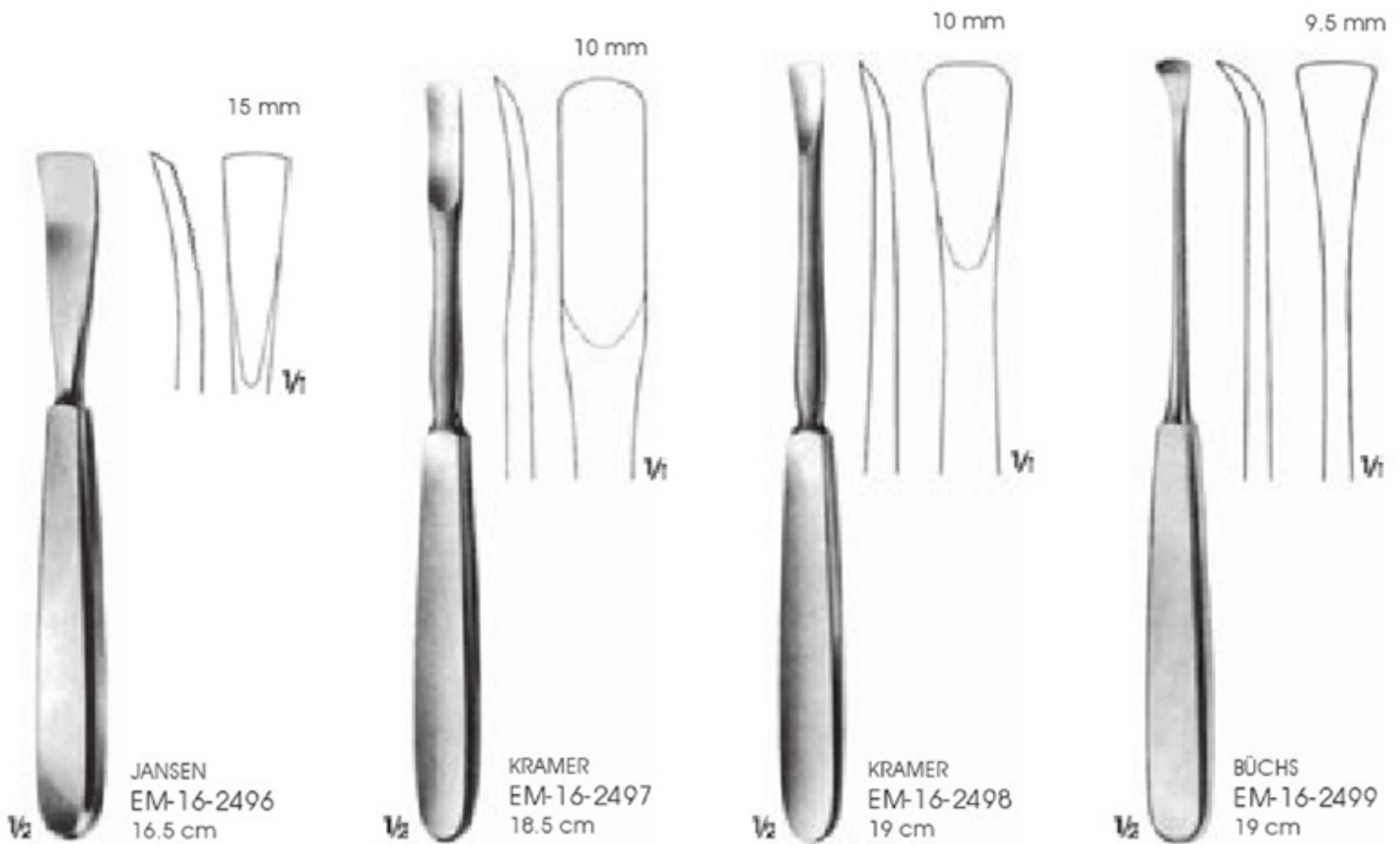
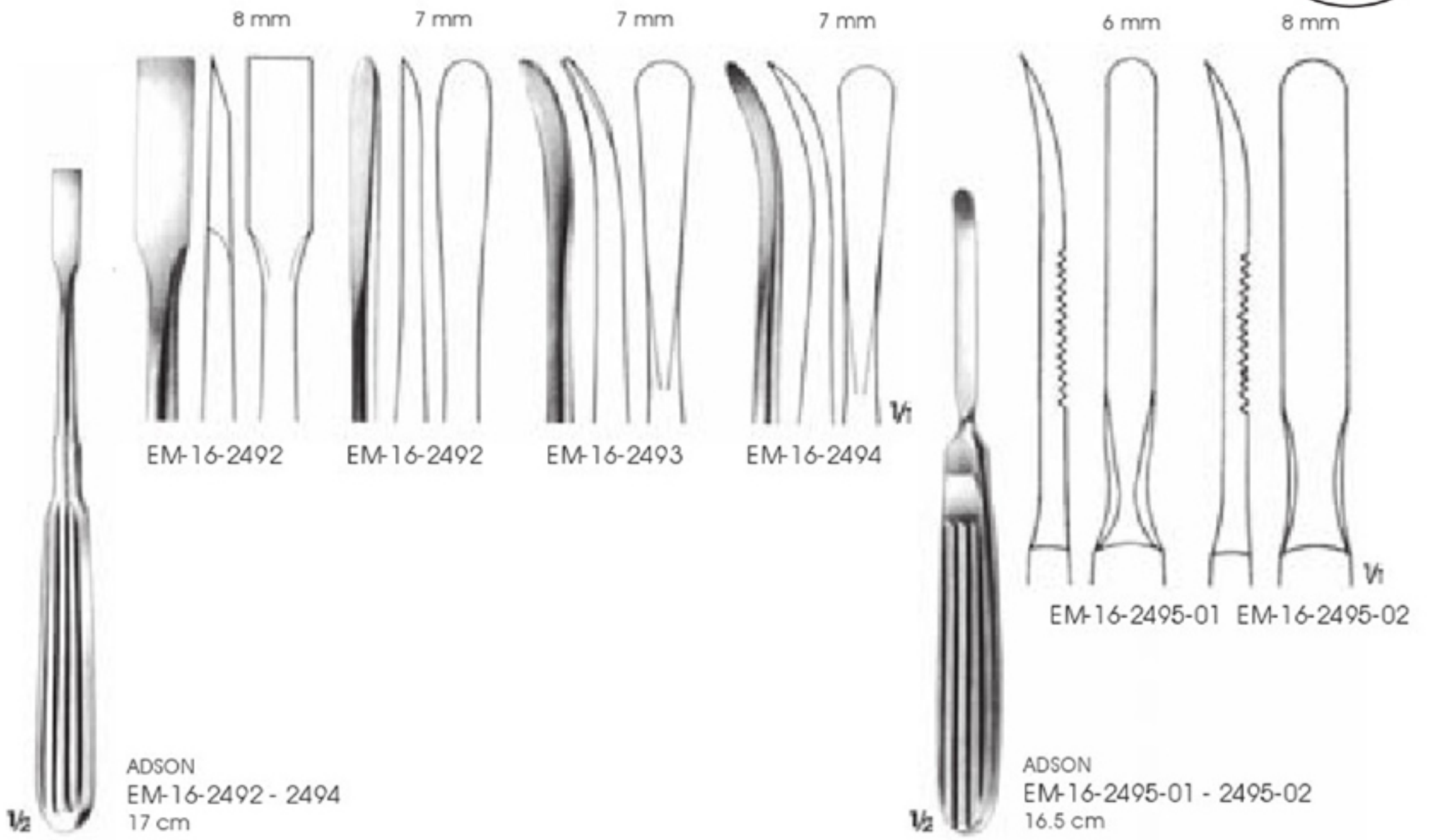

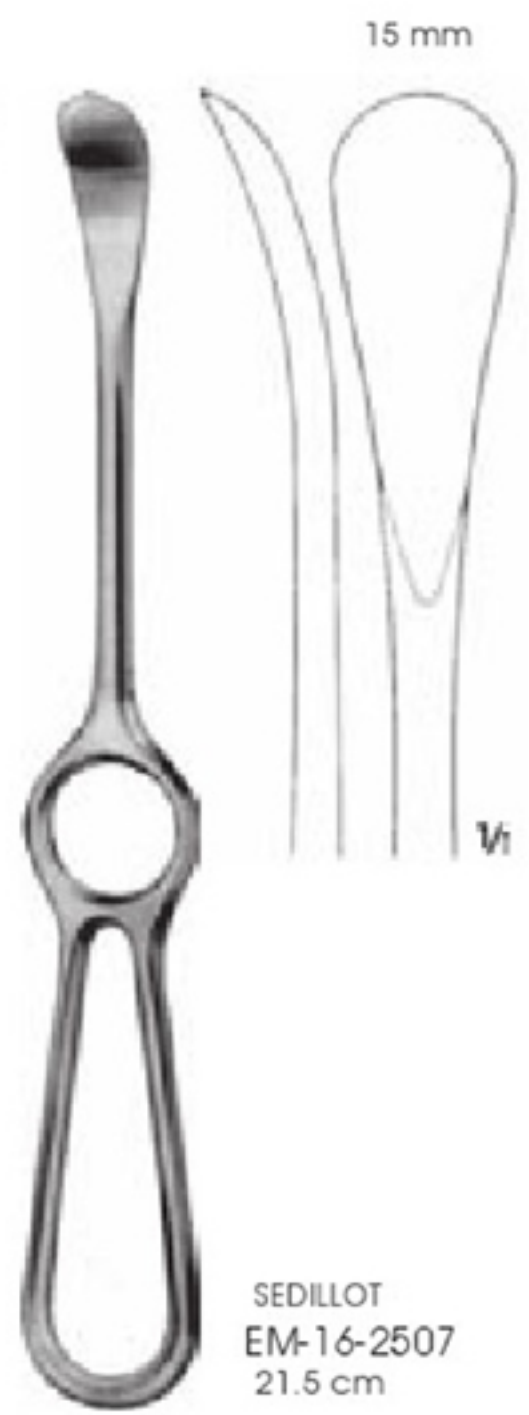
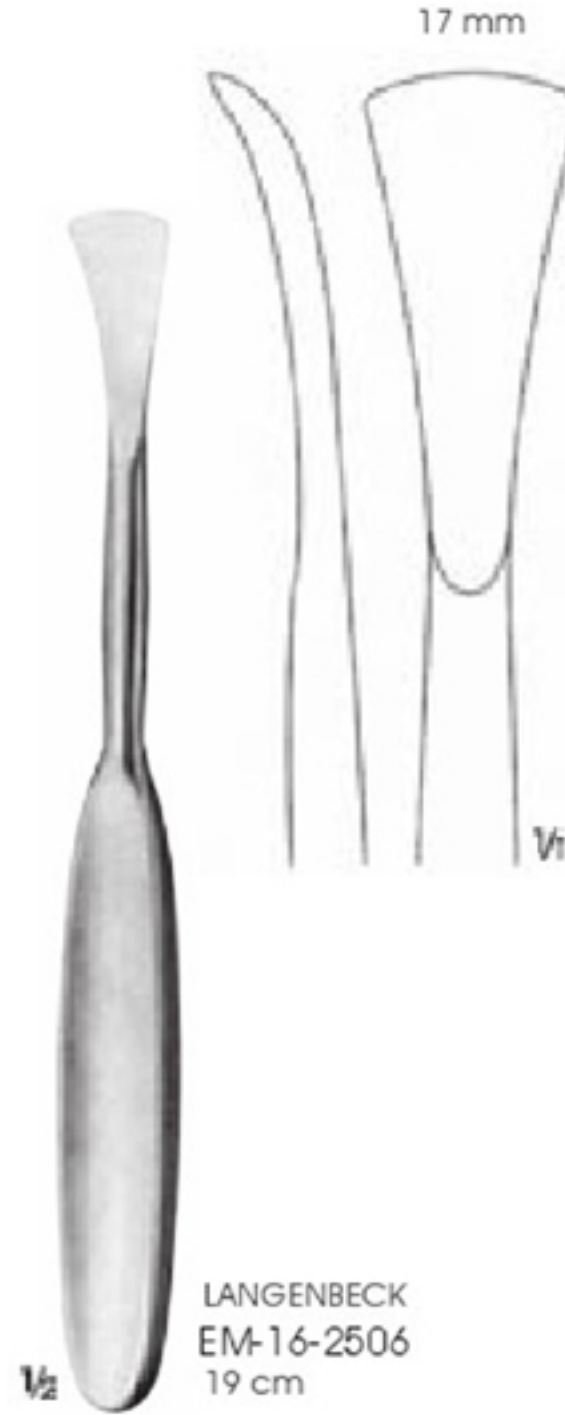
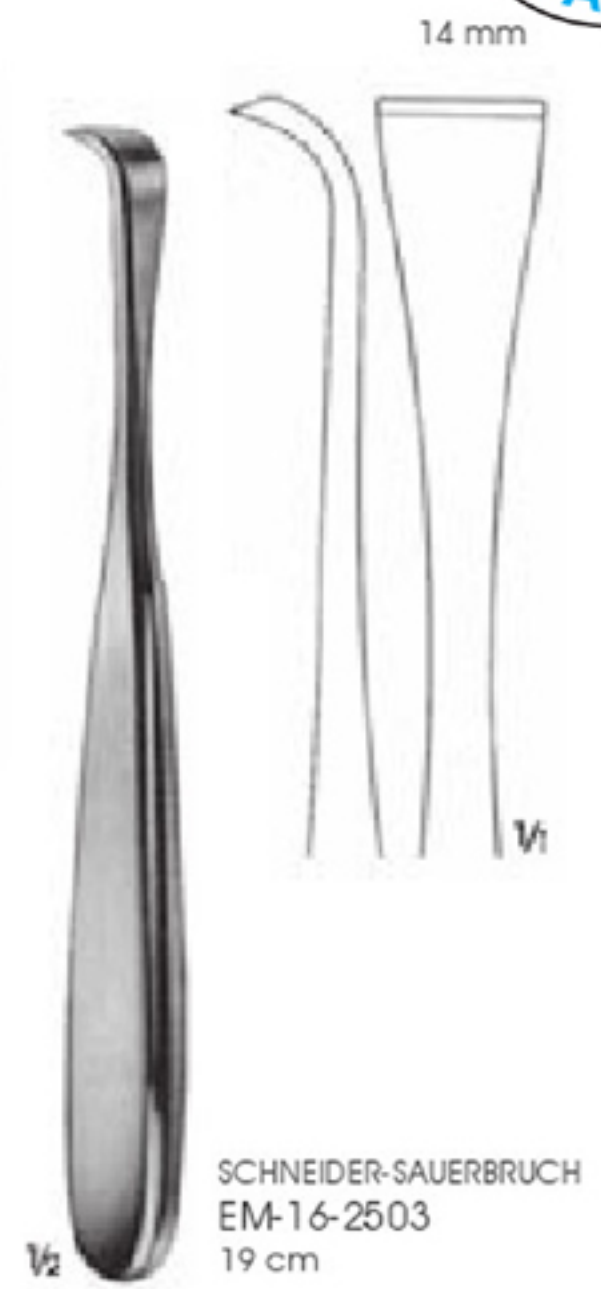
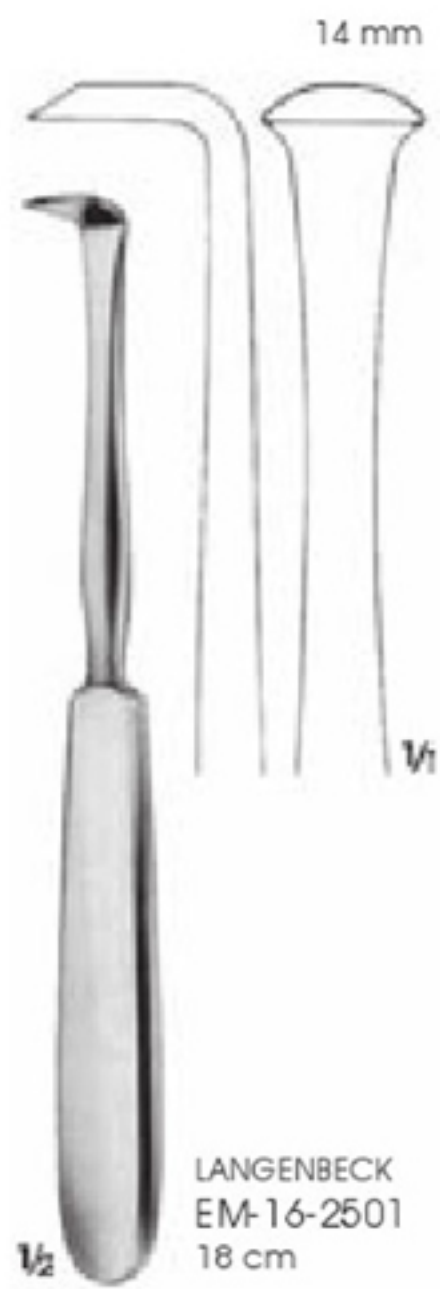
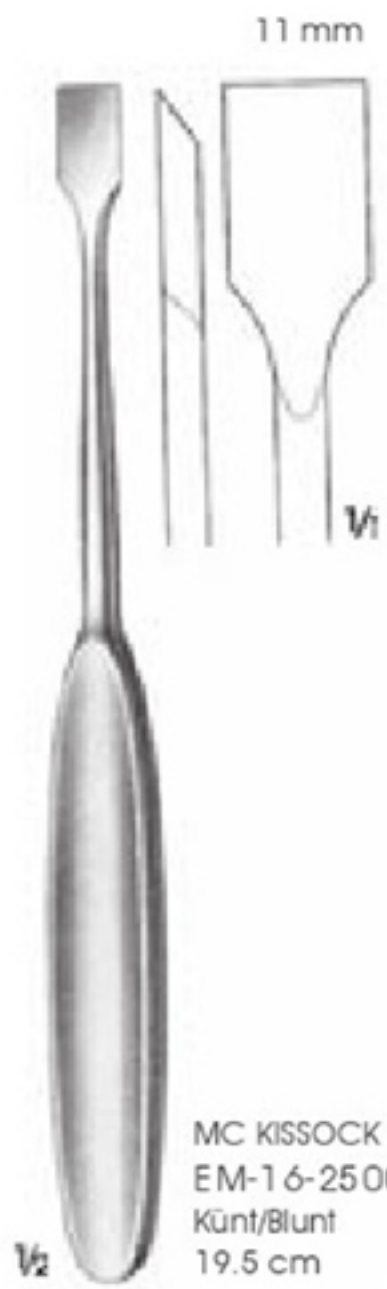

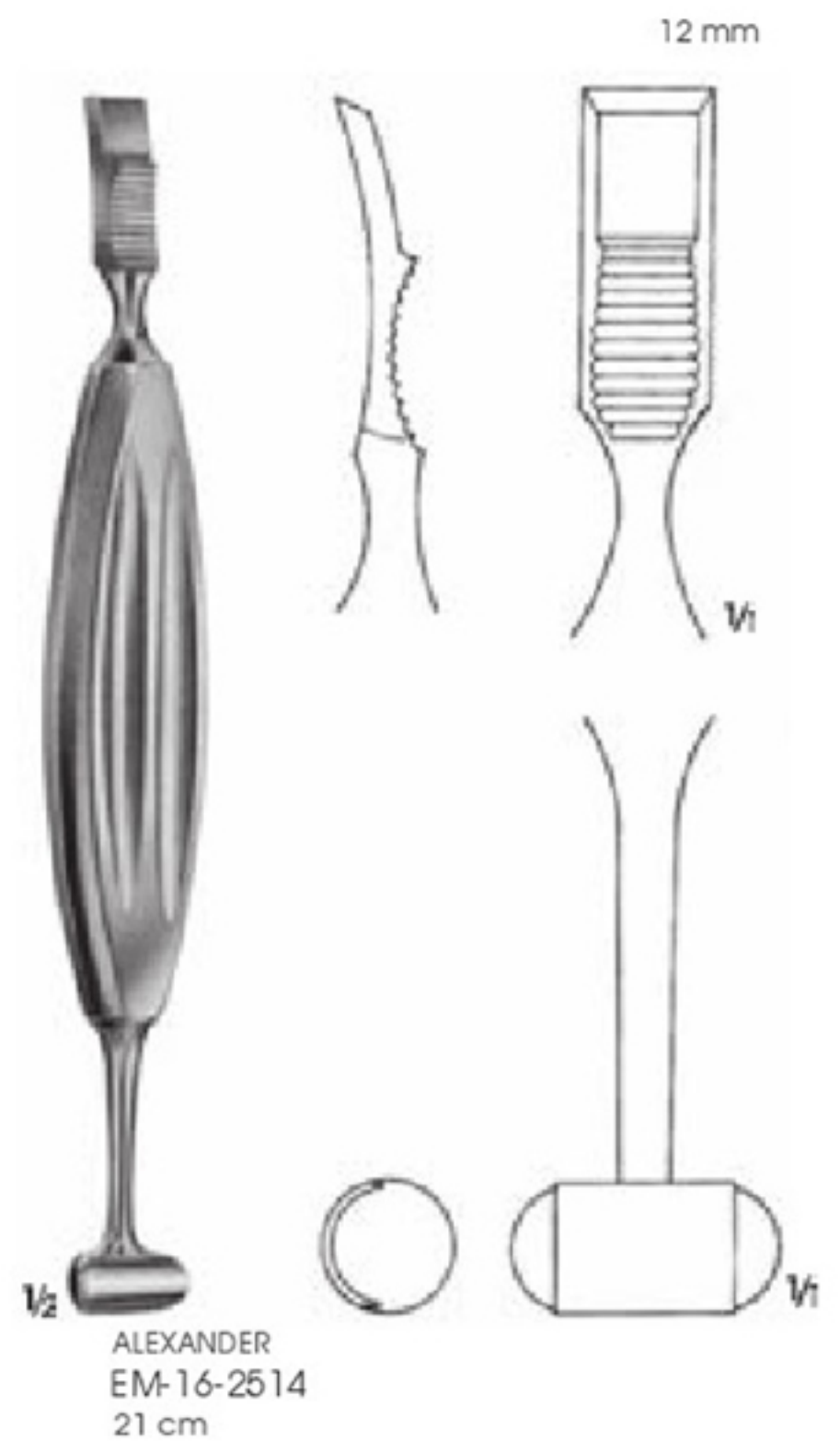
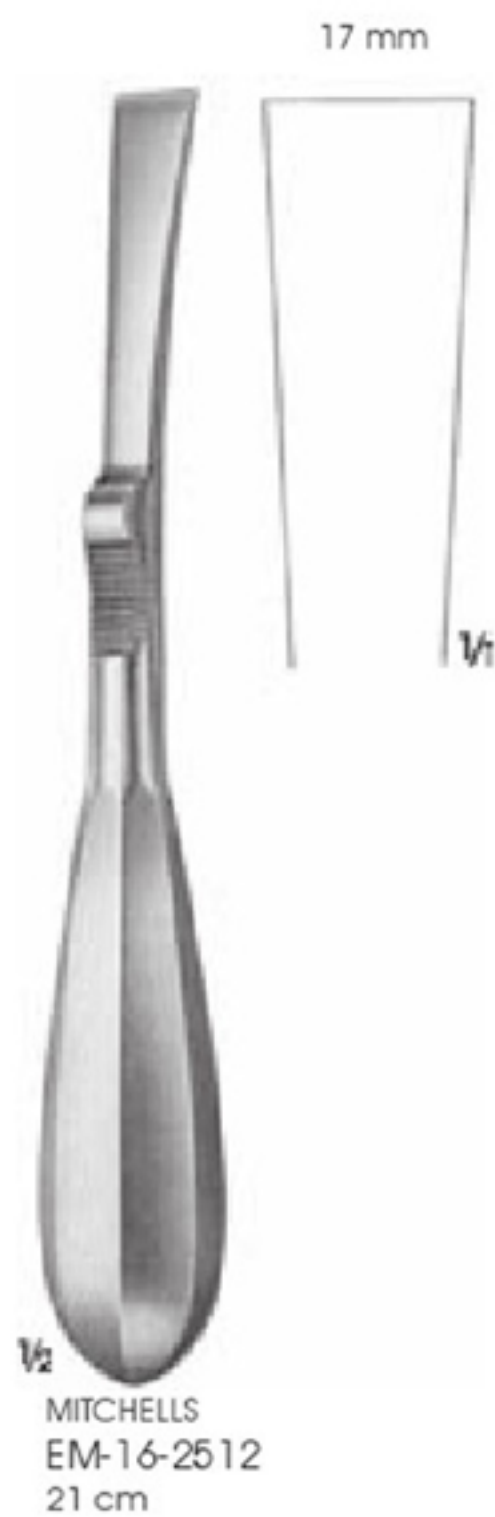
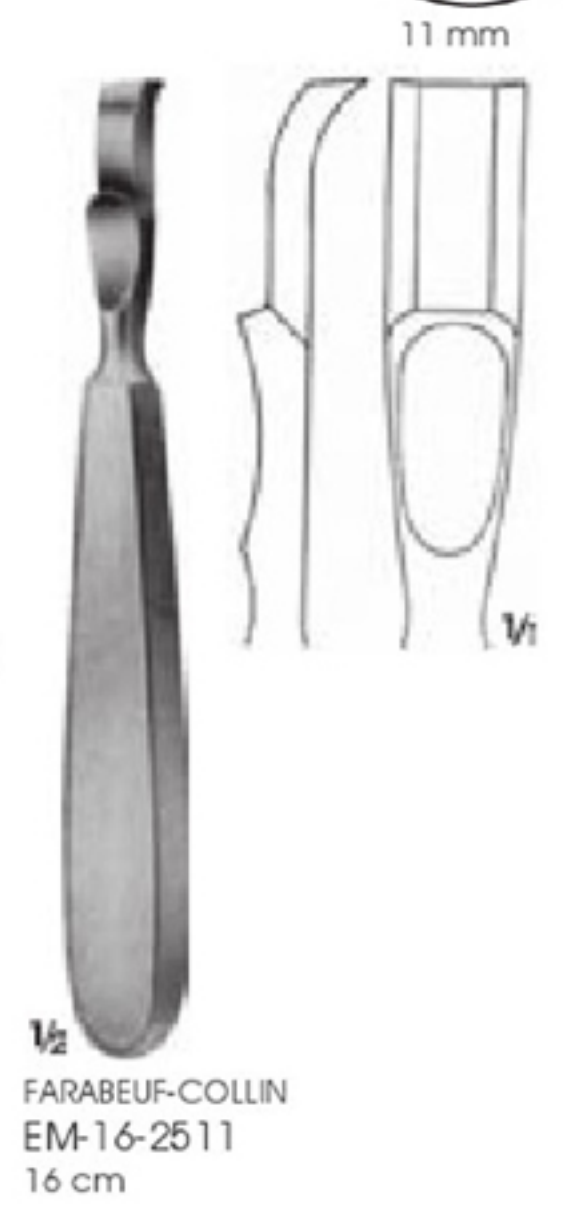
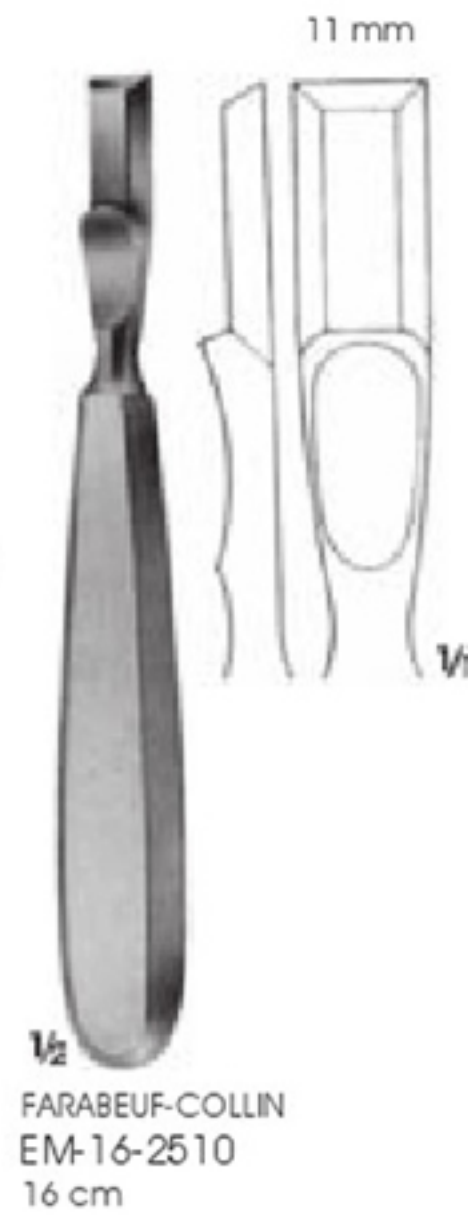
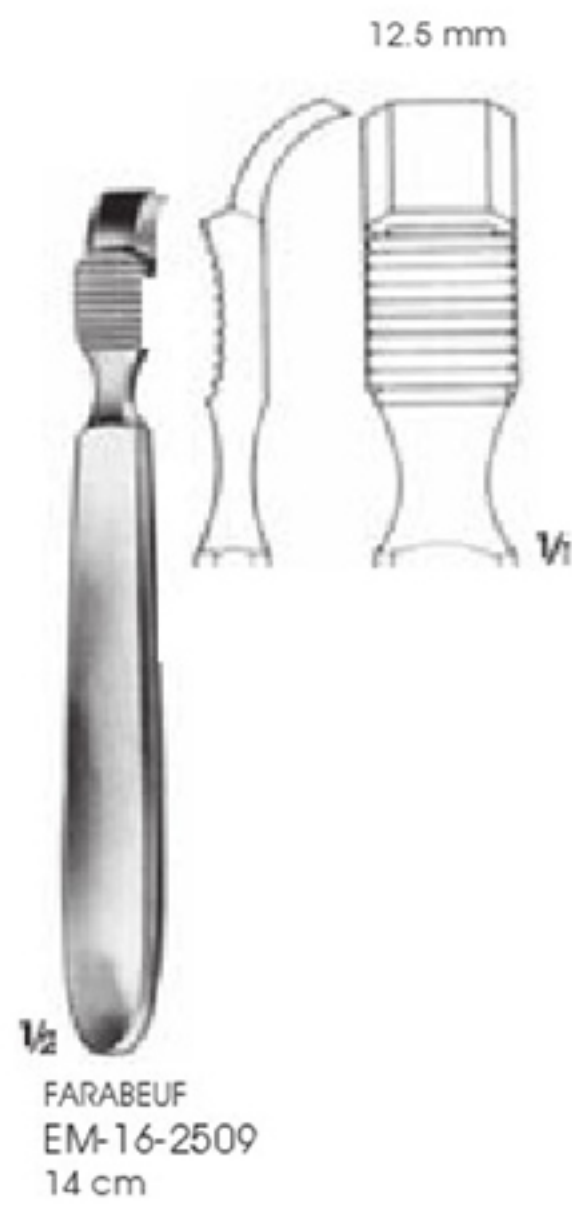
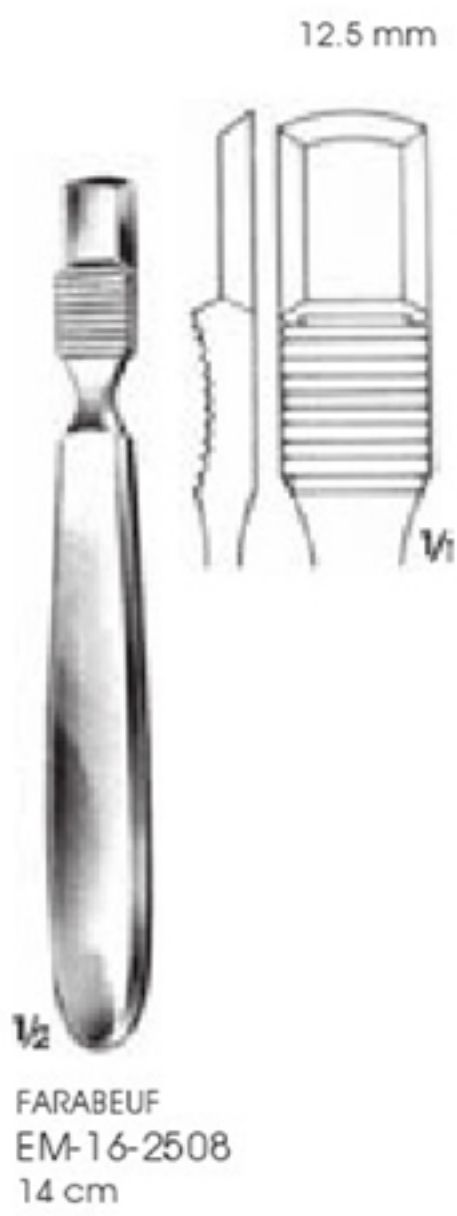

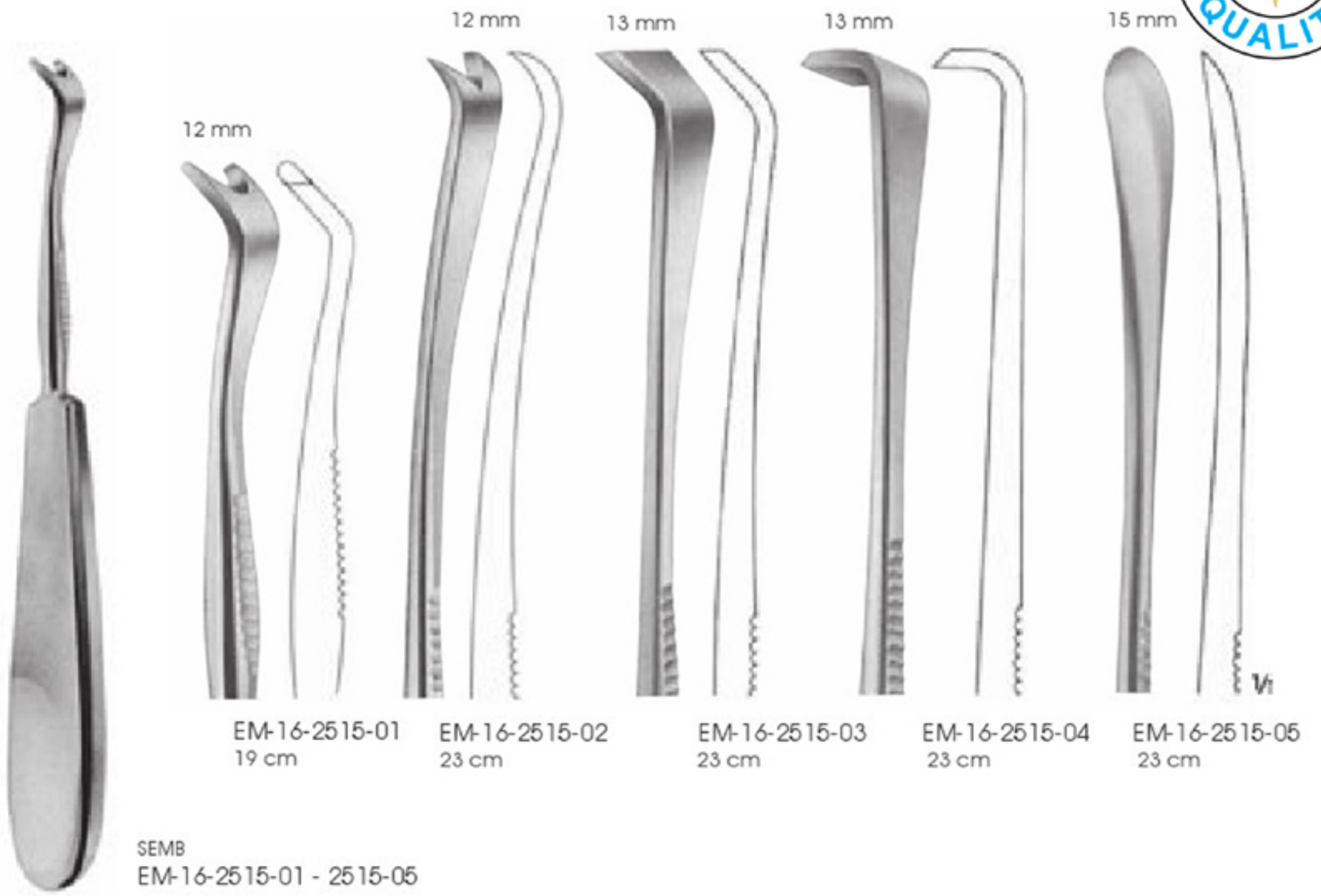

SEMB
EM-16-2515-01 - 2515-05

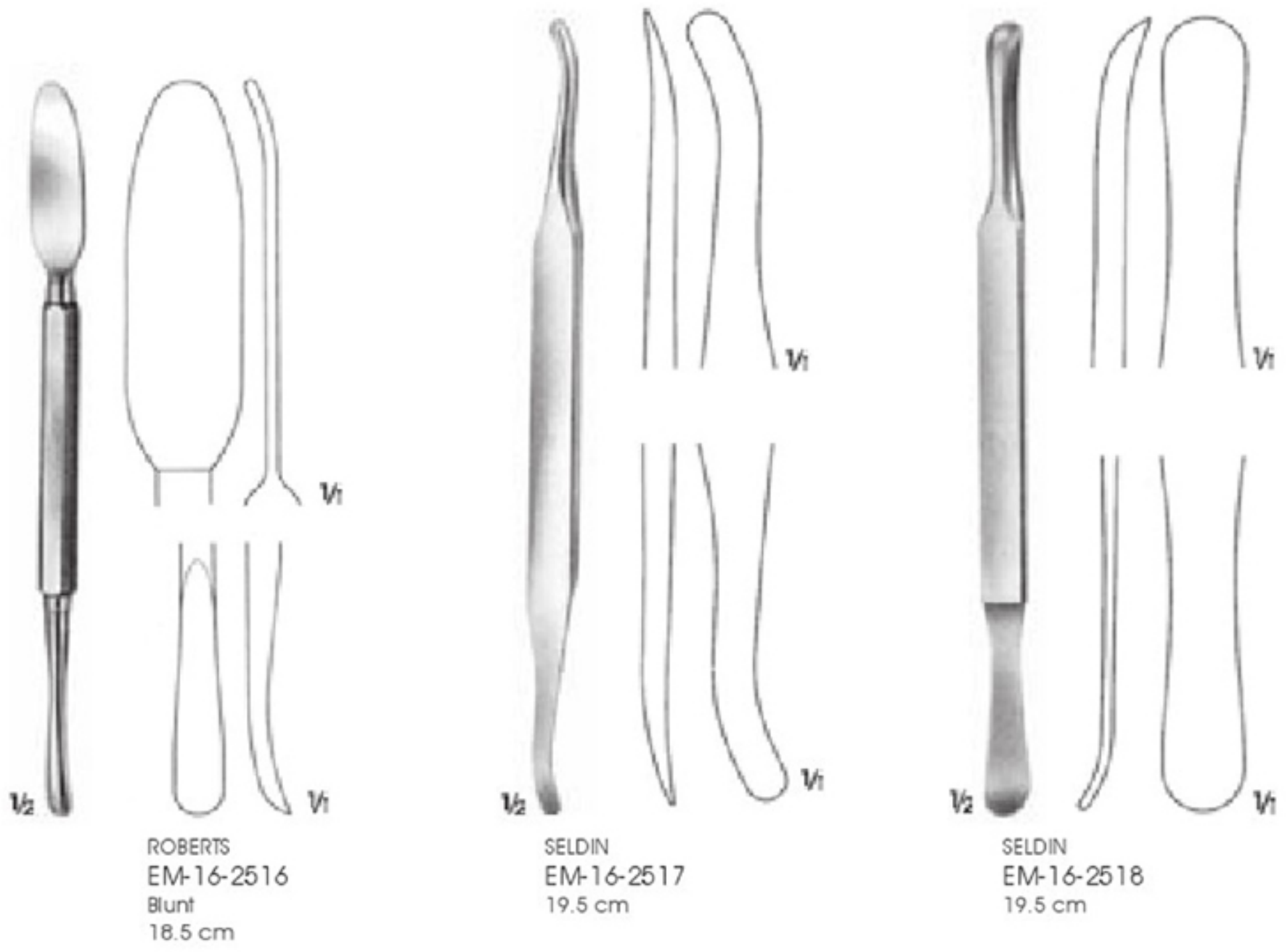

ROBERTS
EM-16-2516
Blunt
18.5 cm

SELDIN
EM-16-2517
19.5 cm

SELDIN
EM-16-2518
19.5 cm

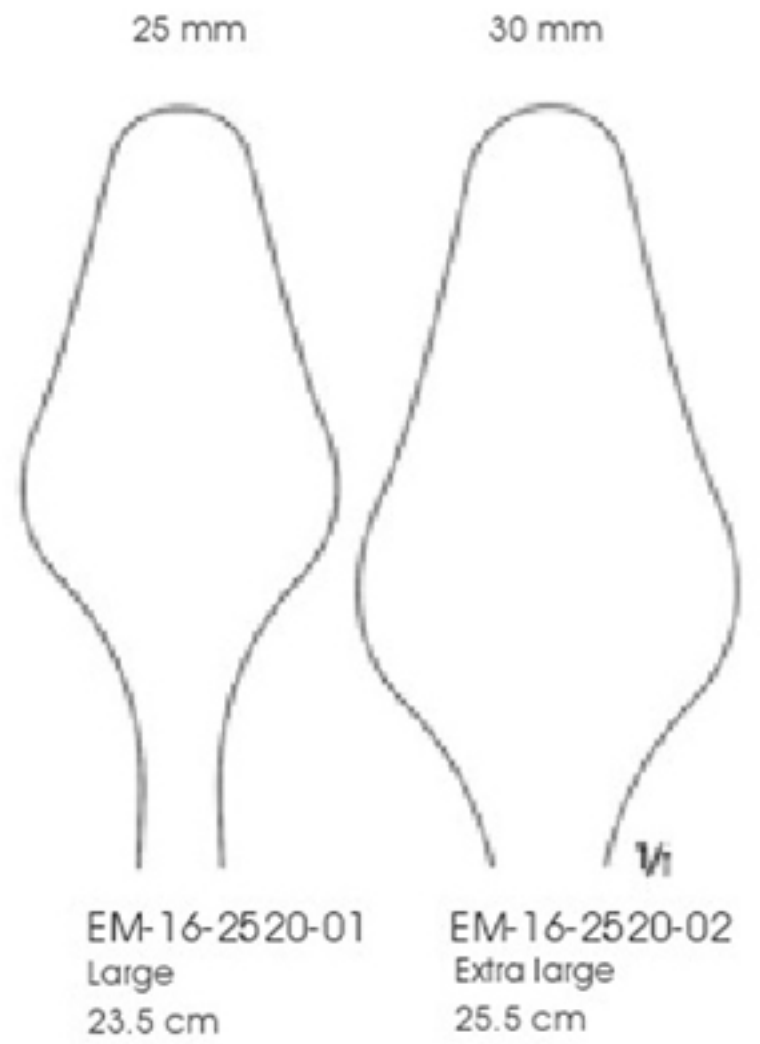
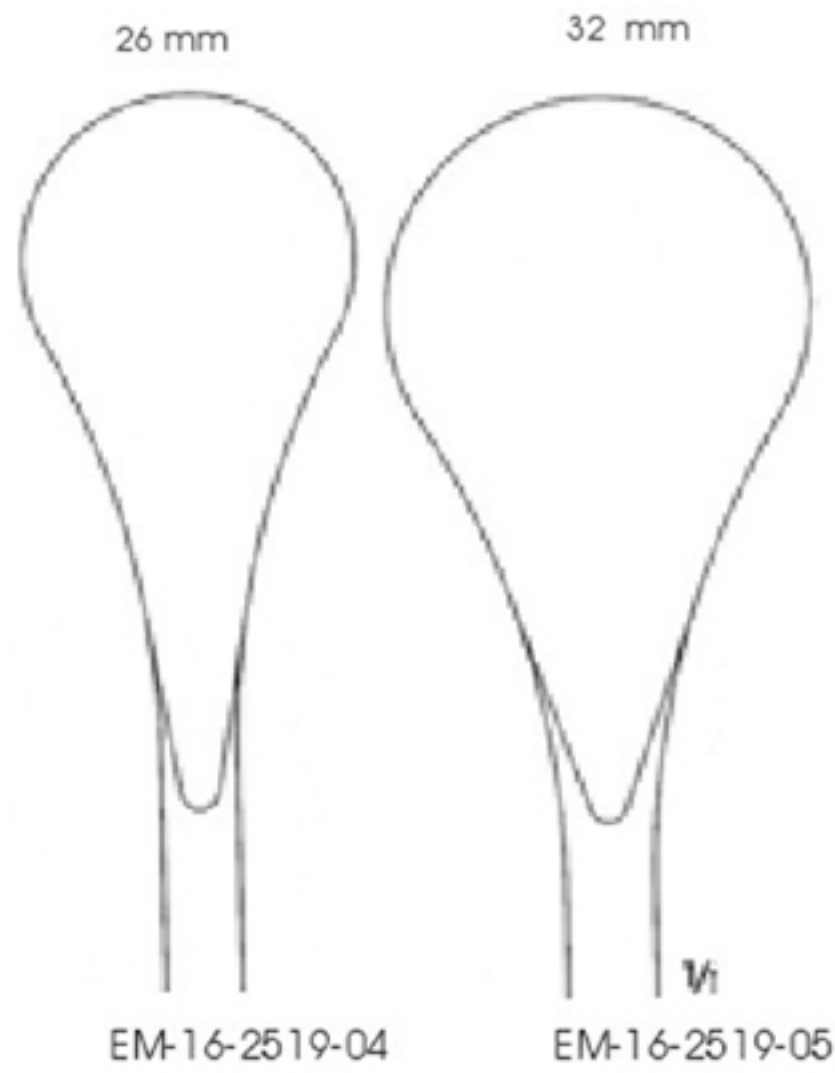
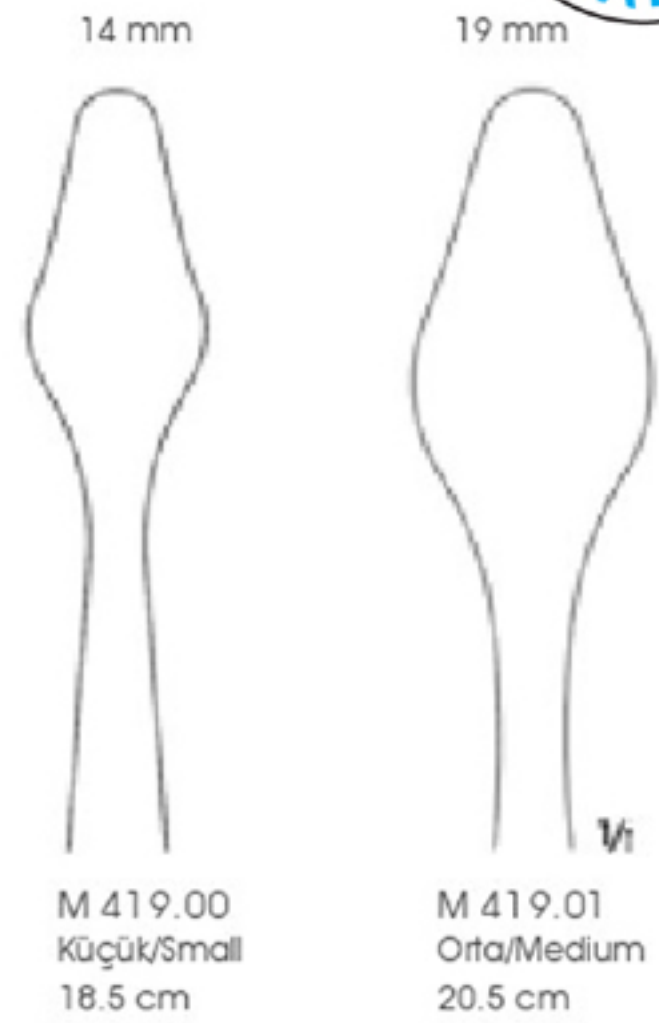
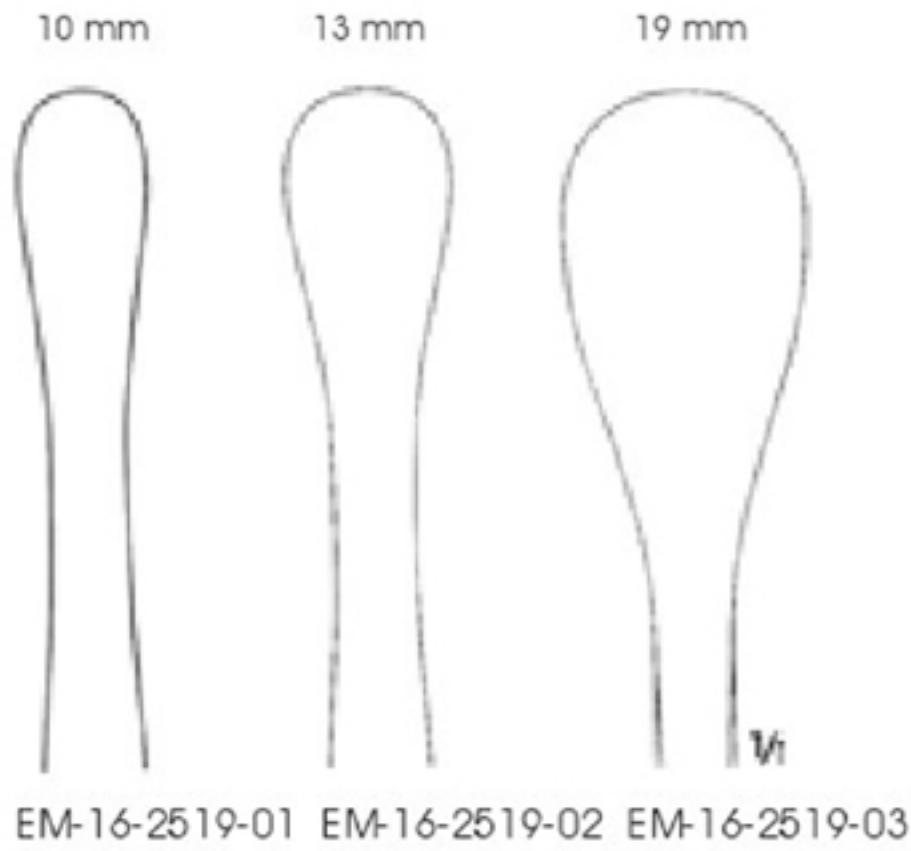

COBB
EM-16-2519-01 - 2519-05
Raspa/Raspatory
28 cm

CHANDLER
EM-16-2520-01 - 2520-02
Elevatör/Elevators

19 mm



EM-16-2522-03

8 mm



EM-16-2523-03

13 mm



EM-16-2522-02

6 mm



EM-16-2523-02

10 mm



EM-16-2522-01

4 mm



EM-16-2523-01



KEY
EM-16-2521-01 - 2521-05

	Wid th	Uzunluk
EM-16-2521-01	6 mm	18 cm
EM-16-2521-02	10 mm	19 cm
EM-16-2521-03	13 mm	19 cm
EM-16-2521-04	19 mm	20 cm
EM-16-2521-05	25 mm	21 cm



COBB
EM-16-2522-01 - 2522-03
24 cm



COBB
EM-16-2523-01 - 2523-03
27 cm

Can be sterilized in a steam sterilizer up to 143°

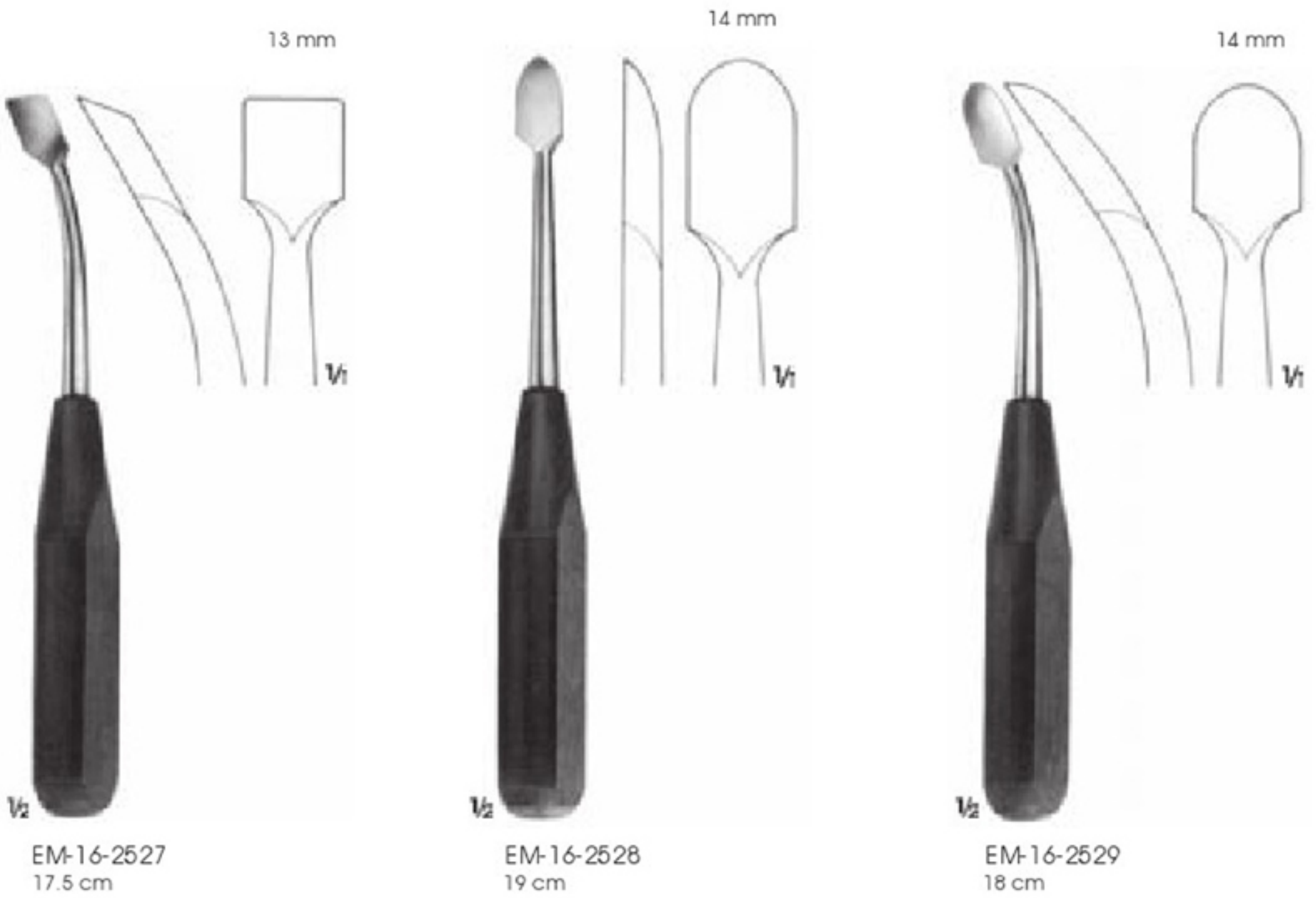
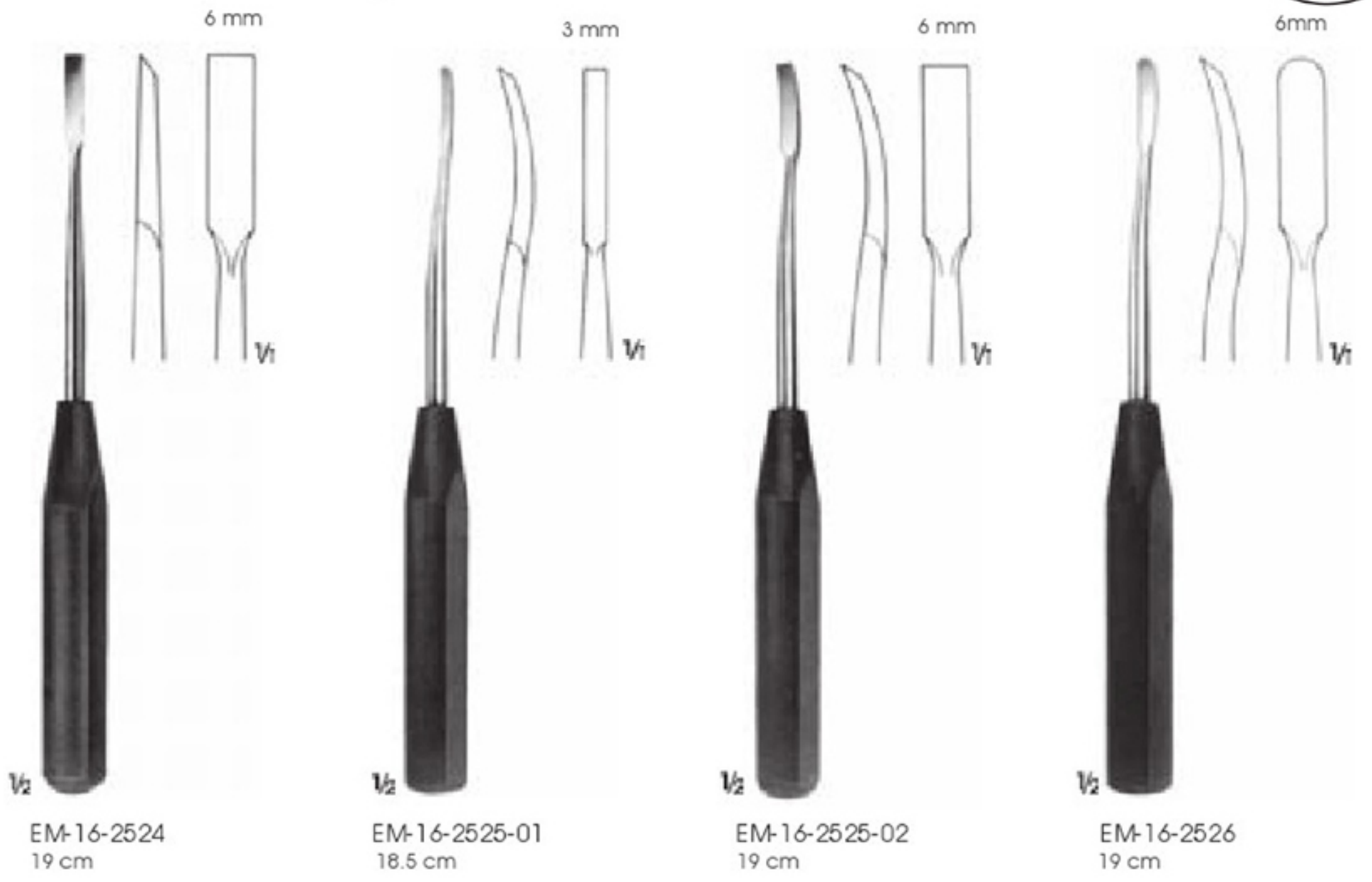

Can be sterilized in a steam sterilizer up to 143°

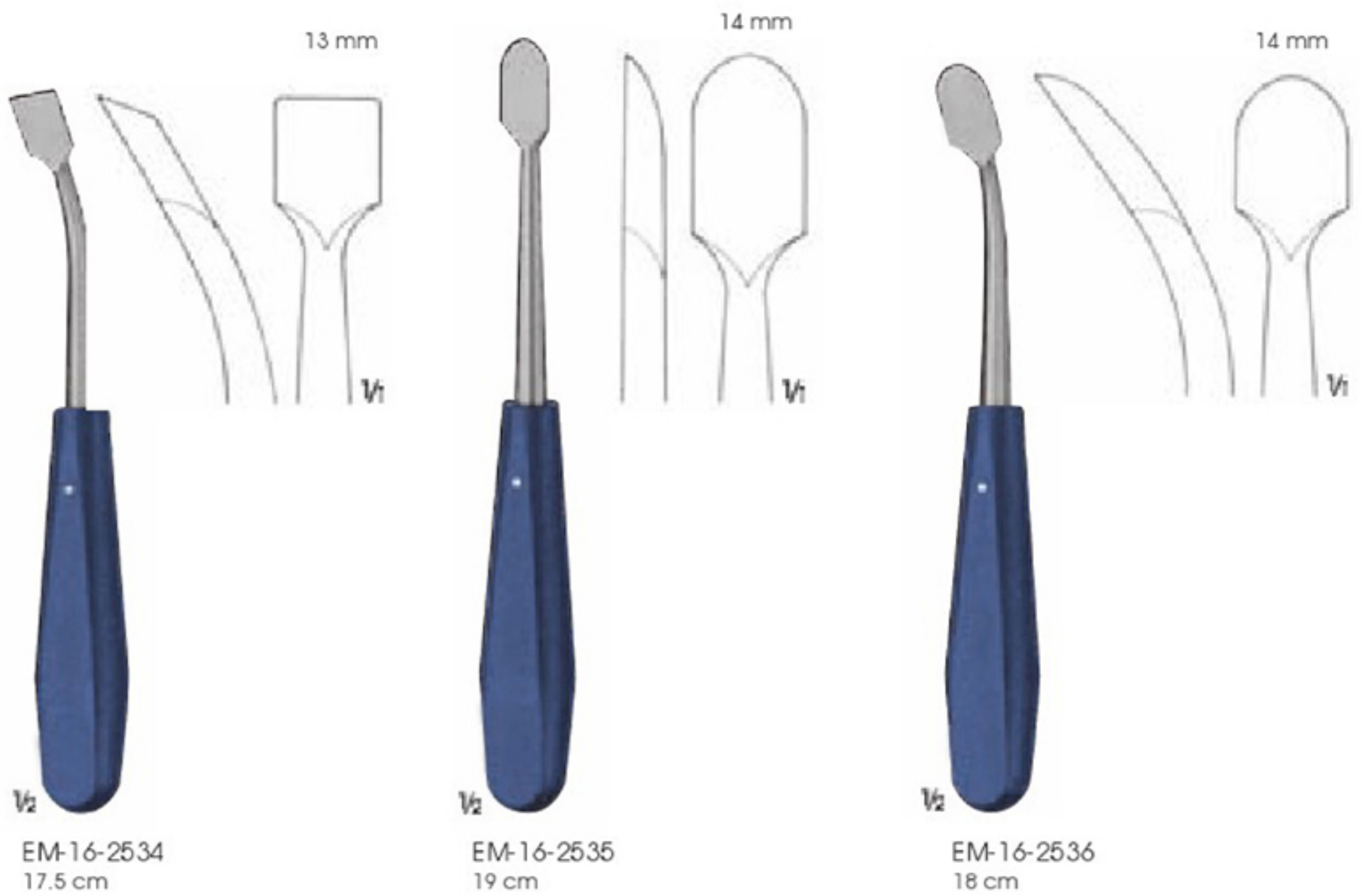
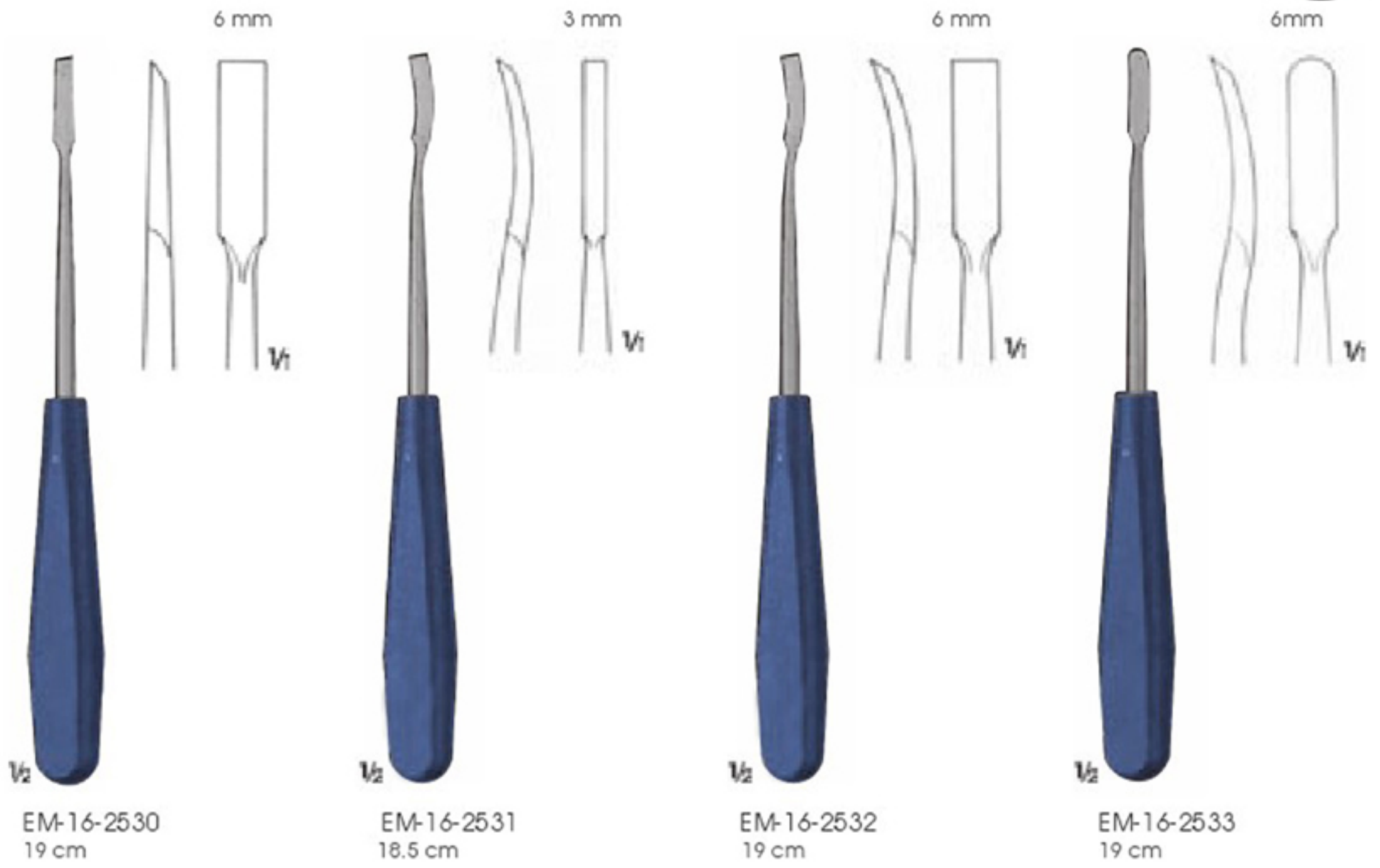



Can be sterilized in a steam sterilizer up to 143°



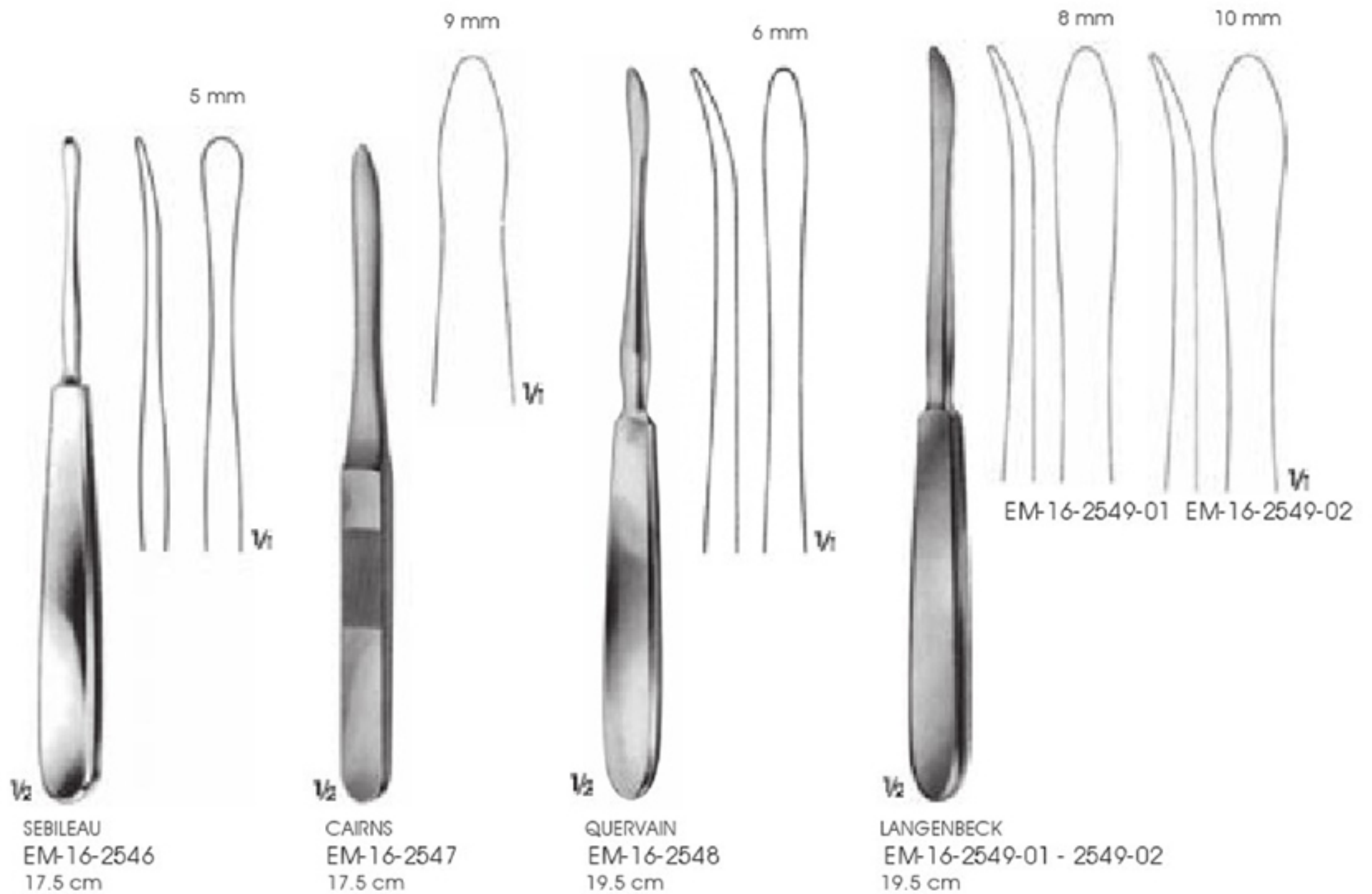
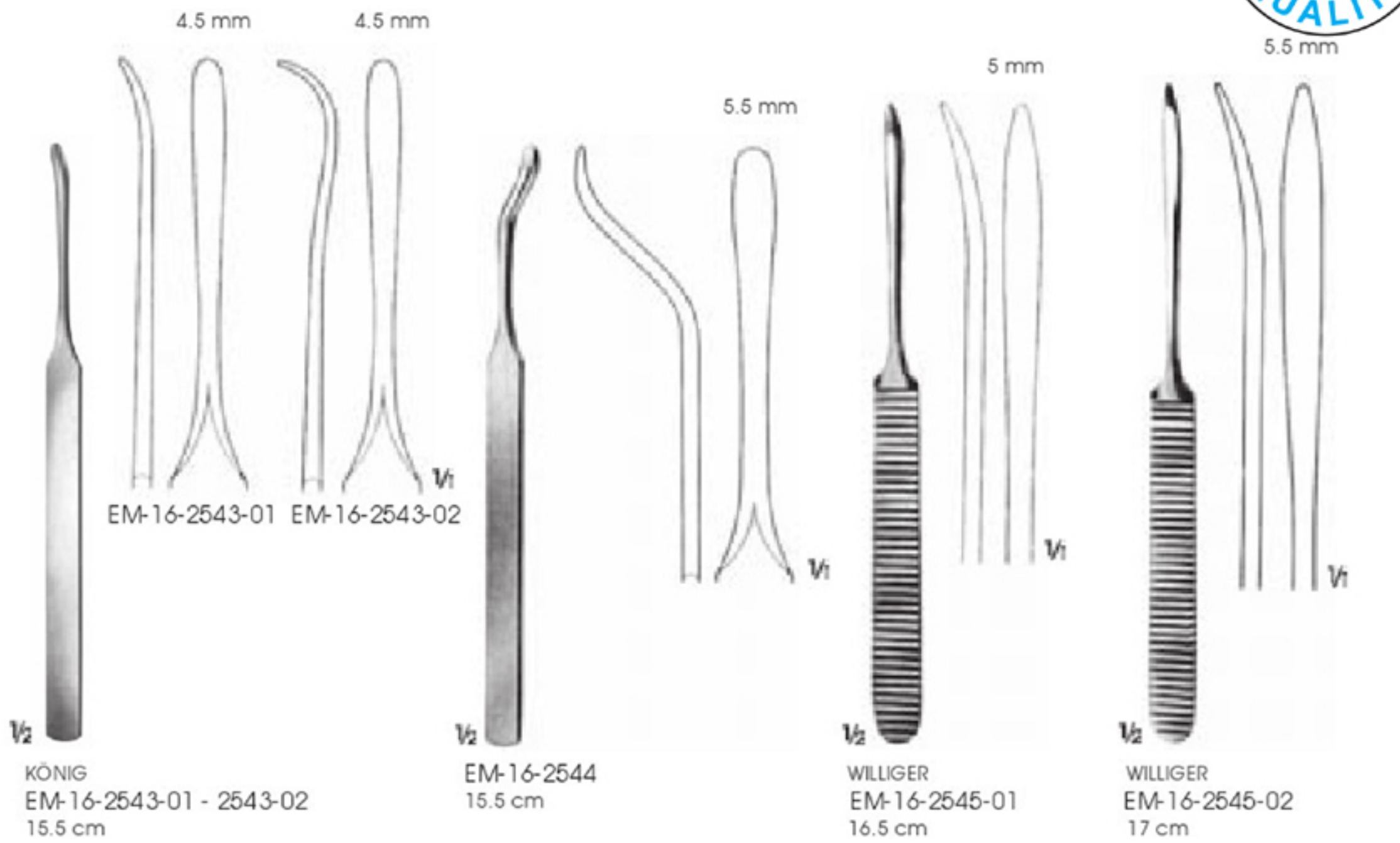



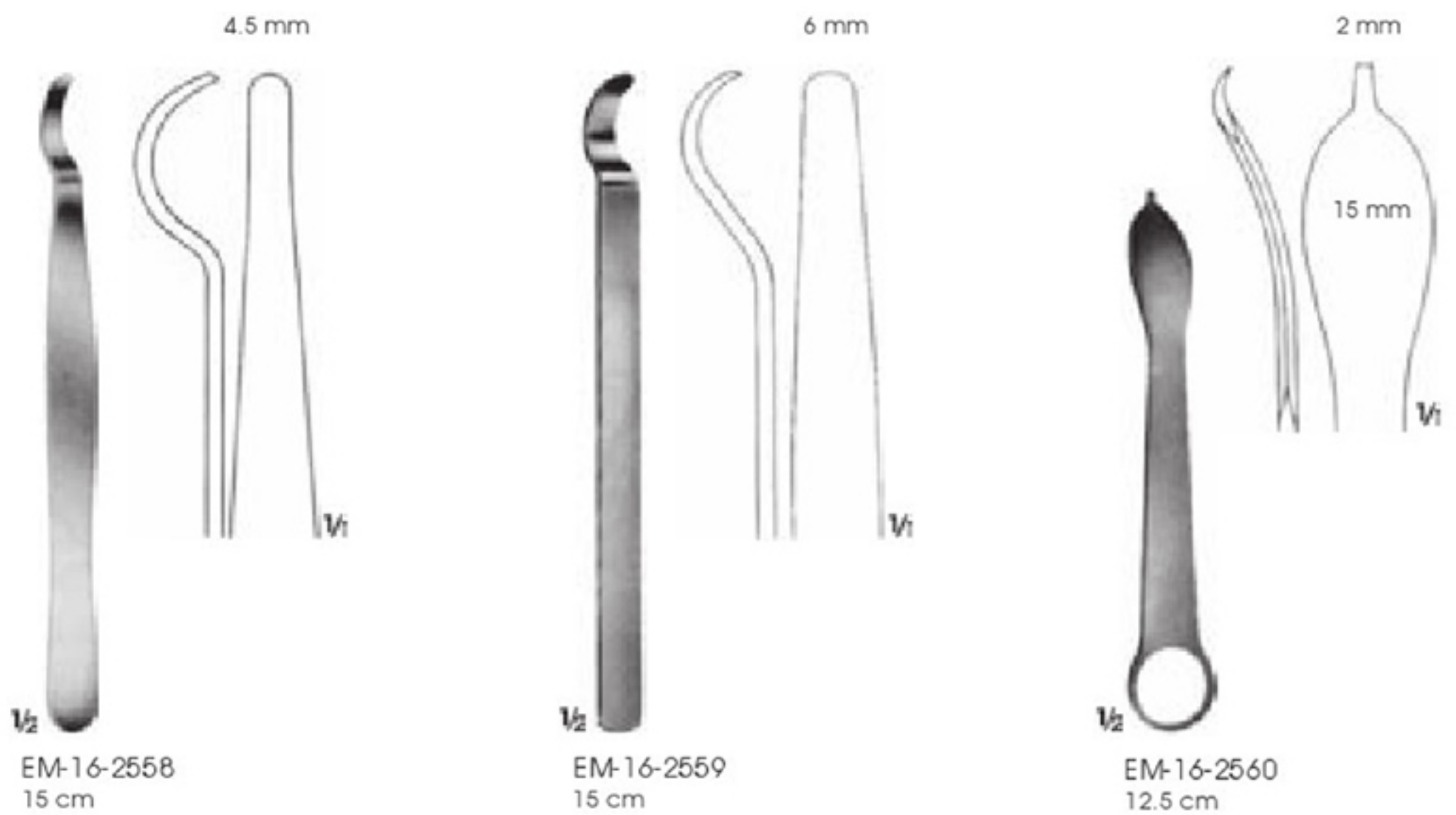
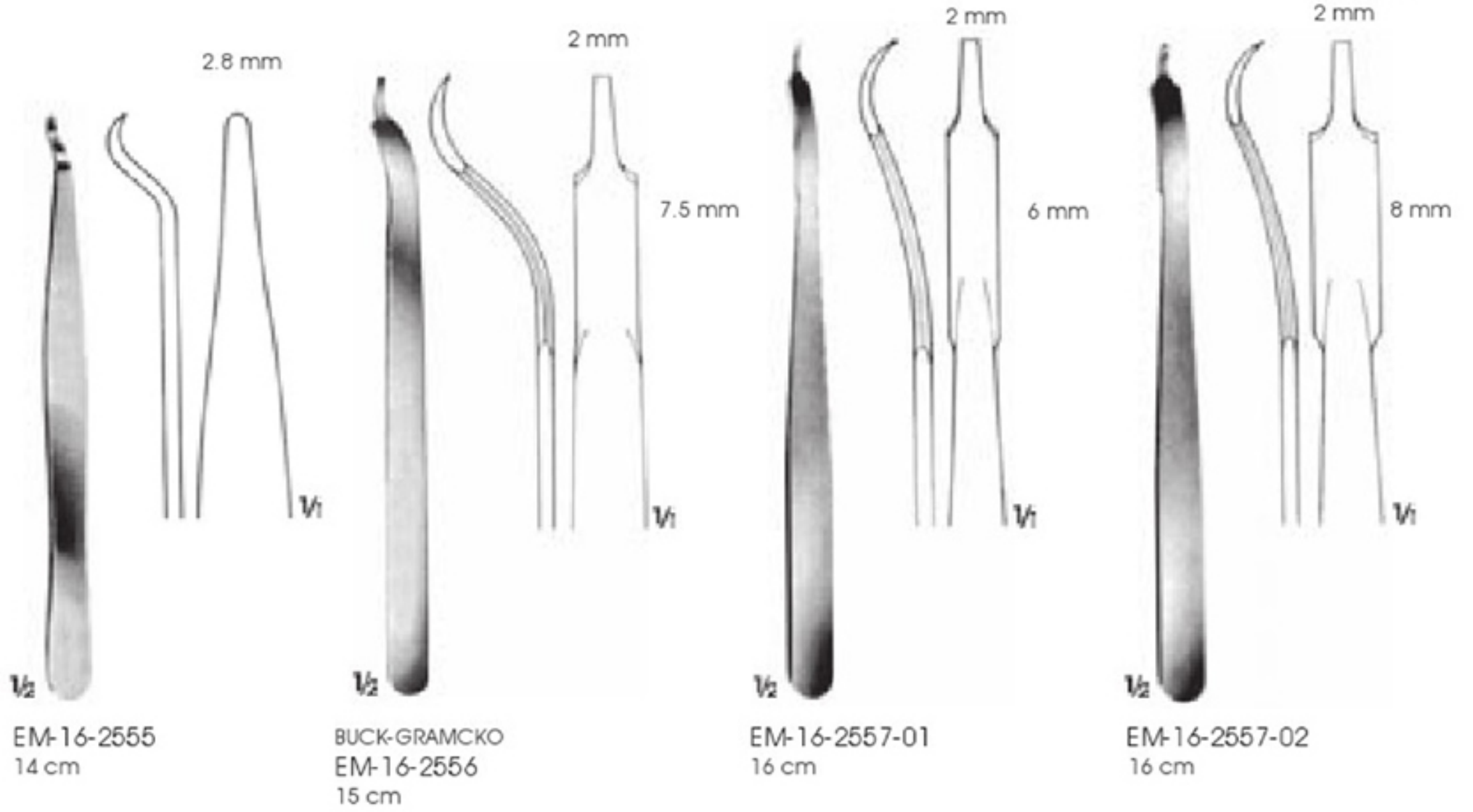

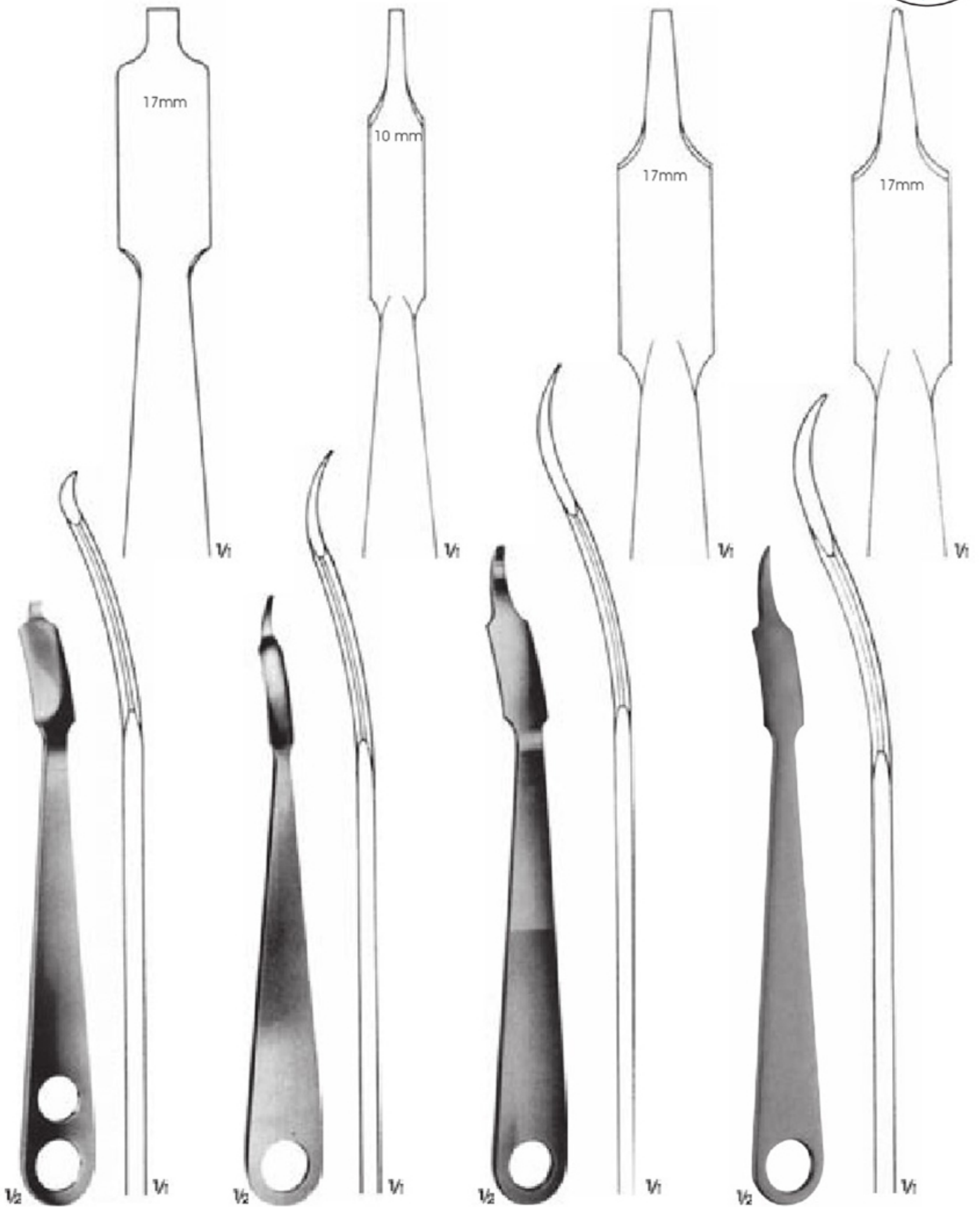

WAGNER
EM-16-2561
22 cm

EM-16-2562-01
22 cm

EM-16-2562-02
24 cm

EM-16-2562-03
24 cm



VATSON-JONES
EM-16-2563
28 cm

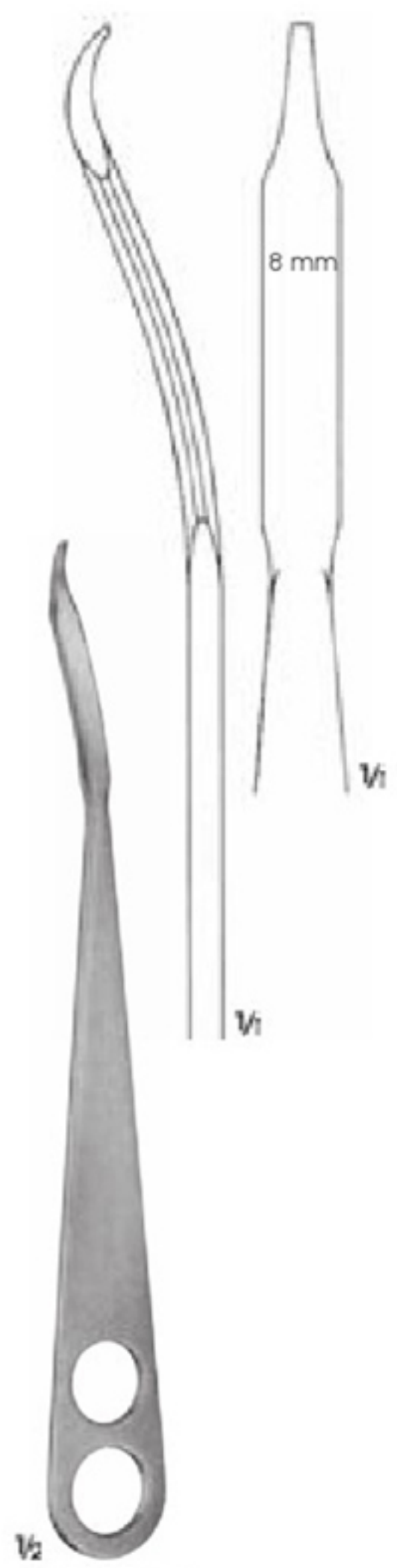

EM-16-2564
22 cm

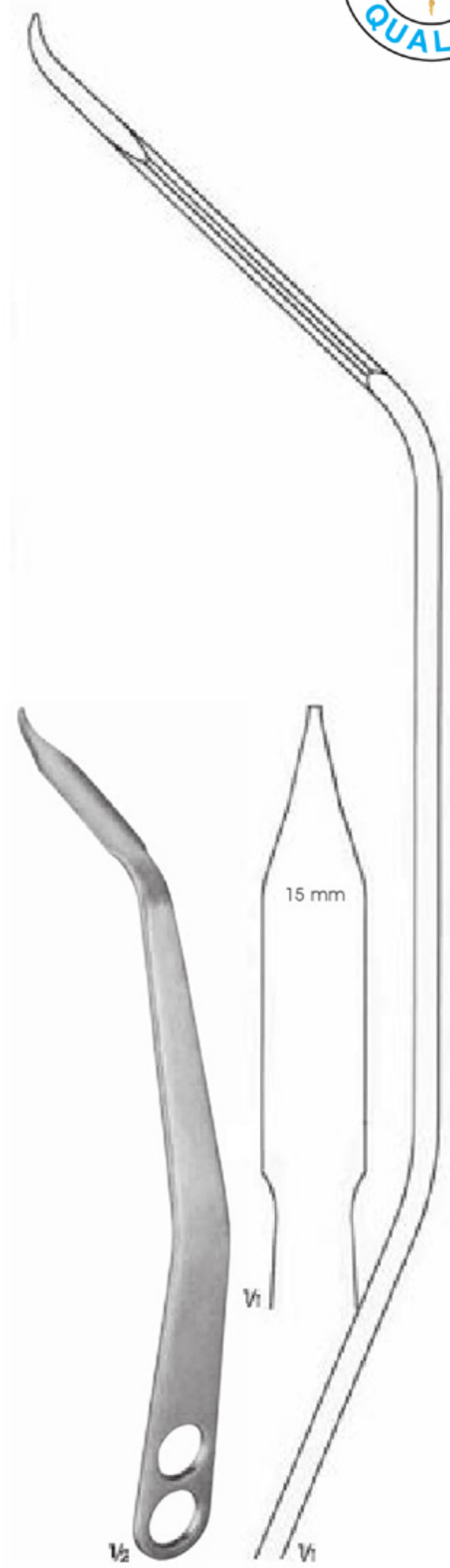

EM-16-2565
25 cm

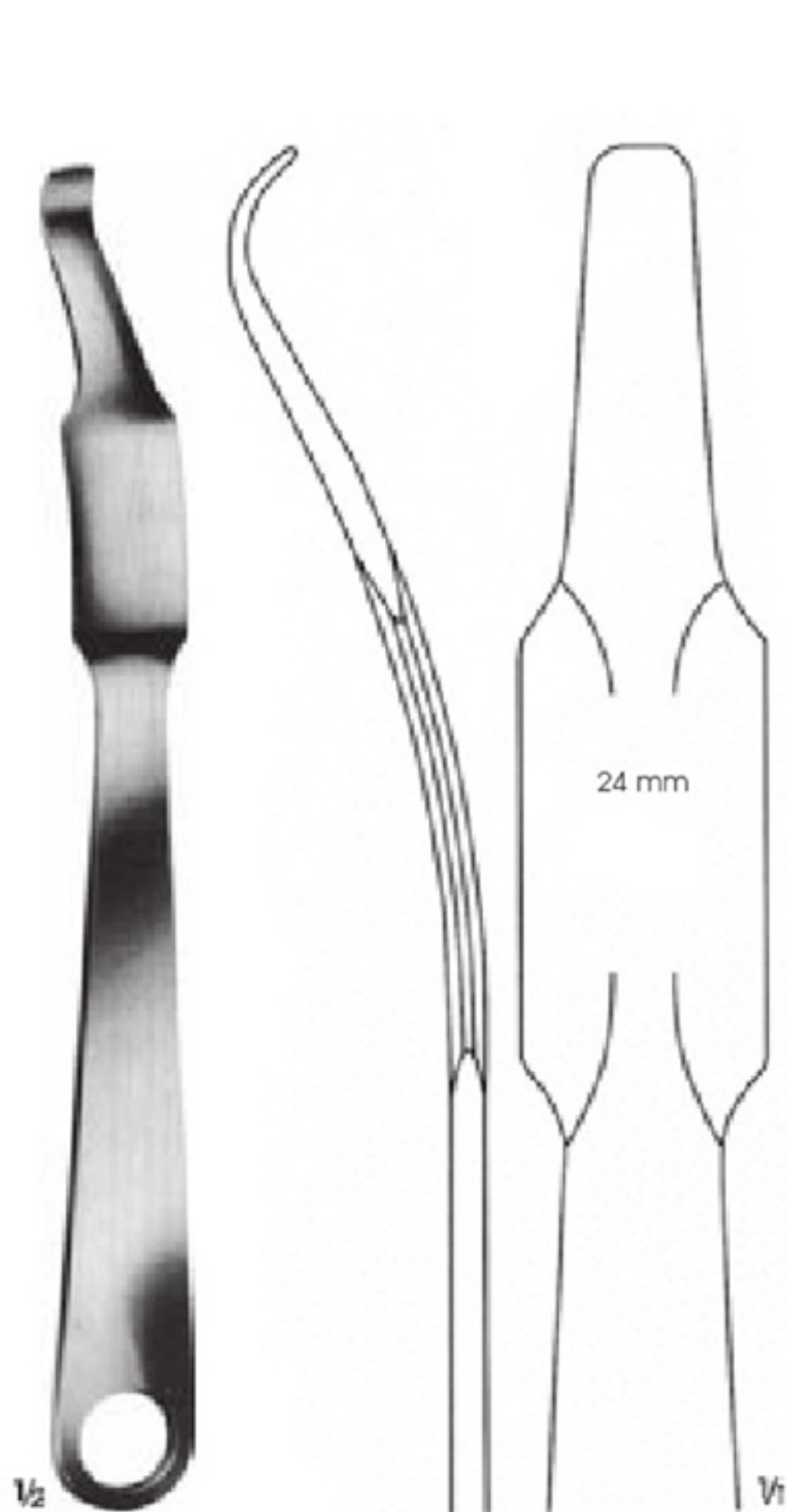

HOHMANN
EM-16-2566-01
26 cm

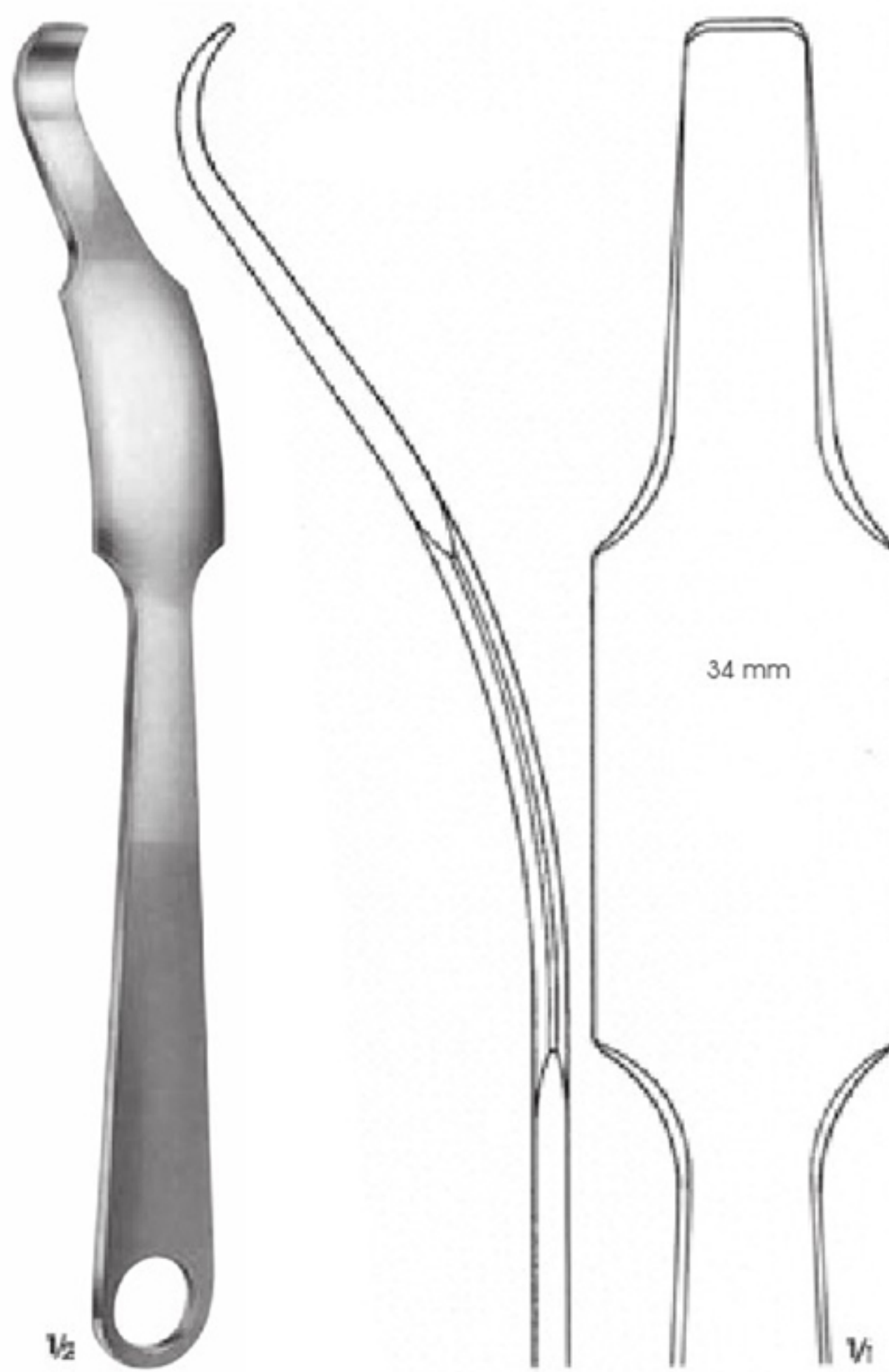

HOHMANN
EM-16-2566-02
28.5 cm

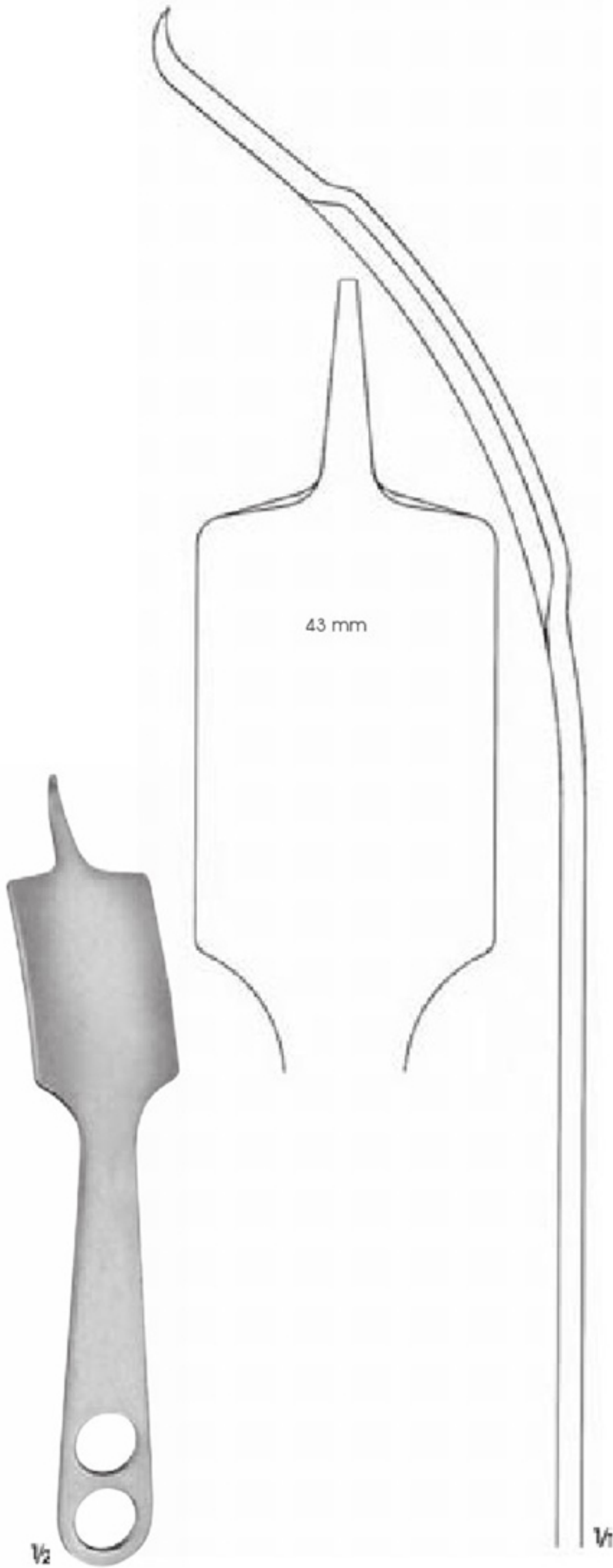

EM-16-2567
23 cm

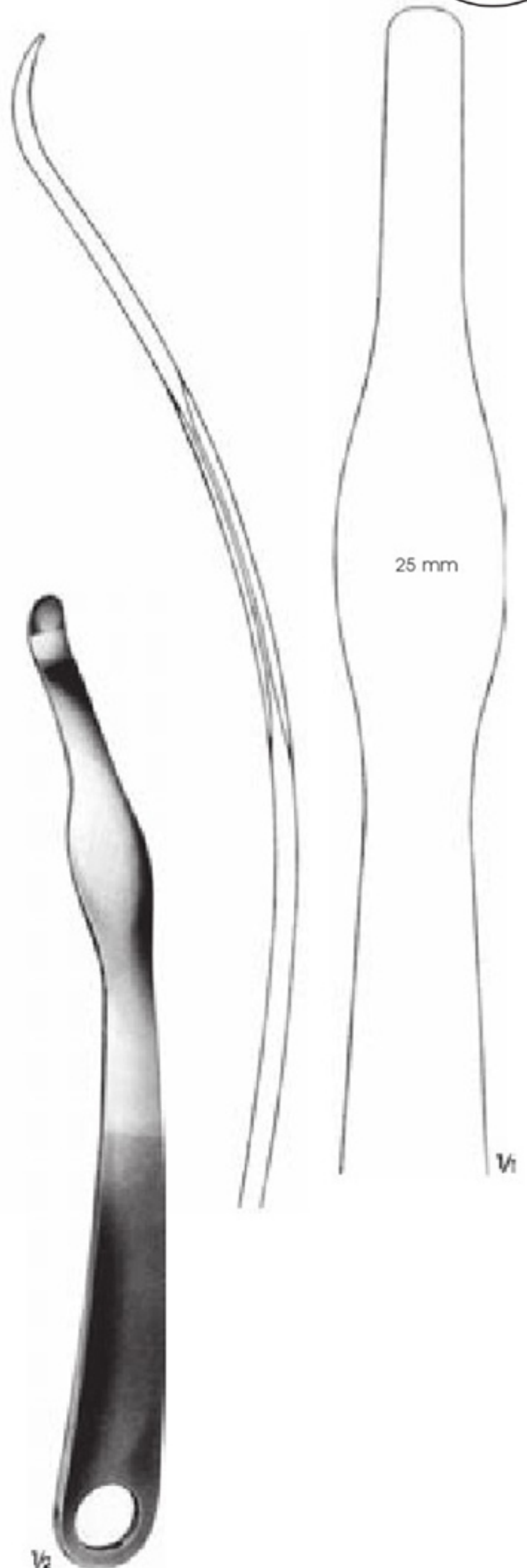

EM-16-2568
26 cm

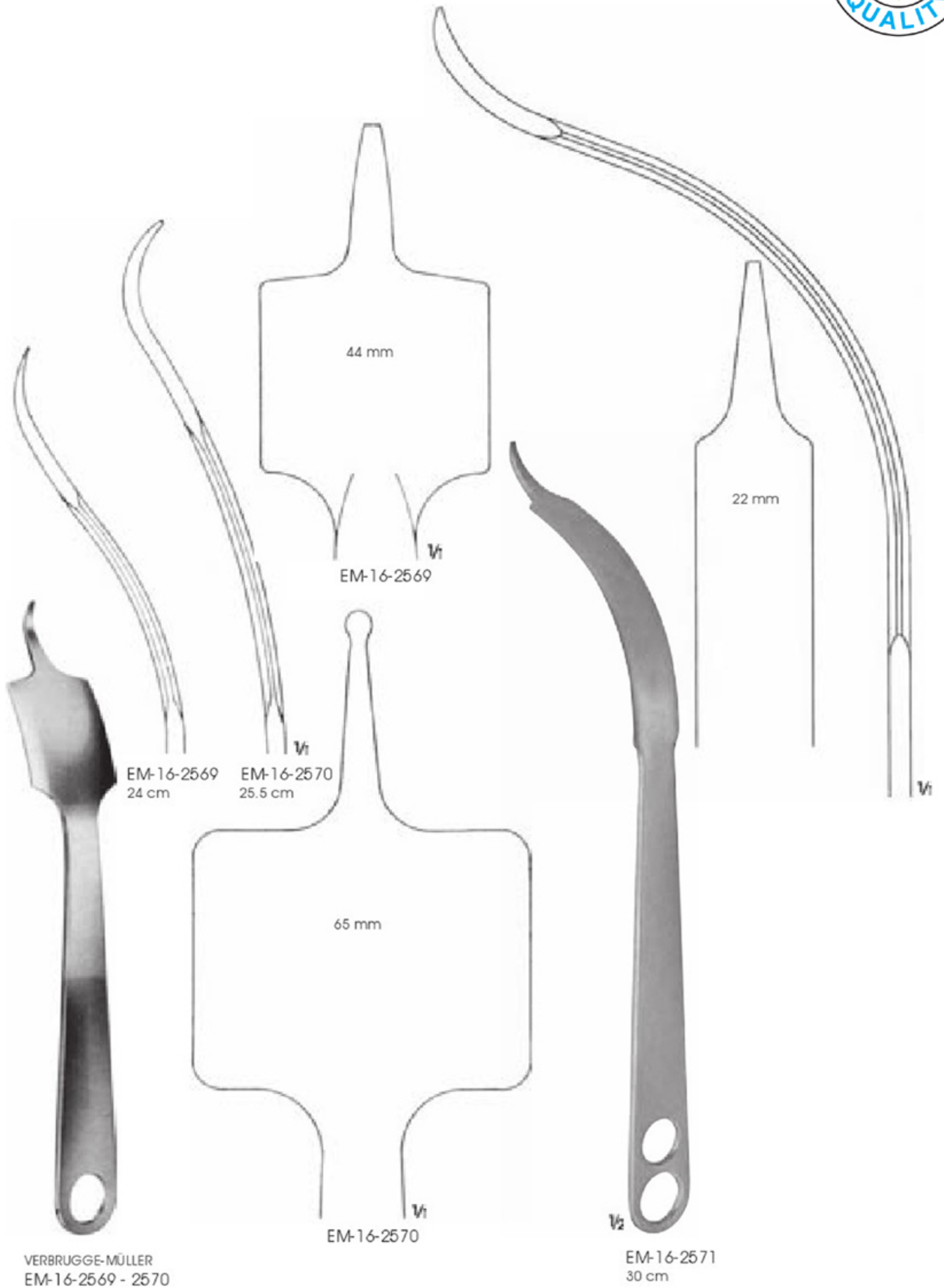

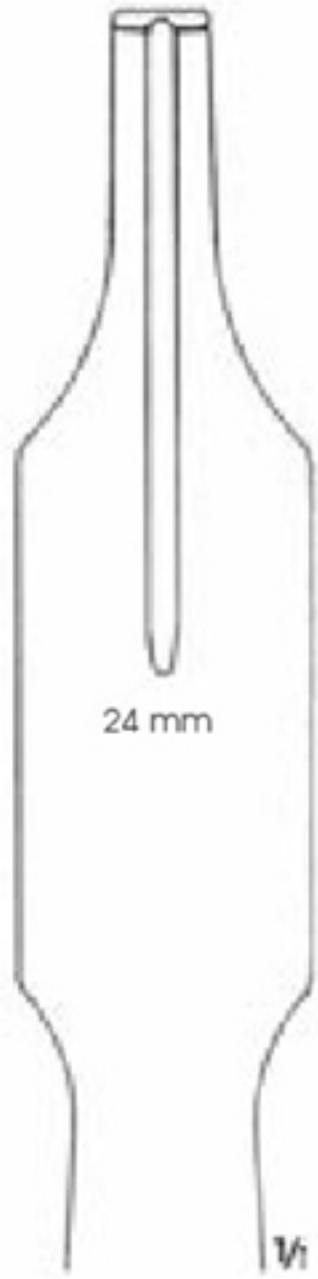

$\frac{1}{2}$
LANGE-HOHMANN
EM-16-2572
25 cm



$\frac{1}{2}$
LANGE-HOHMANN
EM-16-2573-01 26.5 cm
EM-16-2573-02 28 cm

EM-16-2573-01
30 mm

EM-16-2573-02
33 mm

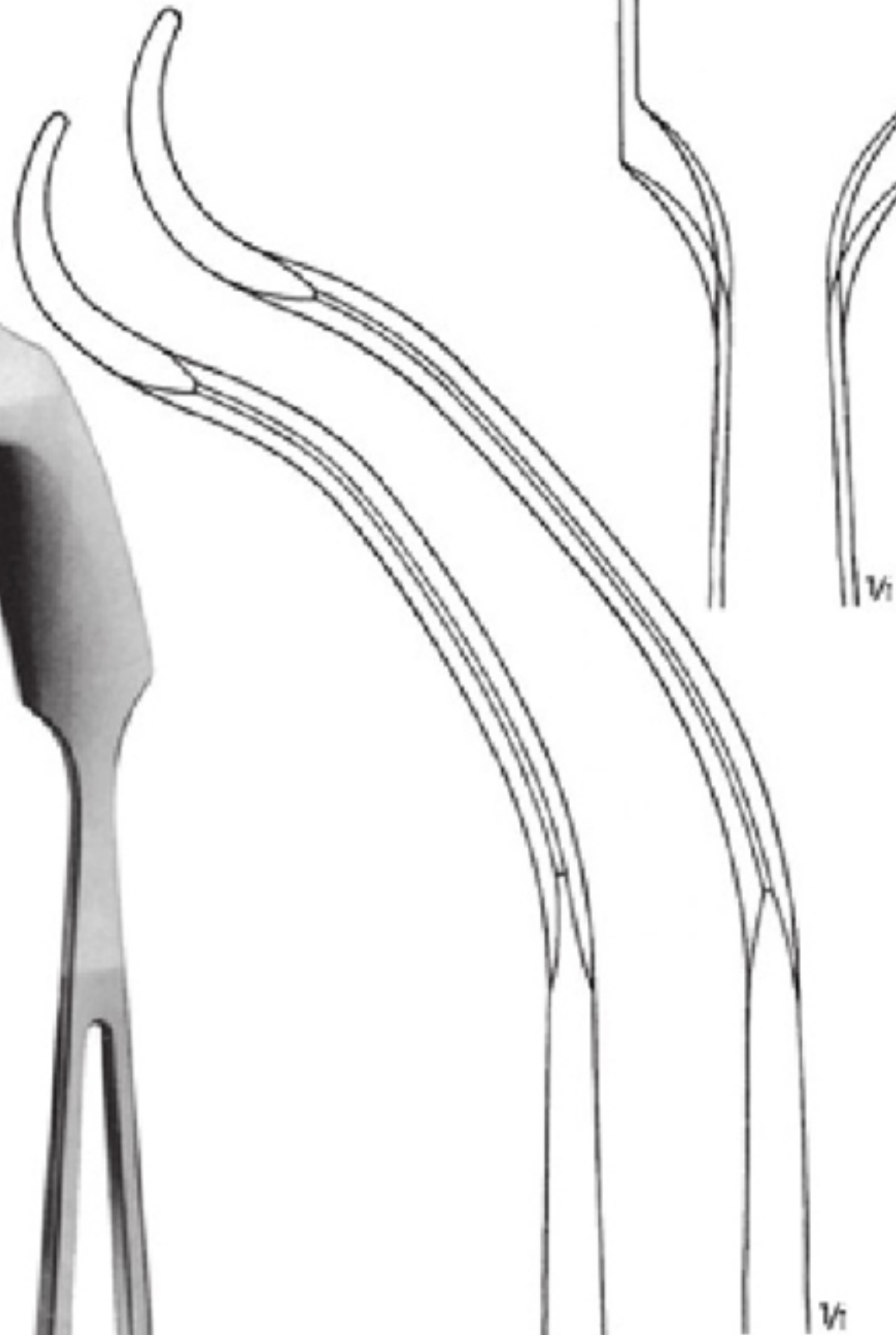

EM-16-2573-01 EM-16-2573-02

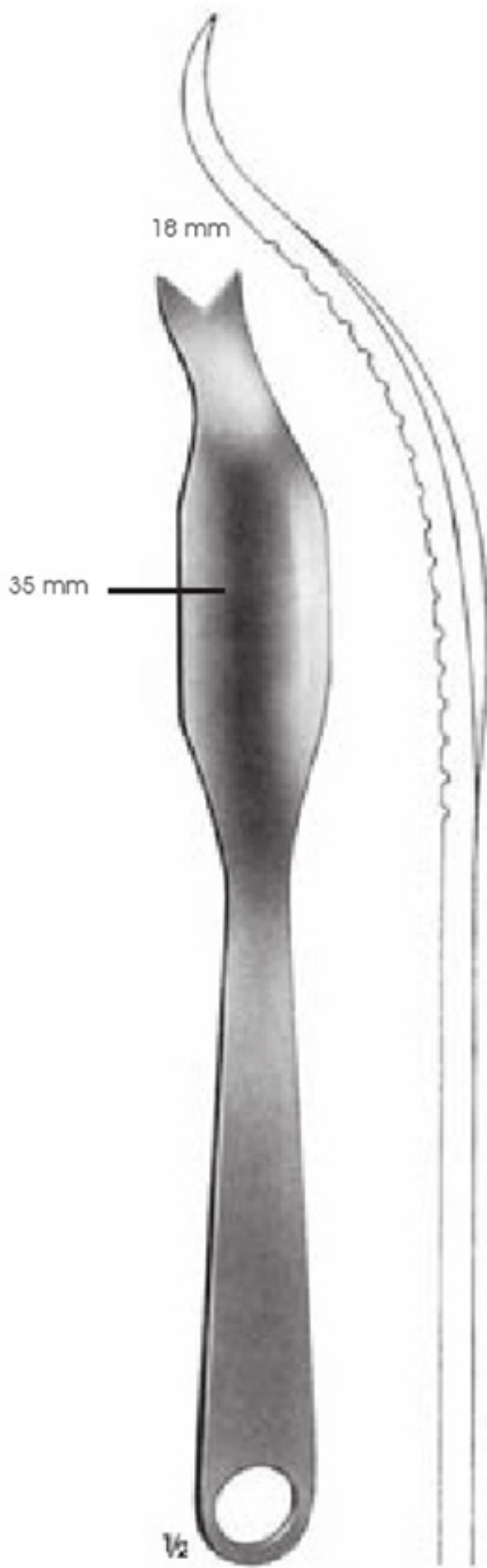

SCHUMACHER
EM-16-2574
29 cm



Reverse side



SCHUMACHER-WAGNER
EM-16-2575
35.5 cm

40 mm

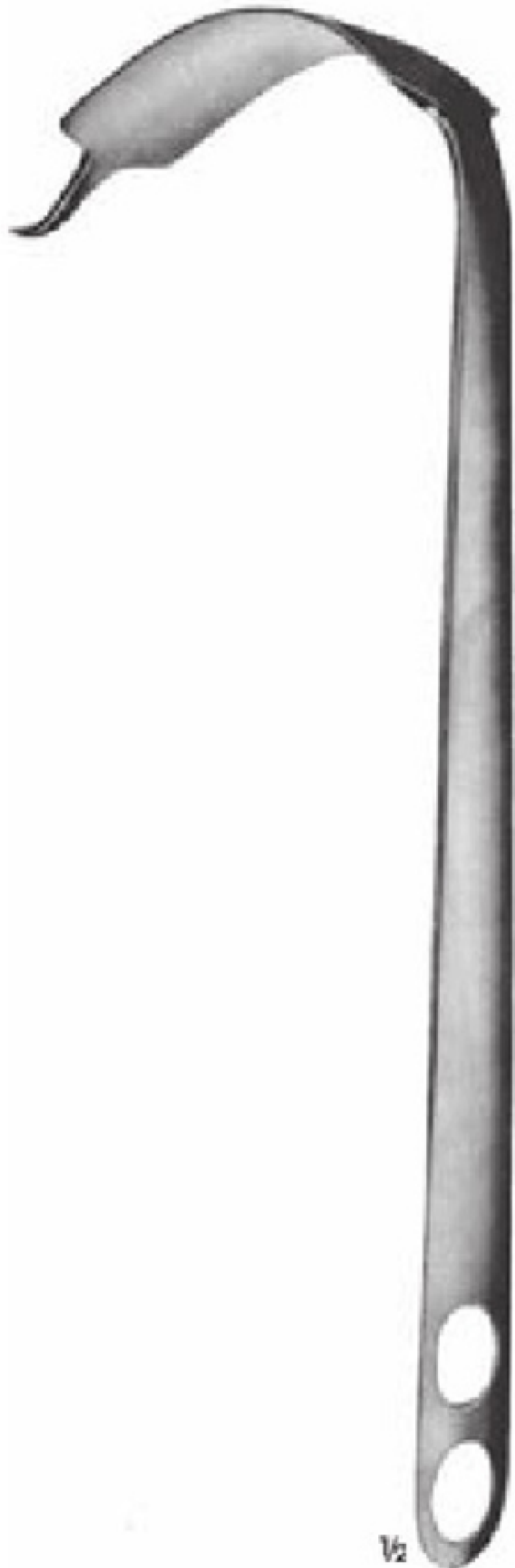

1/2

EM-16-2576
32 cm

40 mm



1/2

EM-16-2577
32 cm

26 mm



1/2

EM-16-2578
Femoral retractor
38 cm

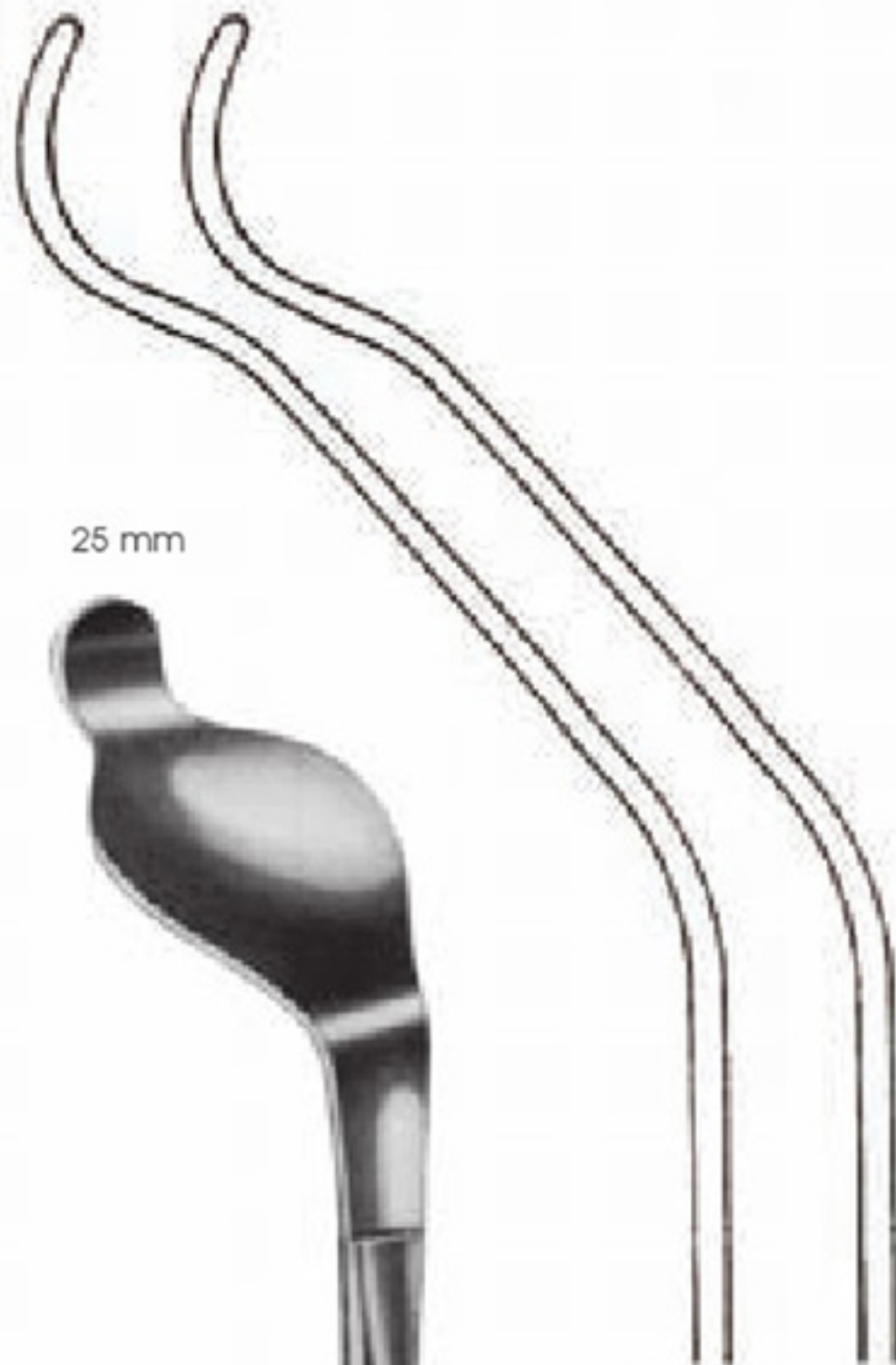

25 mm

EM-16-2579-01
65 mm

EM-16-2579-02
44 mm

1/2

1/2

BENNETT
EM-16-2579-01 25 mm-44 mm
EM-16-2579-02 25 mm-65 mm
23.5 cm

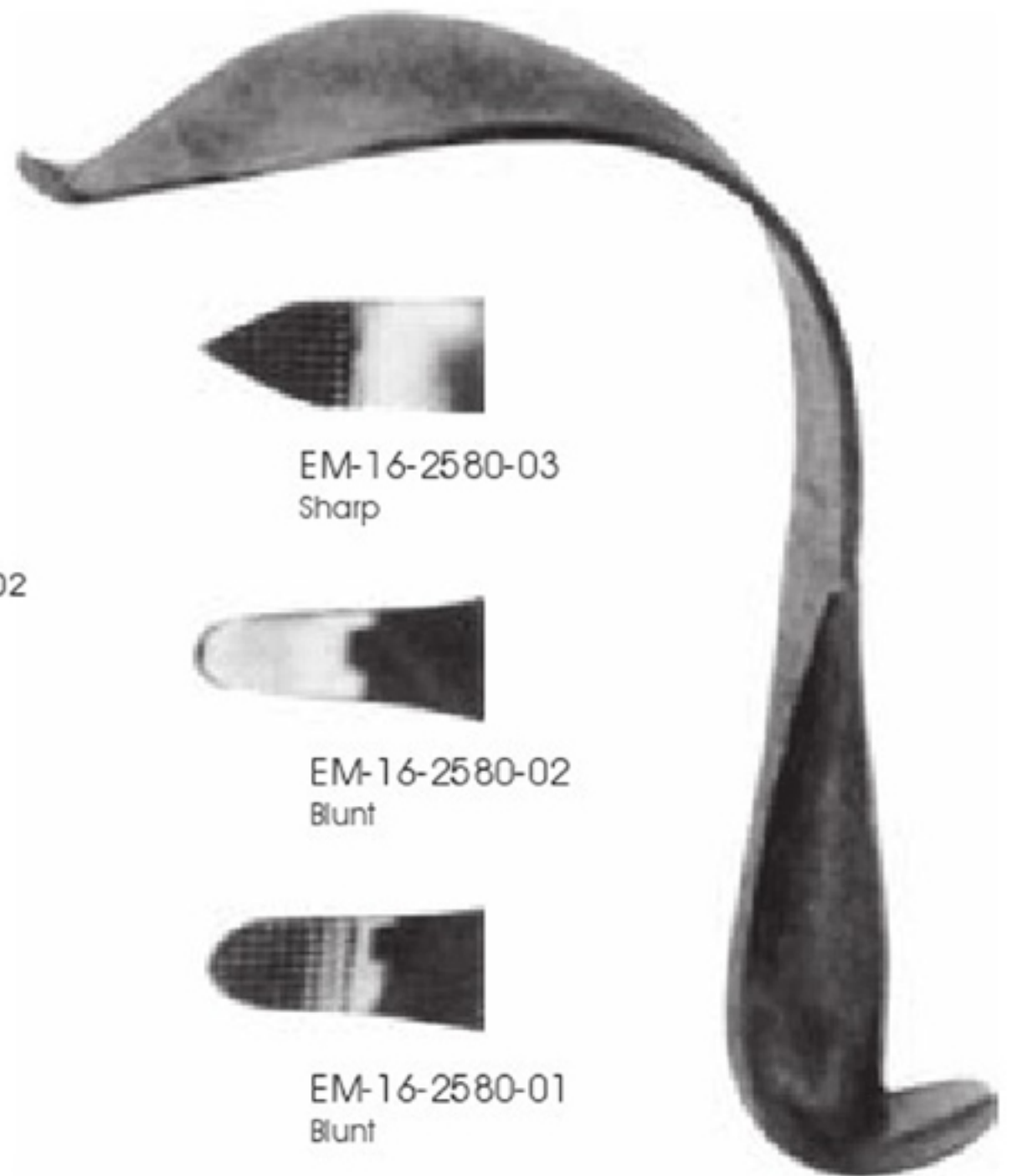

EM-16-2580-03
Sharp

EM-16-2580-02
Blunt

EM-16-2580-01
Blunt

COBRA
EM-16-2580-01 - 2580-03
28 cm



HOHMANN-ALDINGER
EM-16-2581
27 cm



EM-16-2582
29 cm



TAGER
EM-16-2583
Bone lever for angle joint operations
17.5 cm



BLOUNT
EM-16-2584
27 cm



MURPHY-LANE
EM-16-2585
Luxation lever
33 cm



30 mm

$\frac{1}{2}$

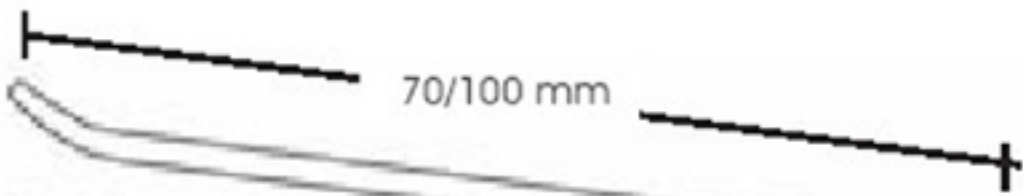

70/100 mm



TAYLOR
EM-16-2586-01 30 x 70 mm
18.5 cm
EM-16-2586-02 30 x 100 mm
20 cm



EM-16-2587-03
25 x 75 mm



EM-16-2587-02
20 x 50 mm



EM-16-2587-01
13 x 25 mm

$\frac{1}{2}$

HIBBS
EM-16-2587-01 - 2587-03
23.5 cm

90°

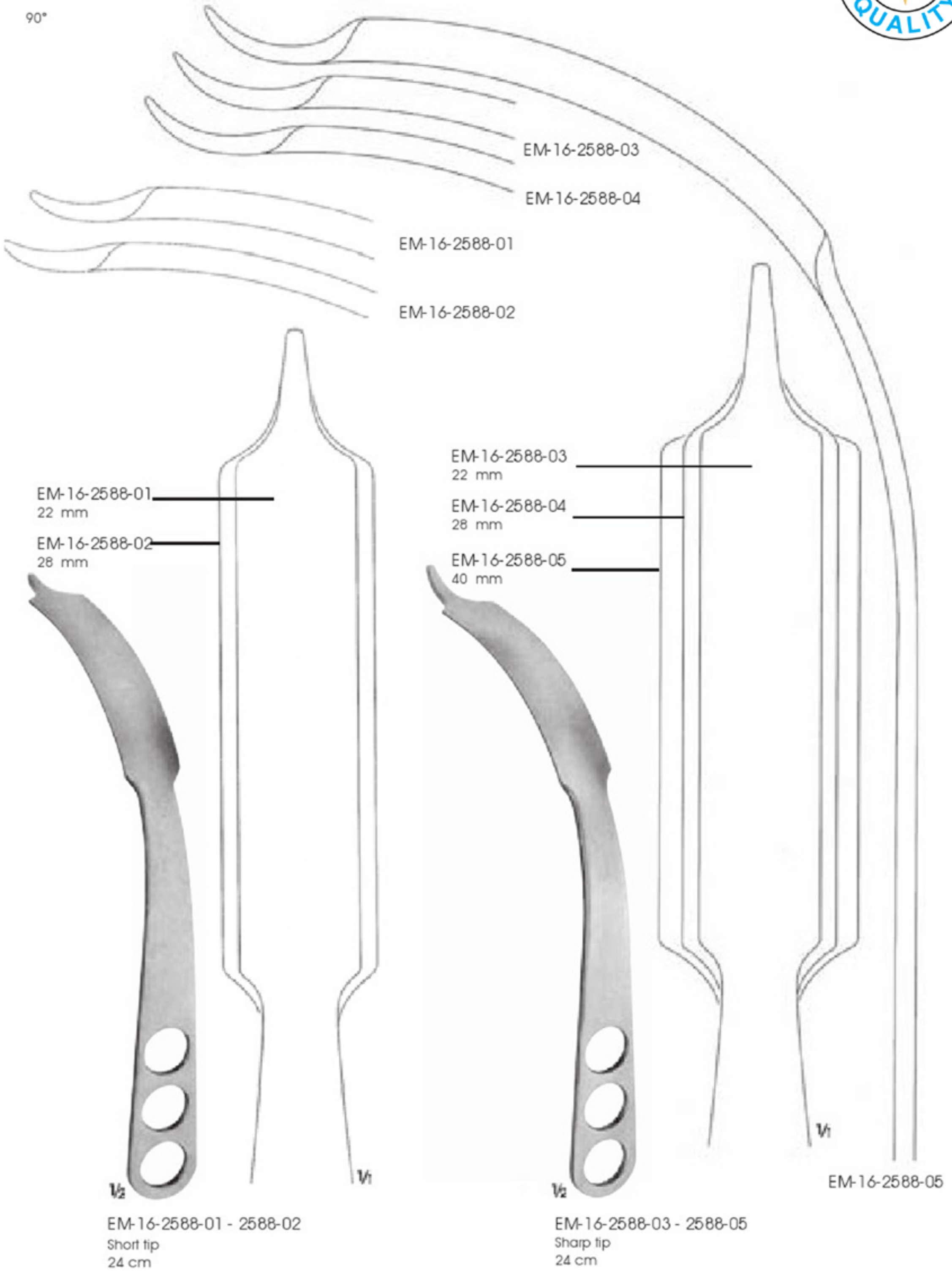

90°

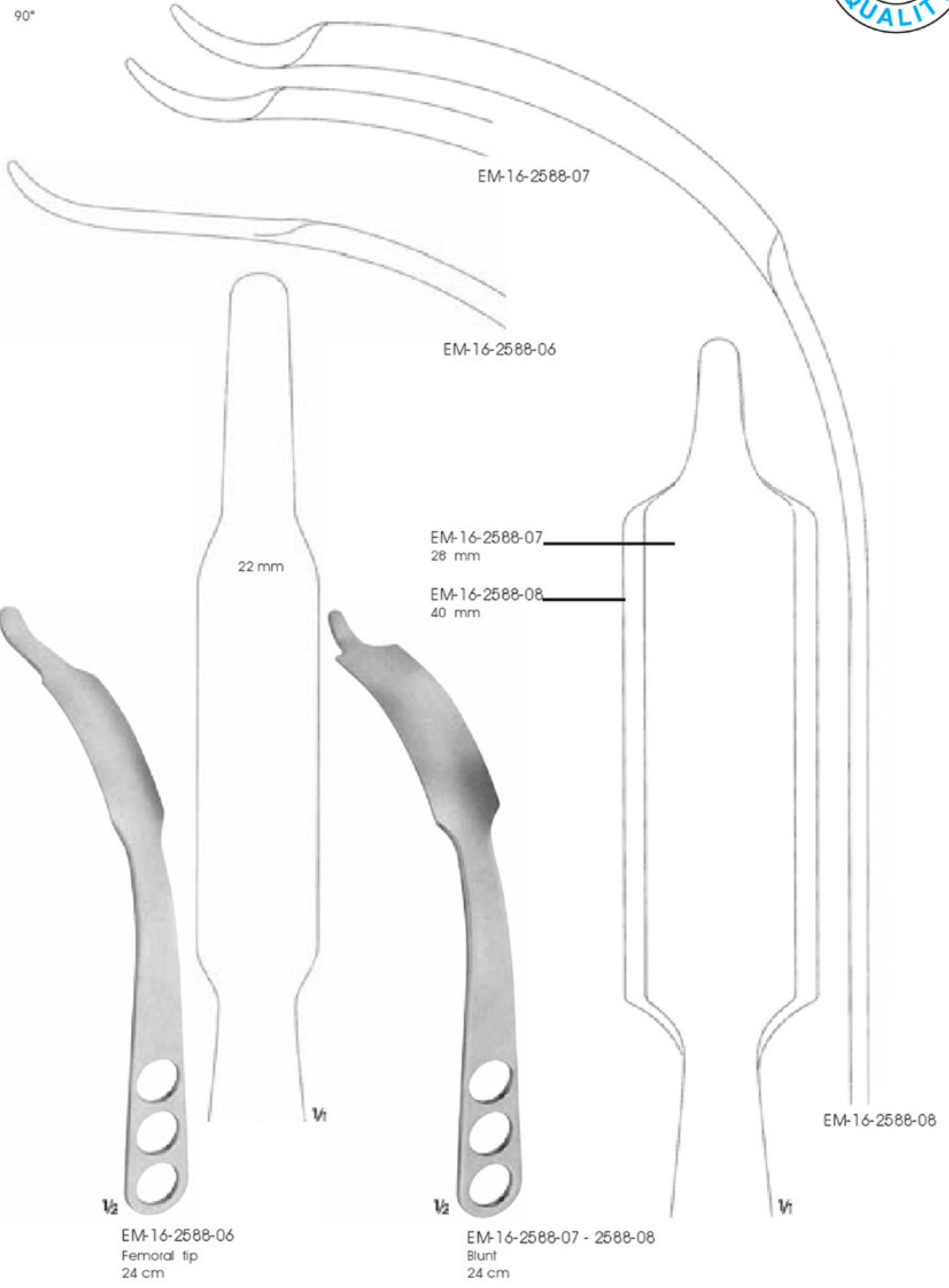

EM-16-2588-06
Femoral tip
24 cm

EM-16-2588-07 - 2588-08
Blunt
24 cm

45°

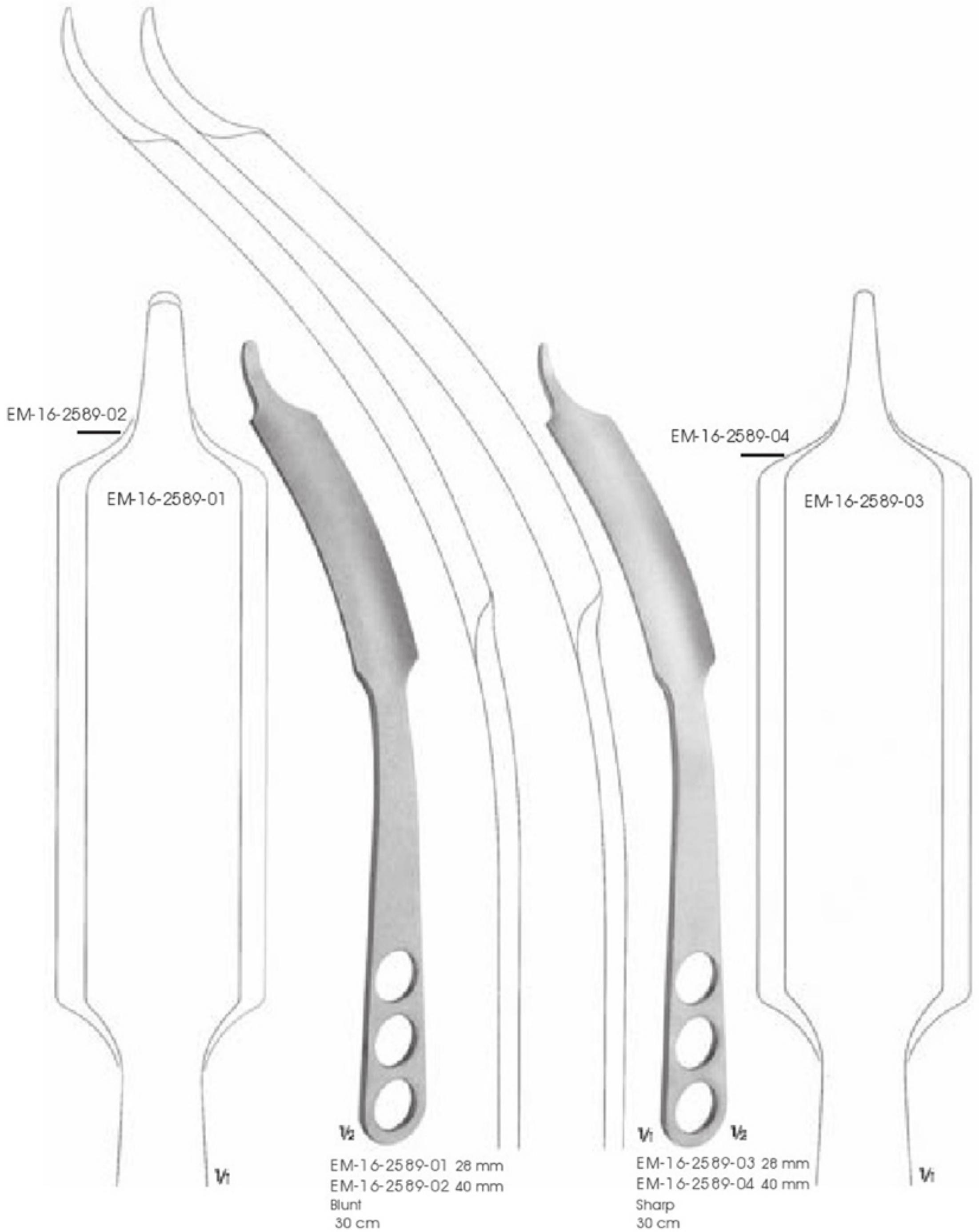

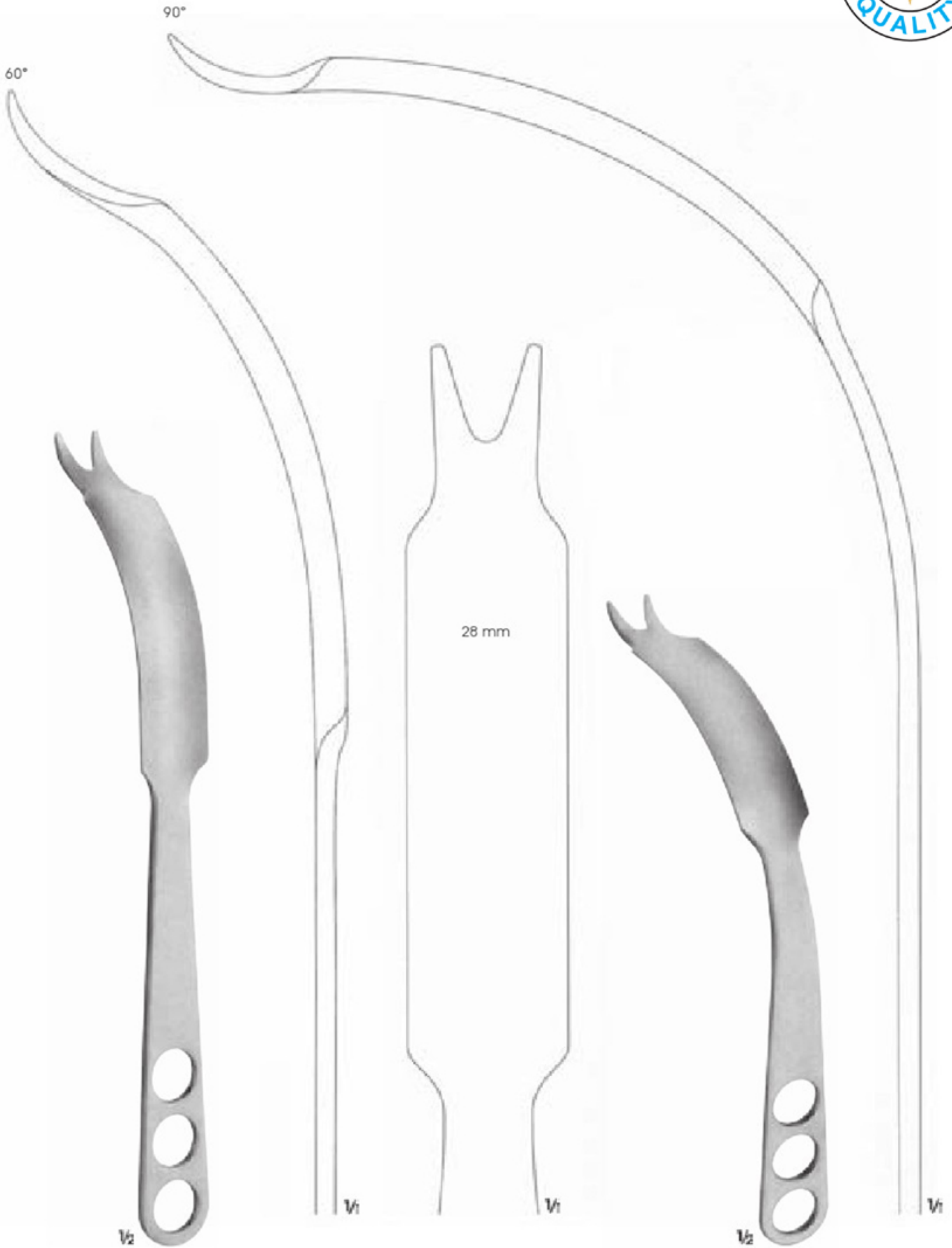

EM-16-2590
V-tip
30 cm

EM-16-2588-09
V-tip
24 cm

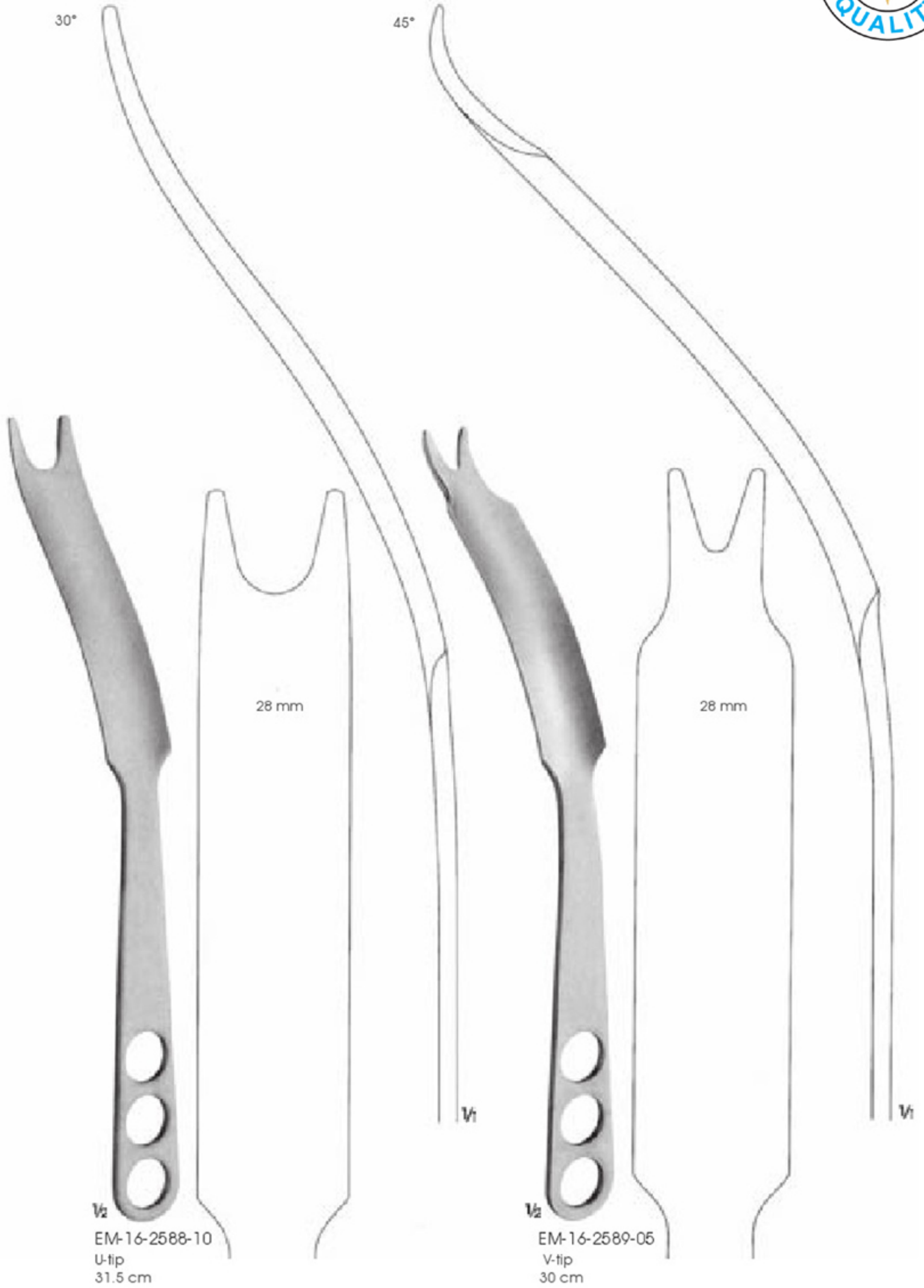

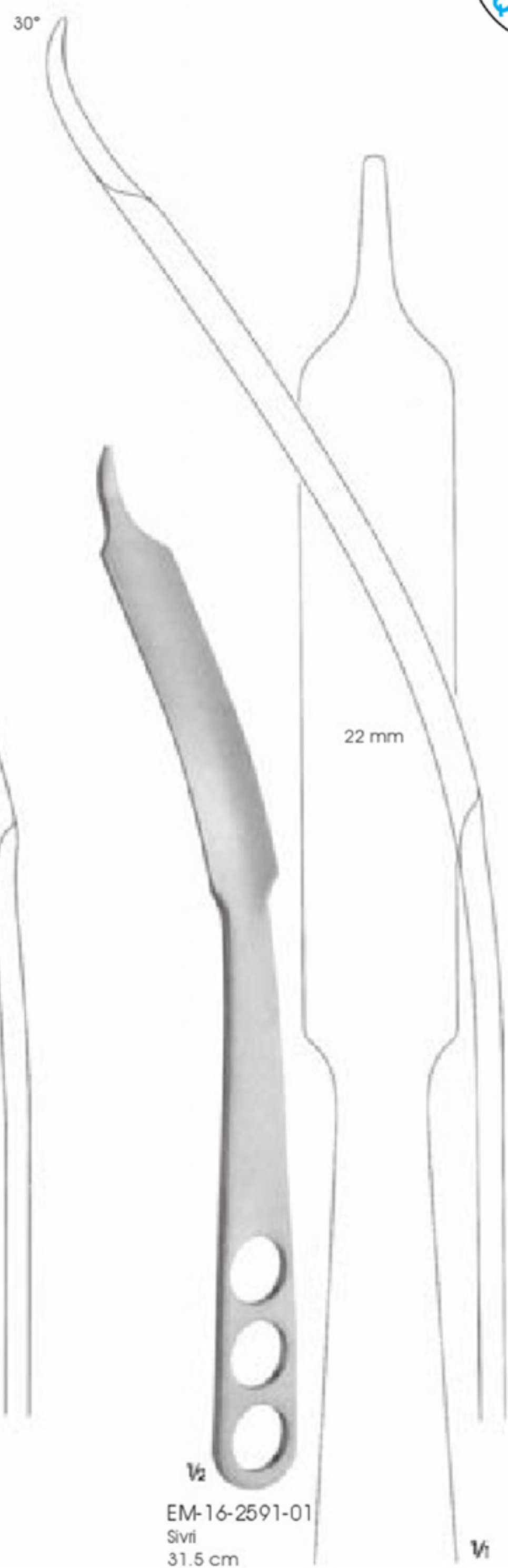
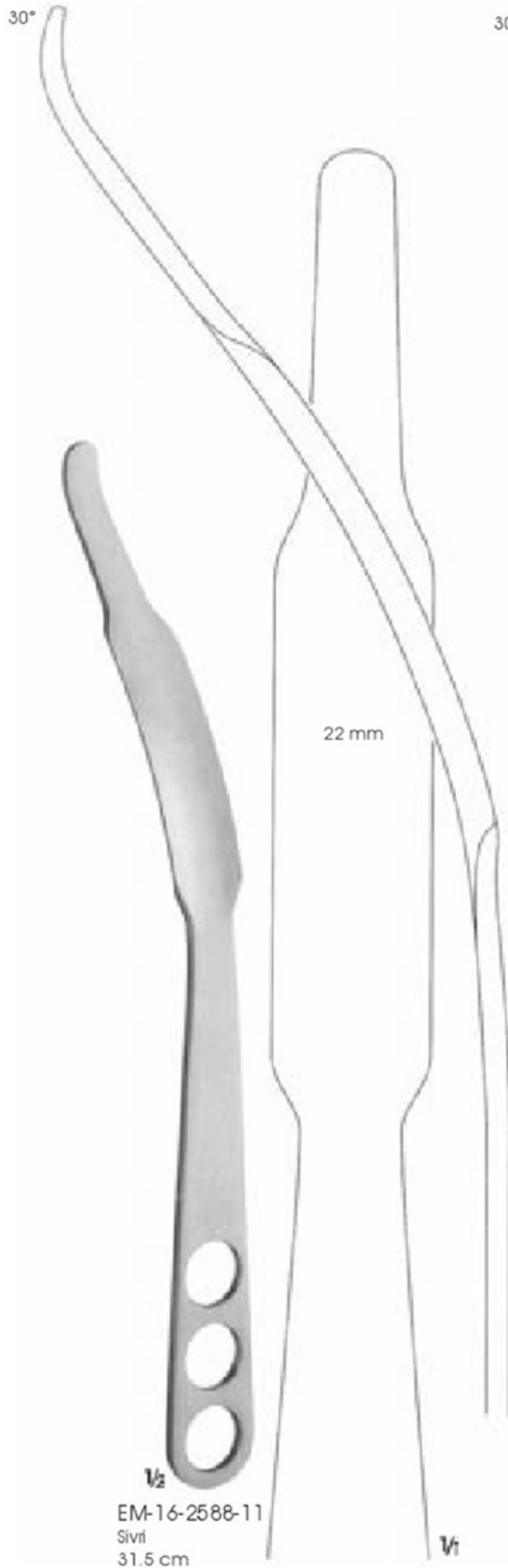

30°

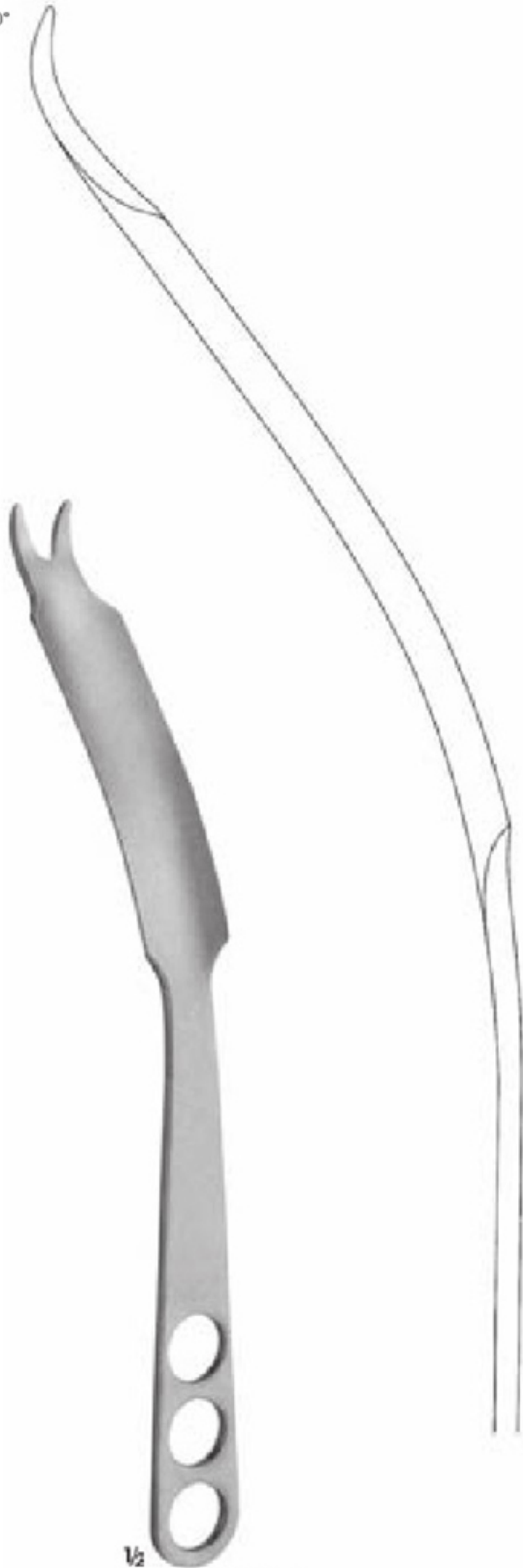

EM-16-2591-02
V-Tip/V-Tip
31.5 cm



28 mm

EM-16-2592-01
Hand grip

EM-16-2592-02
Hand grip

EM-16-2592-03
Hand grip

EM-16-2592-04
Hand grip



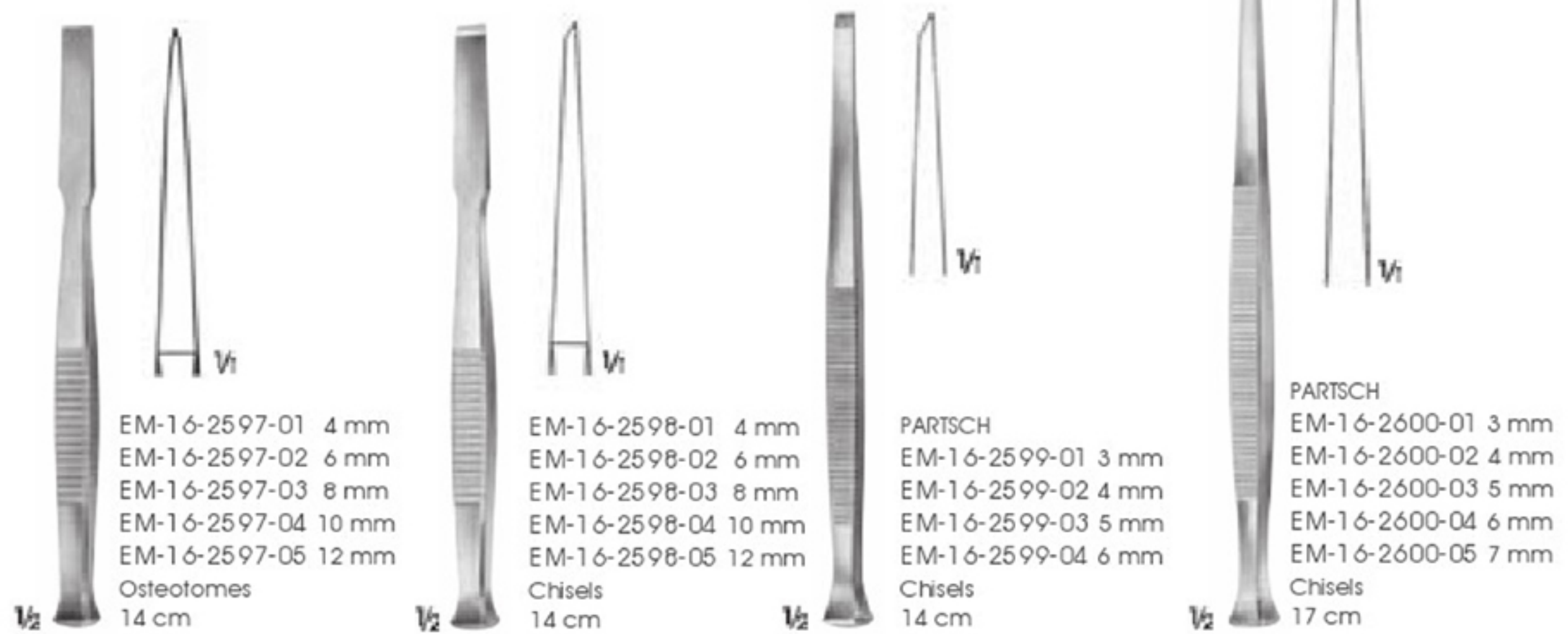
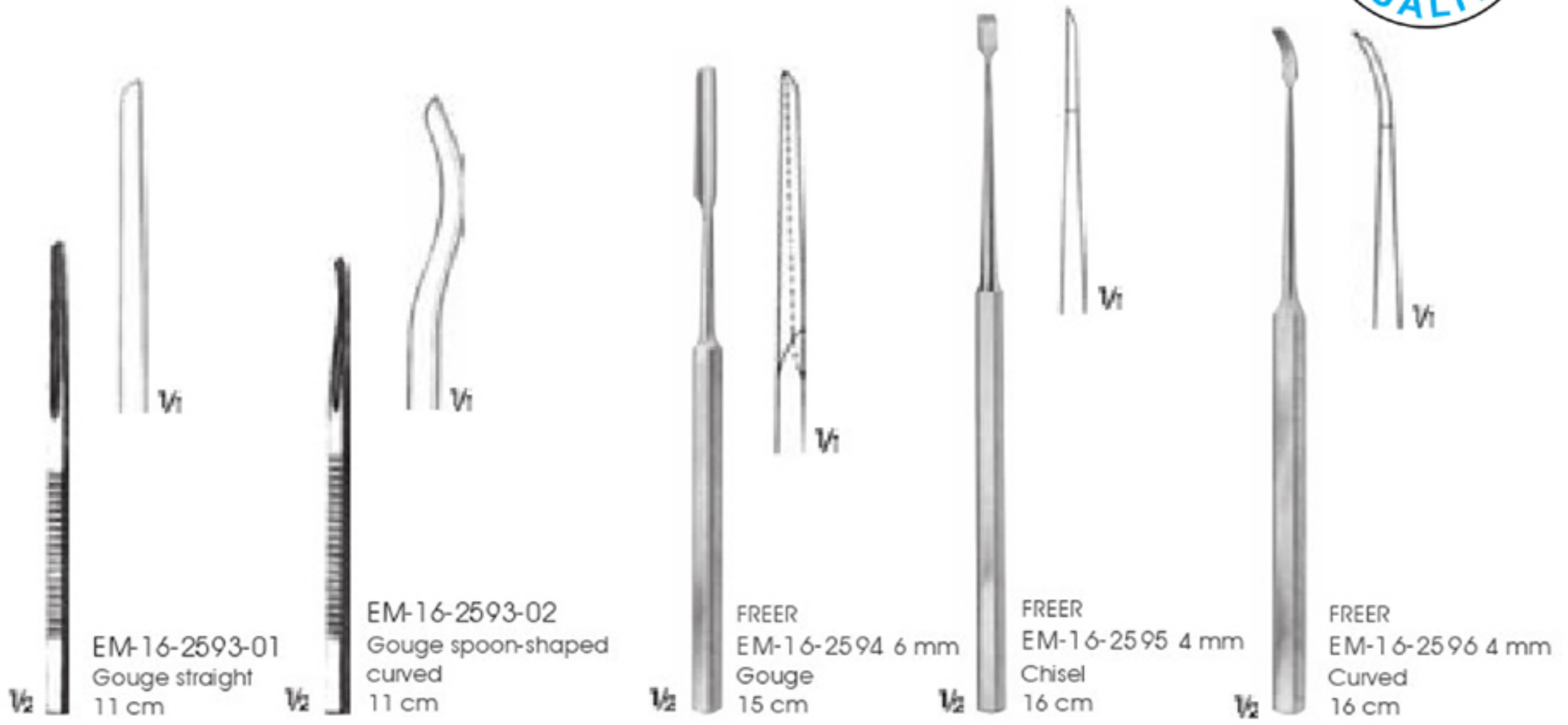

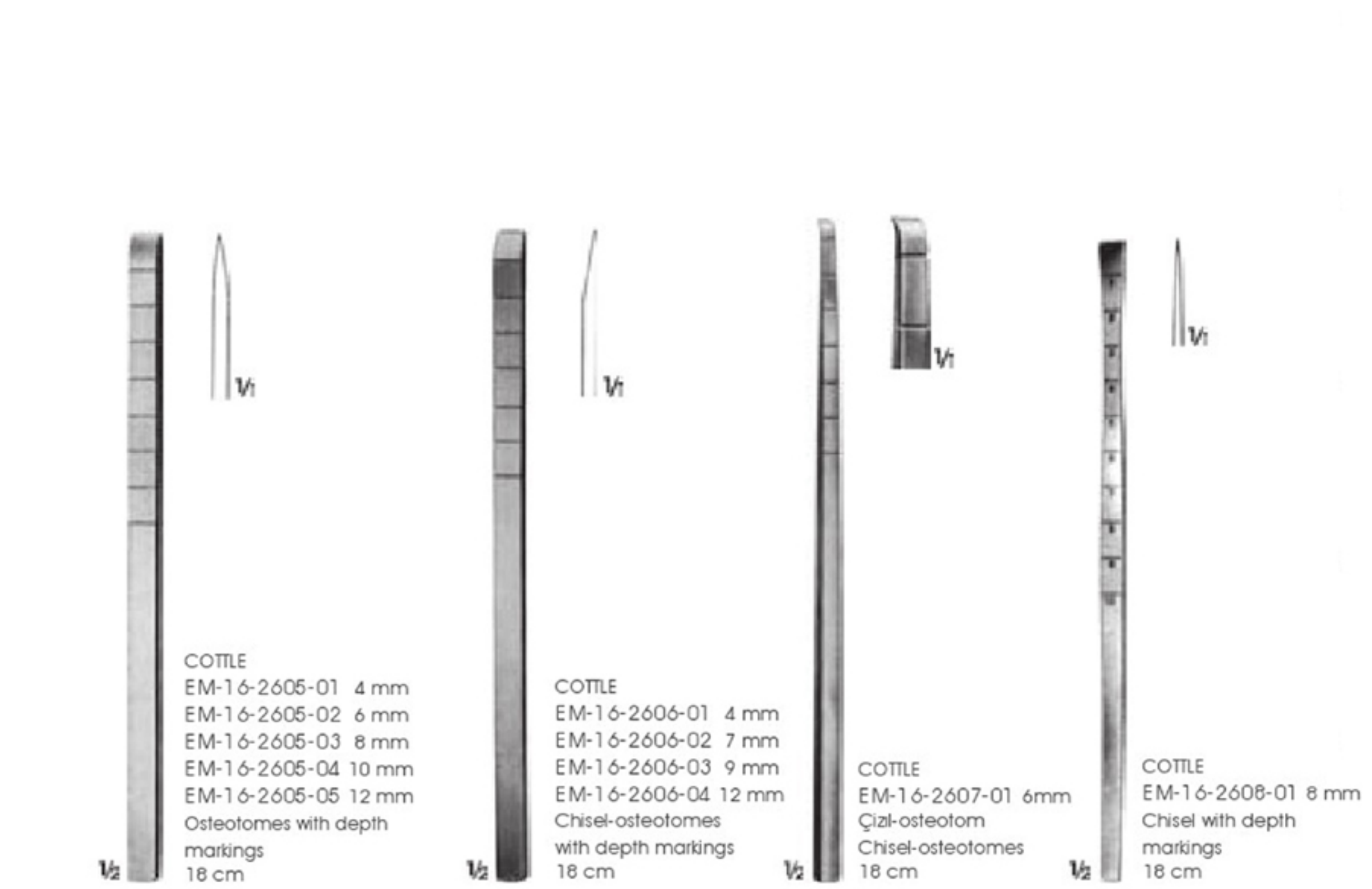
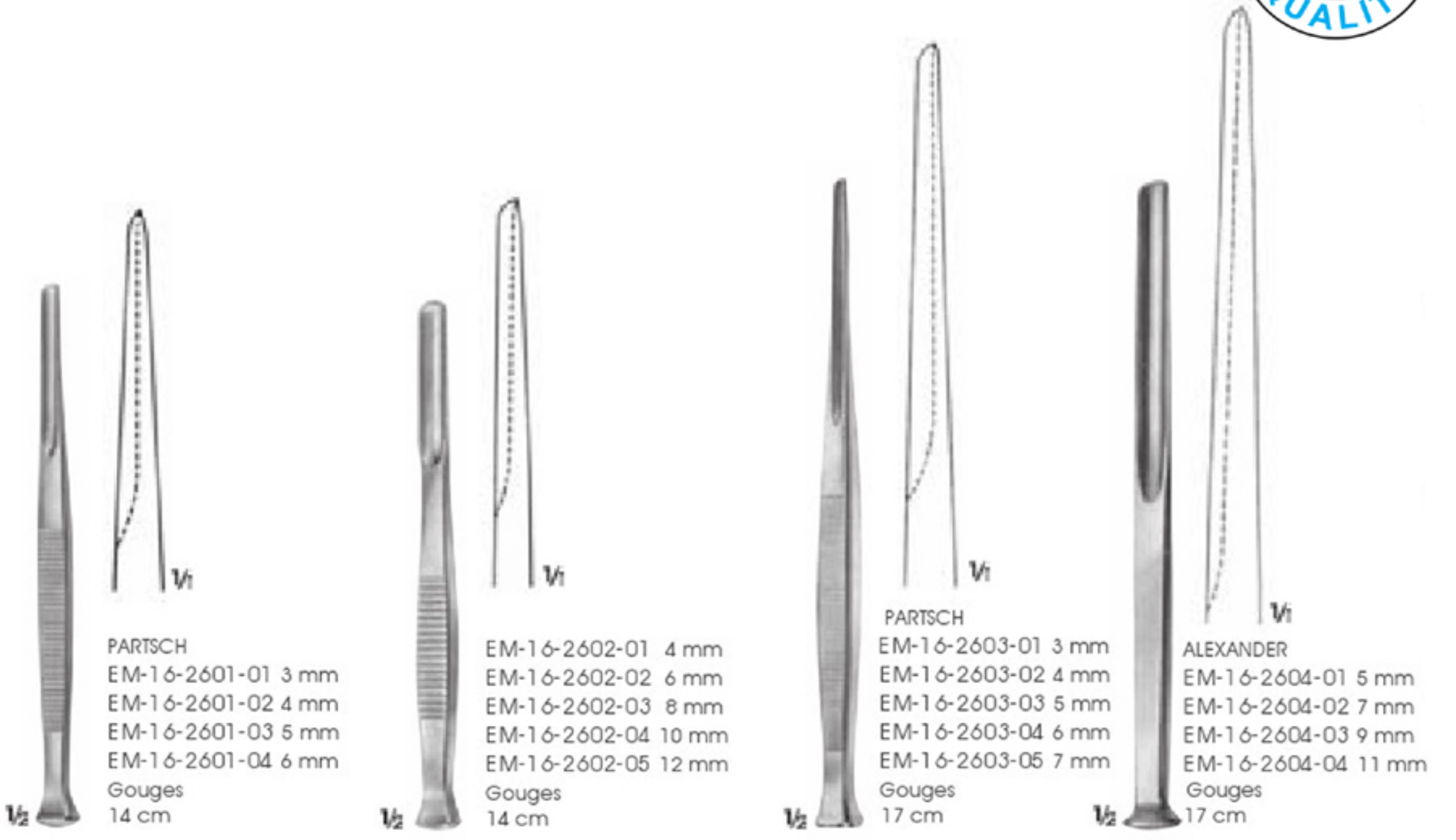

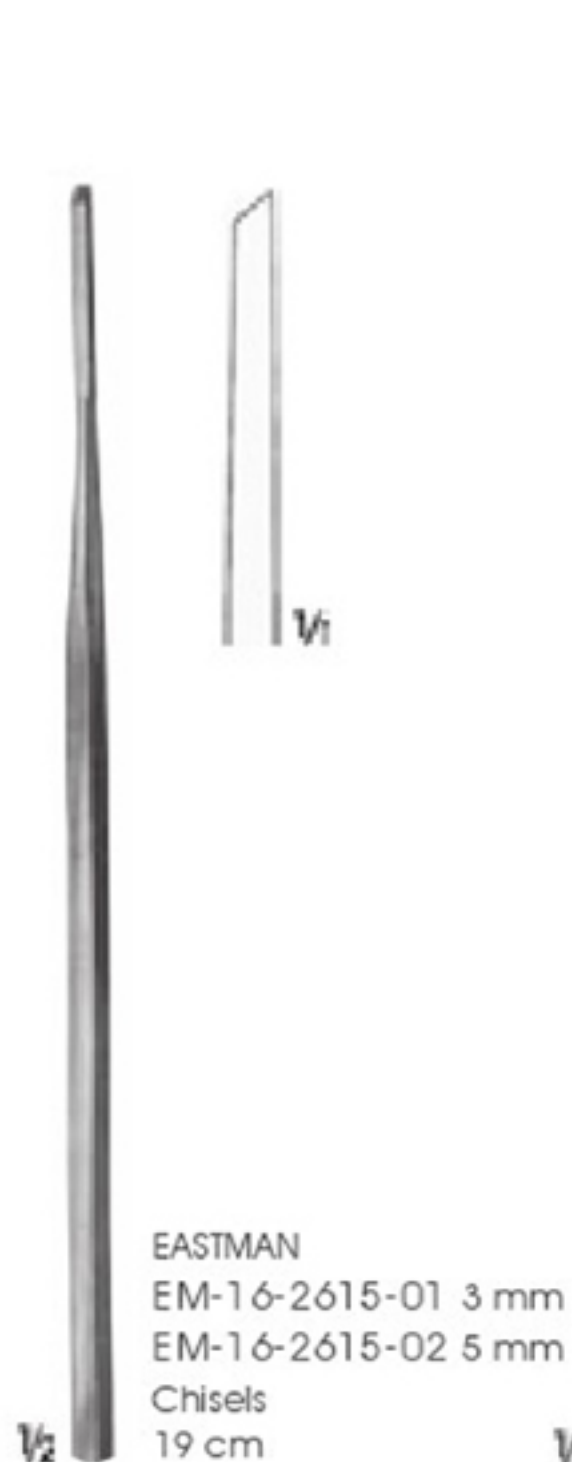
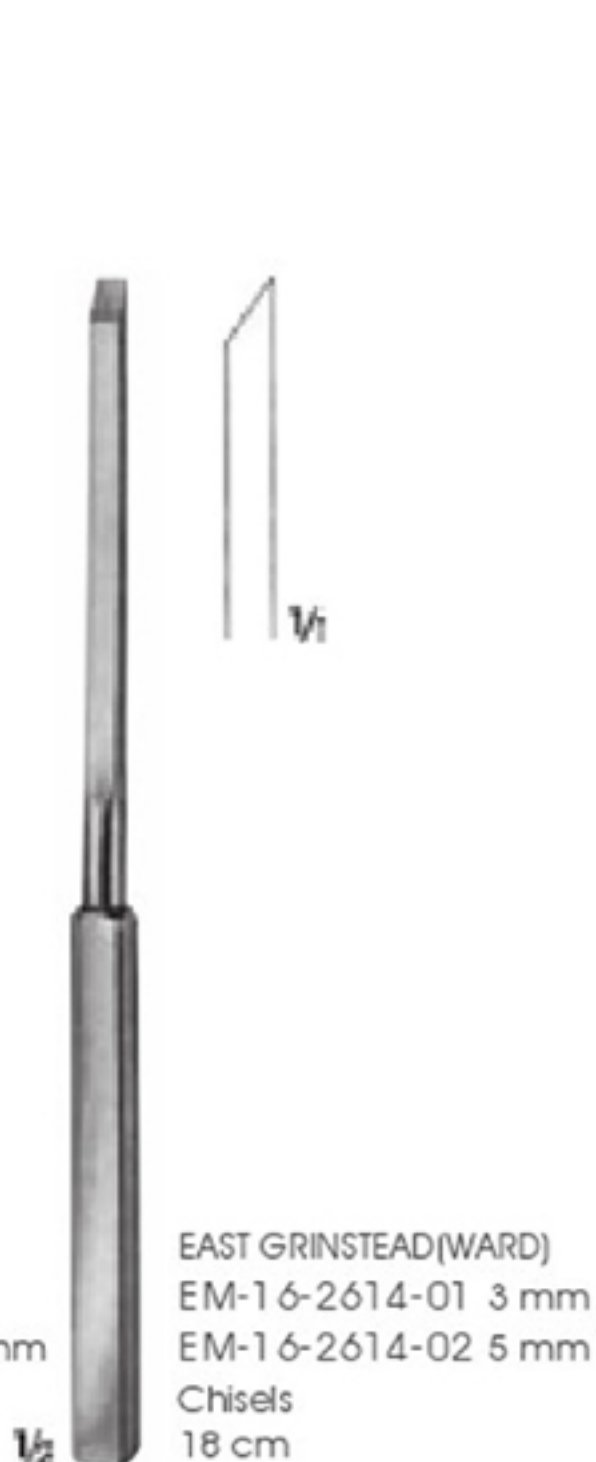
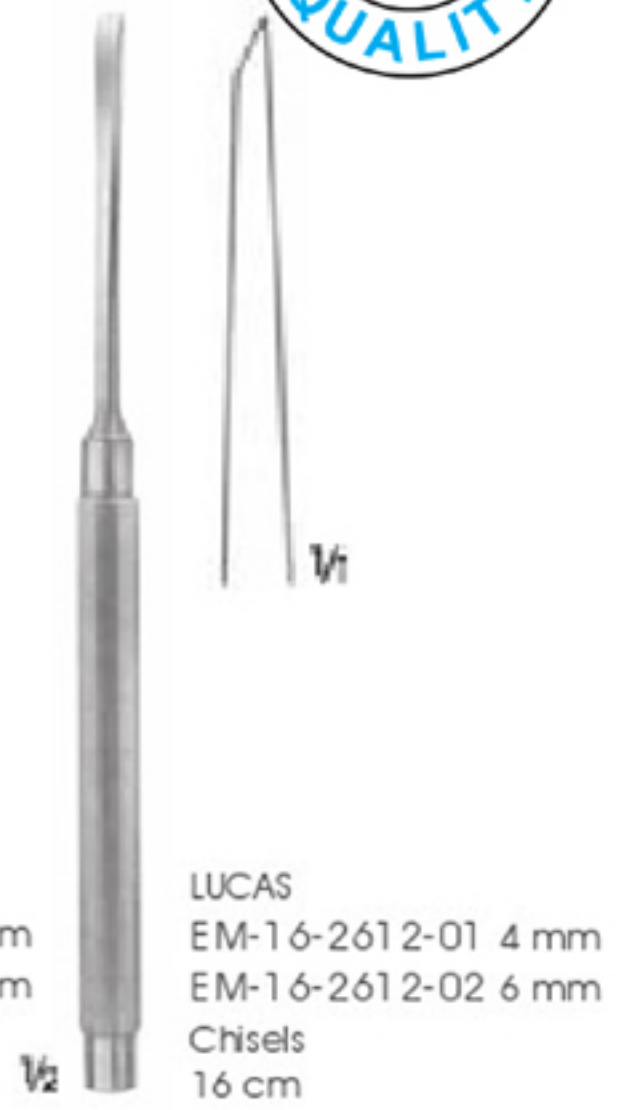
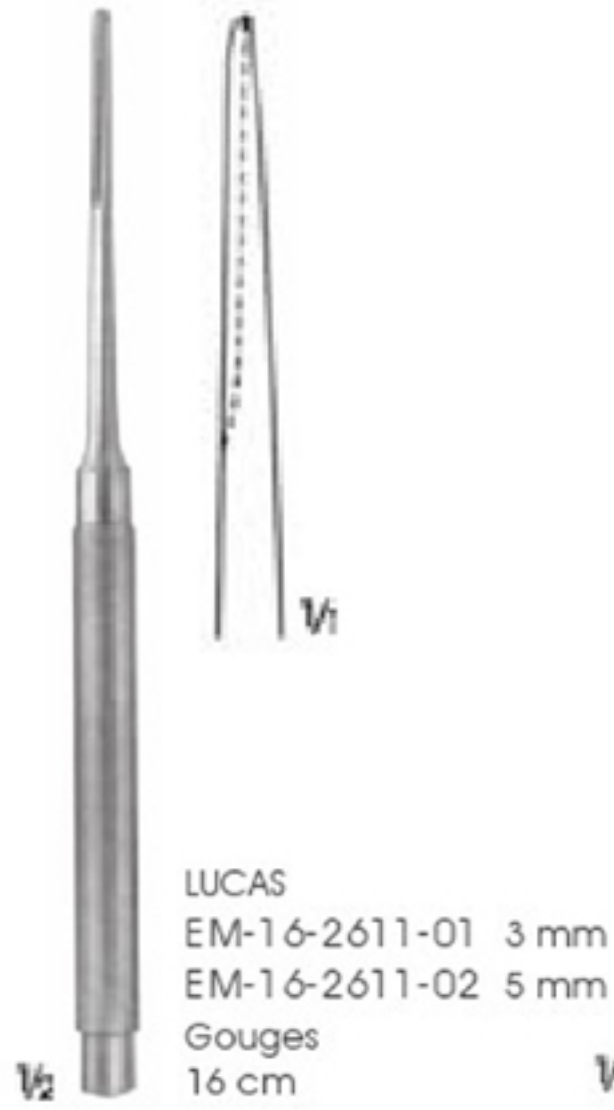
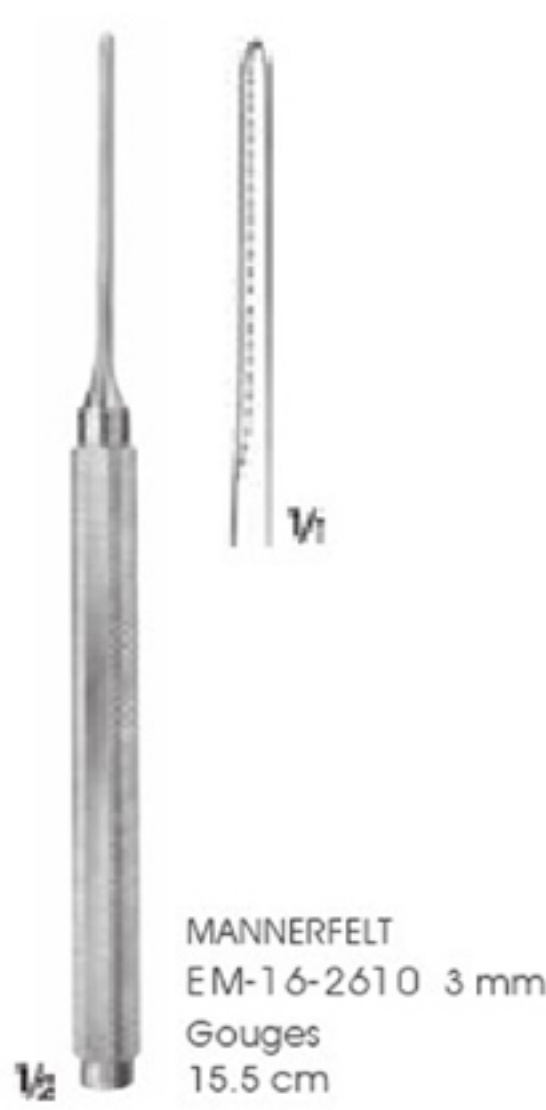

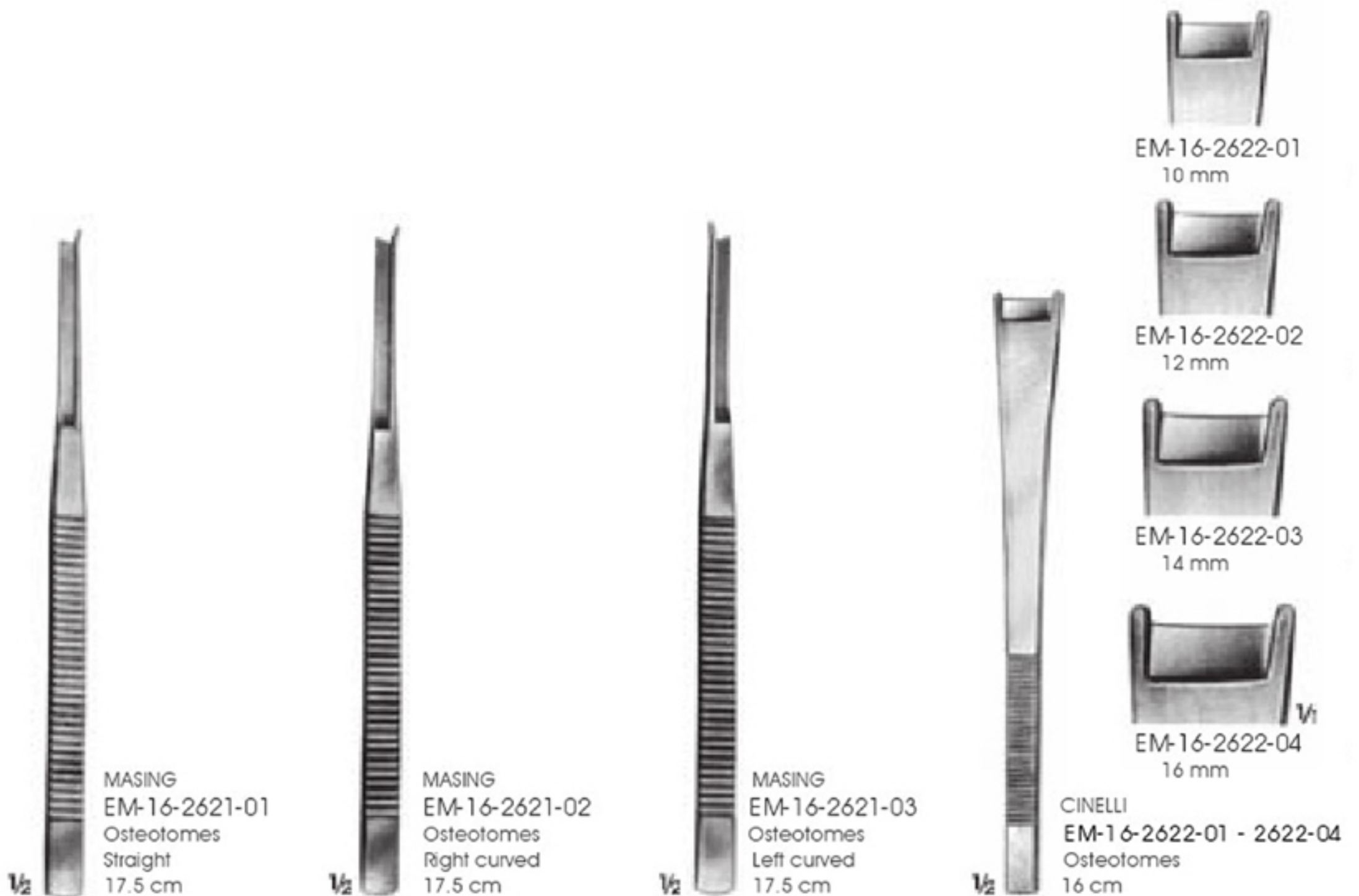
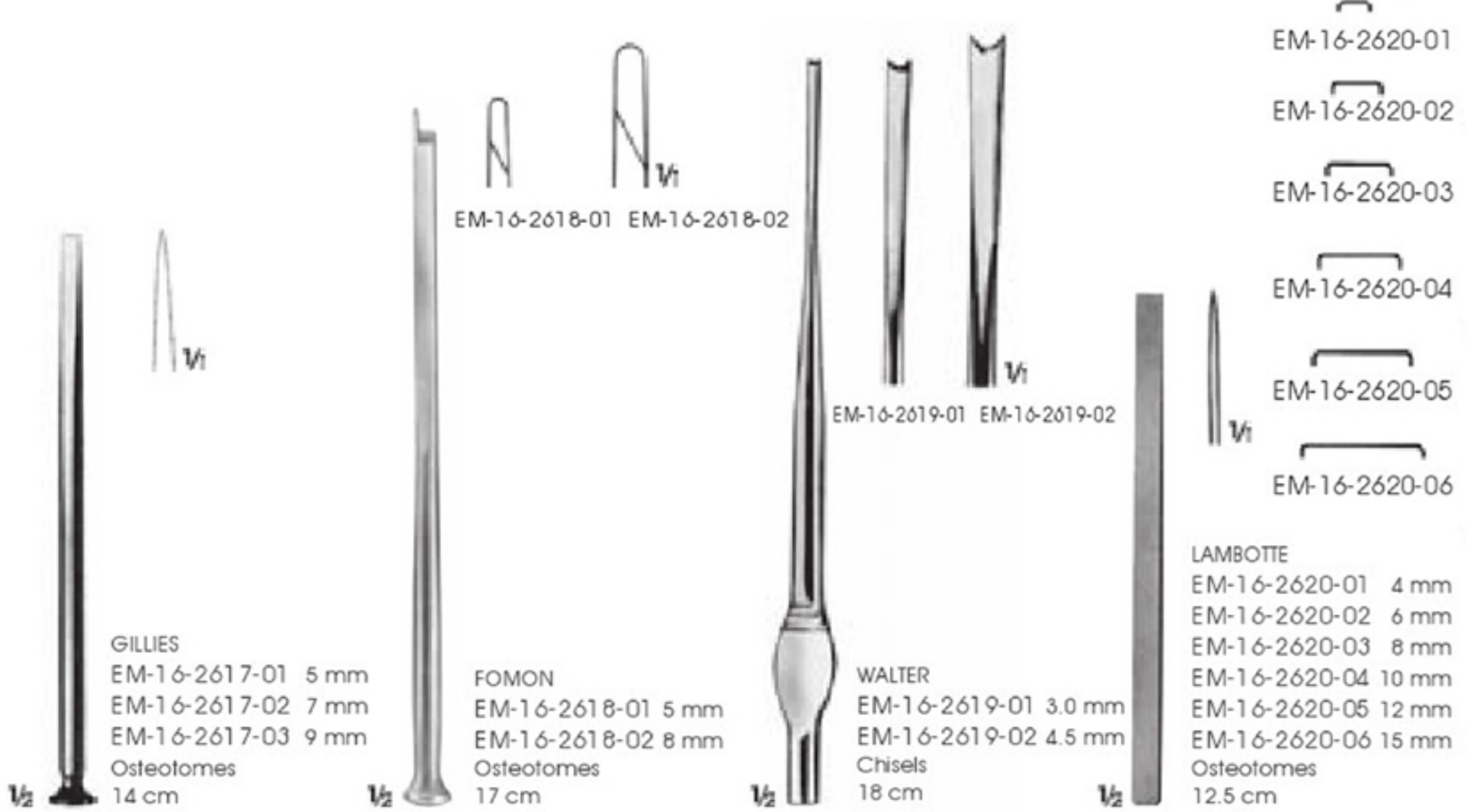

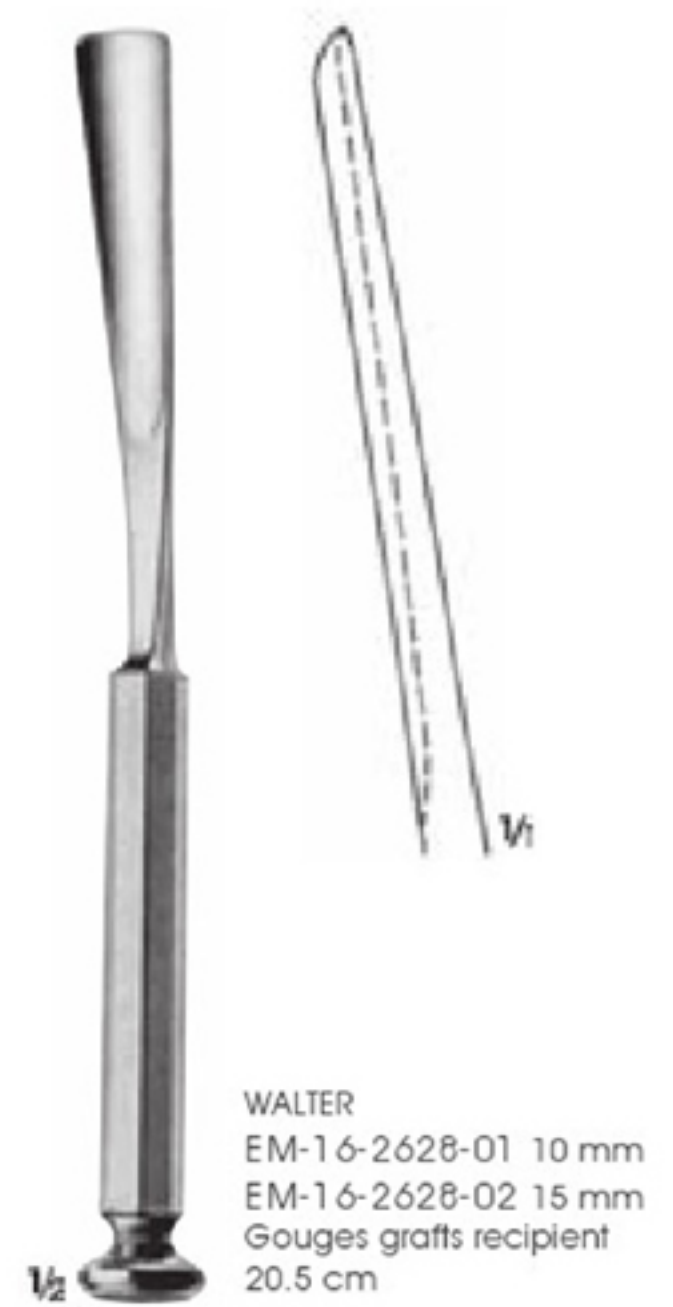
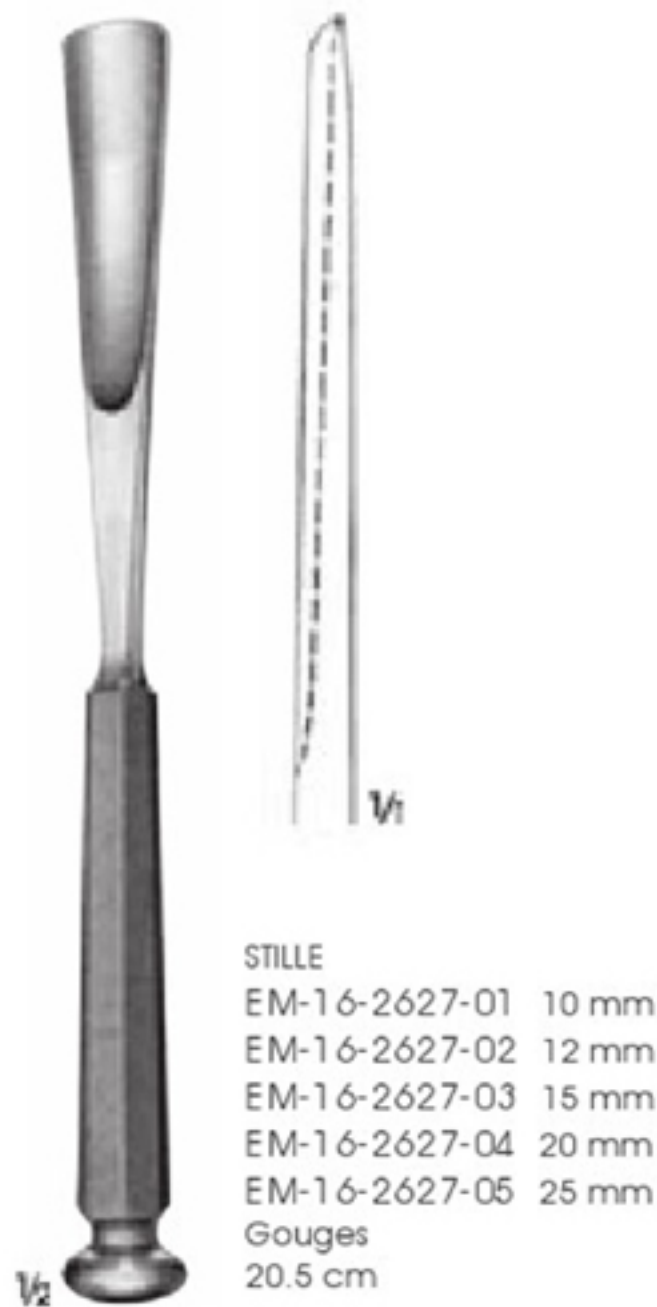
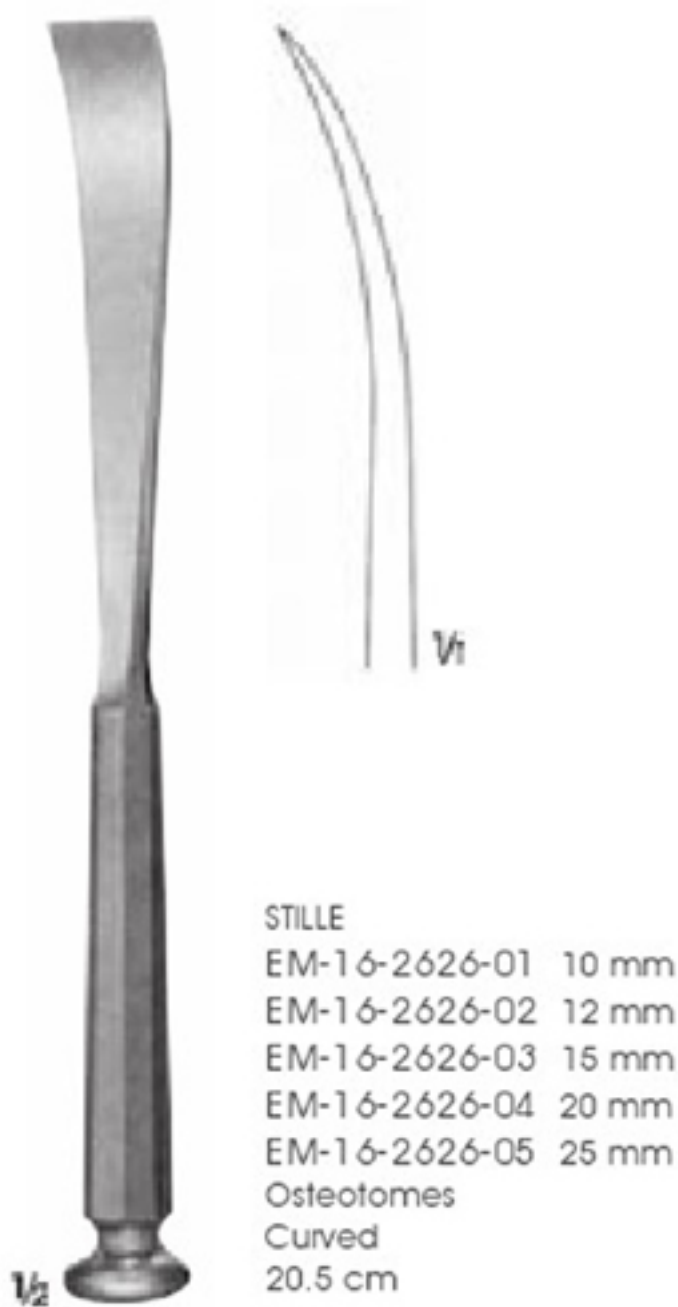
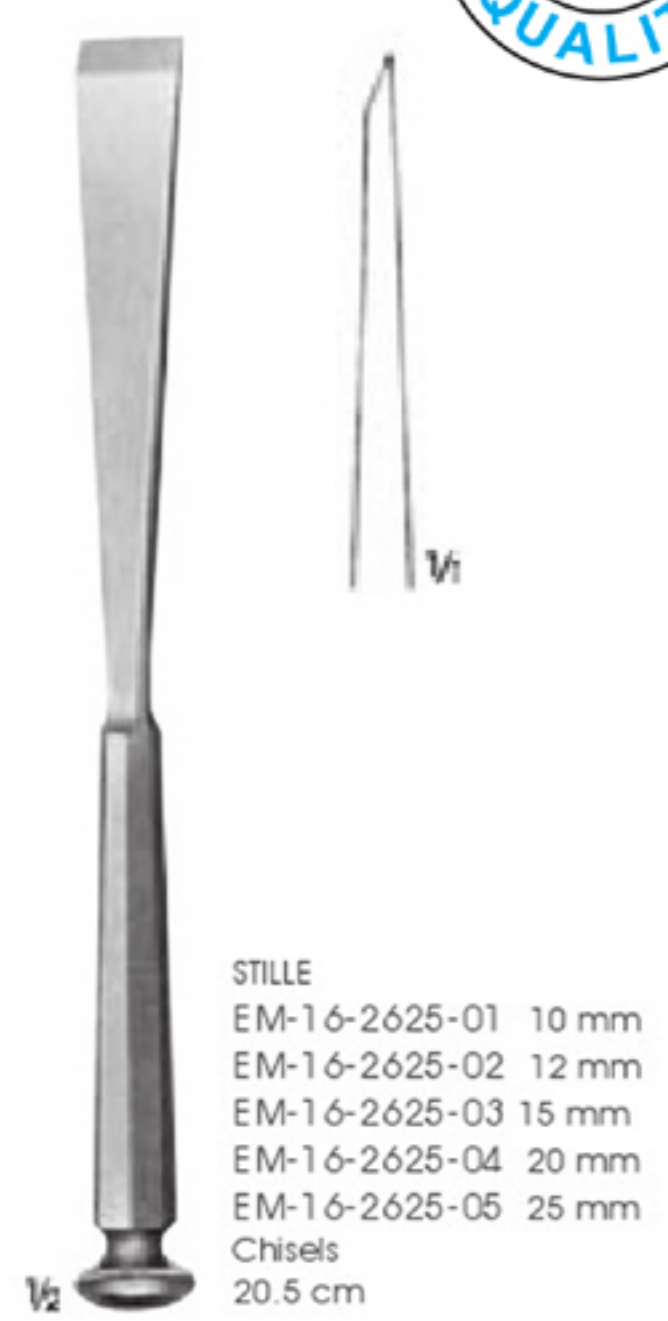
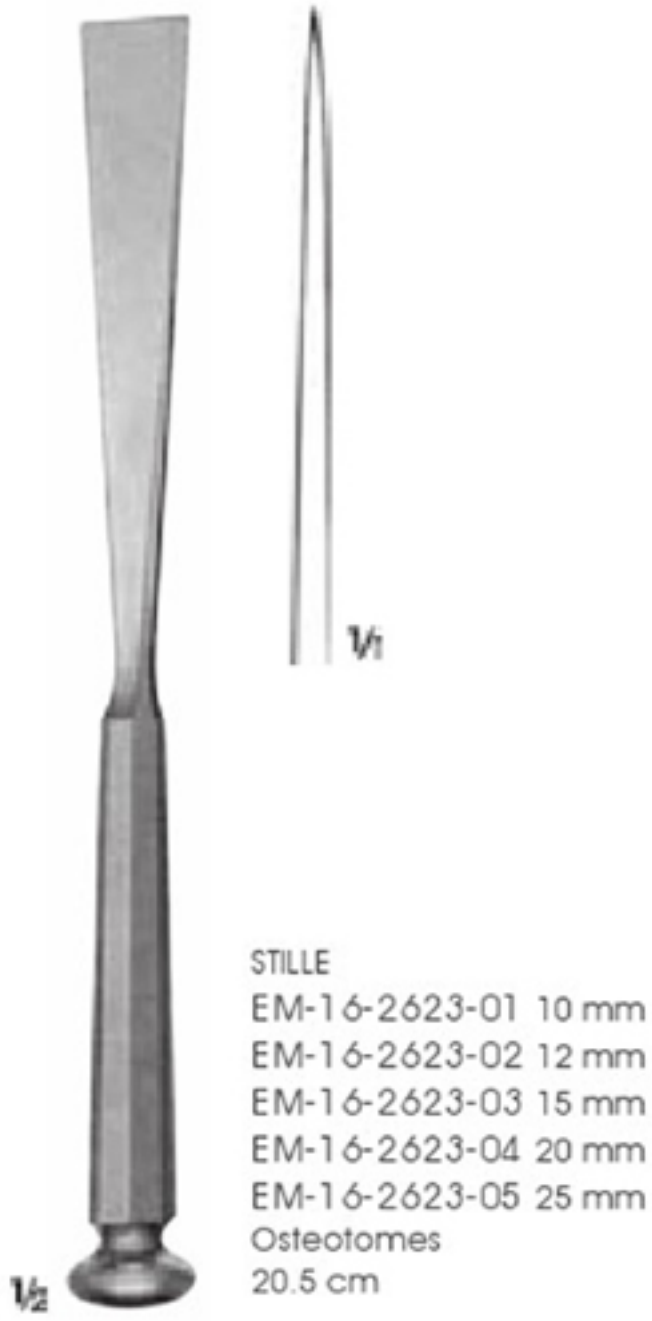

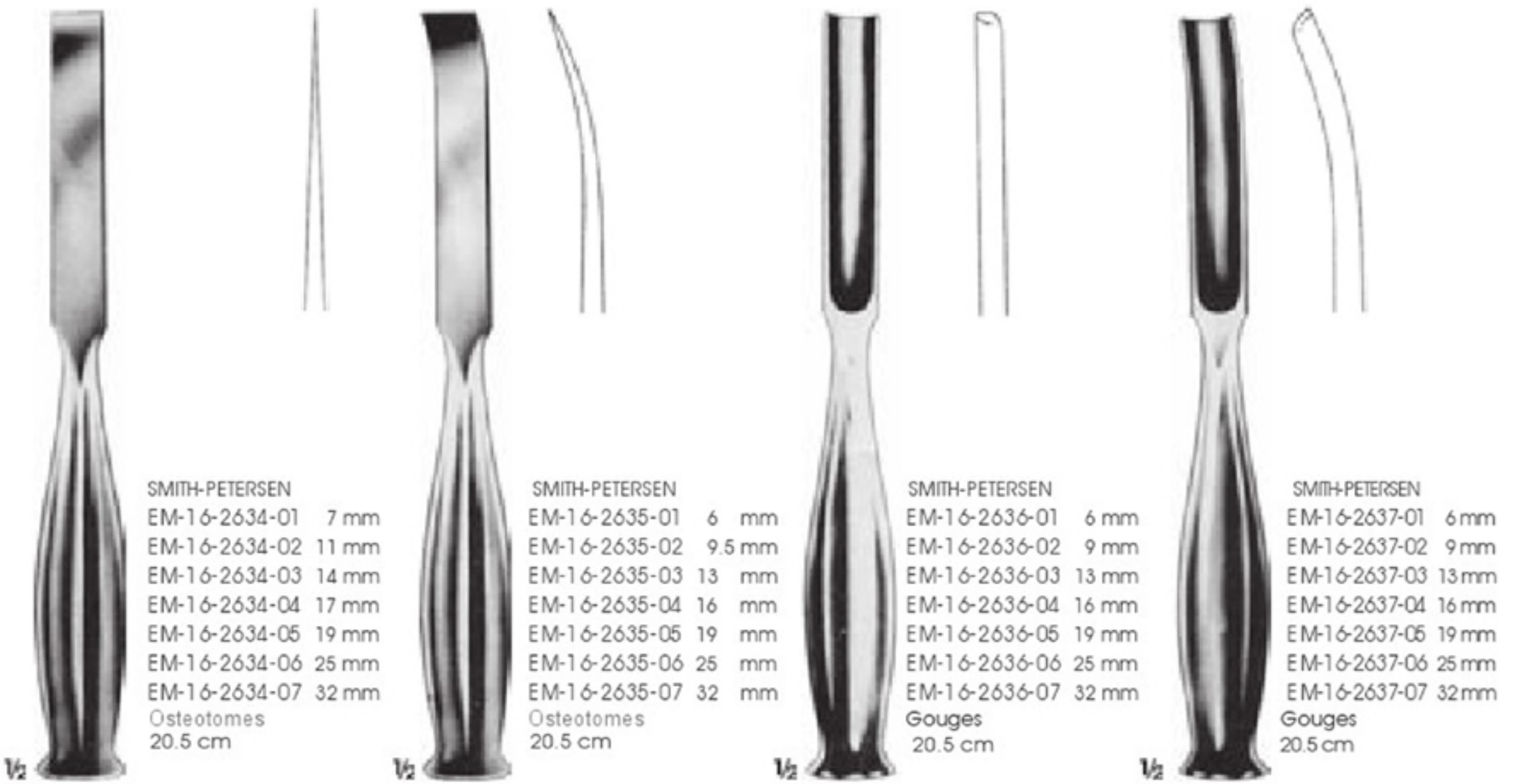
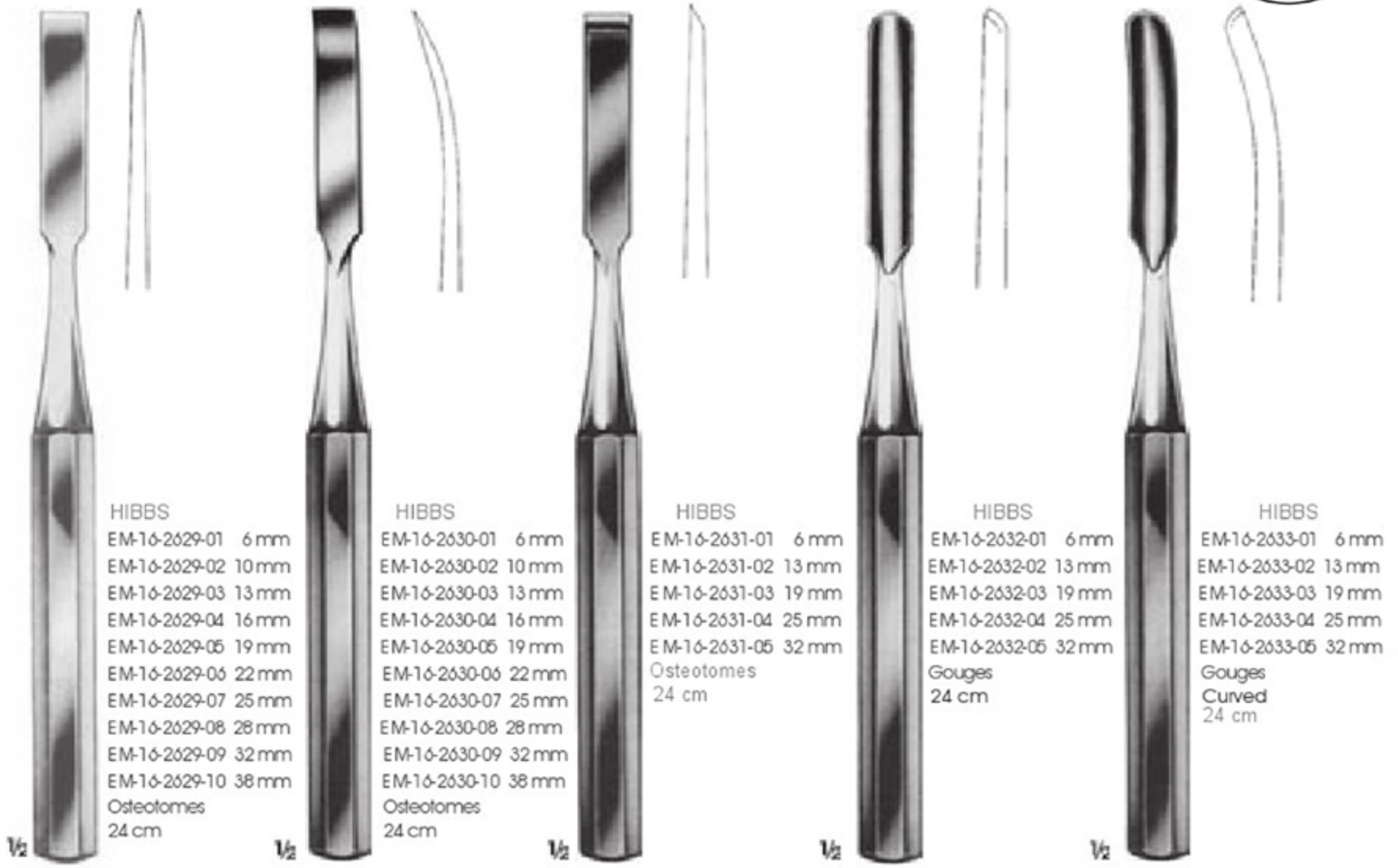



<p>LAMBOTTE</p> <p>EM-16-2638-01 4 mm</p> <p>EM-16-2638-02 8 mm</p> <p>EM-16-2638-03 10 mm</p> <p>EM-16-2638-04 13 mm</p> <p>EM-16-2638-05 15 mm</p> <p>EM-16-2638-06 18 mm</p> <p>EM-16-2638-07 20 mm</p> <p>EM-16-2638-08 25 mm</p> <p>EM-16-2638-09 30 mm</p> <p>EM-16-2638-10 38 mm</p> <p>EM-16-2638-11 44 mm</p> <p>EM-16-2638-12 50 mm</p> <p>Osteotomes Curved 24.5 cm</p>	<p>LAMBOTTE</p> <p>EM-16-2639-01 8 mm</p> <p>EM-16-2639-02 13 mm</p> <p>EM-16-2639-03 18 mm</p> <p>EM-16-2639-04 25 mm</p> <p>EM-16-2639-05 30 mm</p> <p>EM-16-2639-07 38 mm</p> <p>Osteotomes Curved 24.5 cm</p>	<p>NIEDERDELLMANN</p> <p>EM-16-2640-01 8 mm</p> <p>EM-16-2640-02 10 mm</p> <p>Osteotomes Curved 25 cm</p>	<p>OBWEGESER</p> <p>EM-16-2641-01 11 mm</p> <p>Osteotome Curved 23.5 cm</p>
--	---	---	---



Can be sterilized in a steam sterilizer up to 143°

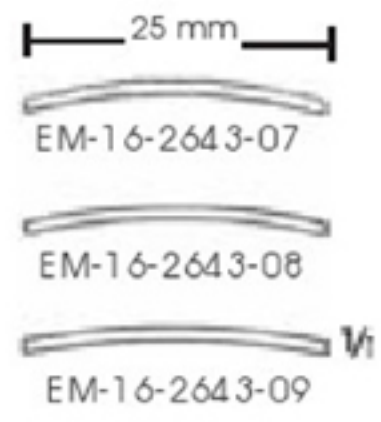

EM-16-2643-01
Changeable blades,
chisel
(EM-16-2642 with key)



EM-16-2643-02 5 mm

EM-16-2643-03 10 mm

EM-16-2643-04 16 mm

EM-16-2643-05 25 mm

length 45 mm



EM-16-2643-06 25 mm

length 78 mm



EM-16-2643-07 50 mm

EM-16-2643-08 60 mm

EM-16-2643-09 70 mm



Can be sterilized in a steam sterilizer up to 143°



EM-1 6-2644-01 10 mm
 EM-1 6-2644-02 15 mm
 EM-1 6-2644-03 20 mm
 Chisels
 20 cm



EM-1 6-2645-01 10 mm
 EM-1 6-2645-02 15 mm
 EM-1 6-2645-03 20 mm
 Chisels, curved
 20 cm



LEXER-MINI
 EM-1 6-2646-01 4 mm
 EM-1 6-2646-02 6 mm
 EM-1 6-2646-03 8 mm
 EM-1 6-2646-04 10 mm
 EM-1 6-2646-05 12 mm
 Osteotomes
 18 cm



LEXER-MINI
 EM-1 6-2647-01 4 mm
 EM-1 6-2647-02 6 mm
 EM-1 6-2647-03 8 mm
 EM-1 6-2647-04 10 mm
 EM-1 6-2647-05 12 mm
 Gouges
 18 cm



LEXER
 EM-1 6-2648-01 5 mm
 EM-1 6-2648-02 7 mm
 EM-1 6-2648-03 10 mm
 EM-1 6-2648-04 15 mm
 EM-1 6-2648-05 20 mm
 EM-1 6-2648-06 25 mm
 EM-1 6-2648-07 30 mm
 Osteotomes
 22 cm



LEXER
 EM-1 6-2649-01 5 mm
 EM-1 6-2649-02 7 mm
 EM-1 6-2649-03 10 mm
 EM-1 6-2649-04 15 mm
 EM-1 6-2649-05 20 mm
 EM-1 6-2649-06 25 mm
 EM-1 6-2649-07 30 mm
 Gouges
 22 cm

Can be sterilized in a steam sterilizer up to 143°



$\frac{1}{2}$
EM-1 6-2650 9 mm
Broken screw extractor
gouges
22 cm

$\frac{1}{2}$
ZIELKE
EM-1 6-2651-01 5.5 mm
EM-1 6-2651-02 9.0 mm
Gouges for scoliosis operations
23 cm

$\frac{1}{2}$
EM-1 6-2652-01 5 mm
EM-1 6-2652-02 10 mm
EM-1 6-2652-03 15 mm
Spongiosa gouges, curved
25 cm

$\frac{1}{2}$
LEXER
EM-1 6-2653
Spongiosa gouges
28 cm

Can be sterilized in a steam sterilizer up to 143°

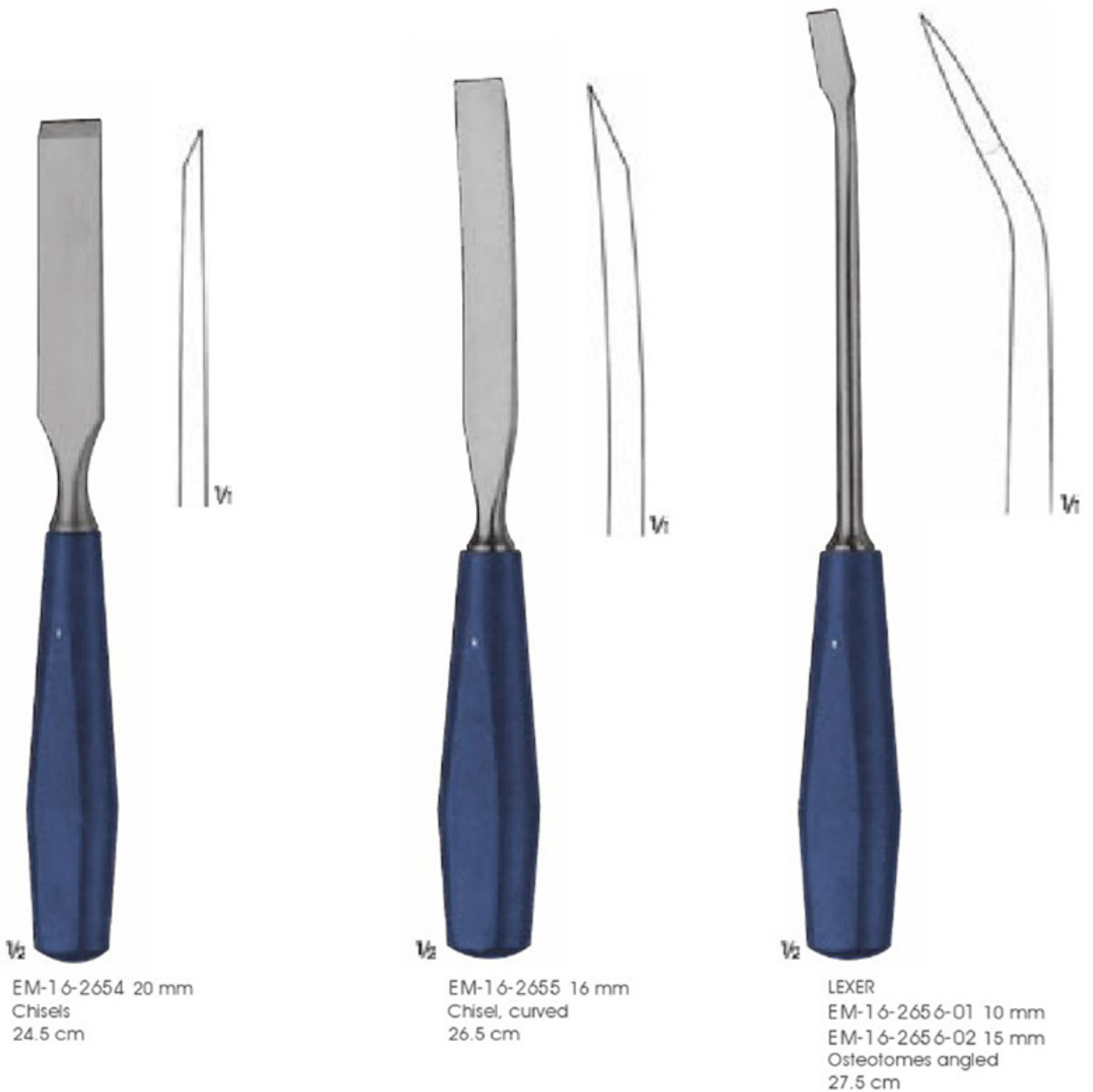

Can be sterilized in a steam sterilizer up to 143°

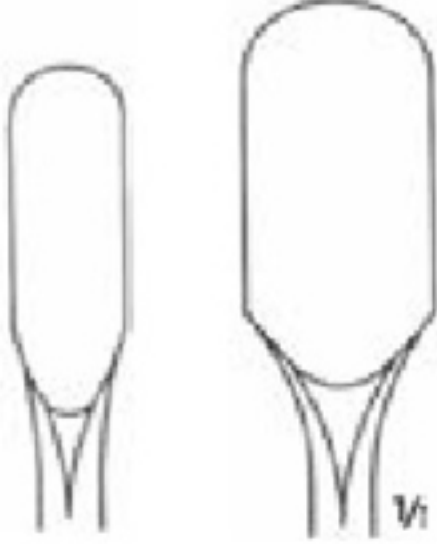
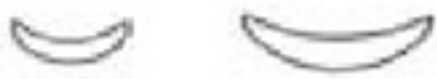

EM-16-2657-01 9 mm
EM-16-2657-02 15 mm



EM-16-2658-01 9 mm
EM-16-2658-02 15 mm



EM-16-2659-01 9 mm
EM-16-2659-02 15 mm

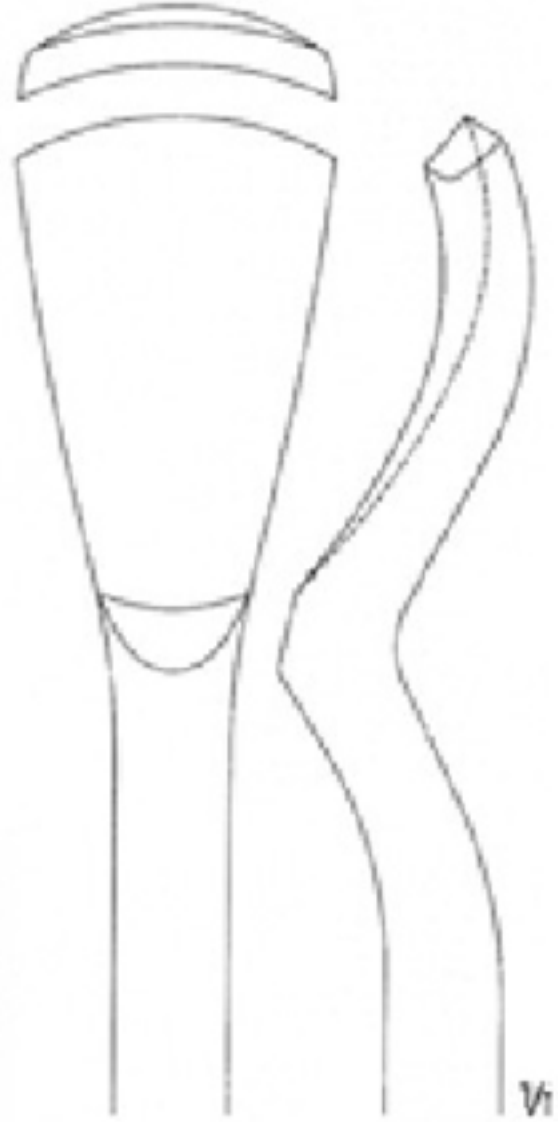

25 mm

WAGNER
EM-16-2657-01 - 2657-02
EM-16-2658-01 - 2658-02
EM-16-2659-01 - 2659-02
34 cm

EM-16-2660
29 cm

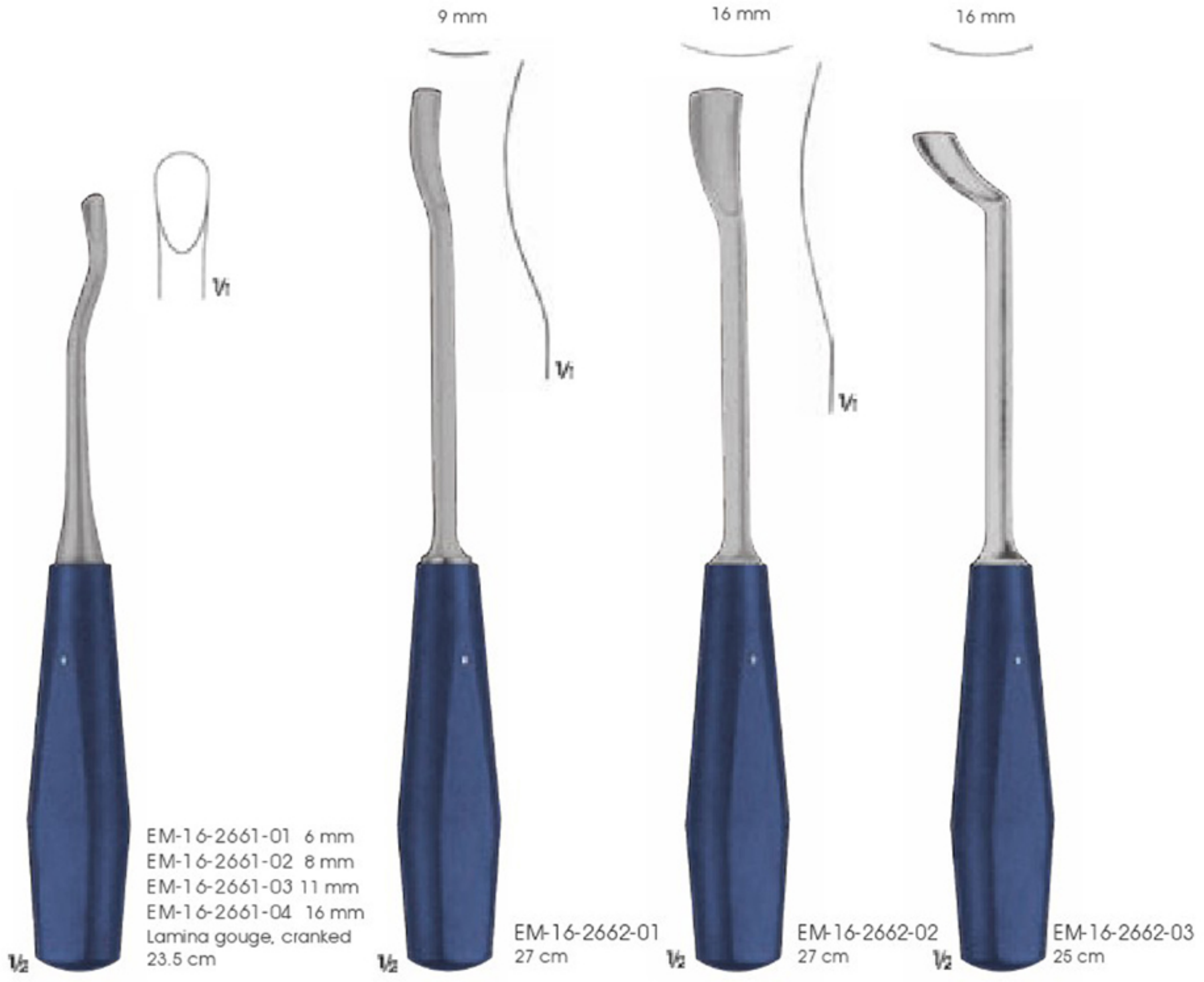



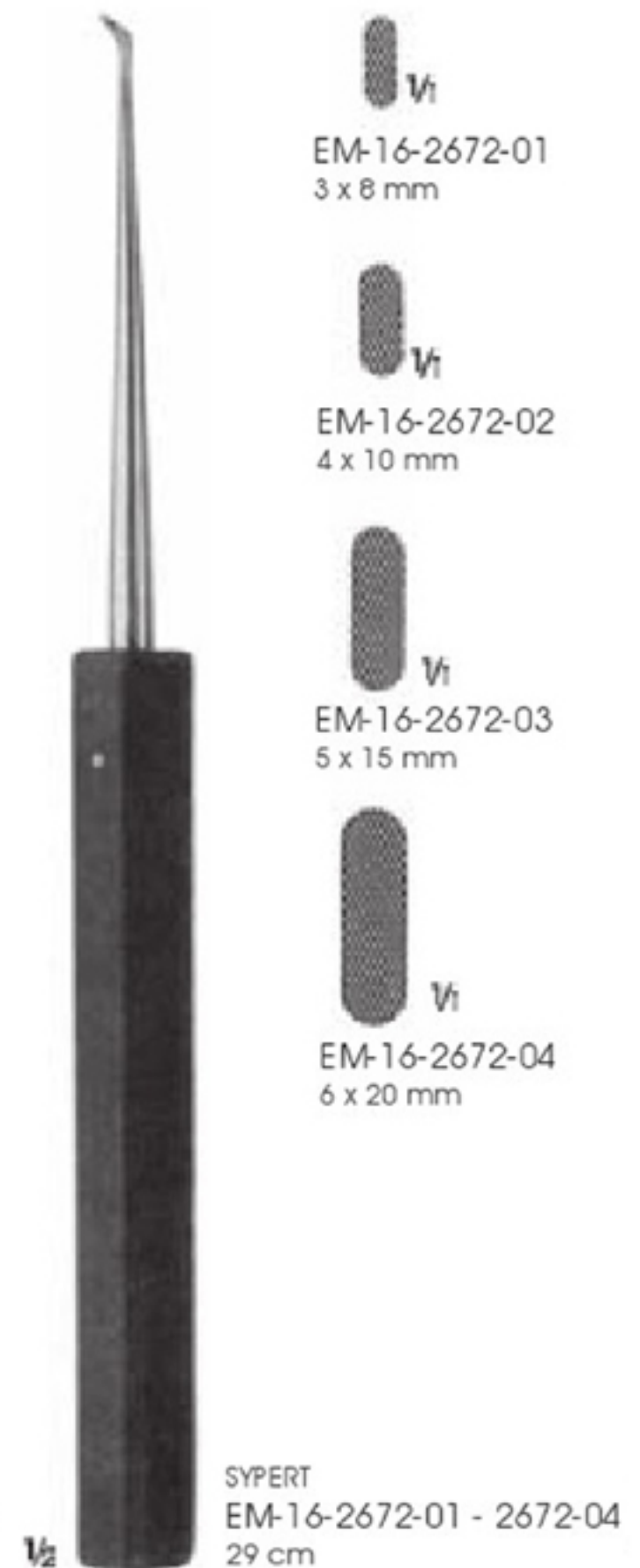
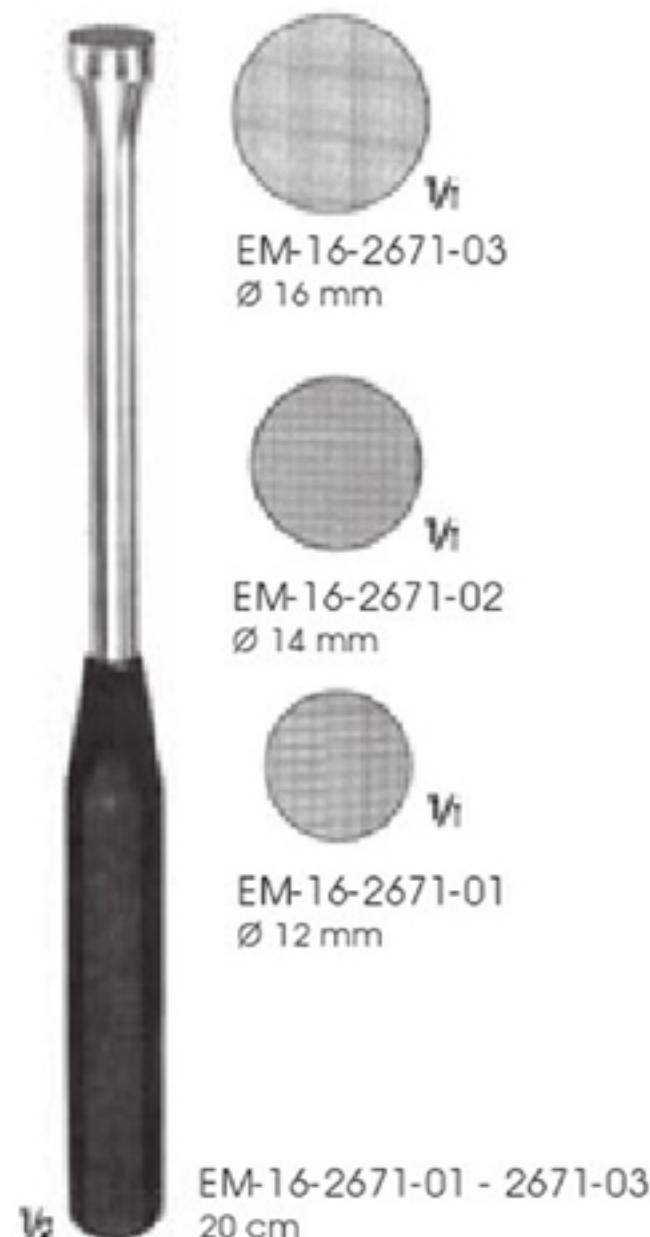

Weights refer to heads of the mallets



Weights refer to heads of the mallets



Ø 20 mm

MEAD
EM-16-2679-01 180 gr
Plastic disc
19 cm
EM-16-2679-02
Pair of spare disc

1/2



Ø 25 mm

EM-16-2680-01 135 gr
Plastic disc
18.5 cm
EM-16-2680-02
Pair of spare disc

1/2



Ø 30 mm

EM-16-2681-02
Pair of Spare discs

EM-16-2681-01 200 gr
Plastic discs
24.5 cm

1/2



Ø 35 mm

Mallet head without discs 125 gr

WAGNER
EM-16-2682-01 Complete
Metal disc EM-16-2682-02
Plastic disc EM-16-2682-03
Wrench EM-16-2682-04
23.5 cm

1/2

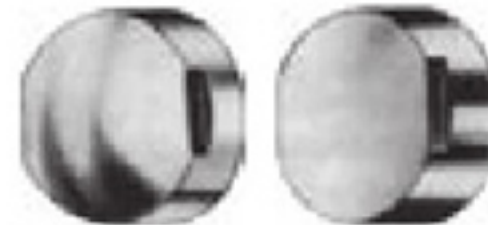

EM-16-2682-02 215 gr.
1 Metal disc, flat
1 Metal disc, convex

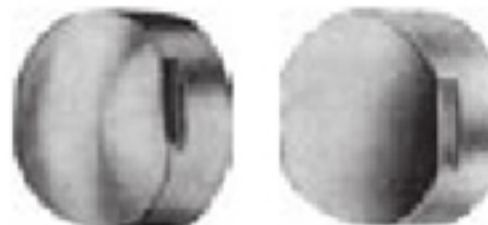

EM-16-2682-03 30 gr.
1 Plastic disc, flat
1 Plastic disc, convex



EM-16-2682-04
Wrench

Weights refer to heads of the mallets



COTTLE
EM-1 6-2683 235 gr
Bir taraft düz, bir taraft bombeli
Bir side flat, bir side convex
18.5cm



BERGMANN
EM-1 6-2685 245 gr
23.5 cm



OMBREDANNE
EM-1 6-2686 520 gr
24 cm

Weights refer to heads of the mallets

