

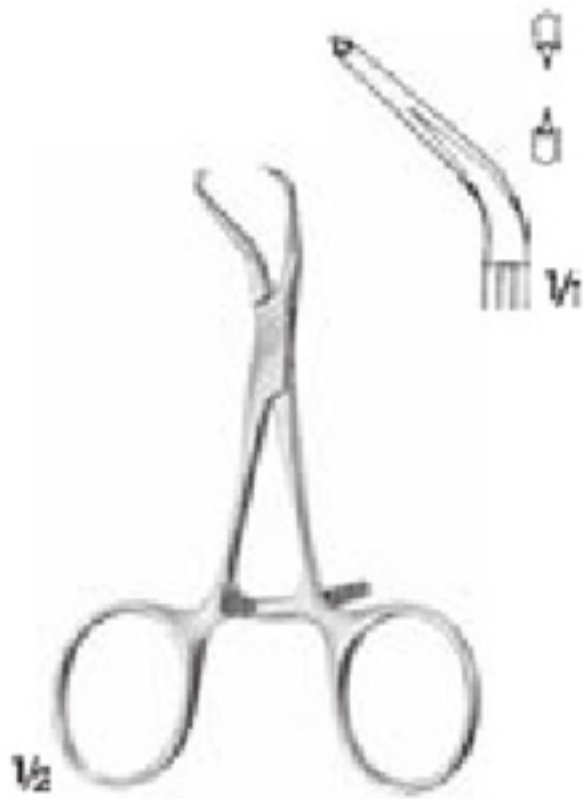

Bone Rongeurs And Punches

Knochen Rongeurs und Locher



EM-18-2774
 Reposition forceps with
 stepped tips
 9.5 cm



EM-18-2775
 konumlandırma pensi
 Reposition forceps for small
 fragments
 13.5 cm

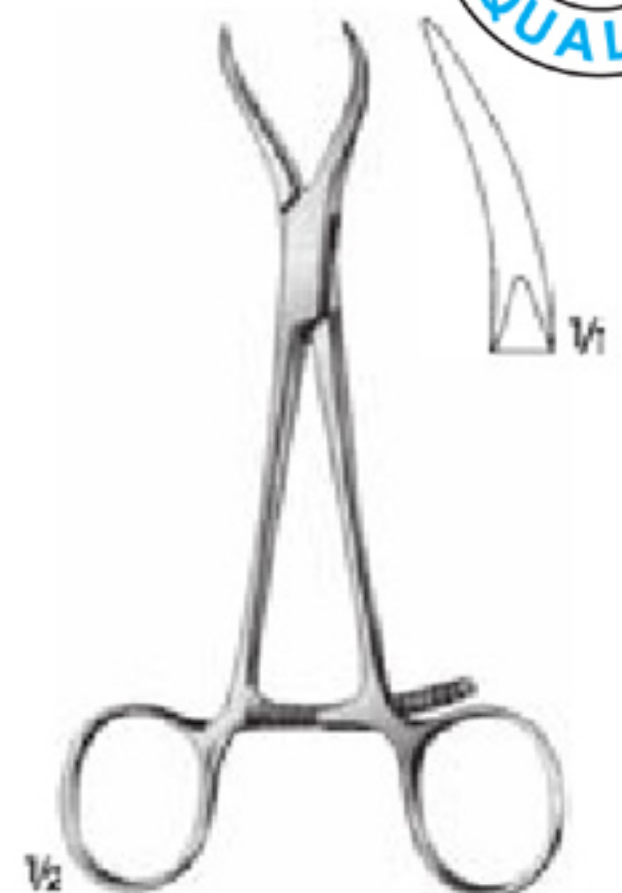

EM-18-2776
 konumlandırma pensi
 Reposition forceps, especially
 for maxillary reposition
 13.5 cm



HAASE
 EM-18-2777
 Reposition forceps for
 mandibular fractures
 16.5 cm

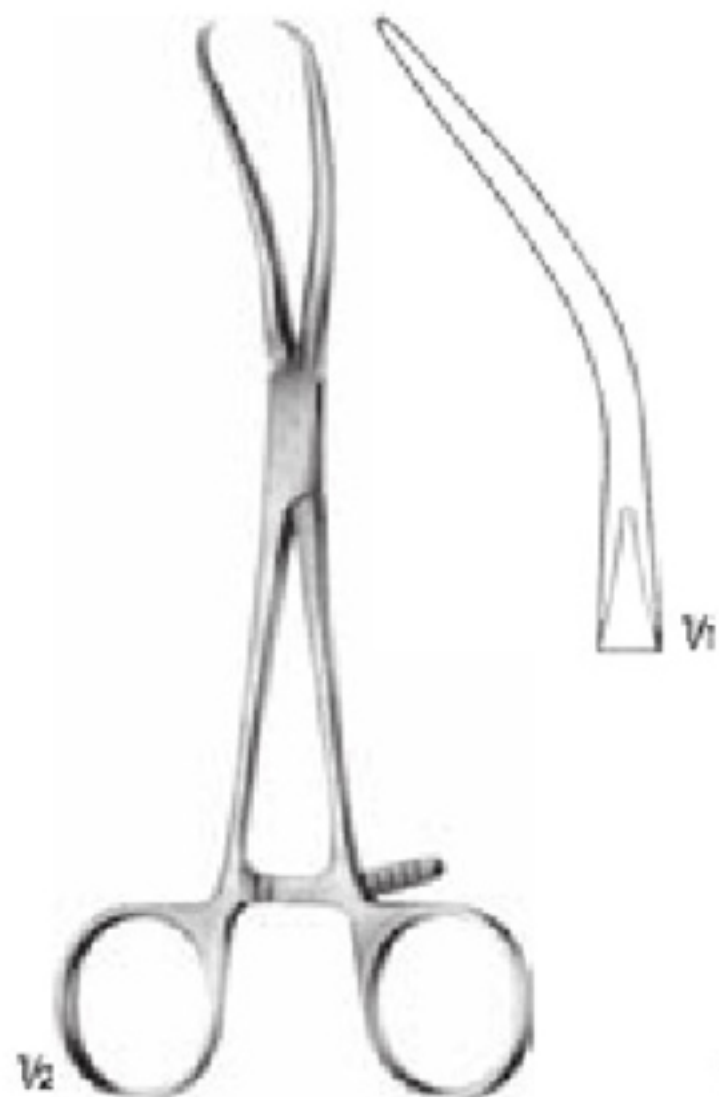

REILL
 EM-18-2778
 Reposition forceps
 17 cm

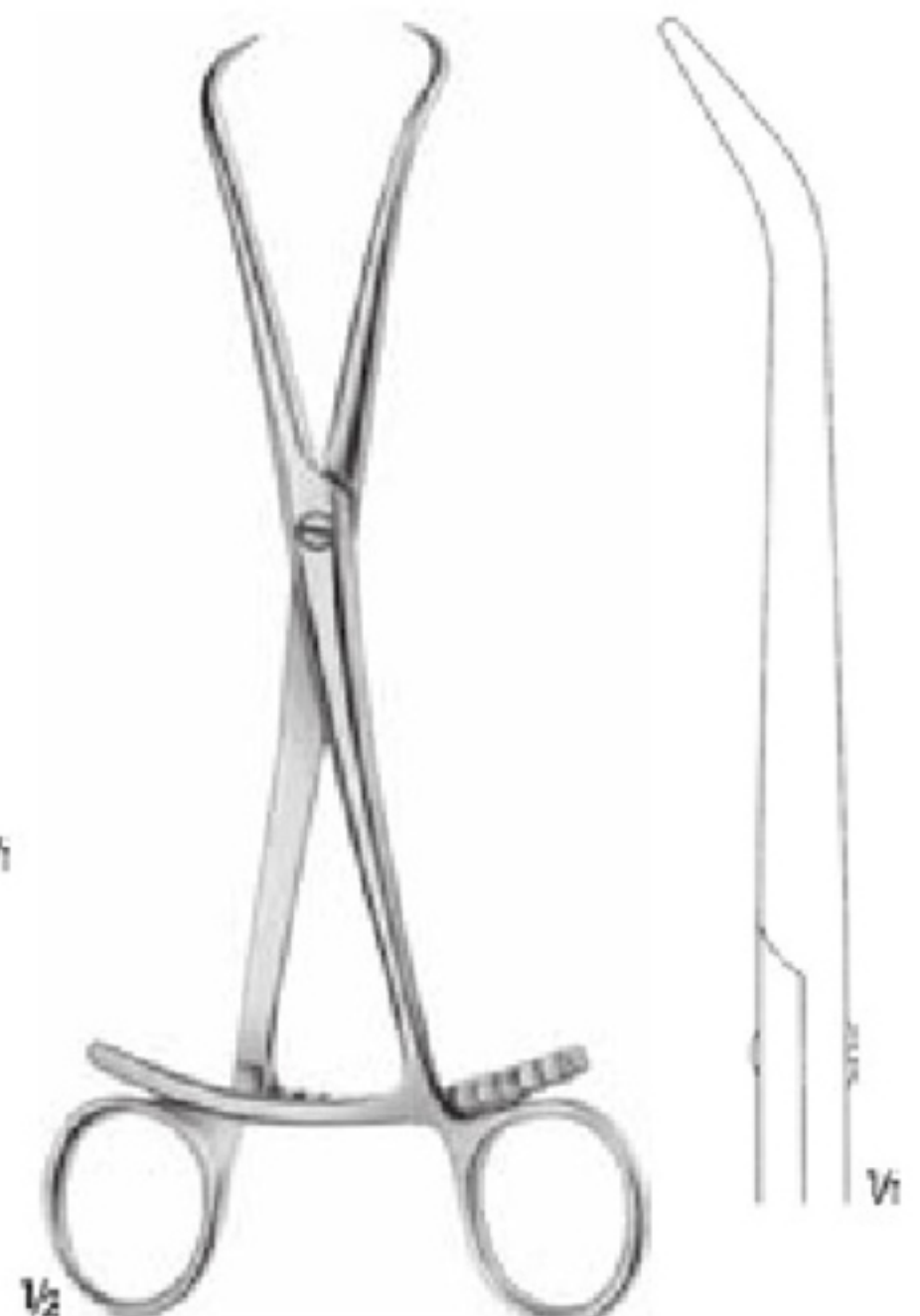

EM-18-2779
 Reposition forceps
 20.5 cm



FÖRSTNER
 EM-18-2780
 14 cm



EM-18-2781
 13.5 cm



HAASE
 EM-18-2782
 14 cm

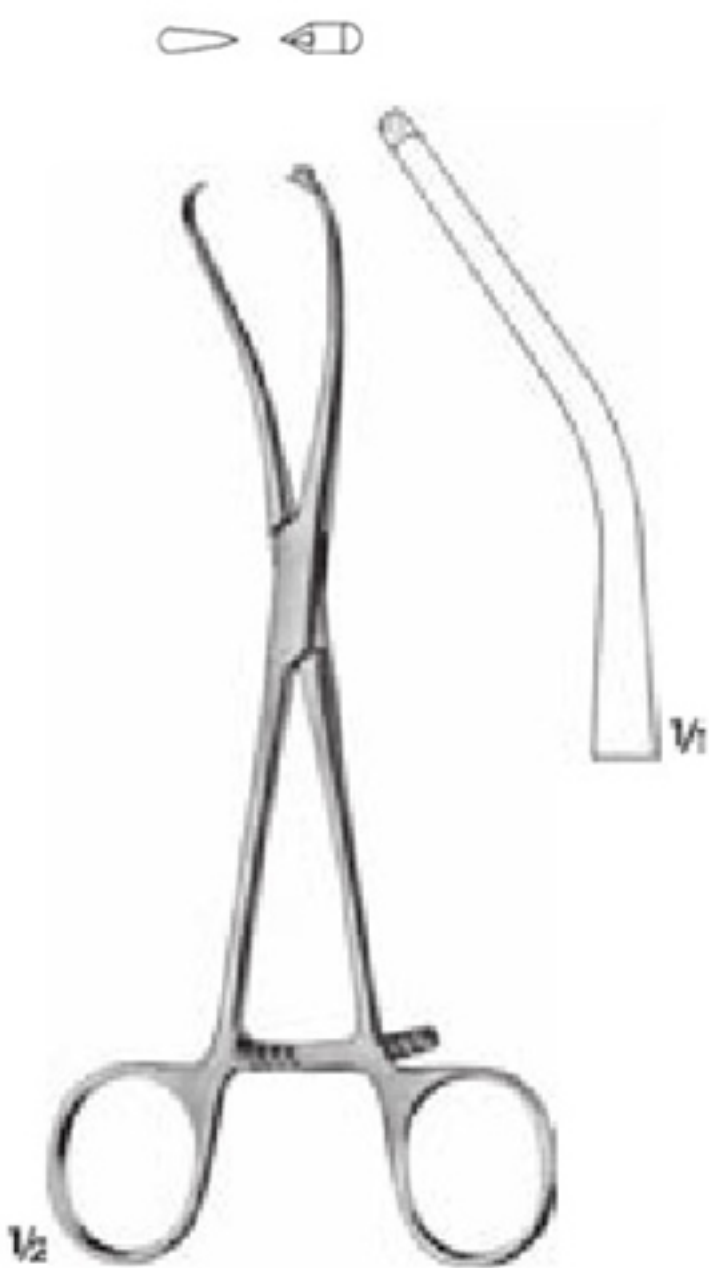

MEYER
 EM-18-2783
 Reposition forceps for fingers,
 with drill guide for KIRSCHNER
 For wires with \varnothing 1.0 mm
 17 cm

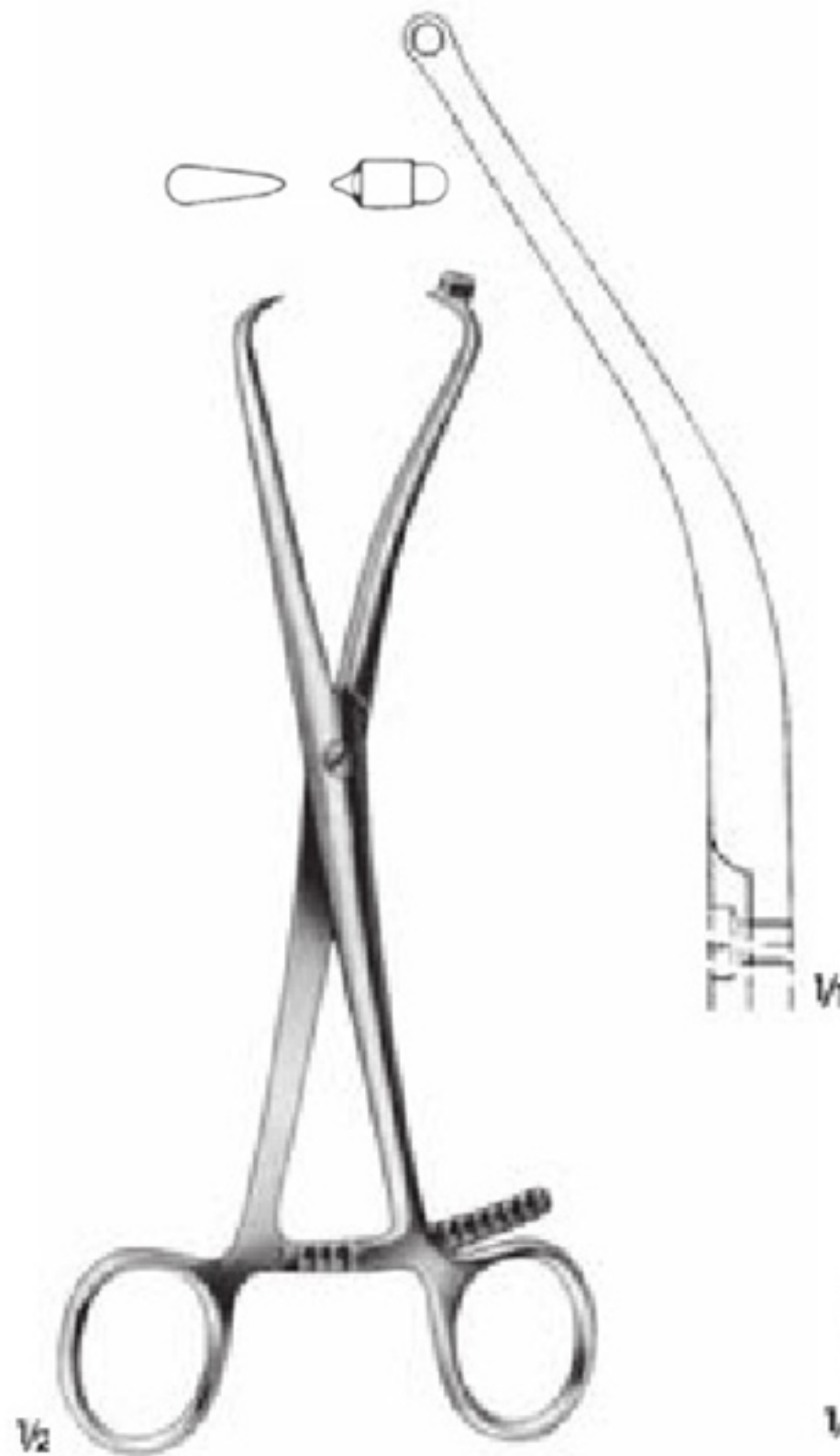

MEYER
 EM-18-2784
 Reposition forceps for fingers,
 with drill guide for KIRSCHNER
 For wires with \varnothing 2.0 mm
 20.5 cm

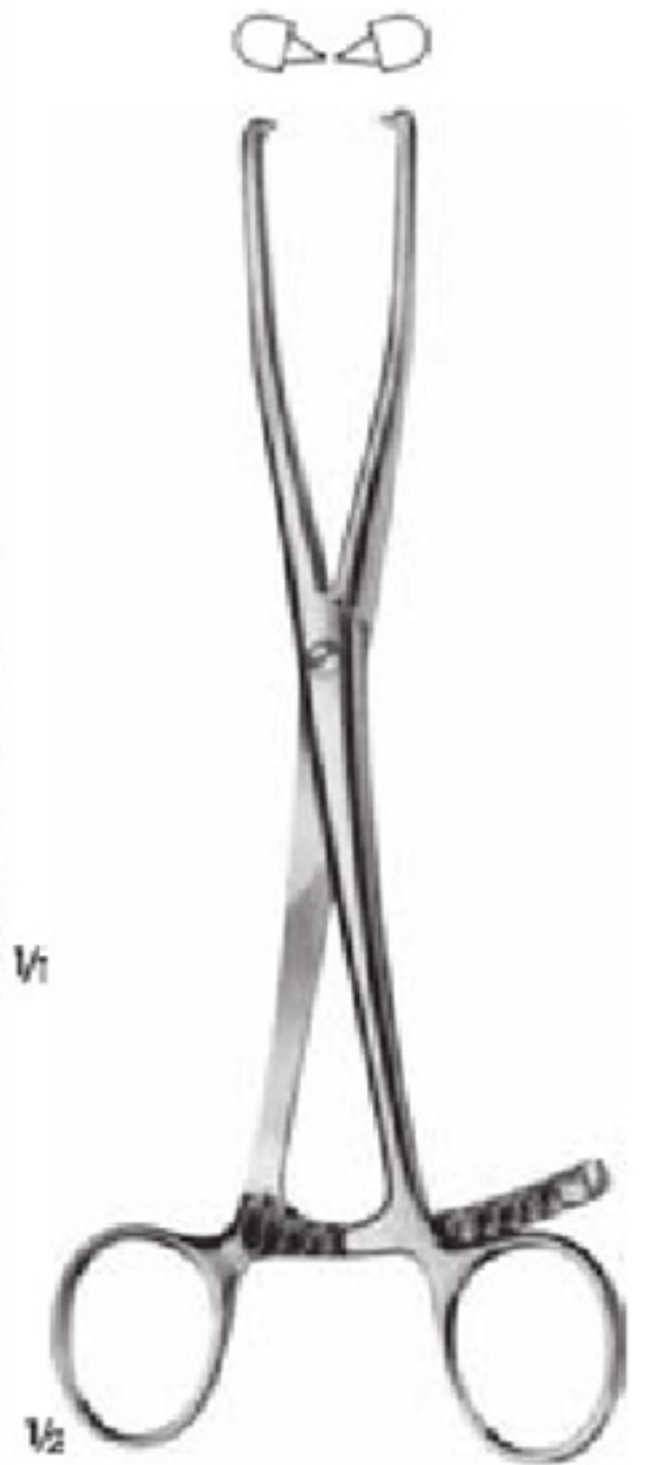

EM-18-2785
 Malleolar forceps
 21 cm



LEWIN
 EM-18-2786
 Bone clamp
 18.5 cm



EM-18-2787
 Patella forceps
 18.5 cm



EM-18-2788
 Sequestrum forceps
 20 cm

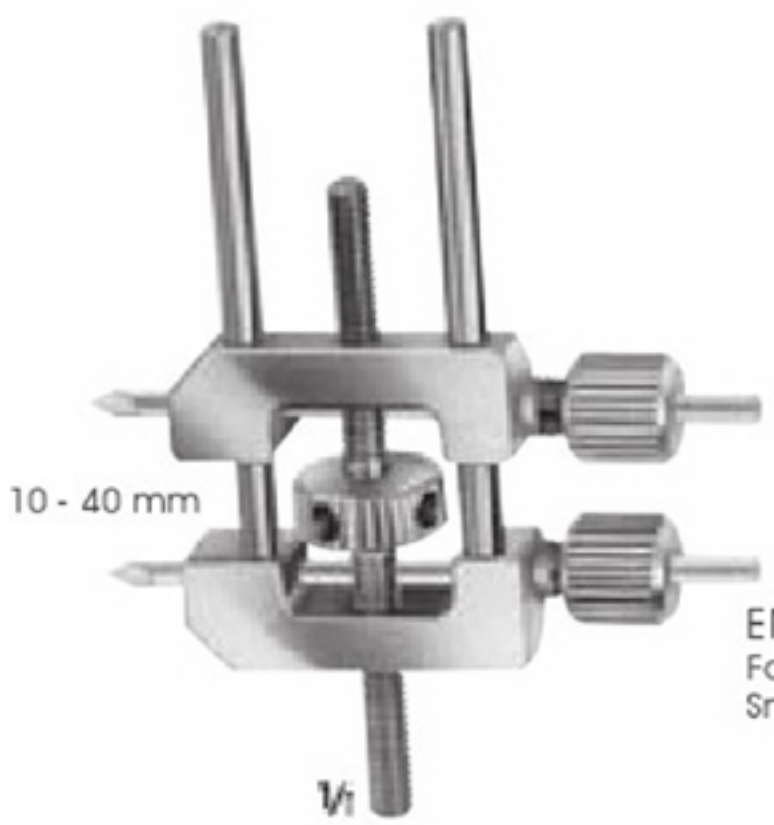

EM-18-2789
 For wires \varnothing 3.0 mm
 Small bones of the zoom apparatus



Position, Re-giver bony part of the wire
 can be screwed KIRSCHNER
 stabilization using

WÖRRLEIN
 EM-18-2790
 Repositöner
 16.5 cm

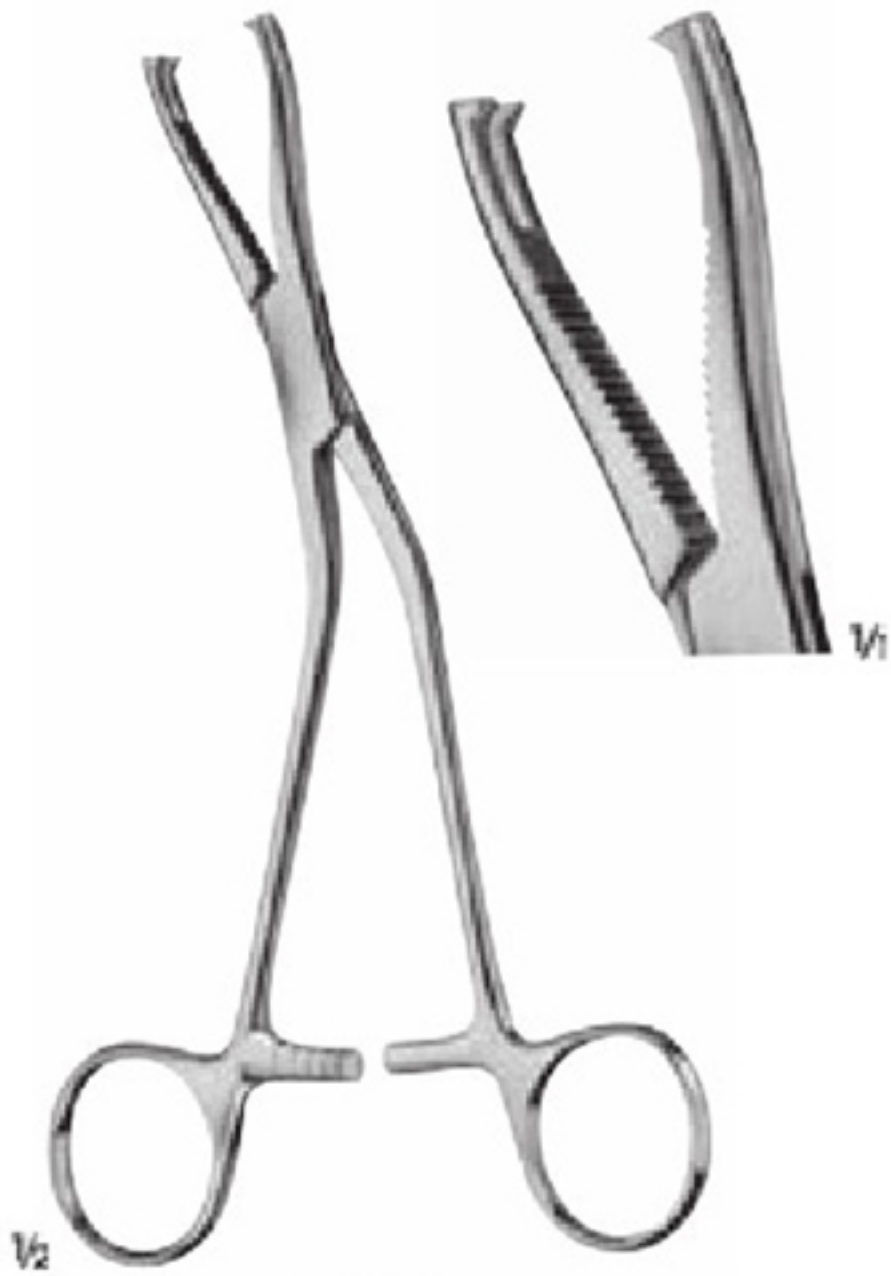

DINGMANN
EM-18-2791
18.5 cm



DINGMANN
EM-18-2792
18.5 cm



SEMB
EM-18-2793
19 cm



SEMB
EM-18-2794
19 cm



1/2
 EM-18-2795
 Forceps with ratchet fixation
 14 cm



1/2
 EM-18-2796-01
 Forceps with thread fixation
 17 cm



1/2
 EM-18-2796-02
 Forceps with thread fixation
 23.5 cm



5 mm
 M Vi

1/2
 EM-18-2797
 Bone holding forceps
 20 cm



11 mm
 M Vi

1/2
 LANGENBECK
 EM-18-2798
 Bone holding forceps
 20.5 cm



12 mm
 M Vi

1/2
 FERGUSSON
 EM-18-2799
 Bone holding forceps
 20.5 cm

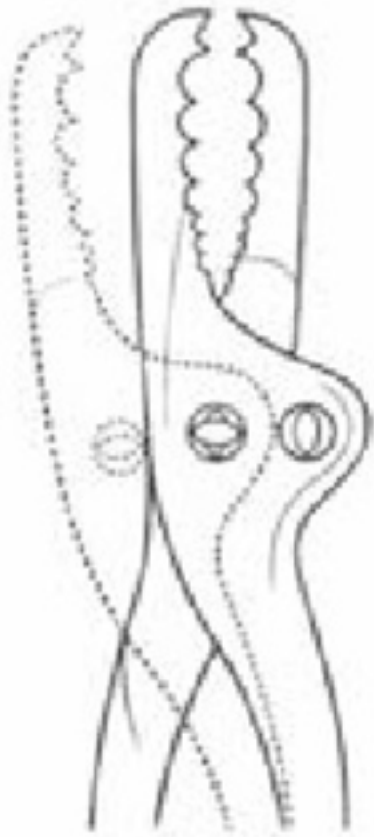

Ayarlanabilir ağız
Jaw adjustable



FARABEUF
EM-18-2800-01
23cm



FARABEUF
EM-18-2800-02
25.5 cm



FARABEUF-LAMBOTTE
EM-18-2801
25.5 cm





KERN-MINI
EM-18-2803-01
15.5 cm



KERN-LANE
EM-18-2803-02
24 cm



LANE
EM-18-2803-03
32 cm

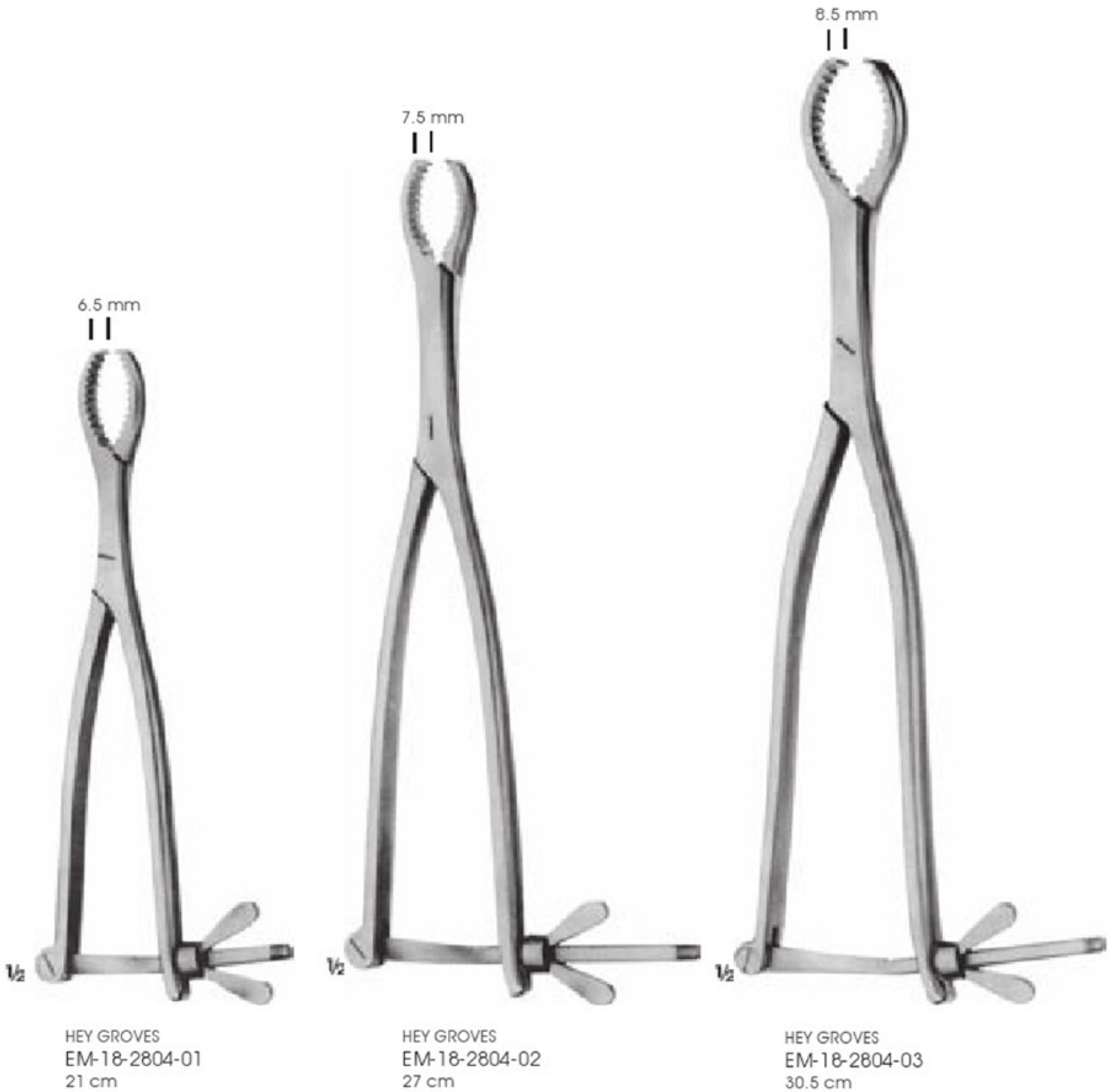

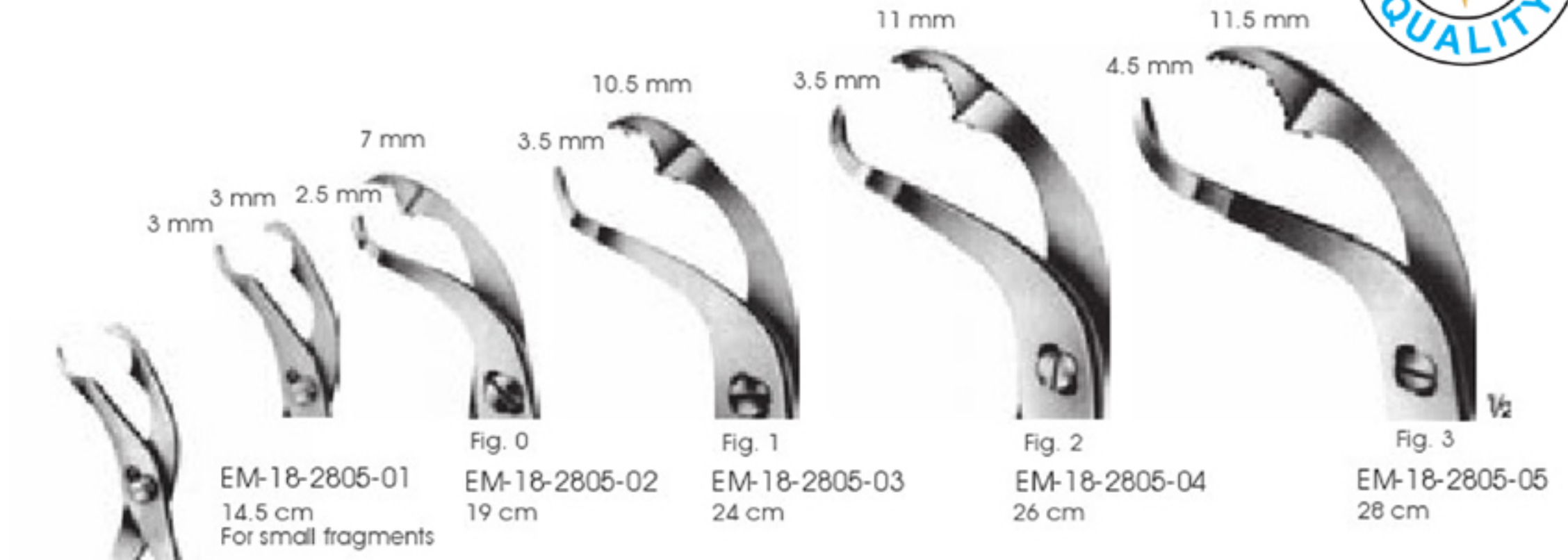

EM-18-2805-01 - 2805-05
Self-centering forceps with
thread fixation

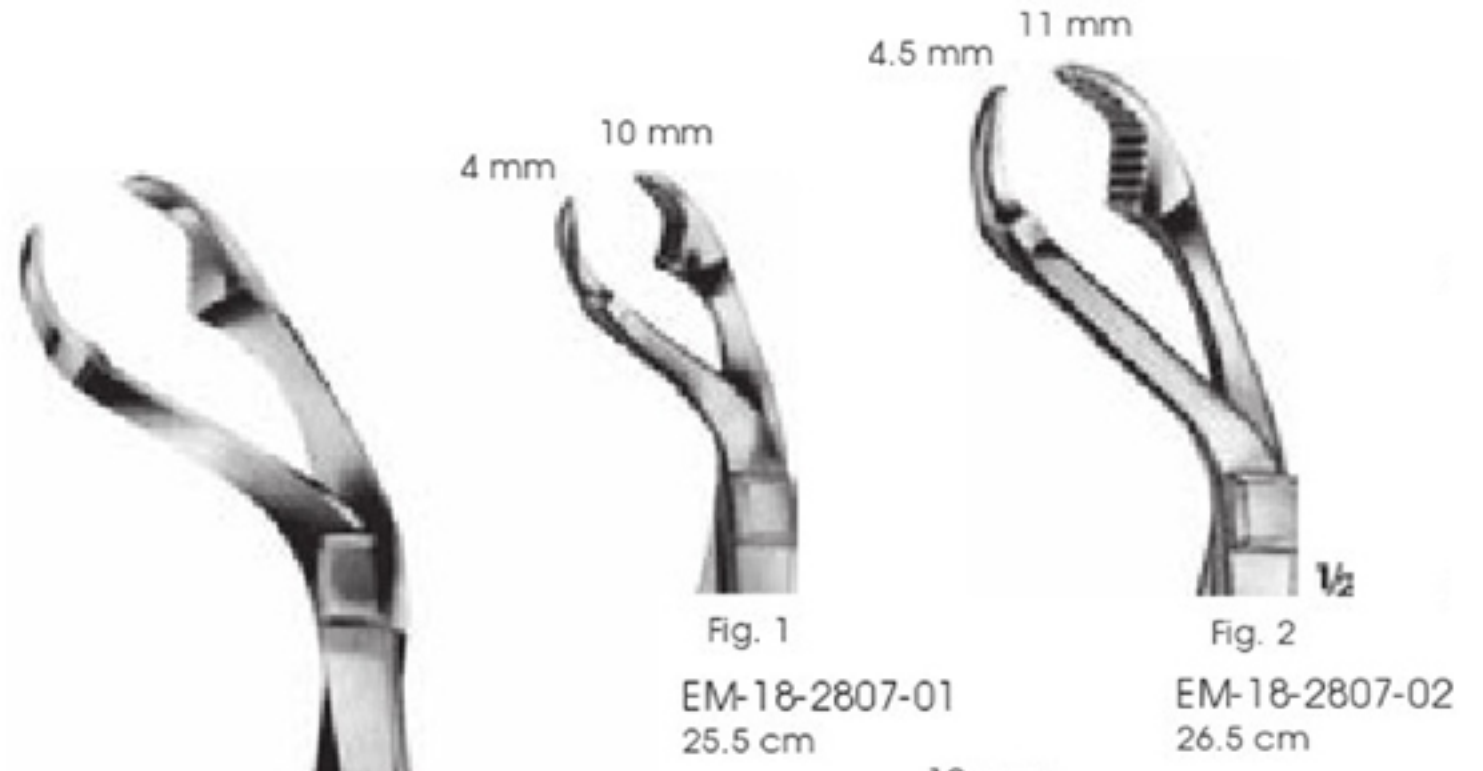

VERBRUGGE
EM-18-2806
17.5 cm

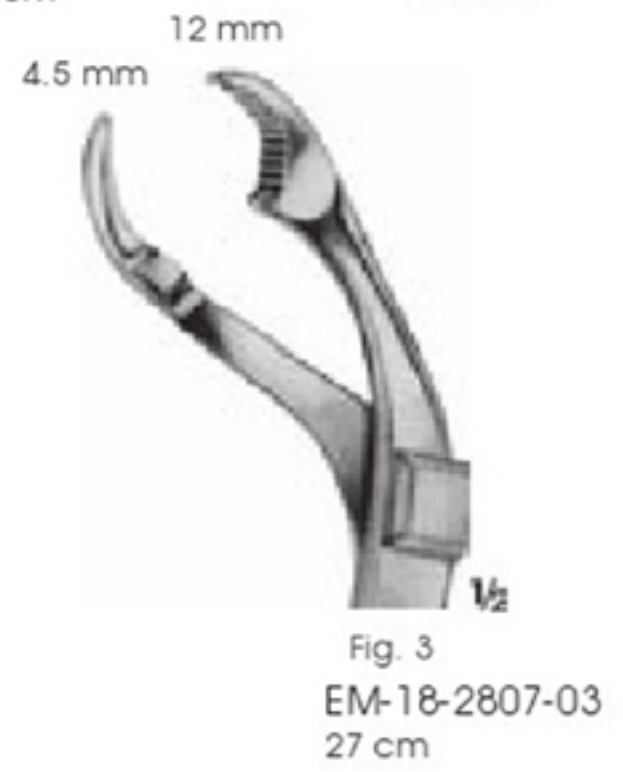



EM-18-2808-01
22 cm



EM-18-2808-02
26 cm



EM-18-2808-03
33 cm

LAMBOTTE
EM-18-2808-01 - 2808-03



EM-18-2809
21.5 cm

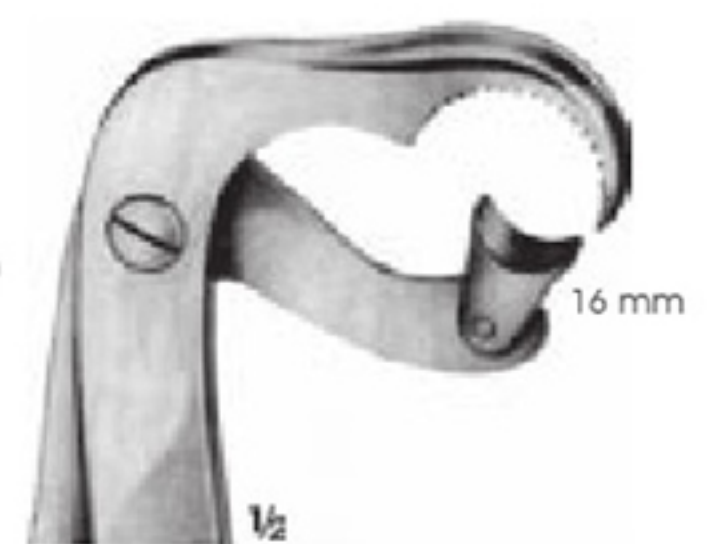

EM-18-2810
27.5 cm

EM-18-2809 - 2810



LOWMAN
EM-18-2811-01 17 cm
EM-18-2811-02 20.5 cm



$\frac{1}{2}$
LOWMAN-GERSTER
EM-18-2811-03
21 cm



$\frac{1}{2}$
LOWMAN-HOGLUND
EM-18-2812
17.5 cm

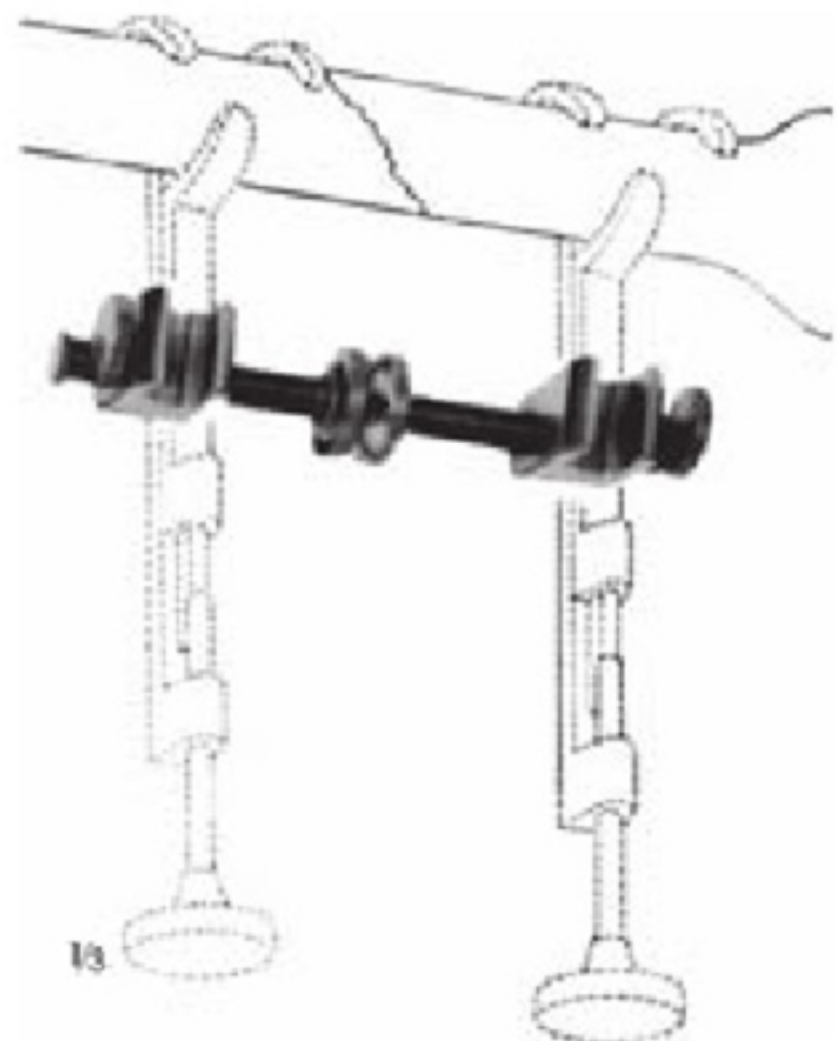

$\frac{1}{3}$
GERSTER
EM-18-2813
Traction bar for EM-18-2811-01 - 2813

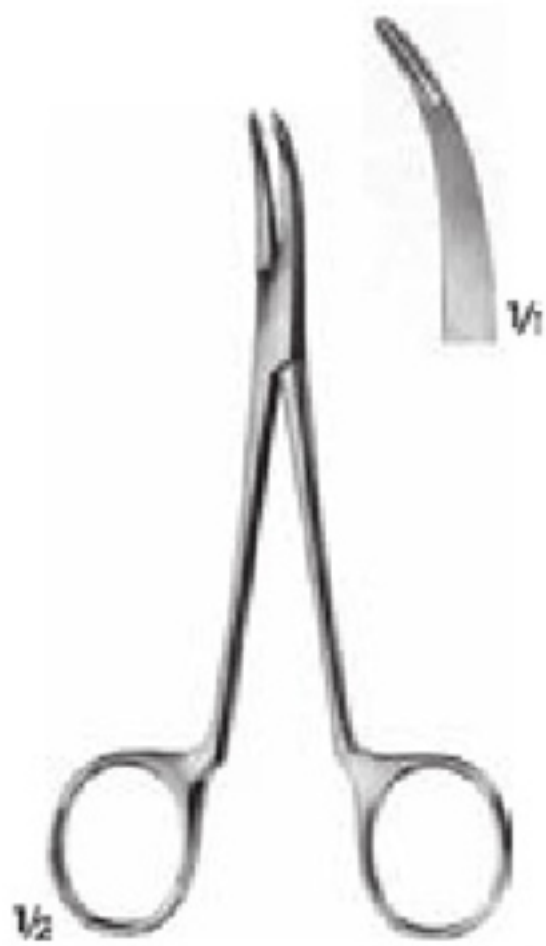

EM-18-2814
 Synovectomy rongeur
 Width of jaws 2.0 mm
 13 cm



STELLBRINK
 EM-18-2815
 Synovectomy rongeur
 17.5 cm



STELLBRINK
 EM-18-2816
 Synovectomy rongeur
 17 cm

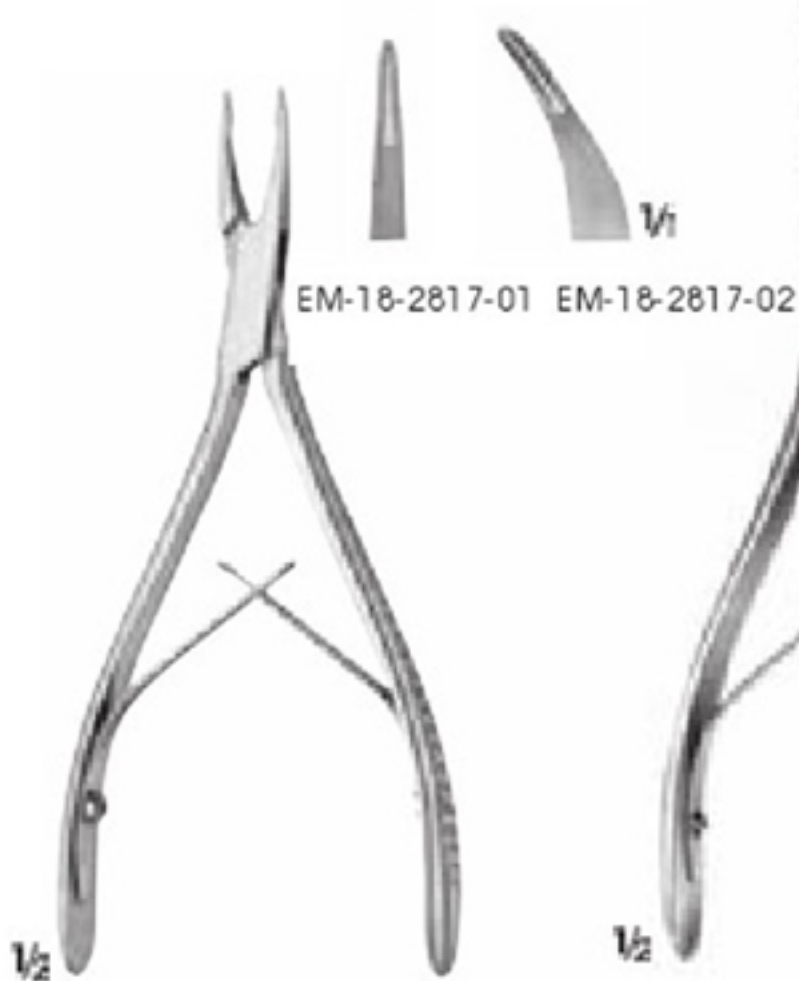

FRIEDMANN
 EM-18-2817-01 - 2817-02
 Bone Ronjur
 14 cm



EM-18-2818
 Bone Ronjur
 15 cm

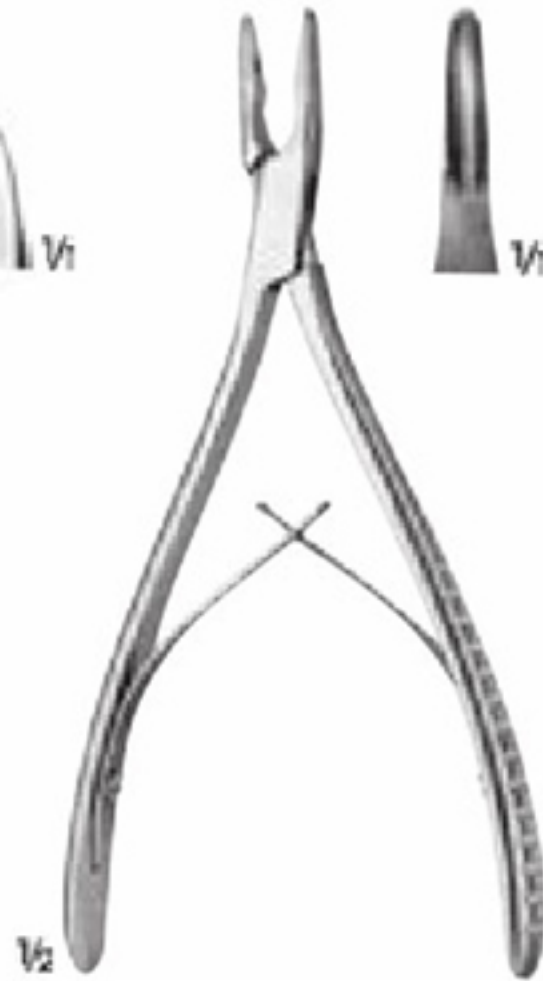

LEMBERT
 EM-18-2819
 Bone Ronjur
 16.5 cm



SCHWARZ
 EM-18-2820
 Bone Ronjur
 14.5 cm



LUER-FRIEDMANN
EM-18-2821
Bone Rongeur
14.5 cm



EM-18-2822
14 cm



LUER
EM-18-2823
15 cm



LUER
EM-18-2824
15.5 cm



BLUMENTHAL
EM-18-2825
15.5 cm

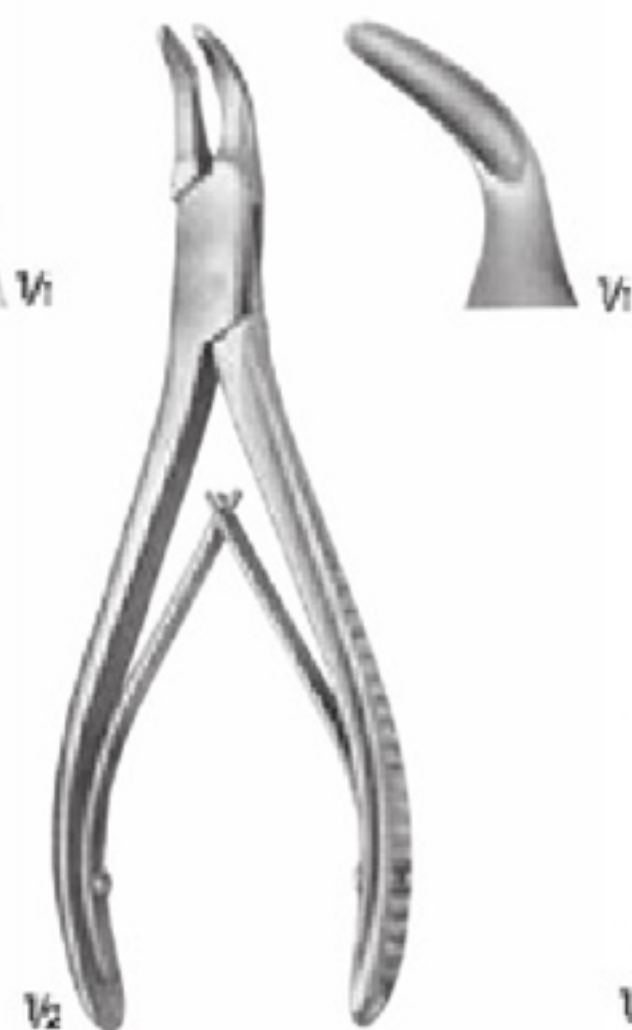

BLUMENTHAL
EM-18-2826
15 cm

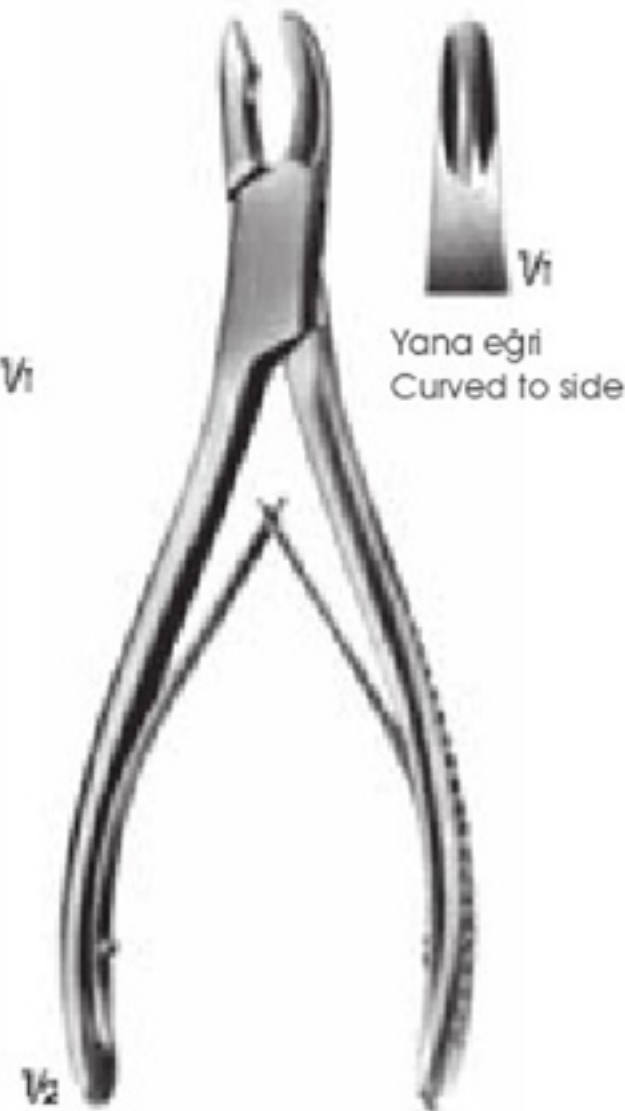

HAKANSSON
EM-18-2827
17 cm

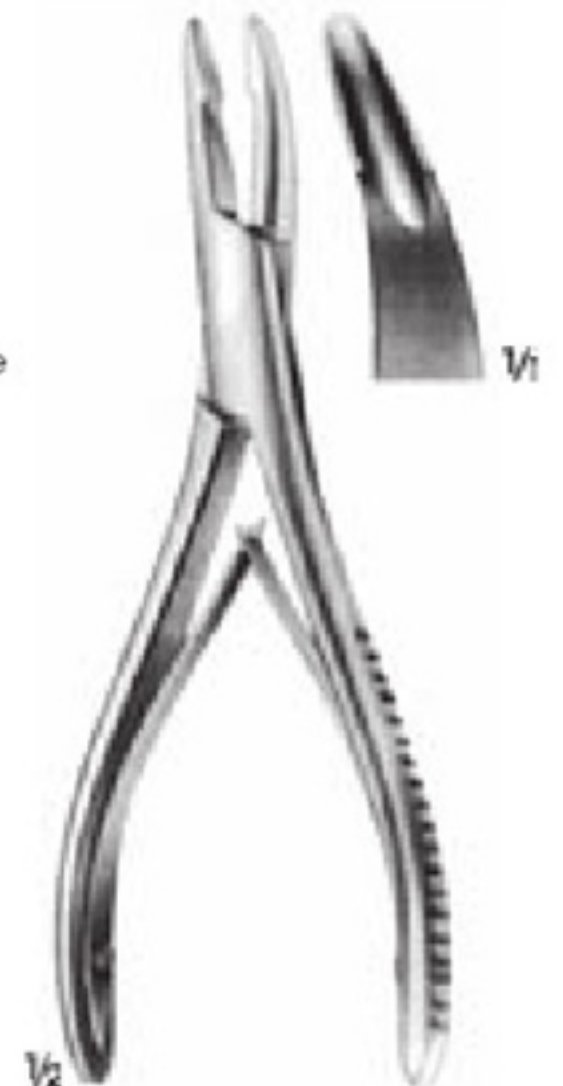

MEAD
EM-18-2828
16.5 cm



JANSEN
EM-18-2829
17.5 cm



JANSEN
EM-18-2830
17.5 cm

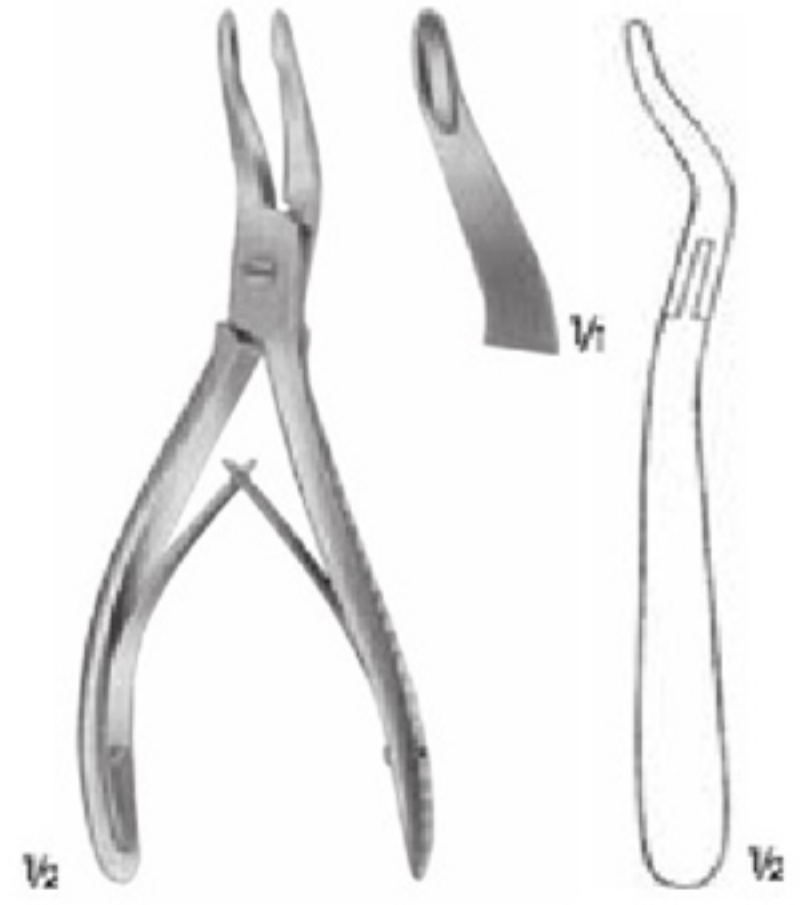

ALEXANDER
EM-18-2831
14 cm

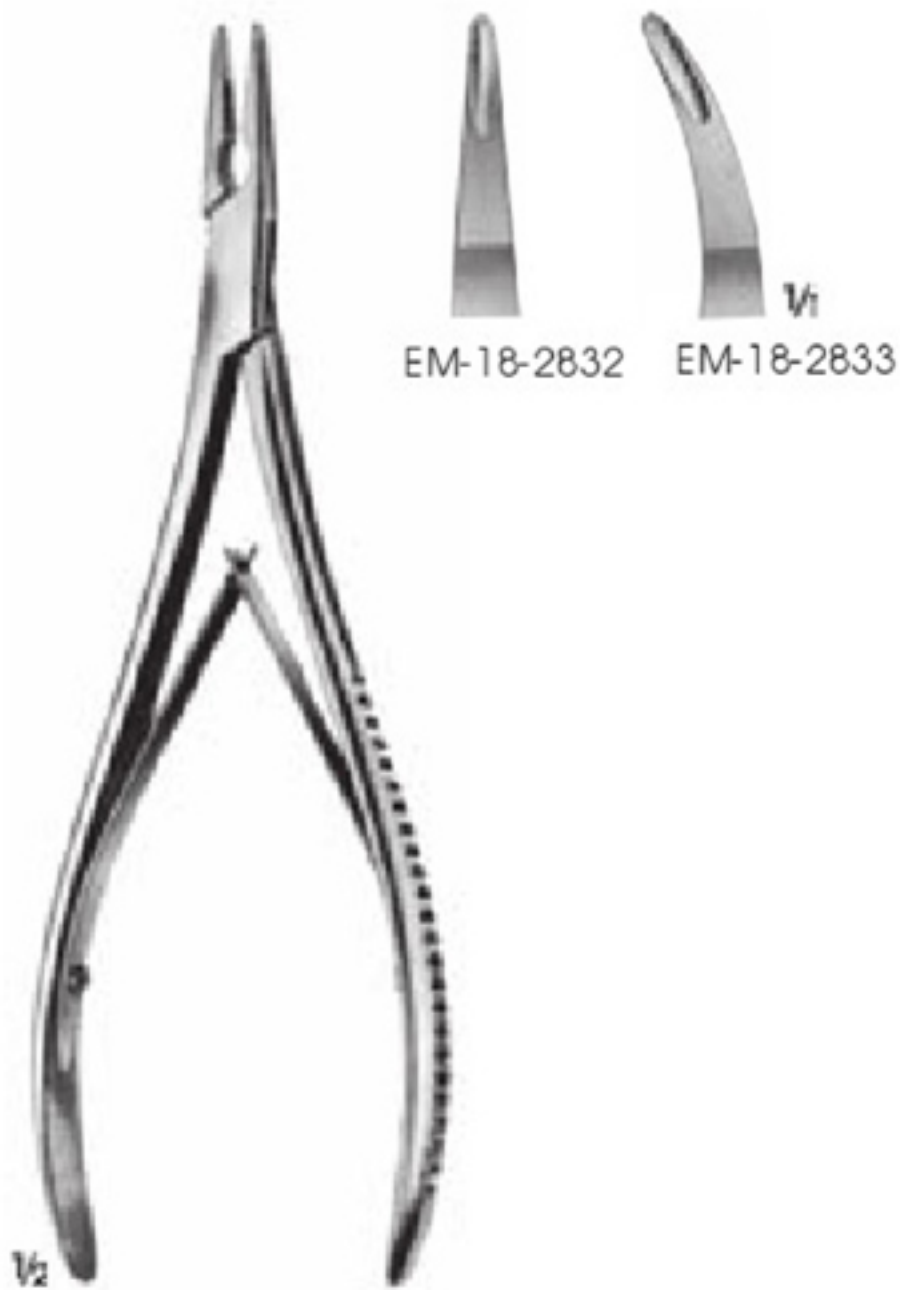

LEMPERT
EM-18-2832 - 18-2833
20 cm



JANSEN
EM-18-2834
19 cm



BEYER
EM-18-2835
18 cm



LUER
EM-18-2836 - 2837
17.5 cm

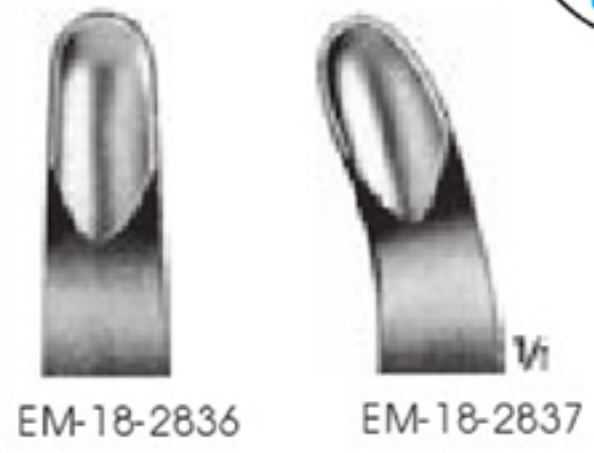

EM-18-2836

EM-18-2837

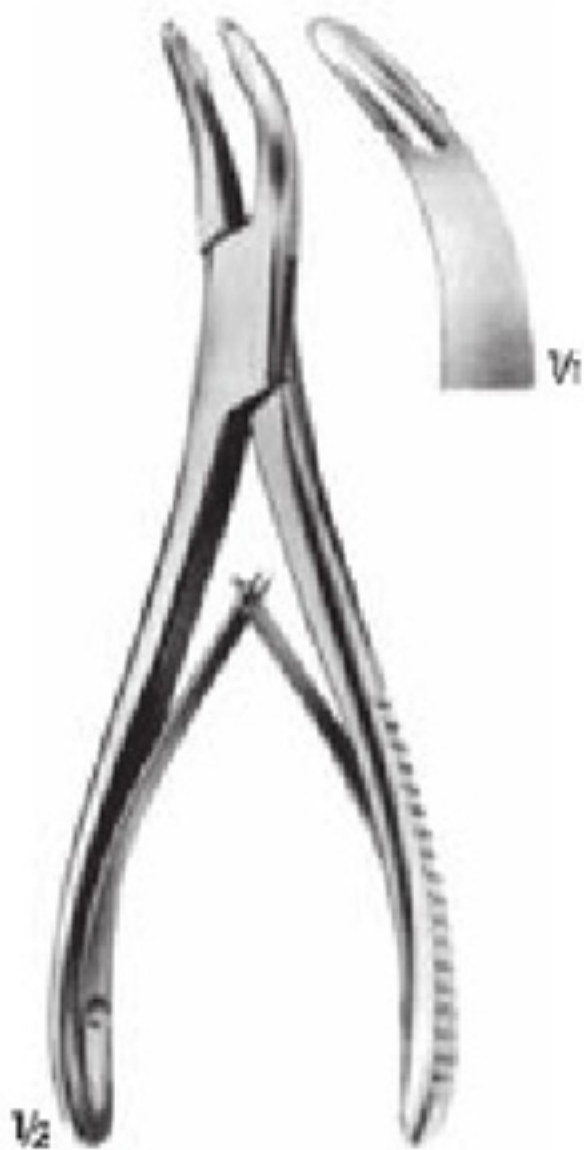

BANE-HARTMANN
EM-18-2838
17.5 cm



LUER
EM-18-2839
18 cm



LUER
EM-18-2840
18 cm

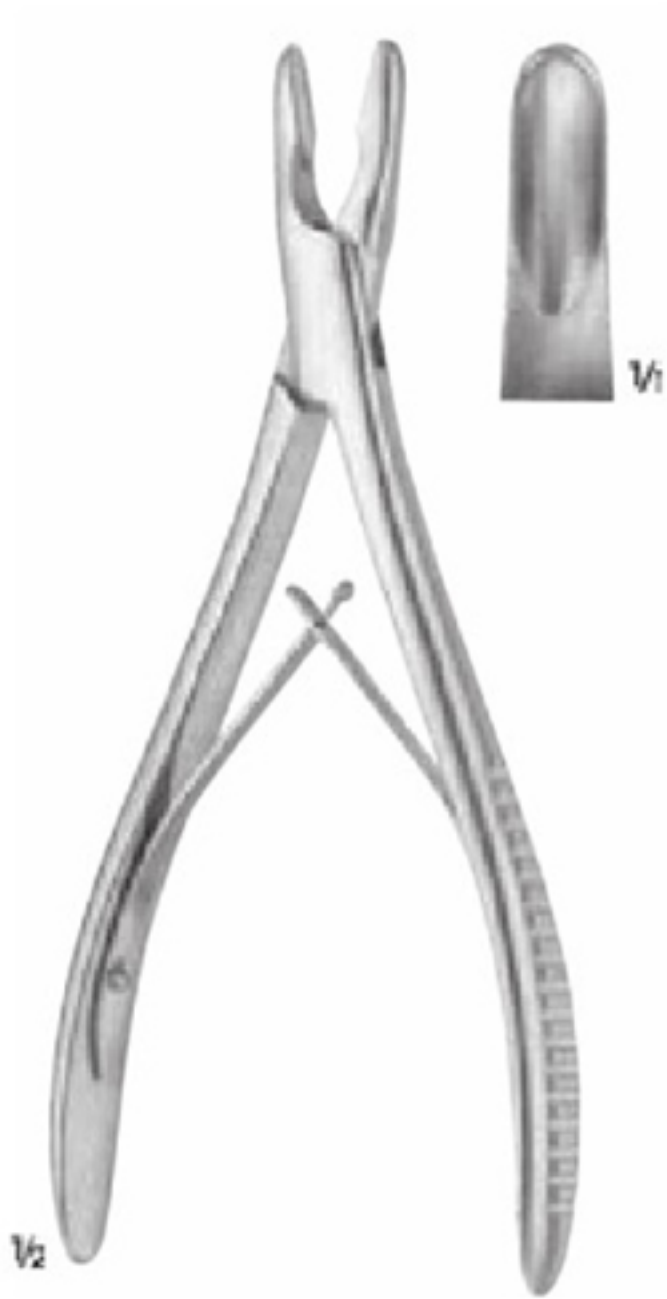

ADSON
EM-18-2841
20 cm



NORTHFIELD
EM-18-2842
21 cm



PENNYBACKER
EM-18-2843
20.5 cm



TROTTER
EM-18-2844
20.5 cm



GULEKE
EM-18-2845
20.5 cm

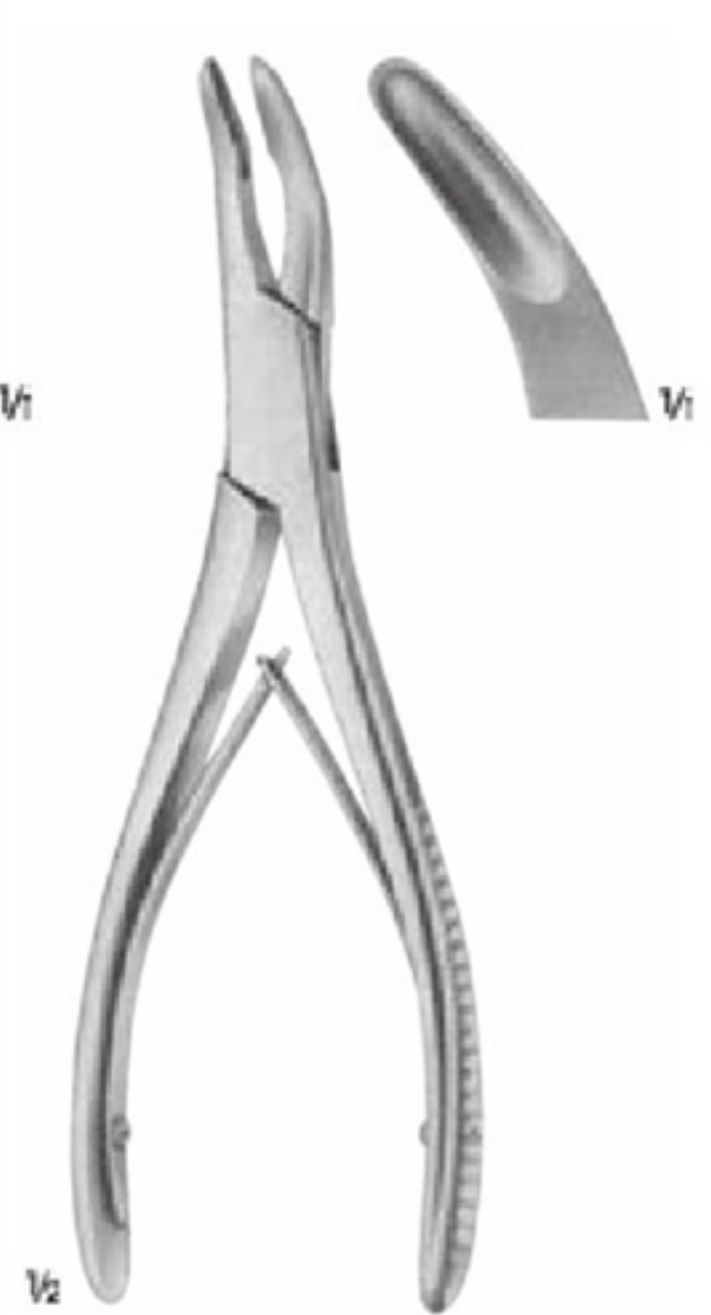

OLIVECRONA
EM-18-2846
20.5 cm

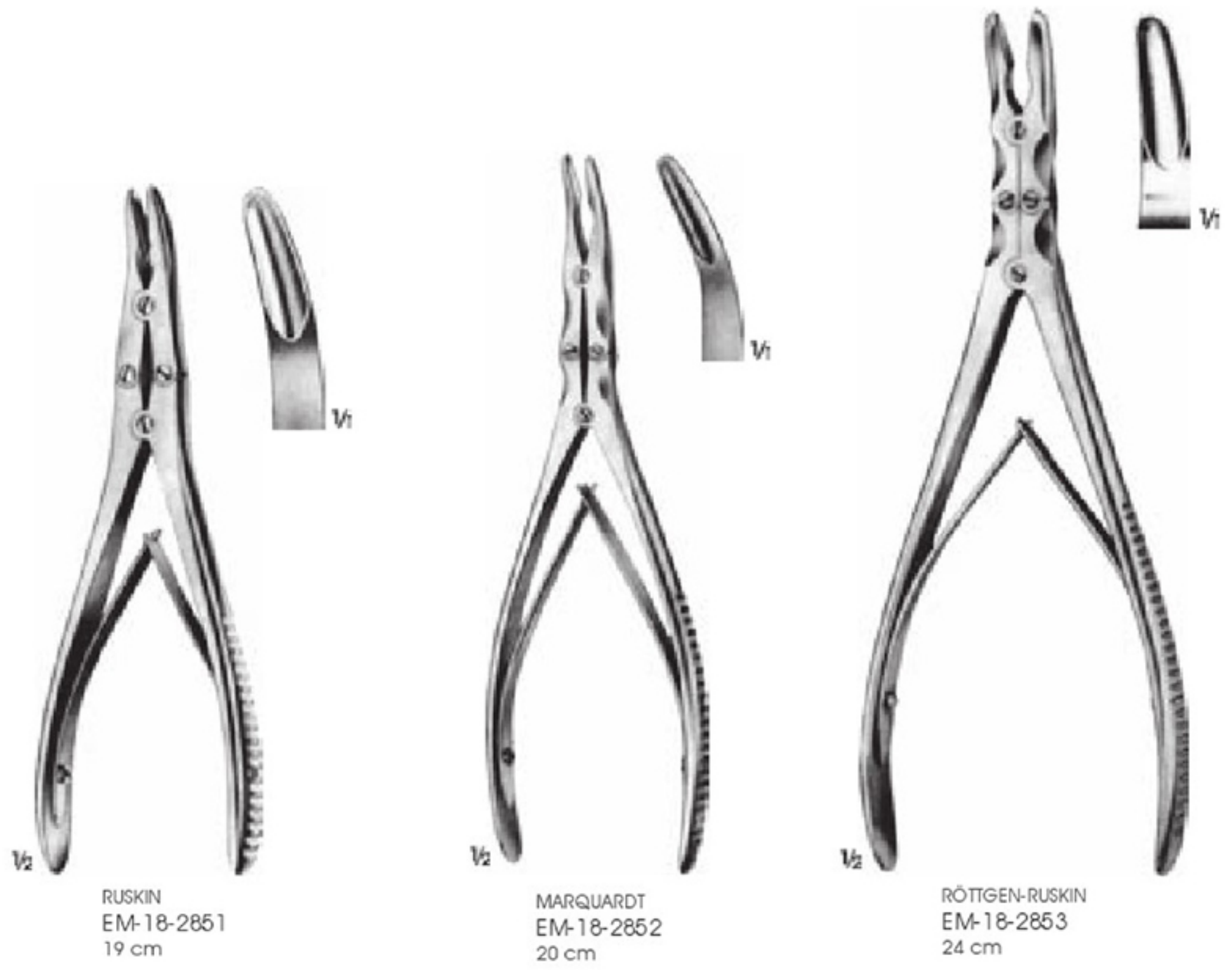
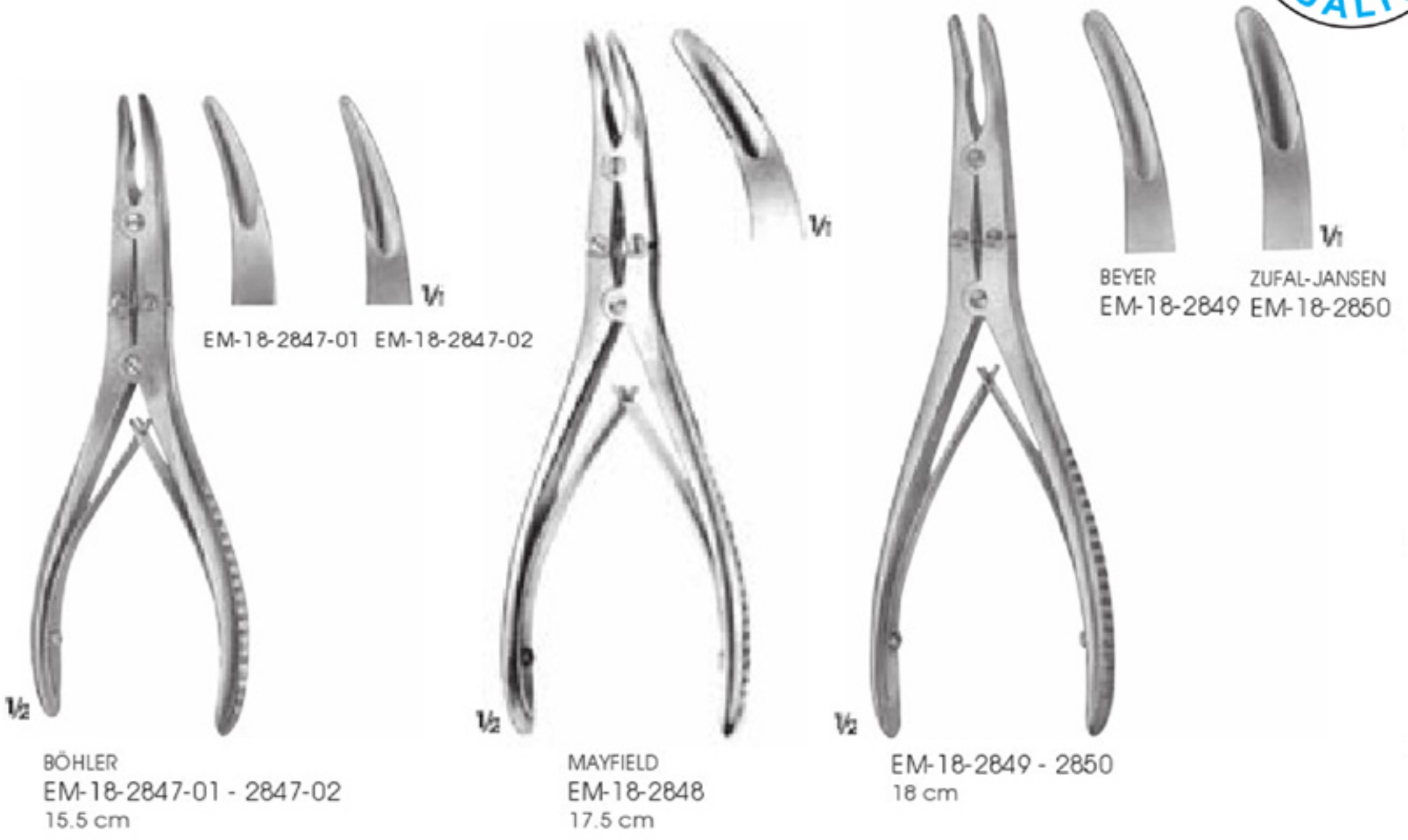

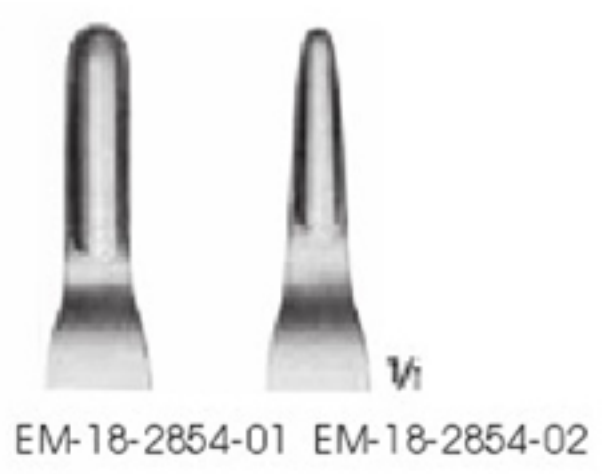

EM-18-2854-01 EM-18-2854-02

LEKSELL
EM-18-2854-01 - 2854-02
24.5 cm



FRYKHOLM
EM-18-2855
24 cm

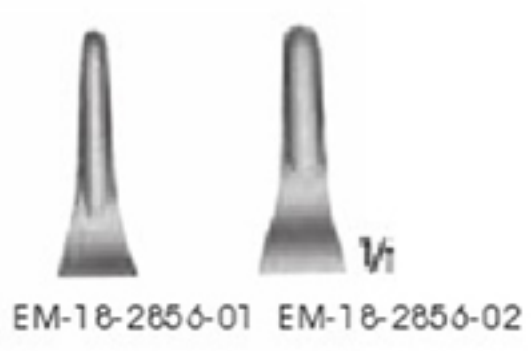

EM-18-2856-01 EM-18-2856-02

ECHLIN
EM-18-2856-01 - 2856-02
23 cm



STILLE
EM-18-2857
23.5 cm



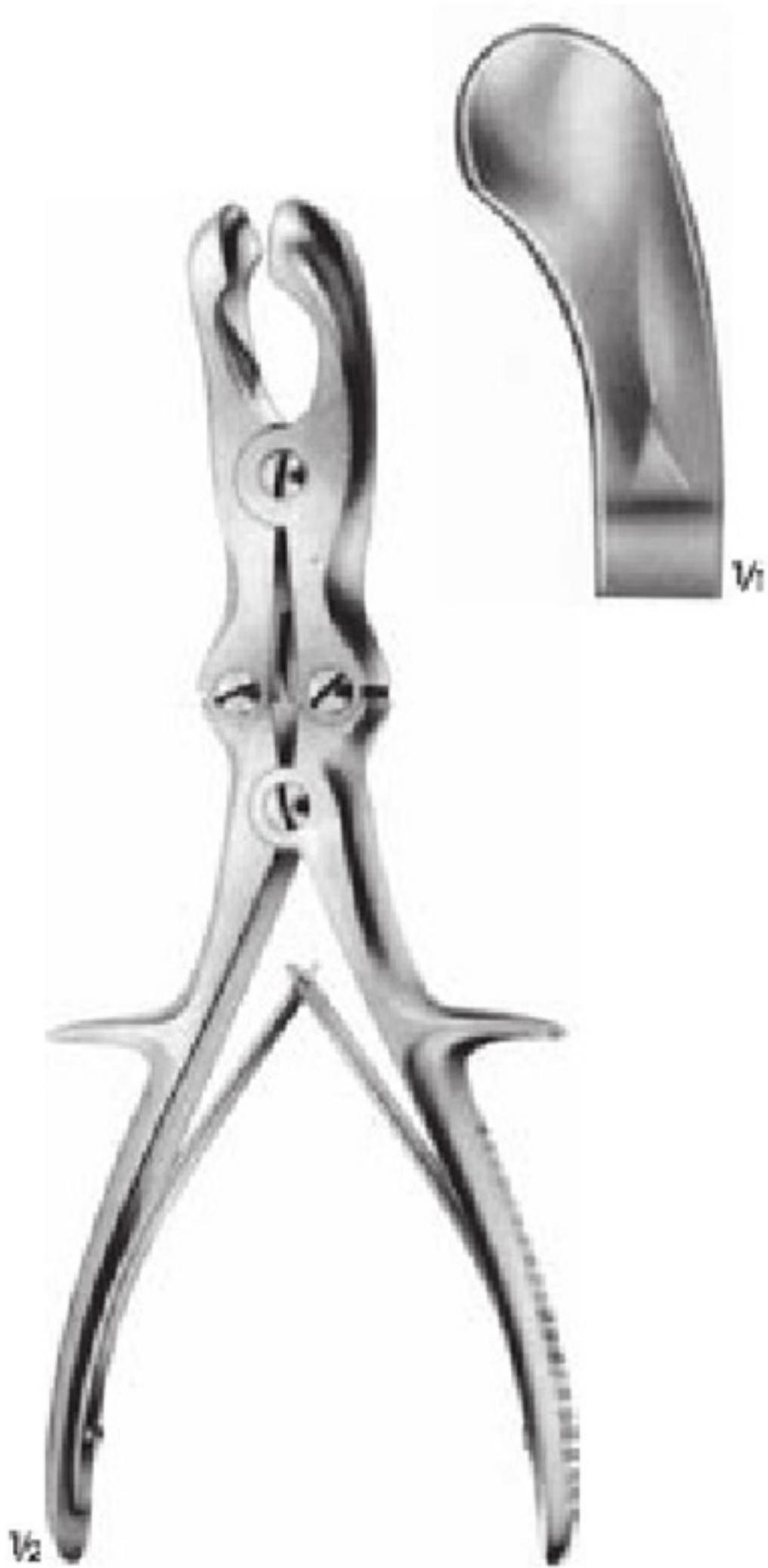

SEMBO
EM-18-2863
24 cm



LUER-STILLE
EM-18-2863
27 cm

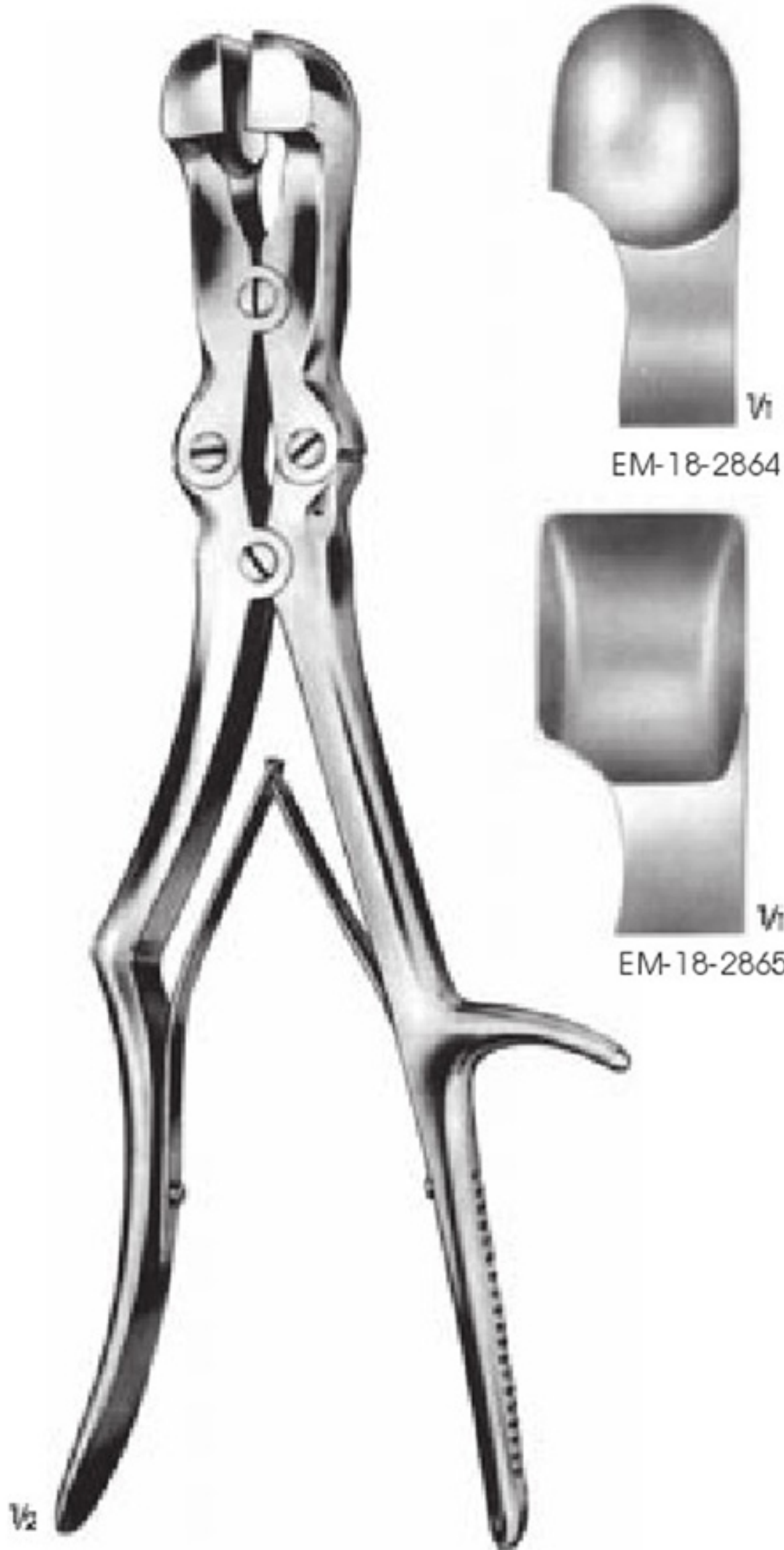

SAUERBRUCH-CORYLLOS
EM-18-2864 - 2865
31 cm



SYPERT
EM-18-2866
36 cm

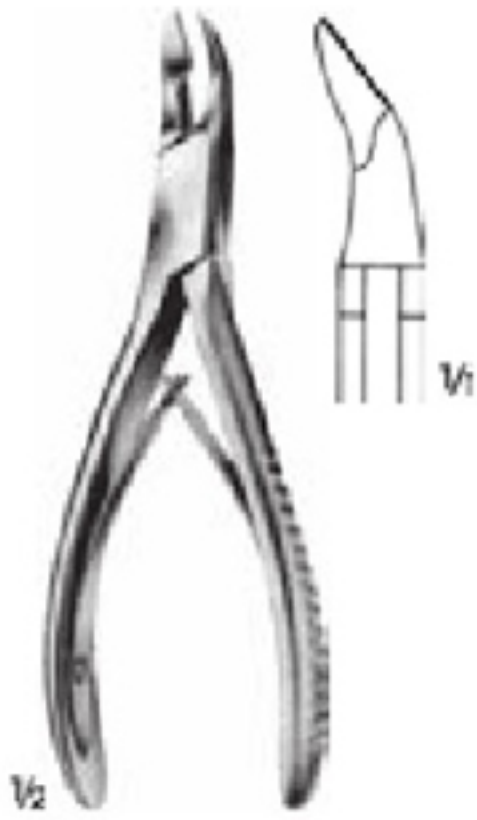

EM-18-2867
13 cm



STAMM
EM-18-2868
15 cm



EM-18-2869
17 cm

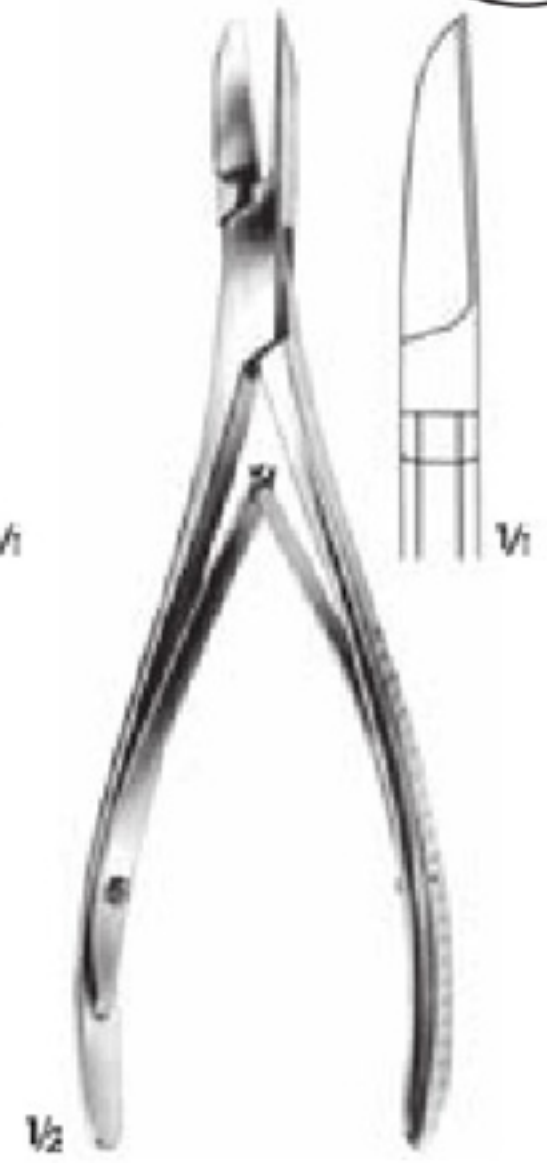

KAZANJIAN
EM-18-2870
18.5 cm

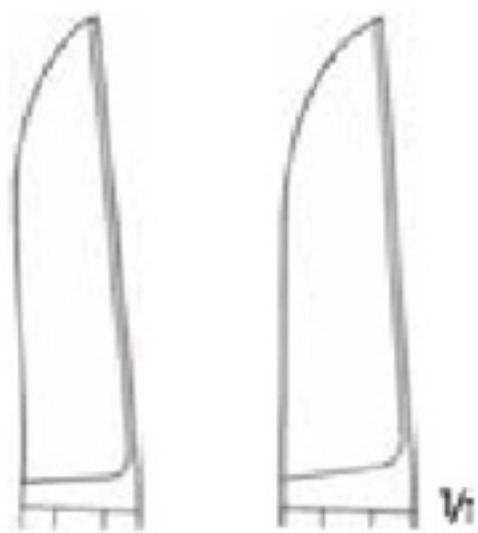

EM-18-2871-03 20 cm
EM-18-2871-04 22 cm

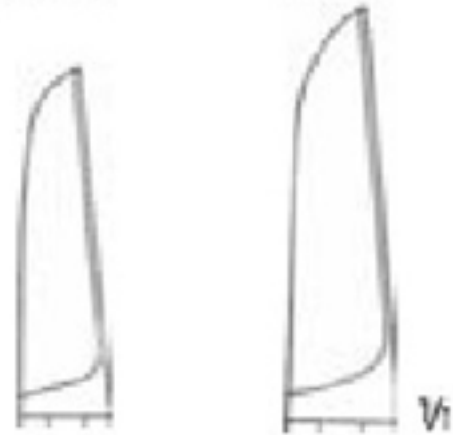

EM-18-2871-01 14 cm
EM-18-2871-02 17 cm



EM-18-2872-01
17 cm



EM-18-2872-02
20 cm



EM-18-2872-03
22 cm



LISTON
EM-18-2871-01 - 2871-04



LISTON
EM-18-2872-01 - 2872-03



BÖHLER
EM-18-2873
14.5 cm



BÖHLER
EM-18-2874
14.5 cm

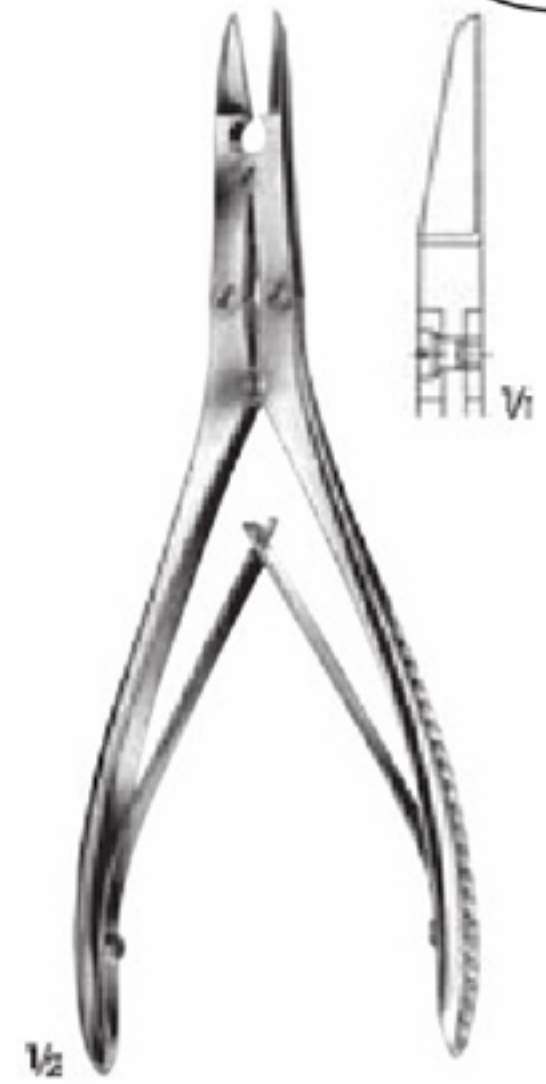

EM-18-2875
17 cm



MC INDOE
EM-18-2876
17.5 cm



RUSKIN-LISTON
EM-18-2877
19 cm

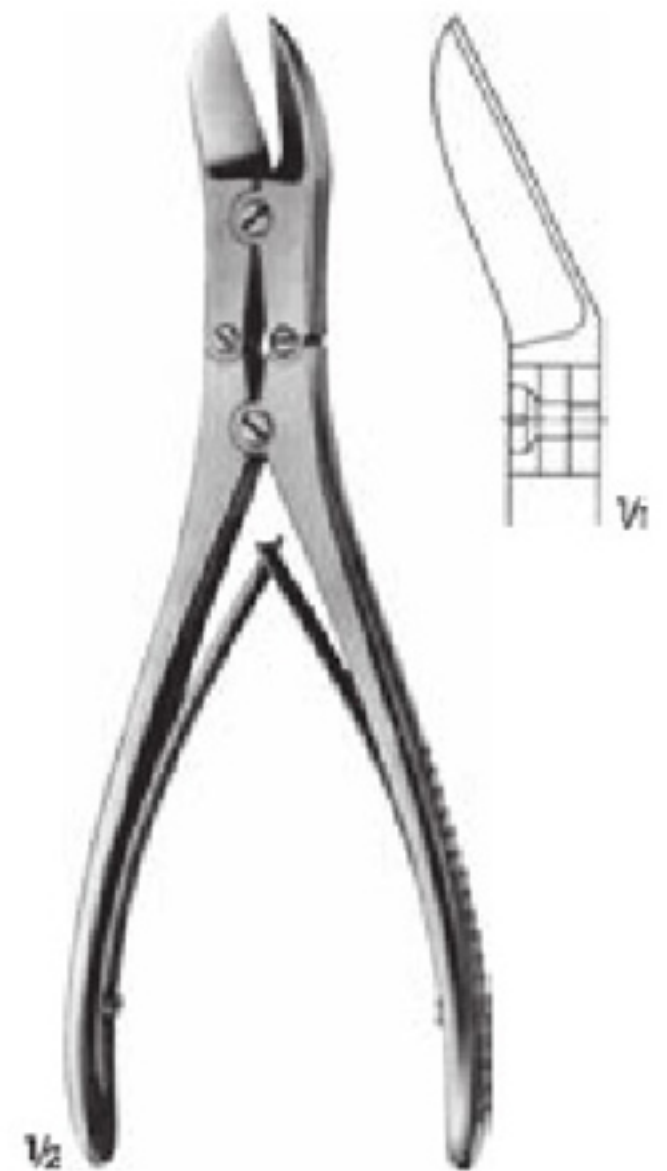

RUSKIN-LISTON
EM-18-2878
19 cm

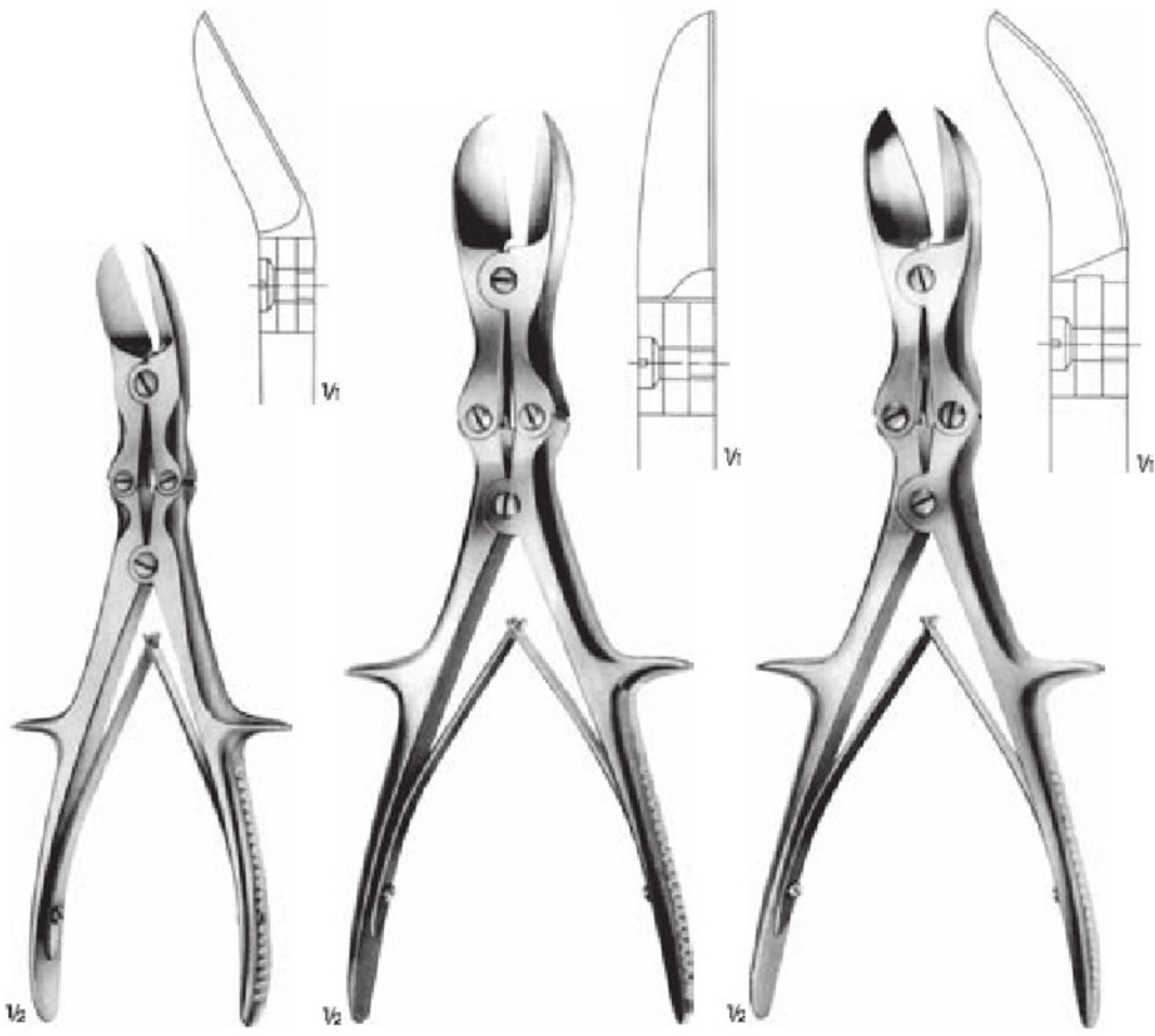

LISTON
EM-18-2879
Curved on flat
24 cm

LISTON
EM-18-2880
Straight
28 cm

LISTON
EM-18-2881
Curved on flat
28 cm

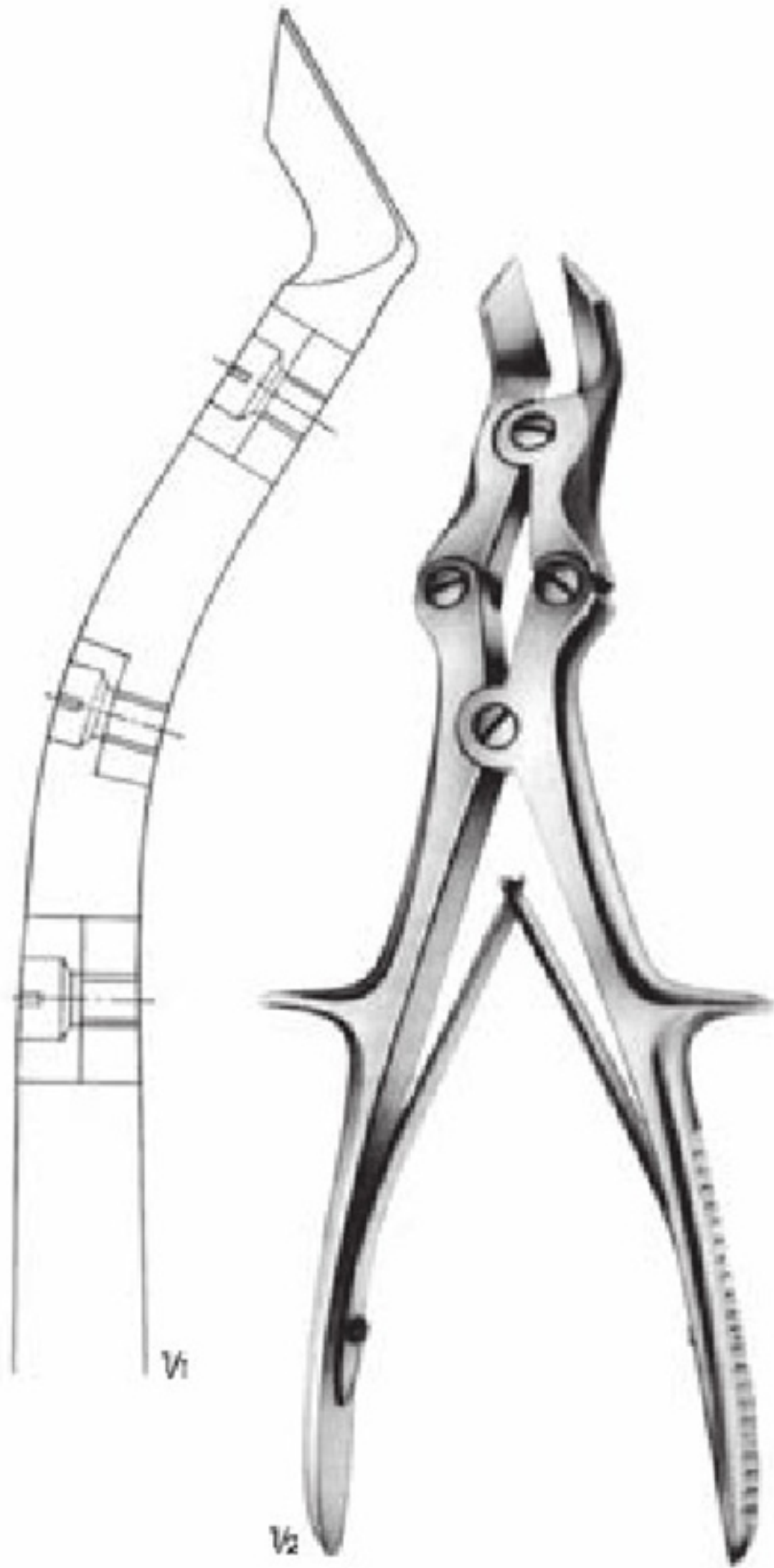

LISTON-KEY-HORSLEY
EM-18-2882
25.5 cm

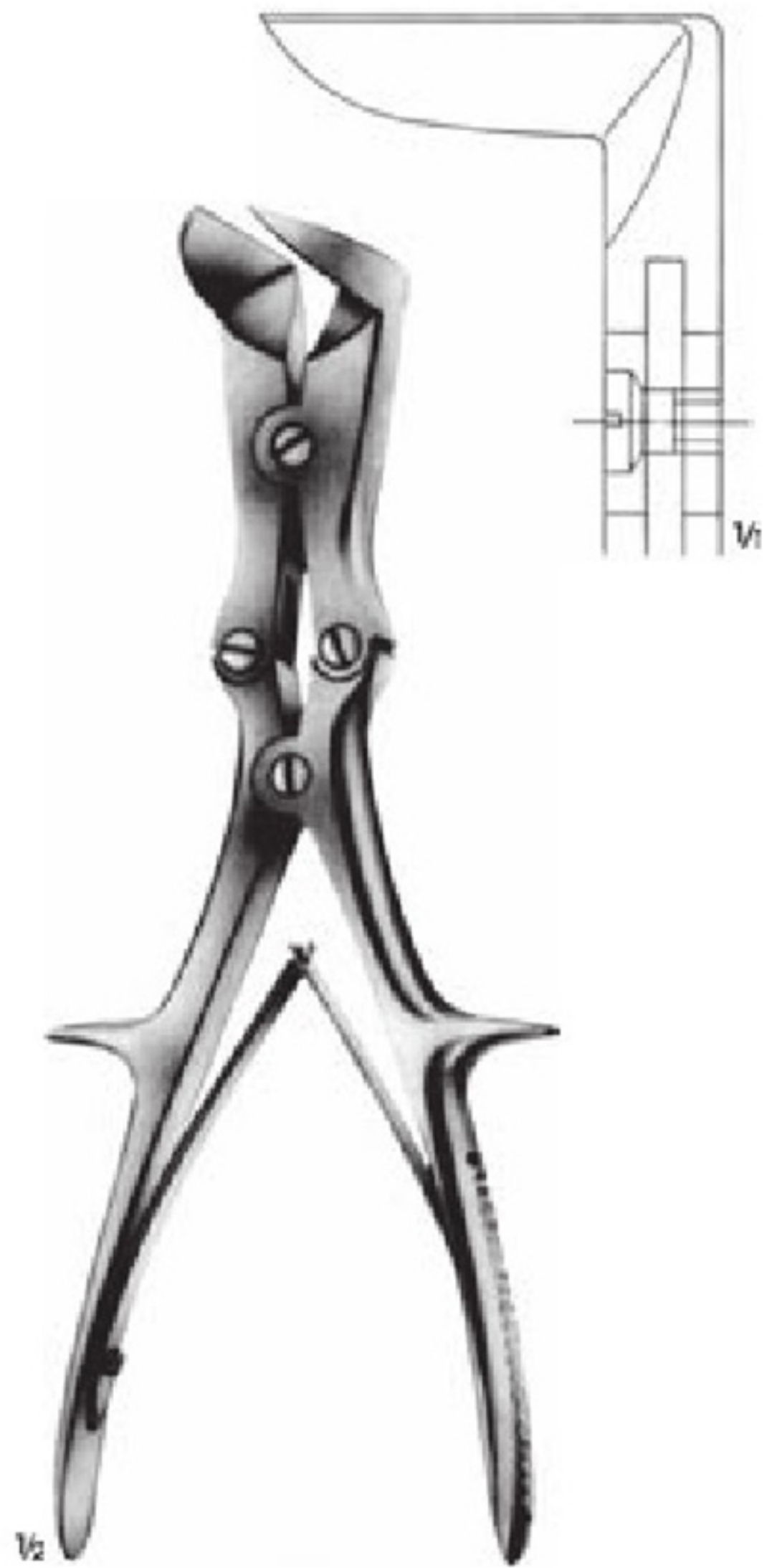

LISTON-STILLÉ
EM-18-2883
26.5 cm

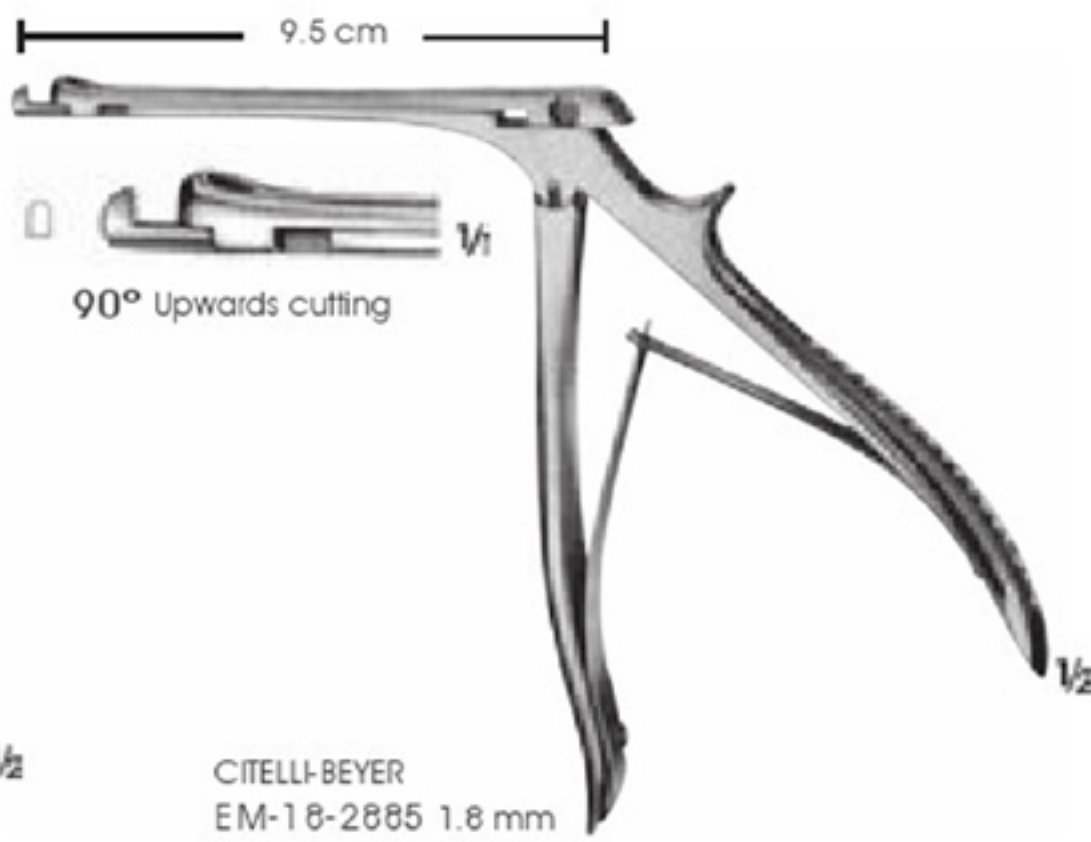
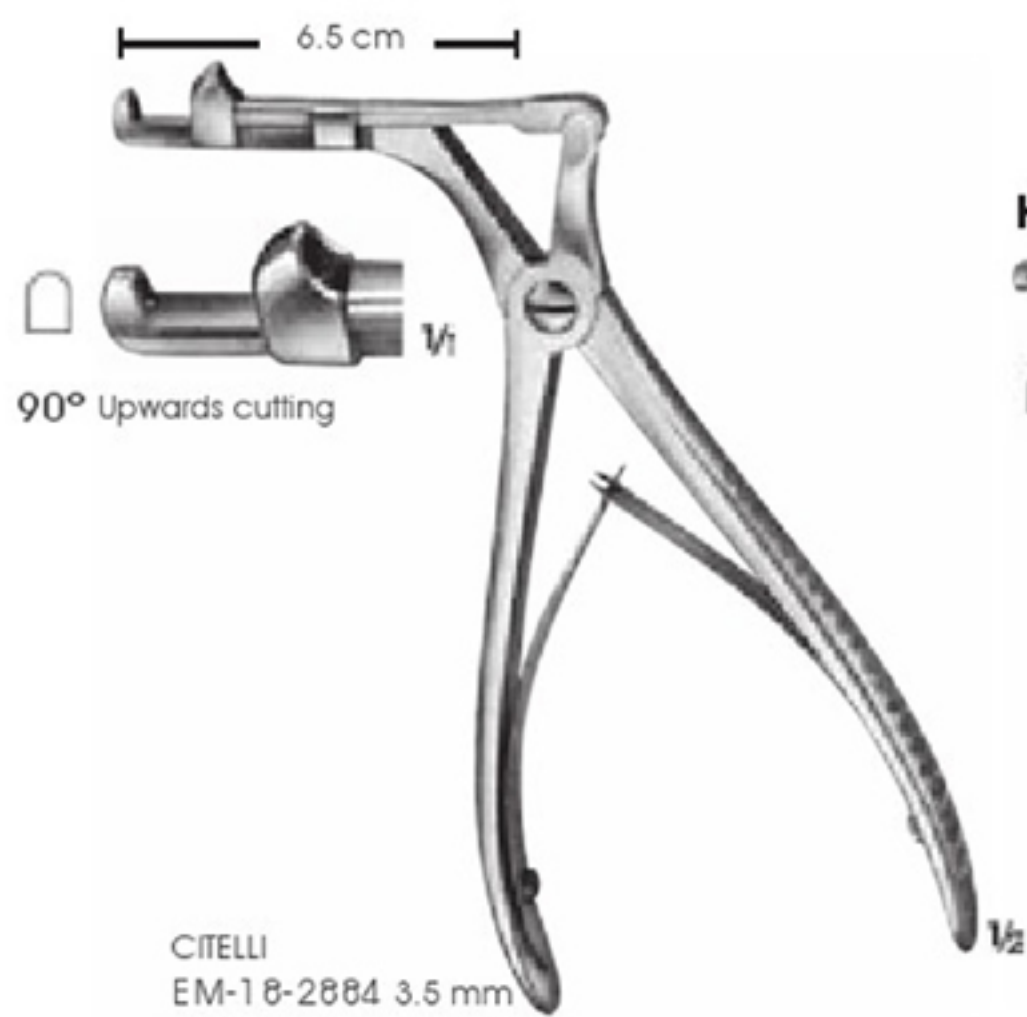
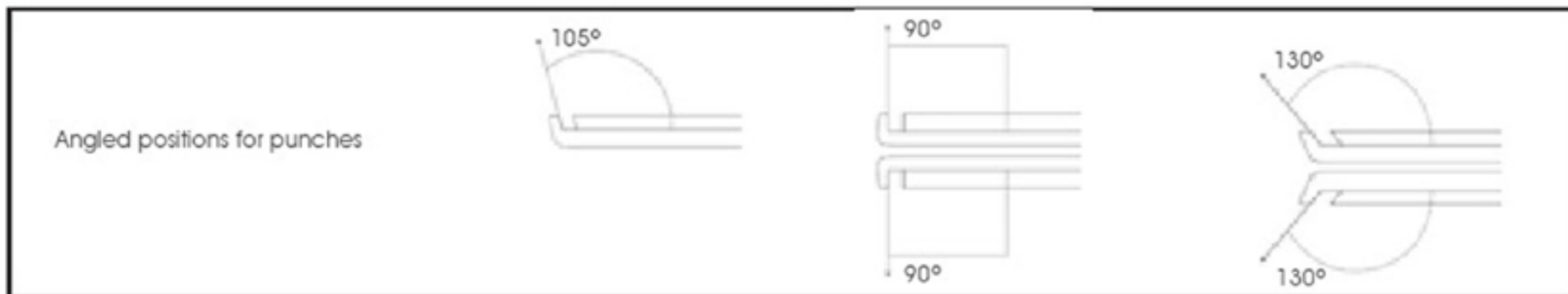

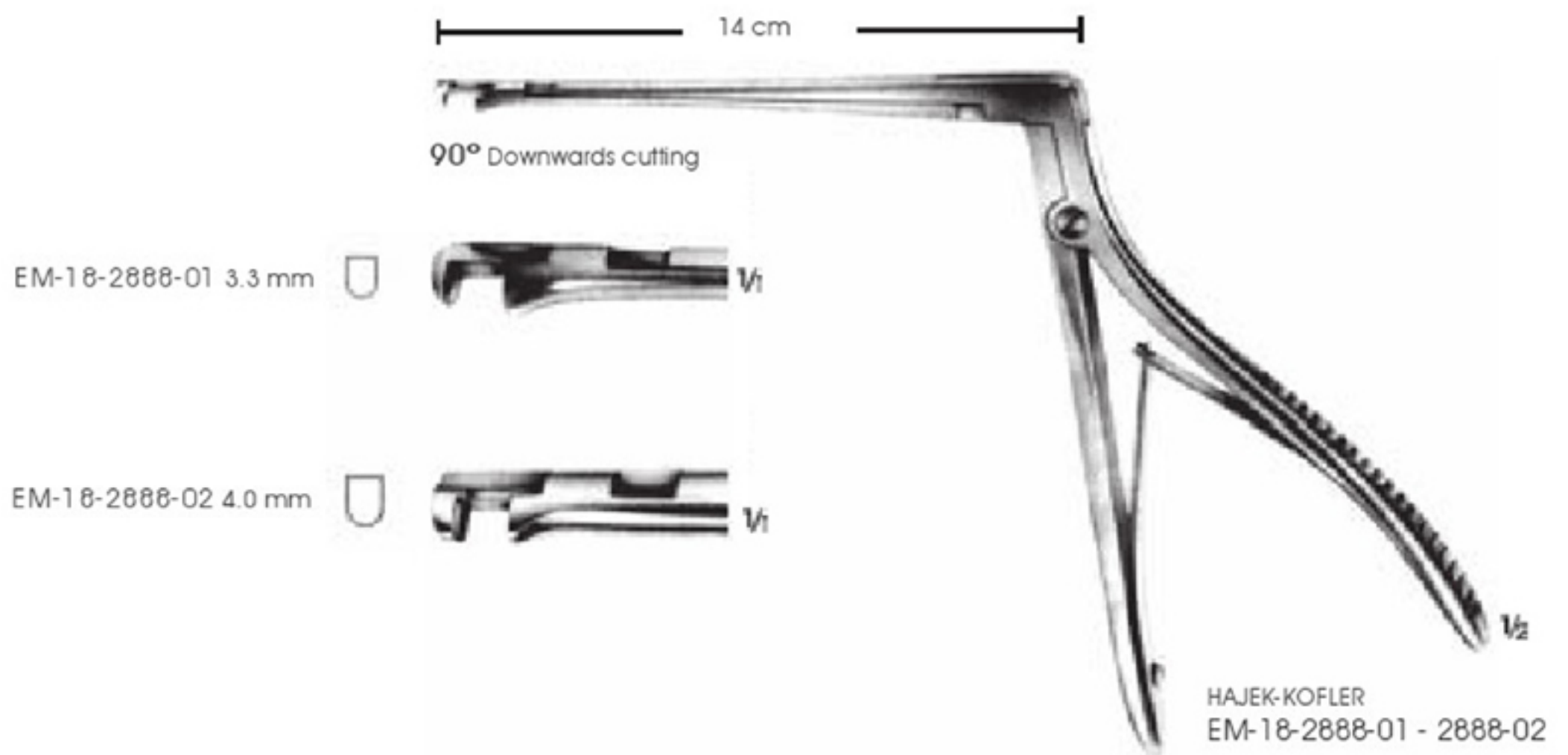

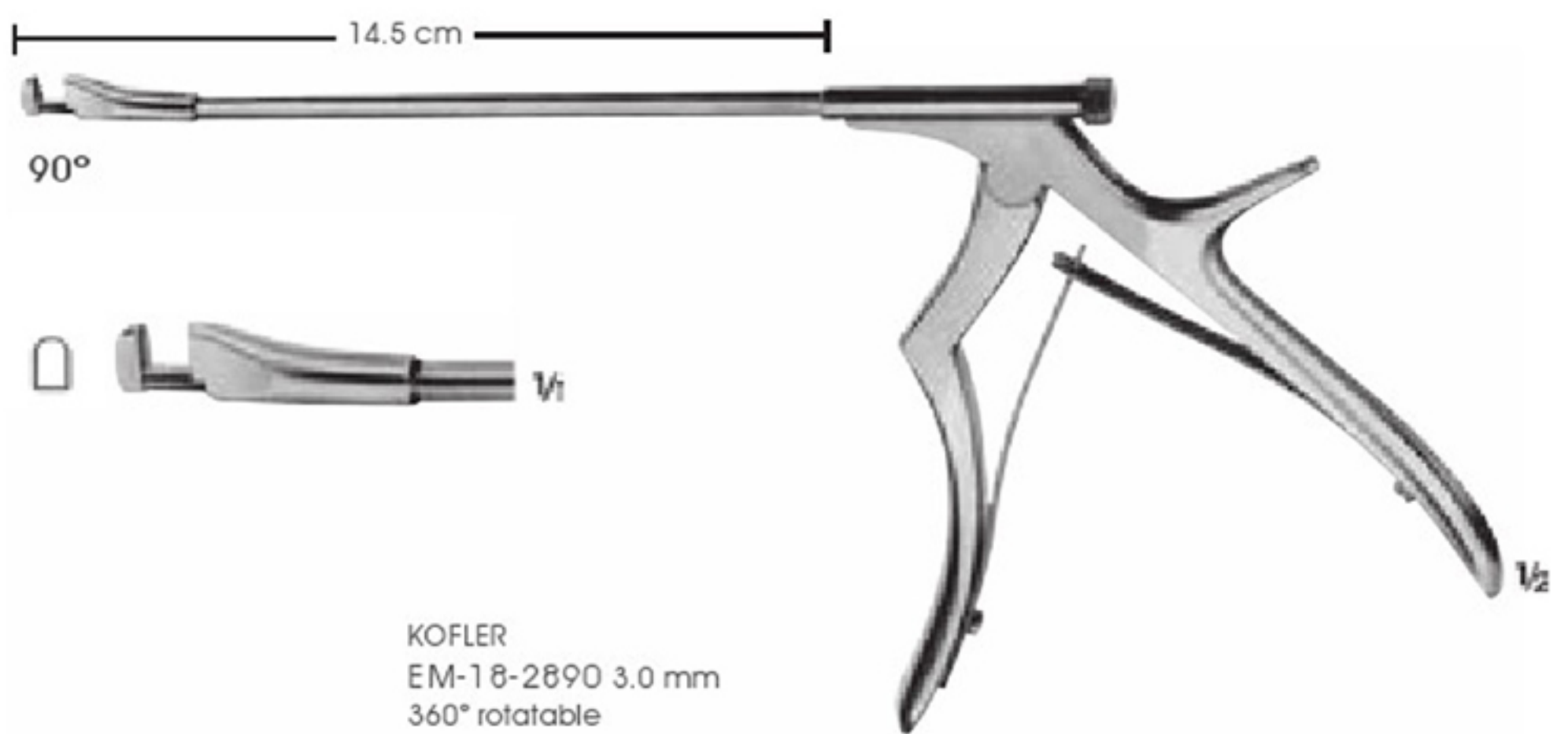
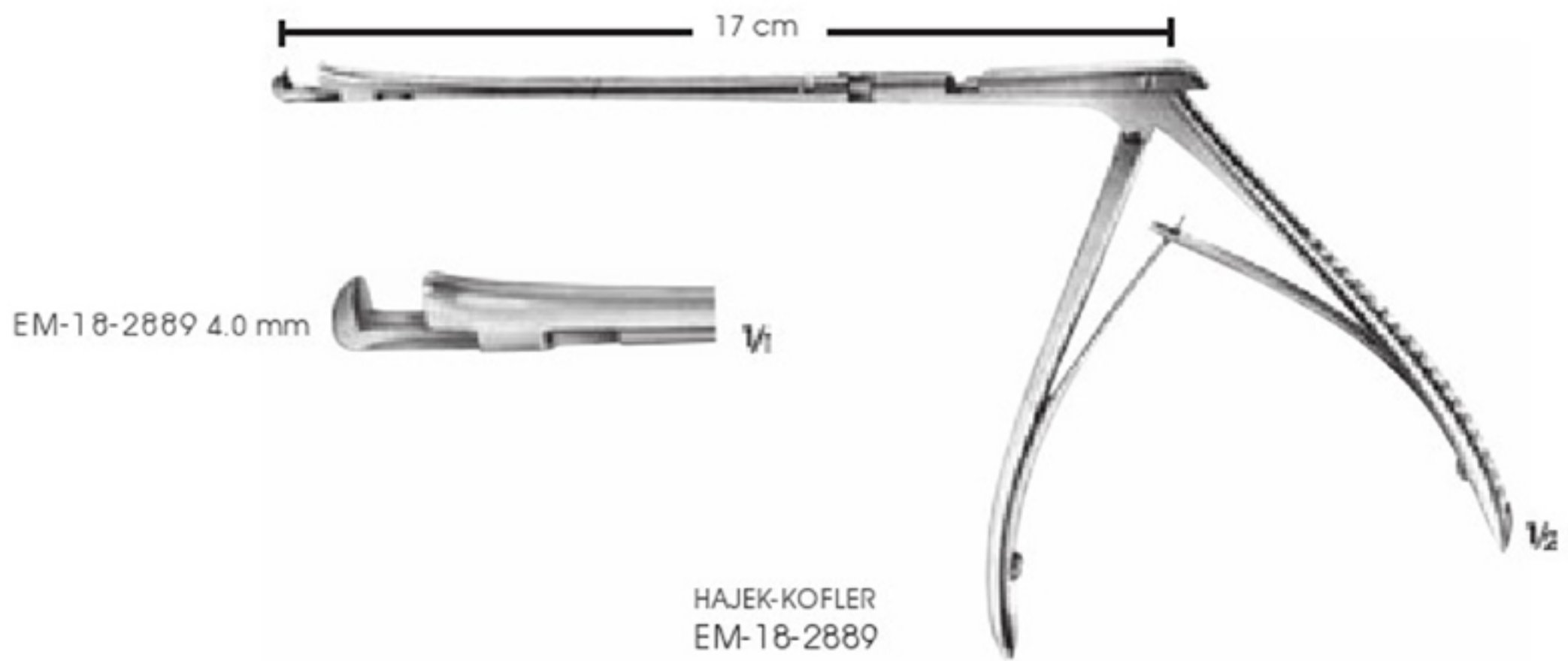

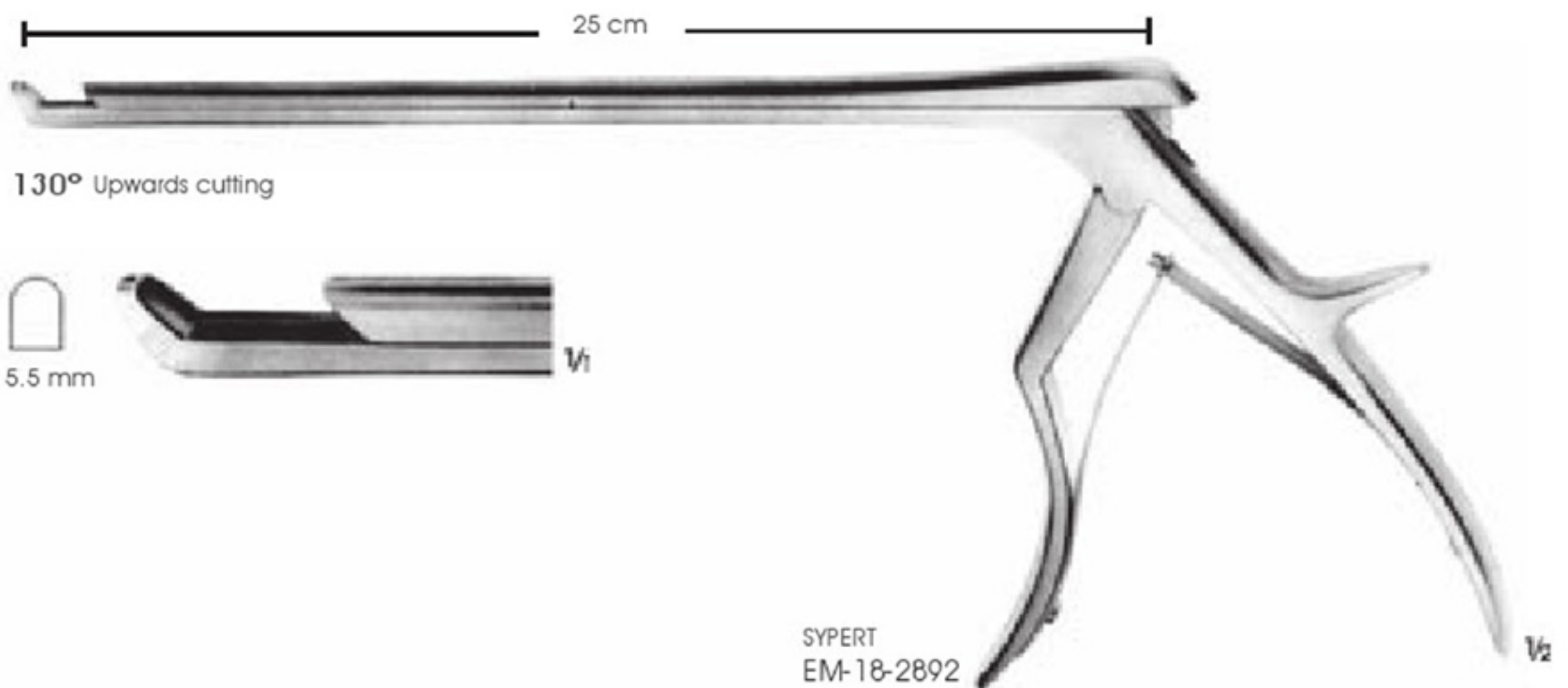
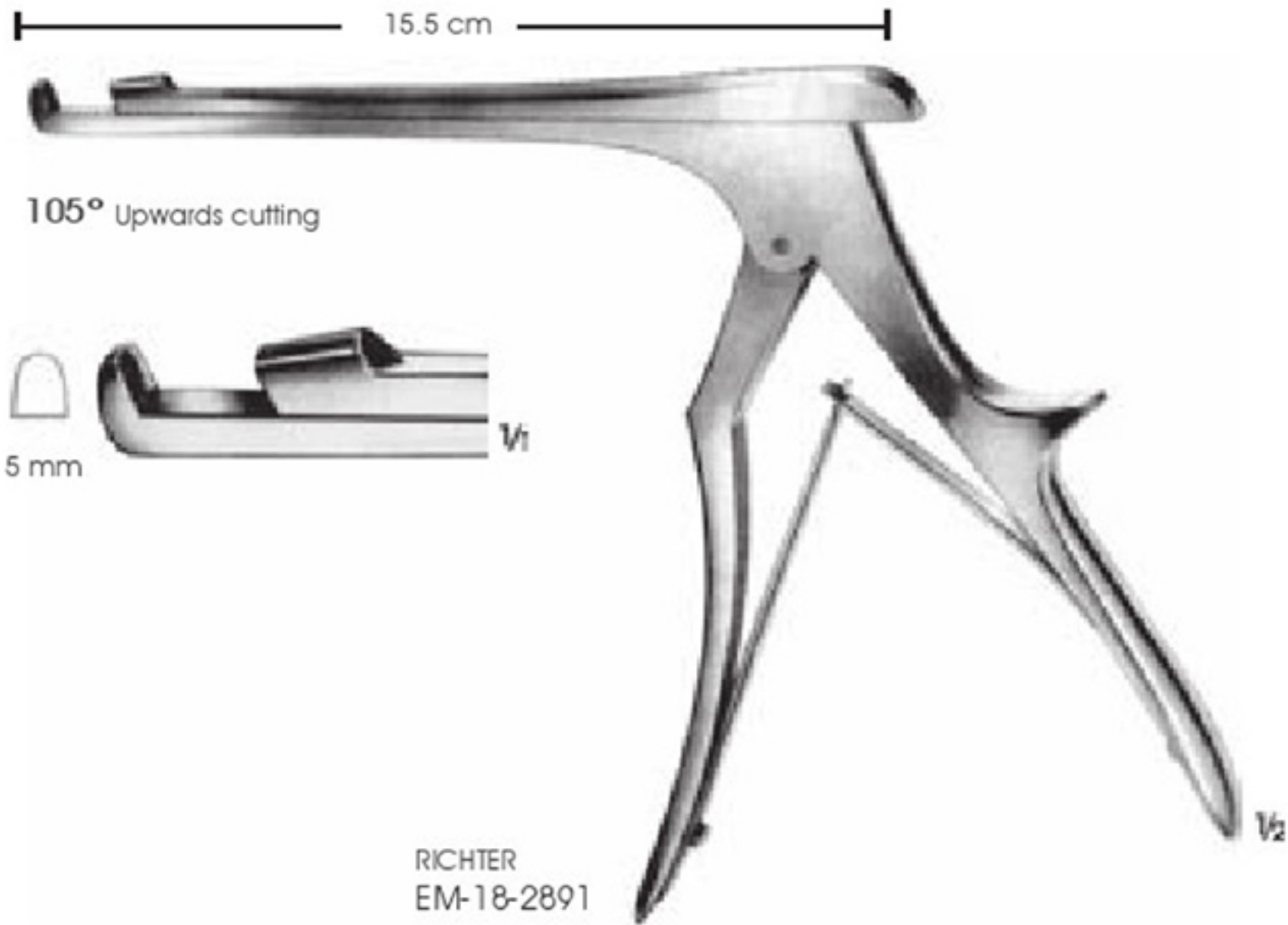



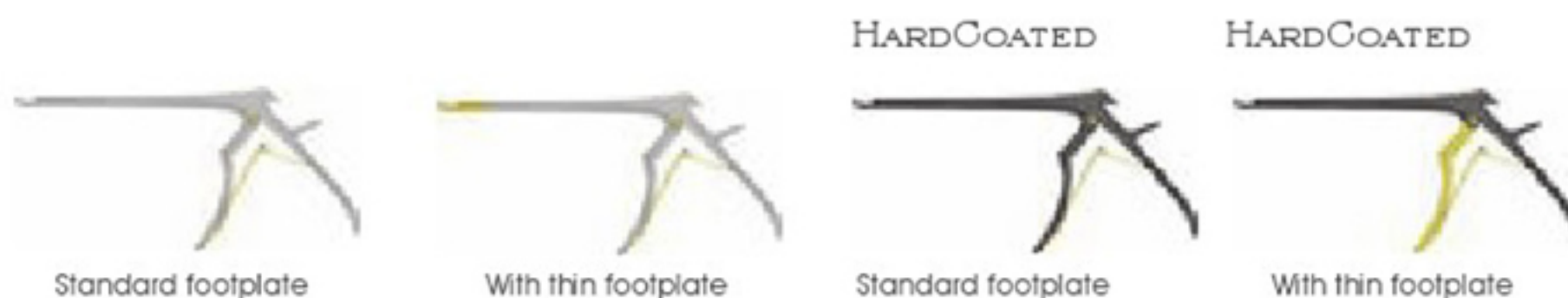



130° Upwards cutting



Length	Widht	Ejector	Detachable				
18 cm	1 mm		-	EM-18-2893-01	EM-18-2896-01	EM-18-2893-01B	EM-18-2896-01B
18 cm	2 mm		-	EM-18-2893-02	EM-18-2896-02	EM-18-2893-02B	EM-18-2896-02B
18 cm	3 mm		+	EM-18-2893-03	EM-18-2896-03	EM-18-2893-03B	EM-18-2896-03B
18 cm	4 mm		+	EM-18-2893-04	EM-18-2896-04	EM-18-2893-04B	EM-18-2896-04B
18 cm	5 mm		+	EM-18-2893-05	EM-18-2896-05	EM-18-2893-05B	EM-18-2896-05B
18 cm	6 mm		+	EM-18-2893-03	EM-18-2896-06	EM-18-2893-06B	EM-18-2896-06B
20 cm	1 mm		-	EM-18-2894-01	EM-18-2897-01	EM-18-2894-01B	EM-18-2897-01B
20 cm	2 mm		-	EM-18-2894-02	EM-18-2897-02	EM-18-2894-02B	EM-18-2897-02B
20 cm	3 mm		+	EM-18-2894-03	EM-18-2897-03	EM-18-2894-03B	EM-18-2897-03B
20 cm	4 mm		+	EM-18-2894-04	EM-18-2897-04	EM-18-2894-04B	EM-18-2897-04B
20 cm	5 mm		+	EM-18-2894-05	EM-18-2897-05	EM-18-2894-05B	EM-18-2897-05B
20 cm	6 mm		+	EM-18-2894-06	EM-18-2897-06	EM-18-2894-06B	EM-18-2897-06B
23 cm	2 mm		-	EM-18-2895-01	EM-18-2898-01	EM-18-2895-01B	EM-18-2898-01B
23 cm	3 mm		+	EM-18-2895-02	EM-18-2898-02	EM-18-2895-02B	EM-18-2898-02B
23 cm	4 mm		+	EM-18-2895-03	EM-18-2898-03	EM-18-2895-03B	EM-18-2898-03B
23 cm	5 mm		+	EM-18-2895-04	EM-18-2898-04	EM-18-2895-04B	EM-18-2898-04B

90° Upwards cutting



Length	Width	Ejector	Detachable		Standard	
						
18 cm	1 mm		-	EM-18-2899-01	EM-18-2899-01B	EM-18-2901-01
18 cm	2 mm		-	EM-18-2899-02	EM-18-2899-02B	EM-18-2901-02
18 cm	3 mm		+	EM-18-2899-03	EM-18-2899-03B	EM-18-2901-03
18 cm	4 mm		+	EM-18-2899-04	EM-18-2899-04B	EM-18-2901-04
18 cm	5 mm		+	EM-18-2899-05	EM-18-2899-05B	EM-18-2901-04
18 cm	6 mm		+	EM-18-2899-06	EM-18-2899-06B	EM-18-2901-05
23 cm	2 mm		-	EM-18-2900-01		
23 cm	3 mm		+	EM-18-2900-02		
23 cm	4 mm		+	EM-18-2900-03		
23 cm	5 mm		+	EM-18-2900-04		

90° Downwards cutting

Length	Width	Ejector	Detachable		Standard
					
18 cm	1 mm		-	EM-18-2902-01	EM-18-2903-01
18 cm	2 mm		-	EM-18-2902-02	EM-18-2903-02
18 cm	3 mm		+	EM-18-2902-03	EM-18-2903-03
18 cm	4 mm		+	EM-18-2902-04	EM-18-2903-04
18 cm	5 mm		+	EM-18-2902-05	EM-18-2903-05
18 cm	6 mm		+	EM-18-2902-06	EM-18-2903-06
23 cm	2 mm		-	EM-18-2902-01	
23 cm	3 mm		+	EM-18-2902-02	
23 cm	4 mm		+	EM-18-2902-03	
23 cm	5 mm		+	EM-18-2902-04	

130° Downwards cutting



Standard footplate



With thin footplate



Standard footplate















With thin footplate

Detachable

Standard



Length	Width	Ejector				
18 cm	1 mm	 -	EM-18-2904-01	EM-18-2905-01	EM-18-2906-01	EM-18-2907-01
18 cm	2 mm	 -	EM-18-2904-02	EM-18-2905-02	EM-18-2906-02	EM-18-2907-02
18 cm	3 mm	 +	EM-18-2904-03	EM-18-2905-03	EM-18-2906-03	EM-18-2907-03
18 cm	4 mm	 +	EM-18-2904-04	EM-18-2905-04	EM-18-2906-04	EM-18-2907-04
18 cm	5 mm	 +	EM-18-2904-05	EM-18-2905-05	EM-18-2906-05	EM-18-2907-05
21.5 cm	2 mm	 -			EM-18-2908-01	
21.5 cm	3 mm	 -			EM-18-2908-02	
21.5 cm	4 mm	 +			EM-18-2908-03	
21.5 cm	5 mm	 +			EM-18-2908-04	
23 cm	2 mm	 -	EM-18-2909-01		EM-18-2910-01	
23 cm	3 mm	 +	EM-18-2909-02		EM-18-2910-02	
23 cm	4 mm	 +	EM-18-2909-03		EM-18-2910-03	
23 cm	5 mm	 +	EM-18-2909-04		EM-18-2910-04	

130° Yukarıya doğru kesme/Upwards cutting



Standard footplate



With thin footplate

Standard

Length Wicht



18 cm	1 mm		EM-18-2911-01	EM-18-2912-01
18 cm	2 mm		EM-18-2911-02	EM-18-2912-02
18 cm	3 mm		EM-18-2911-03	EM-18-2912-03
18 cm	4 mm		EM-18-2911-04	EM-18-2912-04
18 cm	5 mm		EM-18-2911-05	EM-18-2912-05
18 cm	6 mm		EM-18-2911-06	EM-18-2912-06
20 cm	1 mm		EM-18-2913-01	EM-18-2914-01
20 cm	2 mm		EM-18-2913-02	EM-18-2914-02
20 cm	3 mm		EM-18-2913-03	EM-18-2914-03
20 cm	4 mm		EM-18-2913-04	EM-18-2914-04
20 cm	5 mm		EM-18-2913-05	EM-18-2914-05
20 cm	6 mm		EM-18-2913-06	EM-18-2914-06
21.5 cm	2 mm		EM-18-2915-01	
21.5 cm	3 mm		EM-18-2915-02	
21.5 cm	4 mm		EM-18-2915-03	
21.5 cm	5 mm		EM-18-2915-05	
23 cm	2 mm		EM-18-2916-01	EM-18-2917-01
23 cm	3 mm		EM-18-2916-02	EM-18-2917-02
23 cm	4 mm		EM-18-2916-03	EM-18-2917-03
23 cm	5 mm		EM-18-2916-04	EM-18-2917-04