



Neurosurgery

Neurochirurgie



CRUTCHFIELD
EM-20-2962-01
For children



CRUTCHFIELD
EM-20-2962-02
Medium size



GARDNER-WELLS
EM-20-2963
Maximum opening (16 cm)



EM-20-2962-04
Drill point, large
Ø 5 mm



EM-20-2962-03
Drill point, small
Ø 3.5 mm



EM-20-2964-02
Anastar/wrench



EM-20-2964-01
Large size Traction tongs with
adjustable pins and spanner
EM-20-2964-02

EM-20-2965-01
Complete
EM-20-2965-02 - 20-2965-13



EM-20-2965-03
Brace only



EM-20-2965-02
Extension piece only

HUDSON DOWNS
EM-20-2966-02
Brace only



HUDSON DOWNS
EM-20-2966-01
Extension piece

HUDSON
EM-20-2967-02
Hand drill



HUDSON
EM-20-2967-01
Extension piece only



CUSHING	CUSHING	CUSHING	McKENZIE	HUDSON	HUDSON	ADSON	HUDSON	HUDSON	EM-20-2965-13
EM-20-2965-04	EM-20-2965-05	EM-20-2965-06	EM-20-2965-07	EM-20-2965-08	EM-20-2965-09	EM-20-2965-10	EM-20-2965-11	EM-20-2965-12	EM-20-2965-13
Ø 10 mm	Ø 15 mm	Ø 14 mm	Ø 13 mm	Ø 14 mm	Ø 16 mm	Ø 15 mm	Ø 22 mm	Ø 9 mm	Ø 2 mm

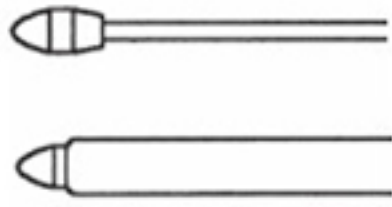

EM-20-2968-01 Ø 4 mm
 43.5 cm
 EM-20-2968-02 Ø 4 mm
 60 cm

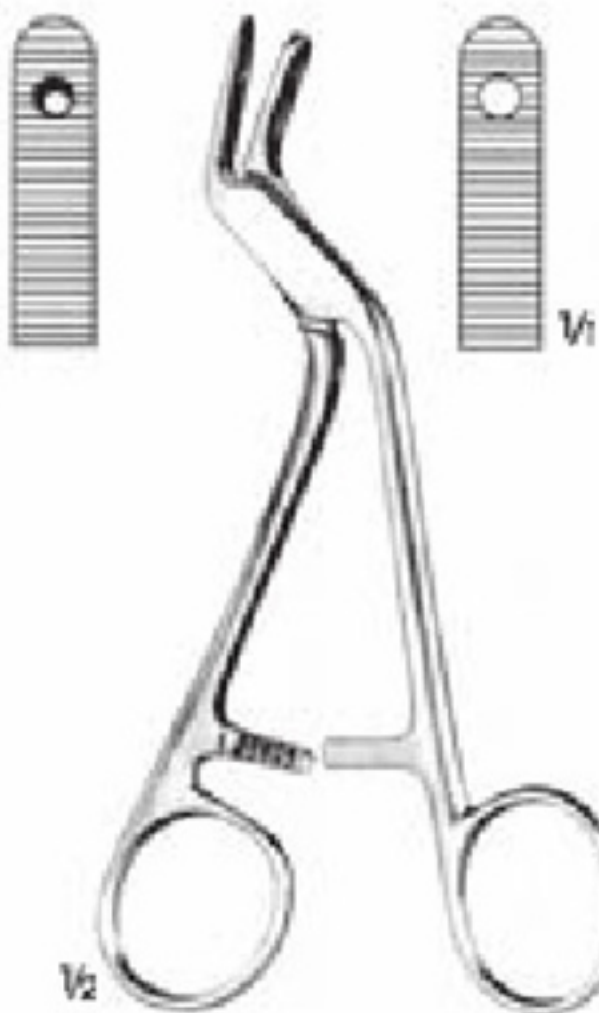

ADSON
 EM-20-2969
 15 cm



EM-20-2970
 Protection forceps
 20.5 cm



SWEET
 EM-20-2971-01 20 cm
 EM-20-2971-02 23 cm



GIGLI
EM-20-2972
Sap/Handle

1/1

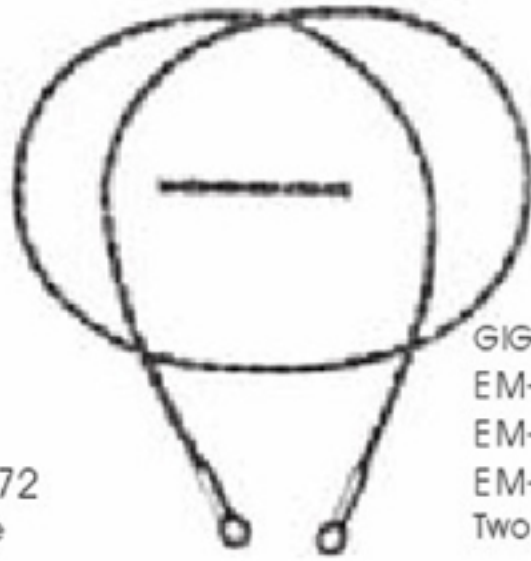

GIGLI
EM-20-2973-01 30 cm
EM-20-2973-02 40 cm
EM-20-2973-03 50 cm
Two windings

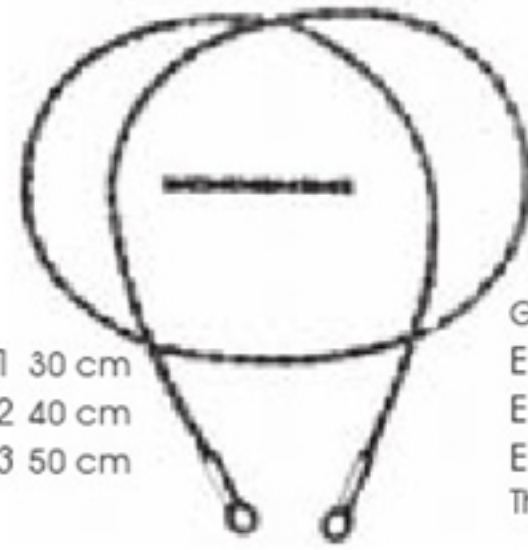

GIGLI
EM-20-2974-01 30 cm
EM-20-2974-02 40 cm
EM-20-2974-03 50 cm
Three winding



DE MARTEL
EM-20-2975 35 cm
Gigli saw for the flexible conductor wire

1/2



DAHLGREN
EM-20-2976-02



DE VILBISS
EM-20-2977
with 1 hook
20 cm

1/2



DAHLGREN
EM-20-2976-01
With 2 extra hooks
21 cm

1/2



Silikone Coated Brain Spatula
Malleable metal spatula with elastic silicone coating
Atraumatic retraction
For single use
1 package of 10 pieces



EM-20-2986-01 6 mm
20 cm

EM-20-2986-02 7.5 mm
20 cm

EM-20-2986-03 10 mm
20 cm

EM-20-2986-04 12.5 mm
20 cm

EM-20-2986-05 15 mm
20 cm



EM-20-2987-01 25°
15 cm
EM-20-2987-02 25°
20 cm
EM-20-2987-03 25°
28 cm



EM-20-2988-01 65°
20 cm
EM-20-2988-02 65°
28 cm



EM-20-2989-01 25°
15 cm
EM-20-2989-02 25°
20 cm
EM-20-2989-03 25°
28 cm



EM-20-2990-01 65°
20 cm
EM-20-2990-02 65°
8 cm

EM-20-2991-01 25°
20 cm
EM-20-2991-02 25°
28 cm



EM-20-2992-01 65°
20 cm
EM-20-2992-02 65°
28 cm



EM-20-2993-01 90°
20 cm
EM-20-2993-02 90°
28 cm



EM-20-2994-01 25°
20 cm
EM-20-2994-02 25°
28 cm



EM-20-2995-01 65°
20 cm
EM-20-2995-02 65°
28 cm



EM-20-2996-01 90°
20 cm
EM-20-2996-02 90°
28 cm



$\frac{1}{2}$
RANEY
EM-20-2997
16 cm



$\frac{1}{2}$
Mc $\frac{1}{2}$ KENZIE
EM-20-2998-01
15 cm

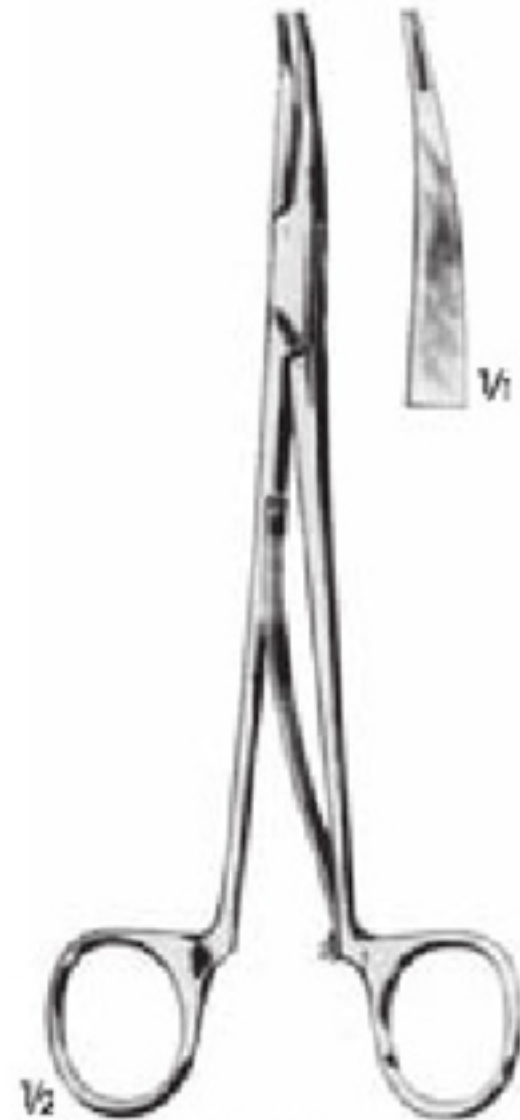

$\frac{1}{2}$
Mc KENZIE
EM-20-2998-02
19 cm

Spring hook for galea fixation with Bulldog clamp, to be fastened to covering drape.

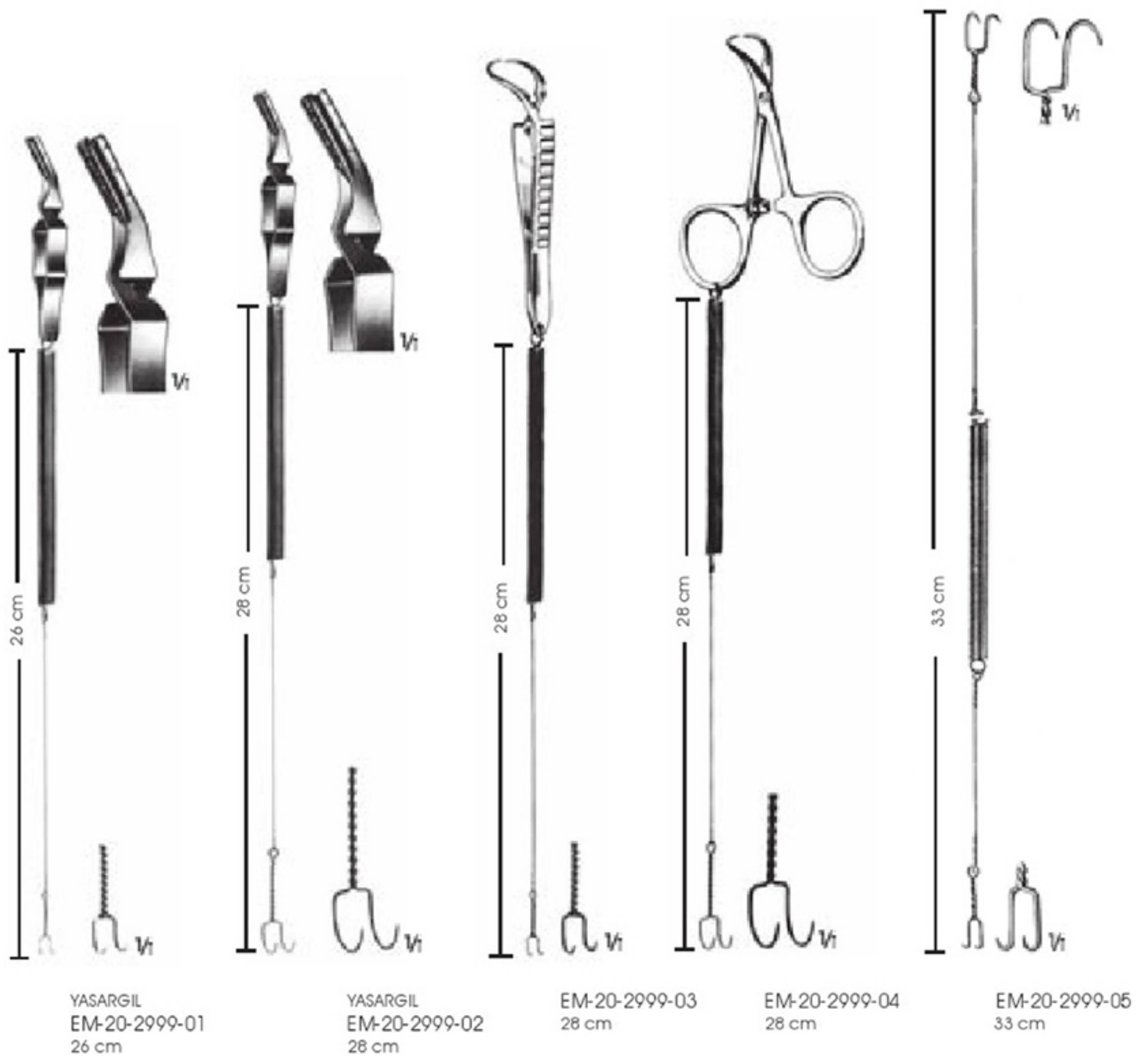





Vt

JACOBSON
EM-20-3003-01 - 3003-02
Probe with ball tip
18.5 cm



EM-20-3003-01 EM-20-3003-02



Vt

ASSMUS
EM-20-3004 \varnothing 3 mm
Probe with ball tip
39.5 cm



Vt

Vt



Vt

CASPAR
EM-20-3005
Ligature adjuster
23 cm



Vt

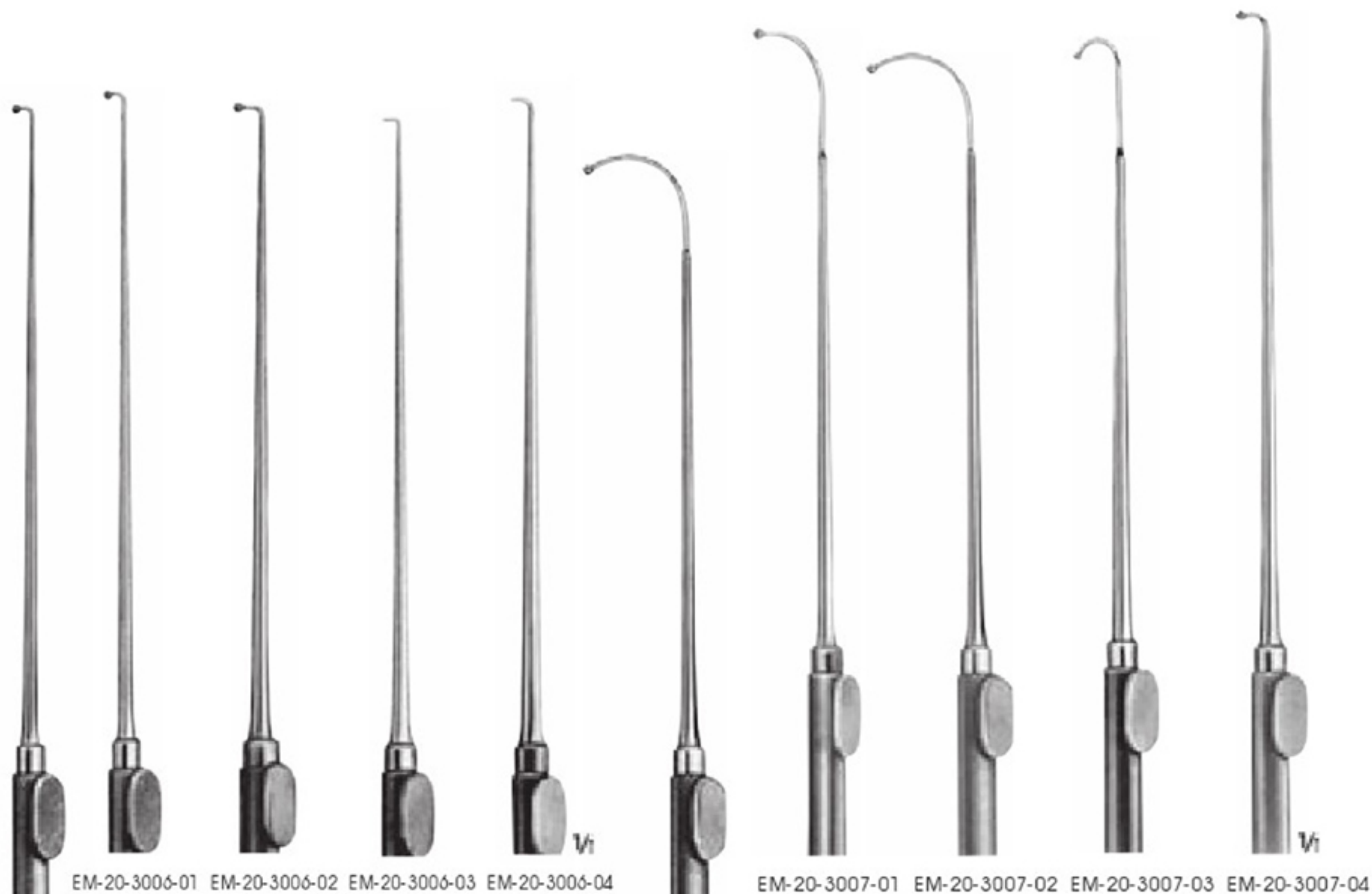

EM-20-3006-01 EM-20-3006-02 EM-20-3006-03 EM-20-3006-04

EM-20-3007-01 EM-20-3007-02 EM-20-3007-03 EM-20-3007-04

KRAYENBÜLH
EM-20-3006-01 - 3006-04
Nerve vessel hooks
18.5 cm

YASARGIL
EM-20-3007-01 - 3007-04
Probe pointed ligature guide
18.5 cm





EM-20-3012
Mirror handle
10.5 cm



EM-20-3013
Laryngeal mirror
12 cm



EM-20-3014
Laryngeal mirror with
Hexagonal handle
18 cm



YASARGIL
EM-20-3015 \varnothing 6 mm
Movable micro mirror
24 cm



EM-20-3016
Mirror
26 cm





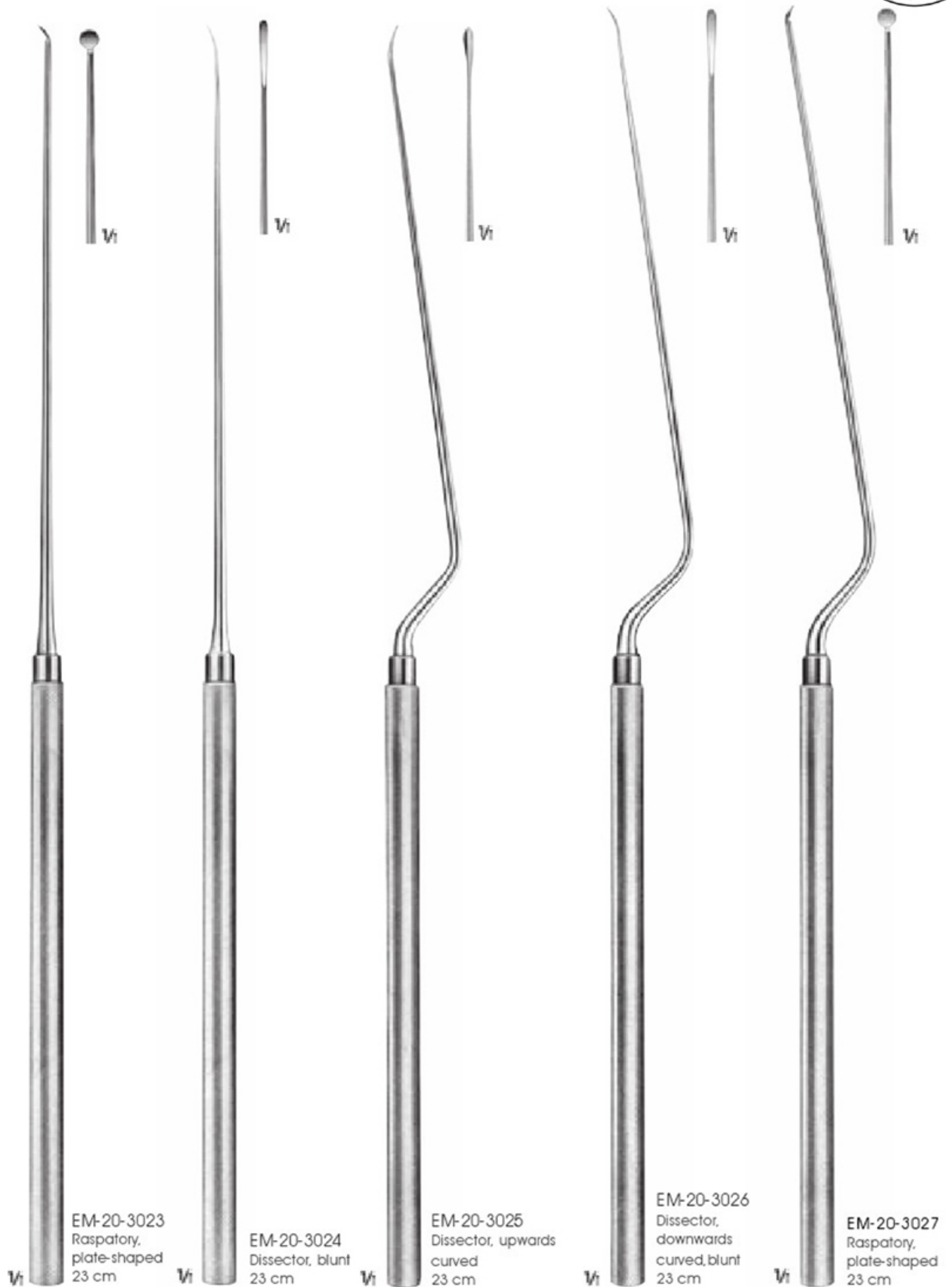

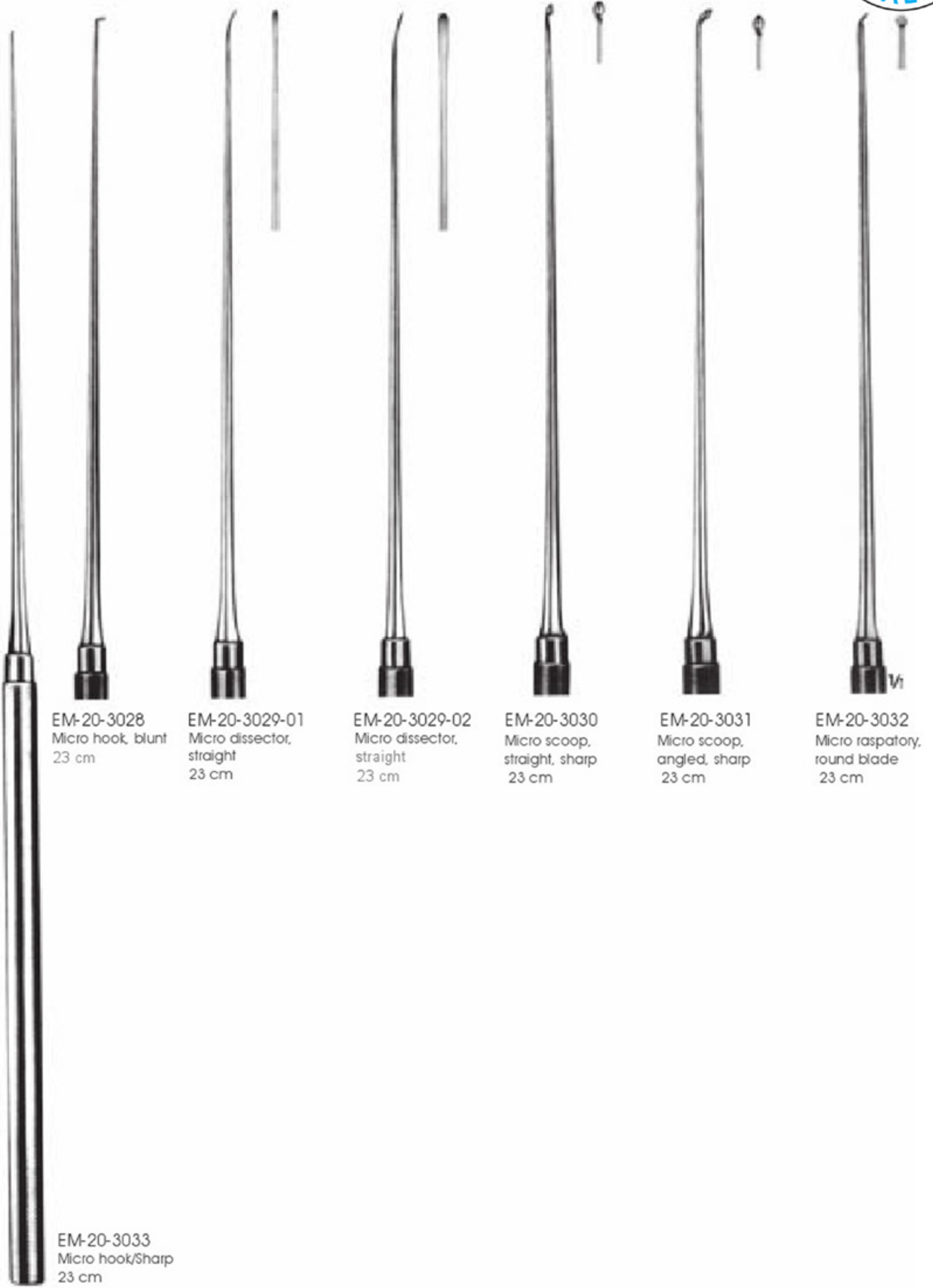

EM-20-3028
Micro hook, blunt
23 cm

EM-20-3029-01
Micro dissector,
straight
23 cm

EM-20-3029-02
Micro dissector,
straight
23 cm

EM-20-3030
Micro scoop,
straight, sharp
23 cm

EM-20-3031
Micro scoop,
angled, sharp
23 cm

EM-20-3032
Micro raspatory,
round blade
23 cm

EM-20-3033
Micro hook/Sharp
23 cm



YASARGIL
 EM-20-3034-01
 Micro raspatory,
 angled
 18.5 cm



YASARGIL
 EM-20-3034-02
 Micro dissector,
 angled
 18.5 cm



YASARGIL
 EM-20-3034-03
 Micro dissector,
 angled
 18.5 cm



YASARGIL
 EM-20-3034-04
 Micro raspatory,
 slightly curved
 18.5 cm



YASARGIL
 EM-20-3034-05
 Micro raspatory,
 curved
 18.5 cm



YASARGIL
 EM-20-3035-01
 Micro raspatory, down-
 wards curved
 18.5 cm

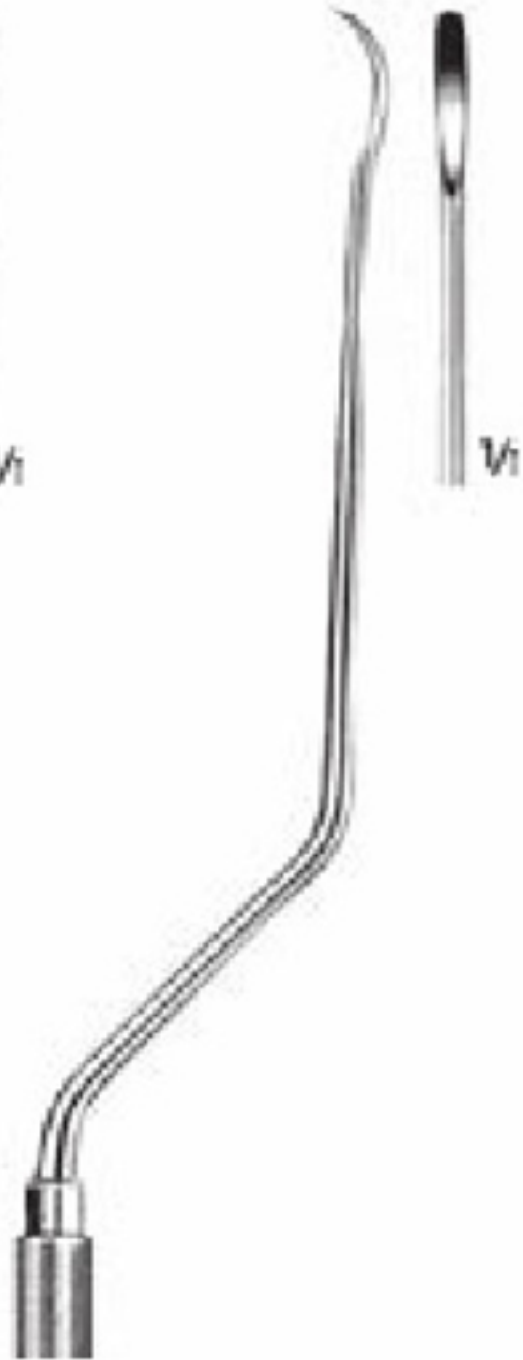

YASARGIL
 EM-20-3035-02
 Micro raspatory, downwards
 curved
 18.5 cm



YASARGIL
 EM-20-3035-03
 Micro raspatory, upwards
 curved
 18.5 cm

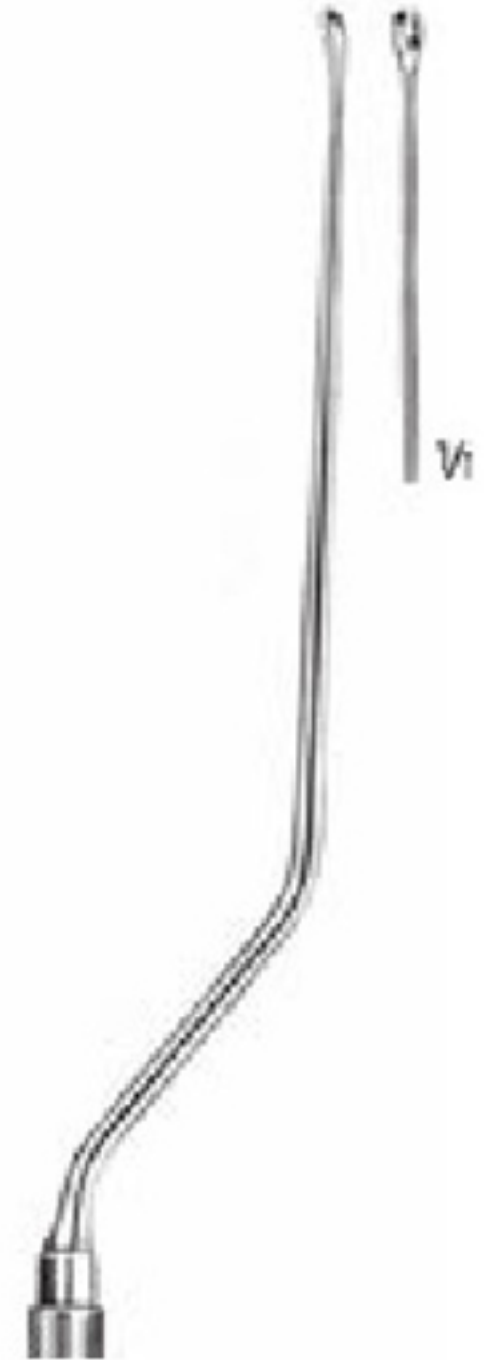

YASARGIL
 EM-20-3036
 Micro scoop
 18.5 cm



JACOBSON
EM-20-3037
Vessel knife
18.5 cm

EM-20-3038-01 - 3039-04
18.5 cm



KOOS
EM-20-3038-01
Curved upwards



KOOS
EM-20-3038-02
Curved downwards



KOOS
EM-20-3038-03
Curved upwards



KOOS
EM-20-3038-04
Curved downwards



KOOS
EM-20-3039-01
Curved downwards



KOOS
EM-20-3039-02
Curved upwards



YAŞARGIL
EM-20-3039-03
Curved downwards



YAŞARGIL
EM-20-3039-04
Curved upwards

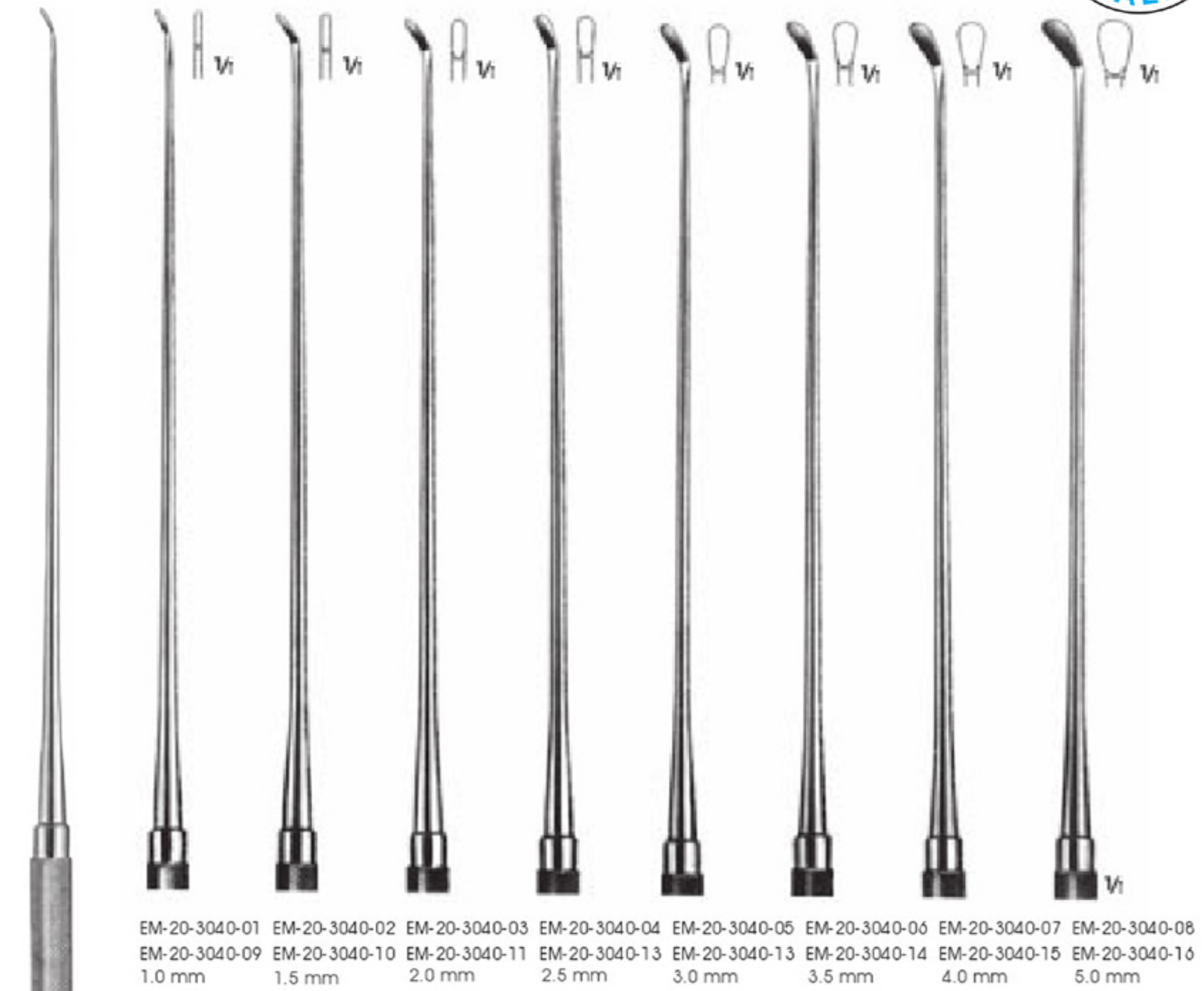

EM-20-3040-01	EM-20-3040-02	EM-20-3040-03	EM-20-3040-04	EM-20-3040-05	EM-20-3040-06	EM-20-3040-07	EM-20-3040-08	EM-20-3040-08
EM-20-3040-09	EM-20-3040-10	EM-20-3040-11	EM-20-3040-13	EM-20-3040-13	EM-20-3040-14	EM-20-3040-15	EM-20-3040-16	EM-20-3040-16
1.0 mm	1.5 mm	2.0 mm	2.5 mm	3.0 mm	3.5 mm	4.0 mm	5.0 mm	5.0 mm

SAMII
 EM-20-3040-01 - 3040-08
 20 cm
 EM-20-3040-09 - 3040-16
 23 cm

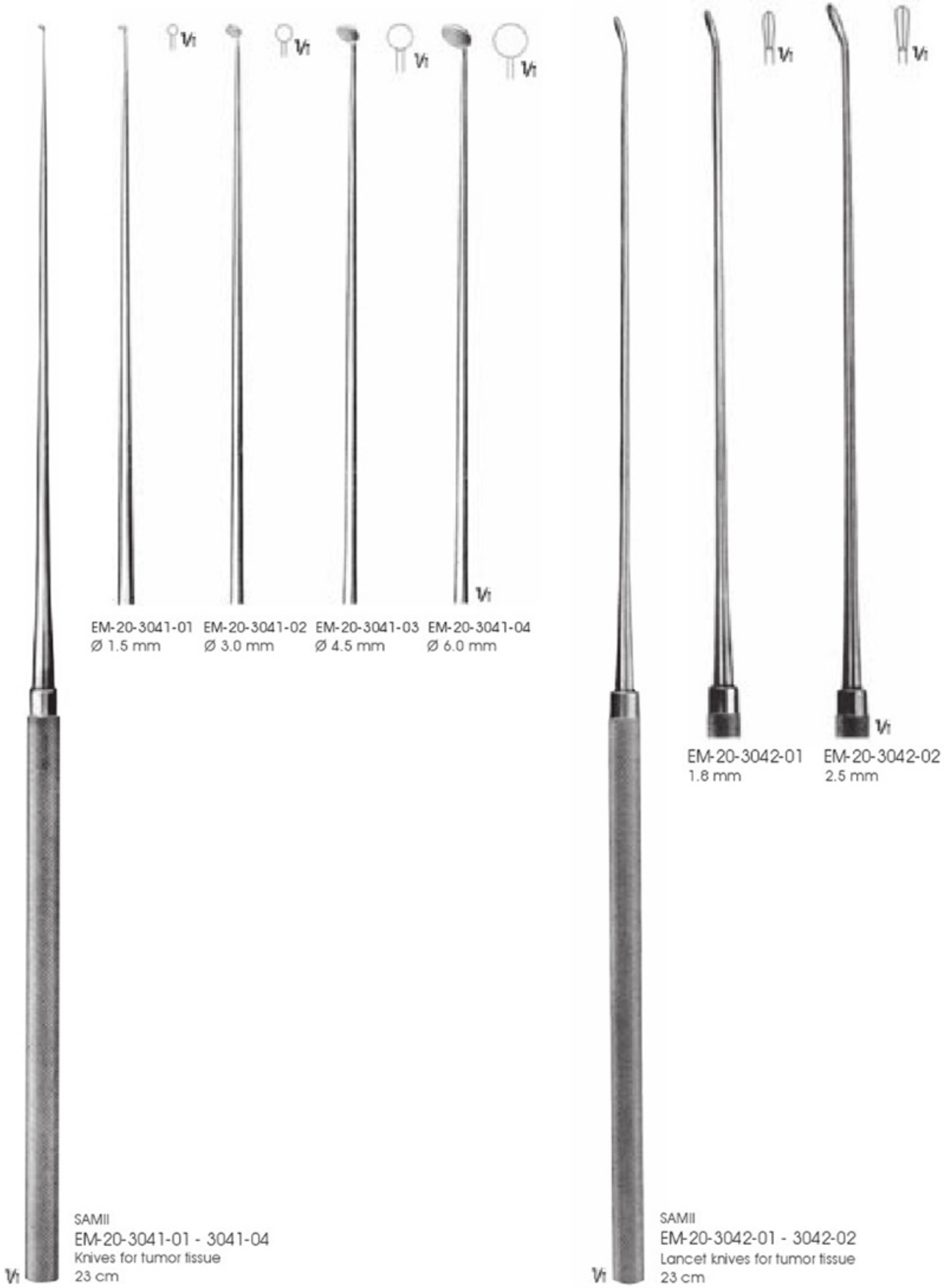

EM-20-3041-01 EM-20-3041-02 EM-20-3041-03 EM-20-3041-04
 Ø 1.5 mm Ø 3.0 mm Ø 4.5 mm Ø 6.0 mm

EM-20-3042-01 EM-20-3042-02
 1.8 mm 2.5 mm

SAMII
 EM-20-3041-01 - 3041-04
 Knives for tumor tissue
 23 cm

SAMII
 EM-20-3042-01 - 3042-02
 Lancet knives for tumor tissue
 23 cm



CASPAR
EM-20-3043
Micro knife, blunt tip
20 cm



CASPAR
EM-20-3044
Micro knife, blunt tip
20 cm



Blayd No.3
Blade No.3

EM-20-3045
Scalpel handle
21 cm



YASARGIL
EM-20-3046-01 Mini
EM-20-3046-02 Standard
17,5 cm



YASARGIL
EM-20-3047-01 Mini
EM-20-3047-02 Standard
17,5 cm

Mini Standard

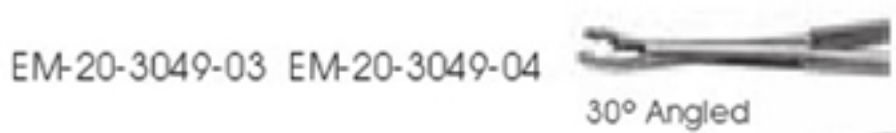
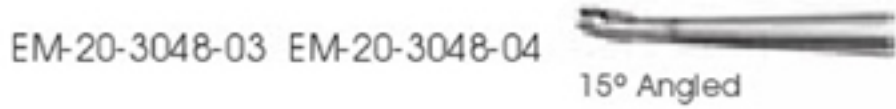
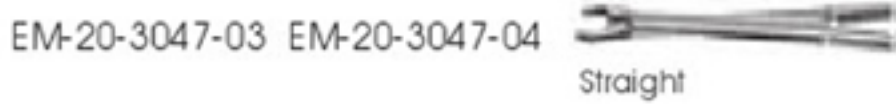

YASARGIL
EM-20-3047-03 - EM-20-047-04
EM-20-3048-03 - EM-20-048-04
EM-20-3049-03 - EM-20-049-04
21.5 cm

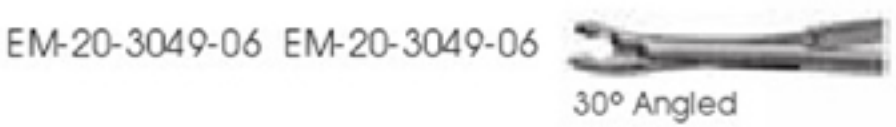
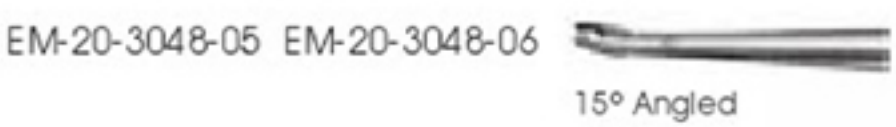
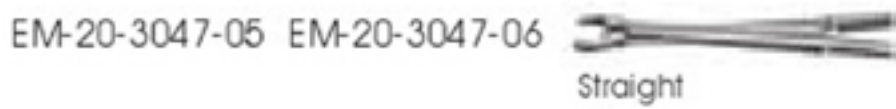

YASARGIL
EM-20-3047-05 - EM-20-047-06
EM-20-3048-05 - EM-20-048-06
EM-20-3049-05 - EM-20-049-06
23.5 cm



EM-20-3051
Alignment key



EM-20-3050-01 Mini
EM-20-3050-02 Standard
21.5 cm



YASARGIL
 EM-20-3052-01 Mini
 EM-20-3055-01 Standard
 18 cm



EM-20-3052-02 Mini EM-20-3055-02 Standard 22 cm	EM-20-3053-02 Mini EM-20-3056-02 Standard 22 cm	EM-20-3054-02 Mini EM-20-3057-02 Standard 22 cm
---	---	---

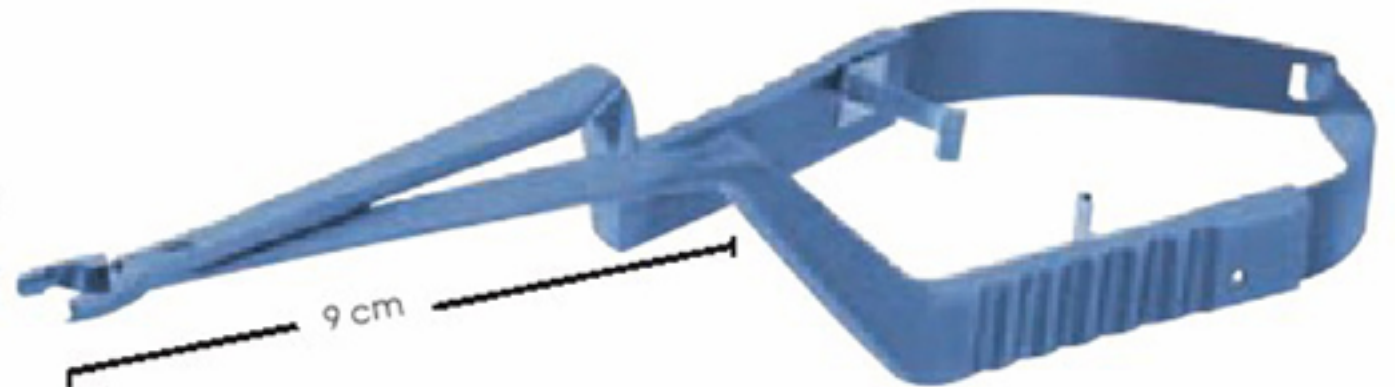

YASARGIL
 EM-20-3052-02 - EM-20-3055-02
 EM-20-3053-02 - EM-20-3056-02
 EM-20-3054-02 - EM-20-3057-02

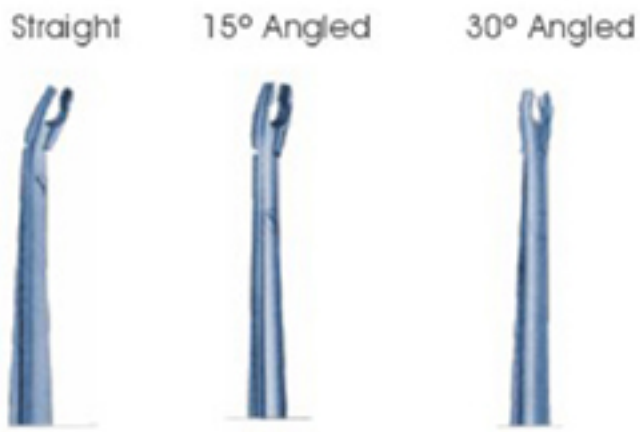

EM-20-3052-03 Mini EM-20-3055-03 Standard 25 cm	EM-20-3053-03 Mini EM-20-3056-03 Standard 25 cm	EM-20-3054-03 Mini EM-20-3057-03 Standard 25 cm
---	---	---

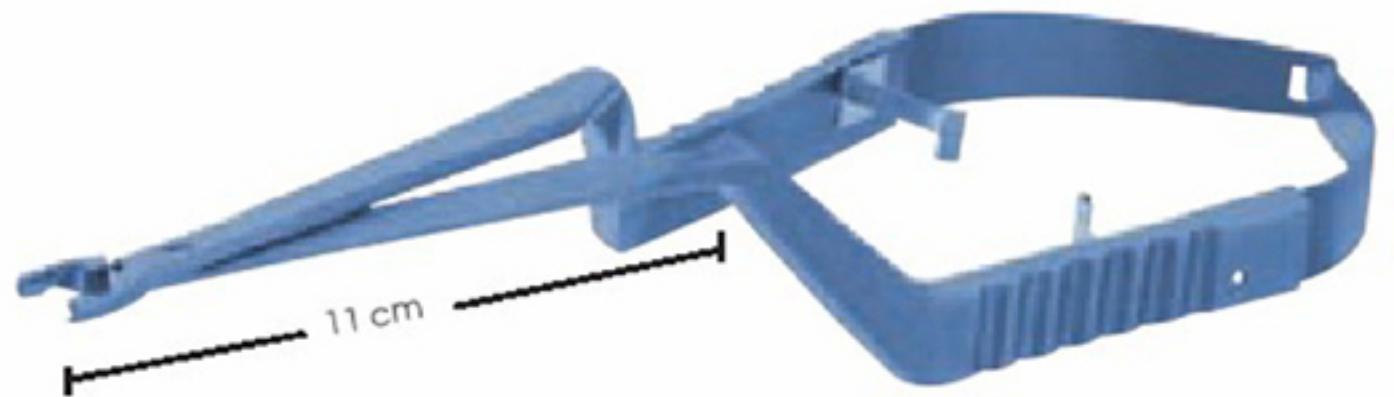

YASARGIL
 EM-20-3052-03 - EM-20-3055-03
 EM-20-3053-03 - EM-20-3056-03
 EM-20-3054-03 - EM-20-3057-03

Mini EM-20-3058-01	Standard EM-20-3059-01
-----------------------	---------------------------



EM-20-3058-02	EM-20-3059-02
---------------	---------------



EM-20-3058-03	EM-20-3059-03
---------------	---------------

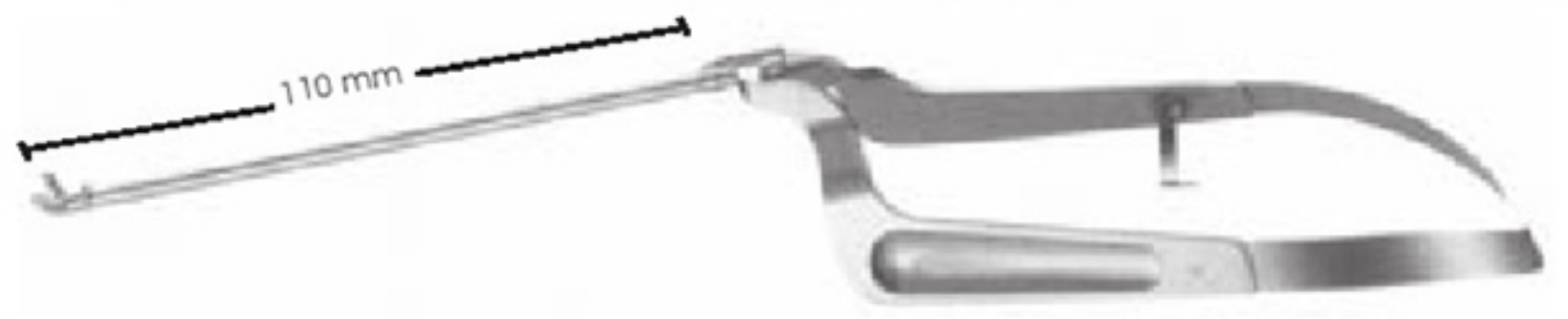



YASARGIL
 EM-20-3060-01
 Self-retaining brain retractor, with 1 flexible arm, complete, consisting of:
 EM-20-3060-05 Fixation base
 EM-20-3060-03 Flexible arm only
 EM-20-3060-03 Support for spatula

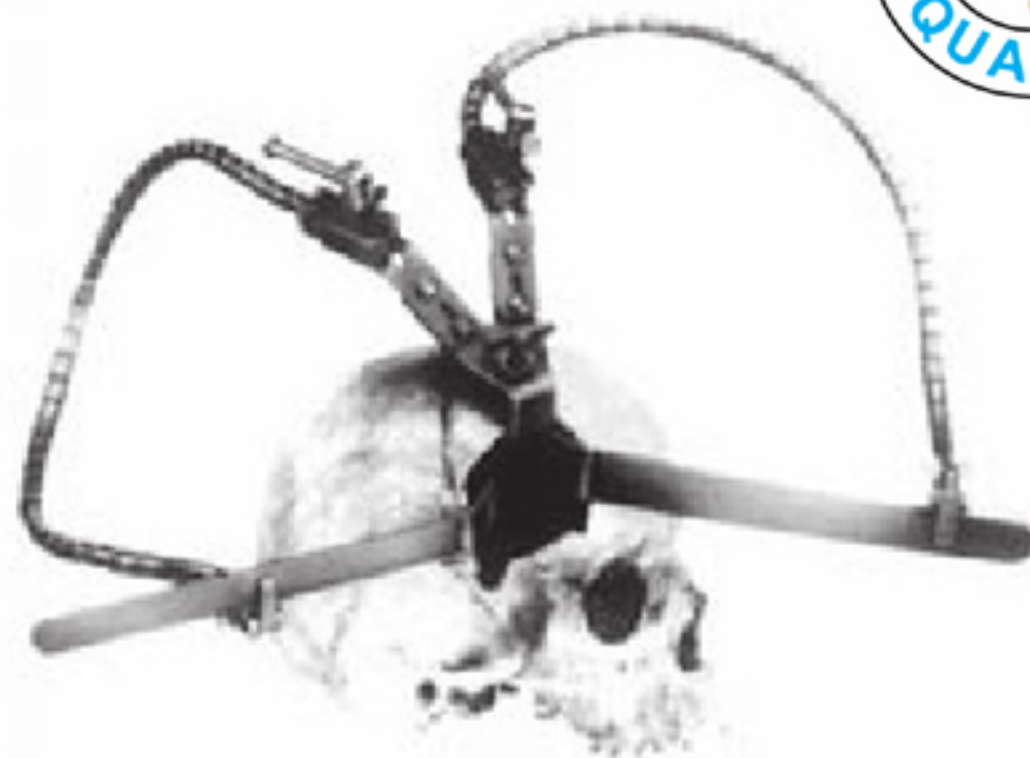

YASARGIL
 EM-20-3060-02
 Self-retaining brain retractor, with 1 flexible arm, complete, consisting of:
 EM-20-3060-05 Fixation base (1 each)
 EM-20-3060-03 Flexible arm only (2 each)
 EM-20-3060-03 Support for spatula (2 each)



EM-20-3060-04
 Fixation base



YASARGIL
 EM-20-3060-03
 Flexible arm only



EM-20-3060-05
 Fixation base



EM-20-3060-06
 Fixation base



EM-20-3060-07
 Support only



EM-20-3060-08
 Support only

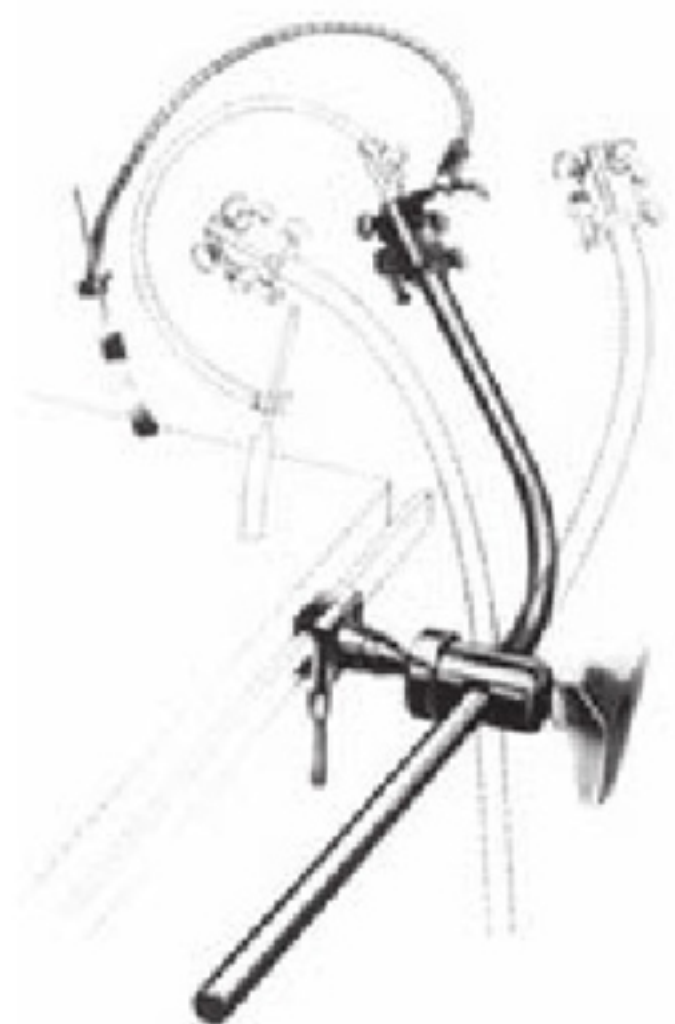

EM-20-3060-09
 EM-20-3060-13 Ball-and socket joint
 EM-20-3060-16 Holding rod
 EM-20-3060-12 Coupling head
 EM-20-3060-03 Flexible arm only
 EM-20-3060-08 Support for spatula

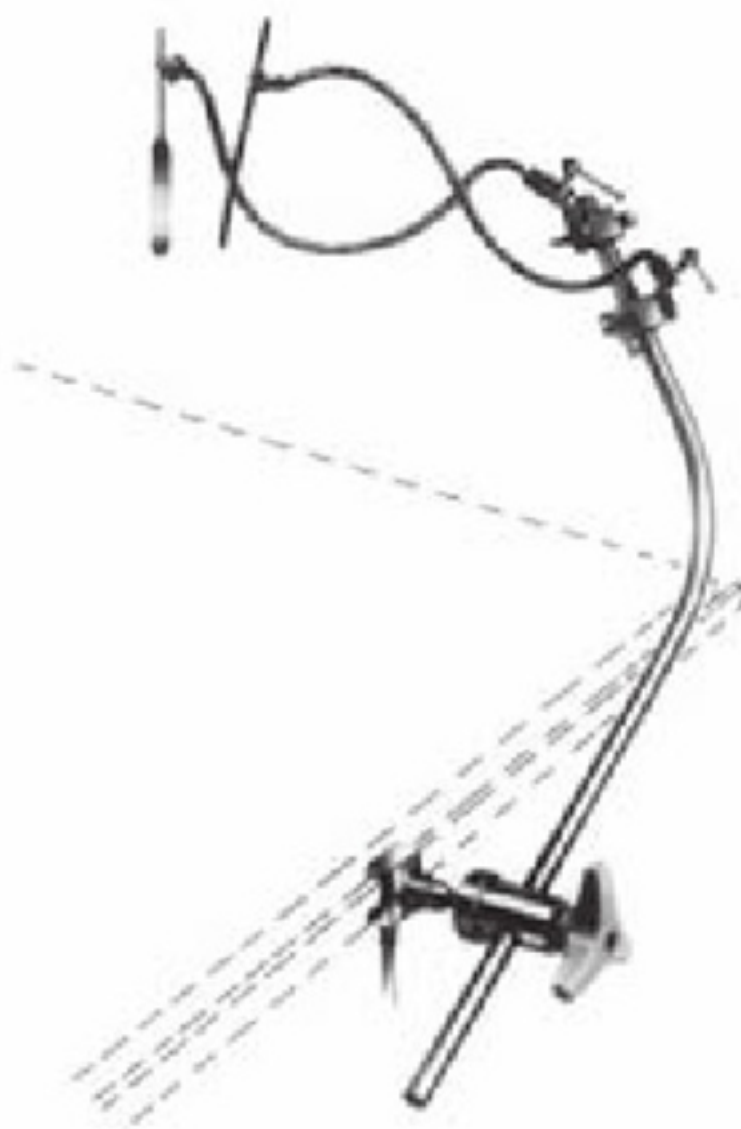

EM-20-3060-10
 EM-20-3060-13 Ball-and socket joint
 EM-20-3060-16 Holding rod
 EM-20-3060-14 Coupling head (2 each)
 EM-20-3060-03 Flexible arm only (2 each)
 EM-20-3060-07 Support for spatula
 EM-20-3060-08 Support for spatula



EM-20-3060-12
 Coupling head



EM-20-3060-11
 Joint for table fixation
 maximum 9 x 32 mm

EM-20-3060-13
 Joint for table fixation
 10 x 25 mm



EM-20-3060-14
 Turnable coupling head



EM-20-3060-15
 Turnable coupling head



EM-20-3060-16
 Holding rod

EM-20-3061-12



EM-20-3061-11

EM-20-3061-10

GILSBACH

EM-20-3061-01 Complete
Basic unit

EM-20-3061-10 Holding rod

EM-20-3061-11 Semi-circular basic bar, for flexible arms

EM-20-3061-12 Frame for Galea hook

GILSBACH RETRACTOR SYSTEM

EM-20-3061-01 Complete

EM-20-3062-01 4 Each

EM-20-3060-07 2 Each

EM-20-3060-15 1 Each

EM-20-3060-16 1 Each

EM-20-3060-50 1 Each

EM-20-3061-00 1 Each

EM-20-3061-02 1 Each

EM-20-3061-08 1 Each

EM-20-3060-37 1 Each

EM-20-3060-39 1 Each

EM-20-3063-01 1 Each

EM-20-3063-02 1 Each



EM-20-3061-02 Table Fixation attachment



EM-20-3061-08 Complete
 EM-20-3061-03 Table Fixation attachment (1 adet)
 EM-20-3061-05 Table Fixation attachment (1 pcs)

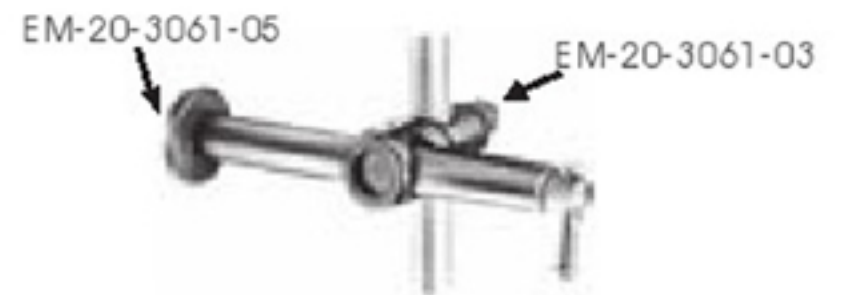

EM-20-3061-03 Table Fixation attachment
 EM-20-3060-35 Holding rod
 EM-20-3060-29 Joint for table fixation 9 x 32 mm
 EM-20-3060-32 Joint for table fixation 10 x 25 mm



EM-20-3060-39 Holder for forceps

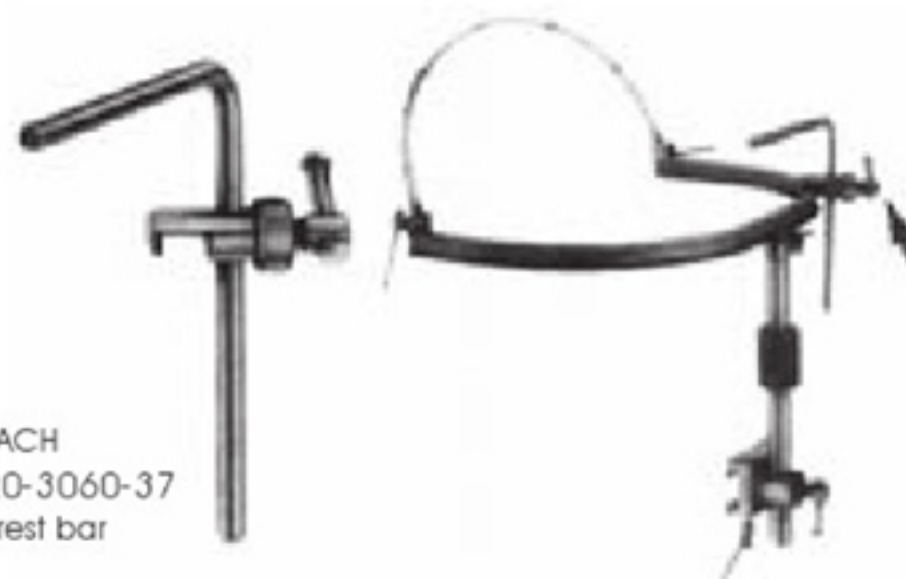

GILSBACH
 EM-20-3060-37 Handrest bar



EM-20-3060-06 15 cm
 EM-20-3060-07 20 cm
 EM-20-3060-08 25 cm
 Flexible arm

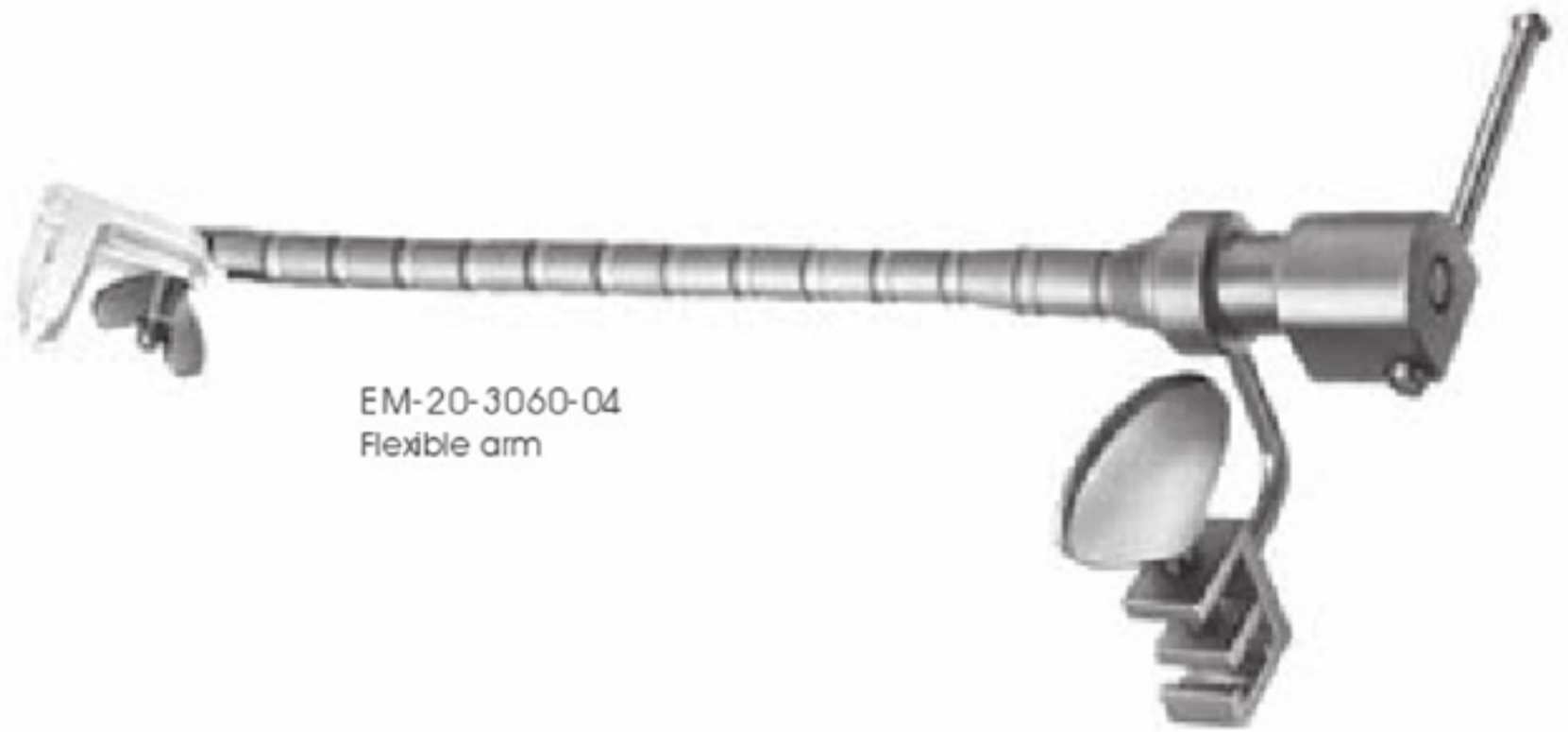

EM-20-3060-04
 Flexible arm



EM-20-3060-15
 Support only



EM-20-3060-16
 Support only

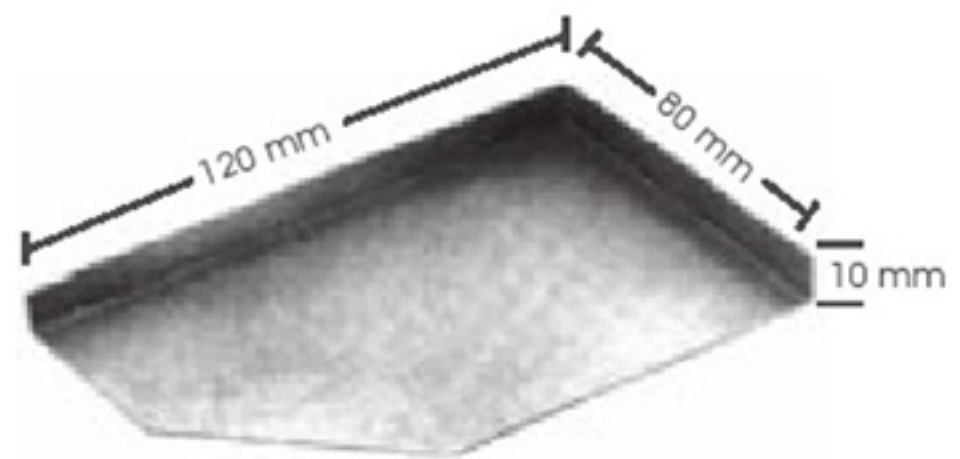

EM-20-3060-50
 Tray can be to the EM-20-3060-05
 and EM-20-3060-15



EM-20-3062-02
 Chain hook (Used to EM-20-3061-12)



EM-20-3064
 Spring hook (Used to EM-20-3061-12)



MAYFIELD
EM-20-3065-01
Skull clamp



GARDNER
EM-20-3065-20 10 mm
Adult size
25 mm



MAYFIELD
EM-20-3065-06
Adult size



MAYFIELD
EM-20-3065-07
Child size



GARDNER
EM-20-3065-21 6 mm
Child size
38 mm



MT.SINAI
EM-20-3065-22 10 mm
Child size
38 mm



Set for fixing skull clamp

MAYFIELD
EM-20-3065-01
Skull clamp

MAYFIELD
EM-20-3065-16
Table fixation attachment

MAYFIELD
EM-20-3065-05
Table fixation attachment

MAYFIELD
EM-20-3065-4
Table fixation attachment

MAYFIELD
EM-20-3065-02
Table fixation attachment

MAYFIELD
EM-20-3065-00 Complete
EM-20-3065-01 Skull clamp
EM-20-3065-04 Table fixation attachment
EM-20-3065-05 Table fixation attachment
EM-20-3065-02 Table fixation bar
EM-20-3065-16 Table fixation attachment
EM-20-3065-04 Masa Table fixation attachment (2 each)



MAYFIELD
EM-20-3066
Table fixation attachment

EM-20-3067-01 Complete
EM-20-3067-02 1 each
EM-20-3067-03 1 each
EM-20-3067-06 1 each
Headrest pediatric with extension bar

EM-20-3067-06
Extension bar

EM-20-3067-02
Headrest title, right

EM-20-3067-03
Headrest title, left

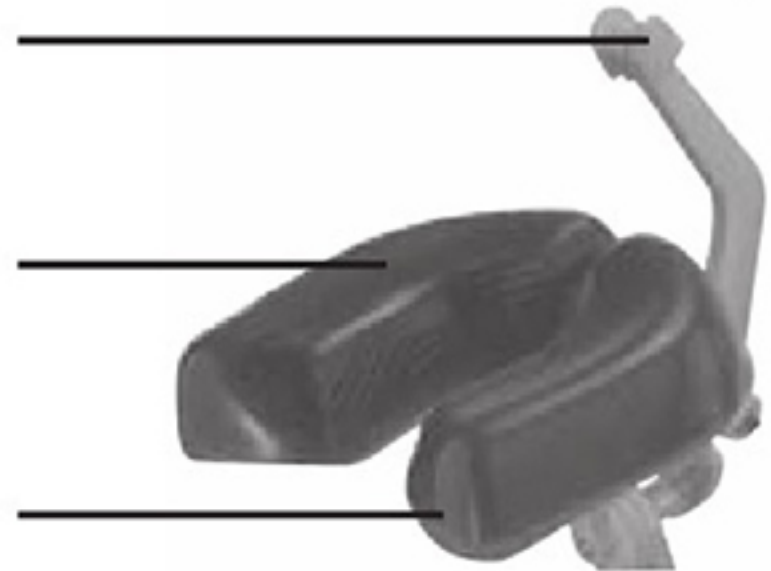

EM-20-3067-01 Complete
EM-20-3067-04 1 each
EM-20-3067-05 1 each
EM-20-3067-07 1 each
Adults with headrest extension bar

EM-20-3067-07
Extension bar

EM-20-3067-04
Headrest title, right

EM-20-3067-05
Horseshoe title, left



EM-20-3067-10
Gel ear ring base 90 mm



EM-20-3067-12
Gel ear ring base 90 mm



EM-20-3067-14
Gel head ring base 140 mm



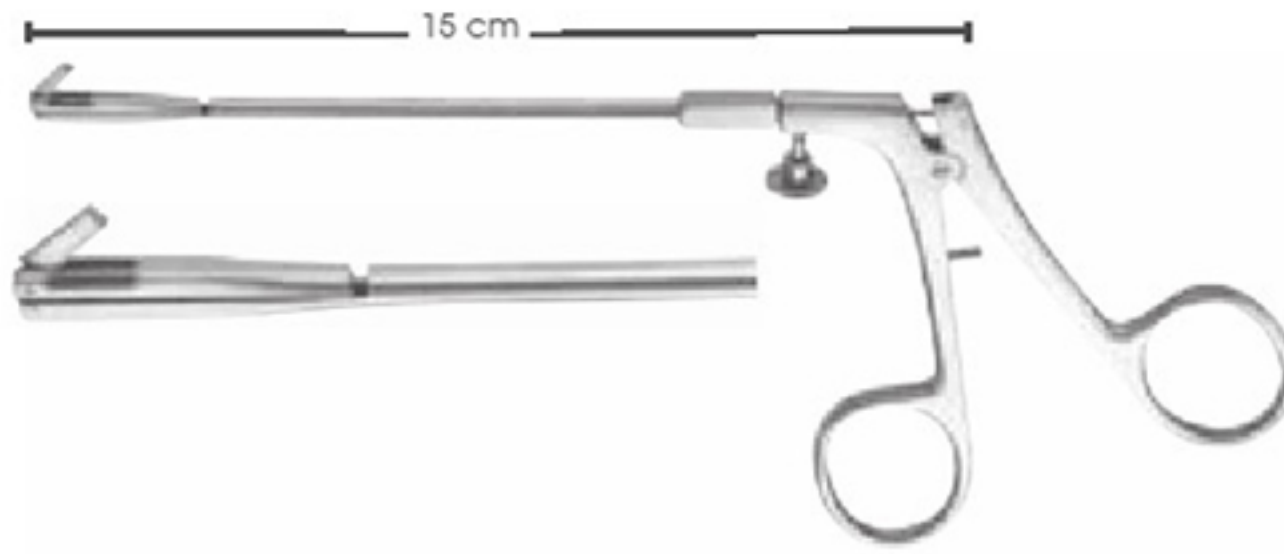

EM-20-3068
Antrum punch

HARDCOATED



EM-20-3070
Key
15 cm

PAPAVERO-CASPAR
EM-20-3069-01 80 x 11 mm
EM-20-3069-02 90 x 13 mm
EM-20-3069-03 100 x 15 mm



With key EM-20-3070
Slim profile and lightweighted specula for transsphenoidal



EM-20-3069-04 90 x 13 mm
Transsphenoidal specula



PAPAVERO-HARTMANN
EM-20-3071
Use with EM-20-3069-01, EM-20-3069-02, EM-20-3069-03



COTTLE
EM-20-3072-01 - 3072-02
Nasal speculum
Use with EM-20-3069-01, EM-20-3069-02, EM-20-3069-03
13.5 cm



EM-20-3072-01
76 x 7 mm

EM-20-3072-02
90 x 7 mm



CUSHING-LANDOLT
EM-20-3073-01 70 x 15 mm
EM-20-3073-02 90 x 15 mm
EM-20-3073-03 110 x 15 mm
Specula for transsphenoidal hypophysectomy



JANSEN-MIDDLETON
EM-20-3074
20 cm



EM-20-3075-01

COTTLE
EM-20-3075-01 4 mm
EM-20-3075-02 7 mm
EM-20-3075-03 9 mm
EM-20-3075-04 12 mm
Chisel with depth markings
18 cm



PAPAVERO
EM-20-3076
Bayonet chisel, 4 mm
22 cm



LANDOLT
EM-20-3077
Spreader for specula
EM-20-3073-01 - EM-20-3073-03
21 cm



∅ 30 mm

COTTLE
EM-20-3078 240 gr
Mallet, 1 side flat, 1
side convex
18.5 cm

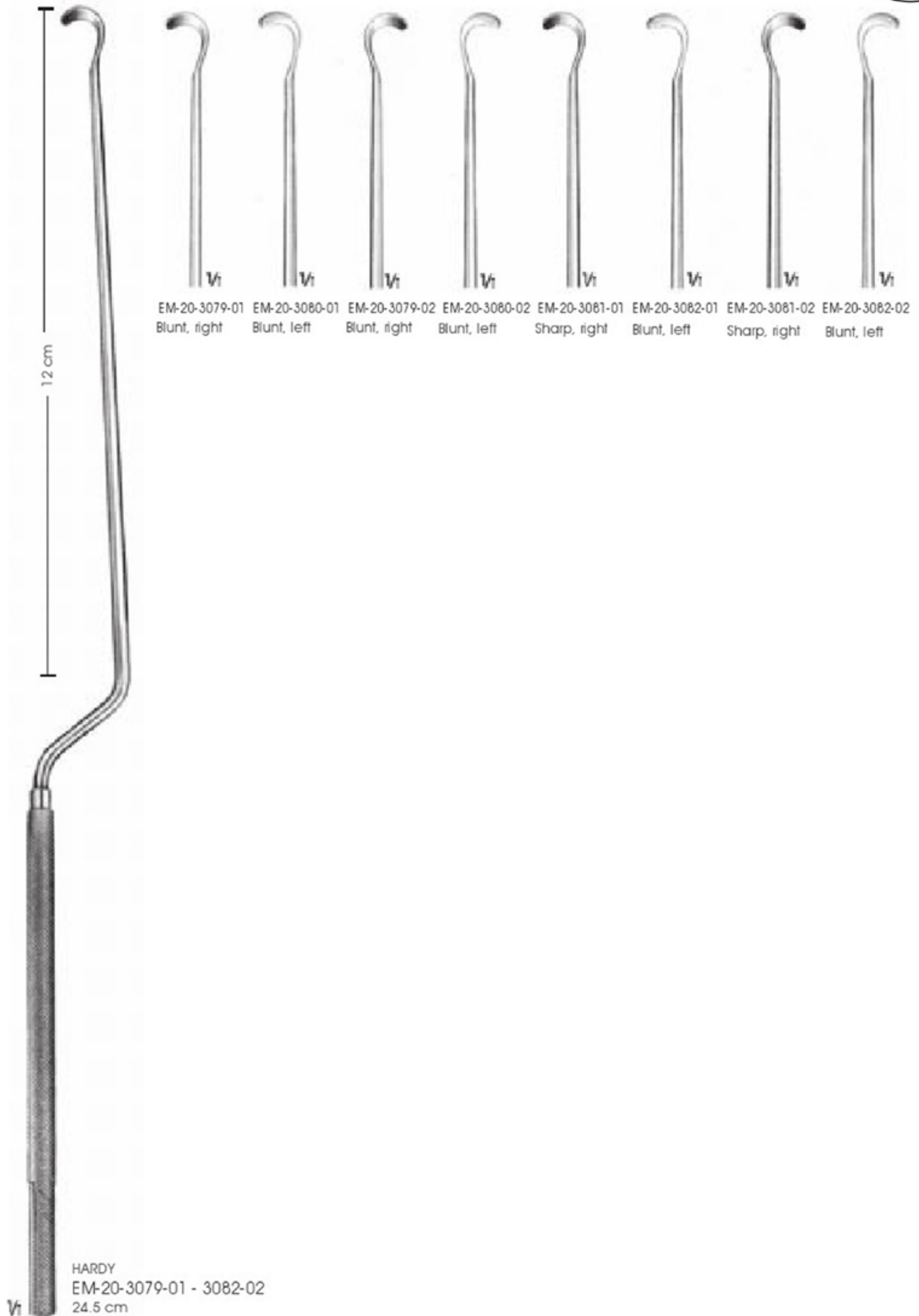



Vi

LANDOLT
EM-20-3083-01 Blunt, right
EM-20-3084-00 Blunt, left
Malleable
26 cm



Vi

LANDOLT
EM-20-3083-01
Blunt, right
26 cm
EM-20-3084-01
Blunt, left
Malleable
26 cm



Vi

Vi

LANDOLT
EM-20-3085
Curette, malleable
26 cm



Vi

Vi

LANDOLT
EM-20-3086
Spoon, malleable
26 cm



Vi

LANDOLT
EM-20-3087
Blunt hook
Malleable
26 cm

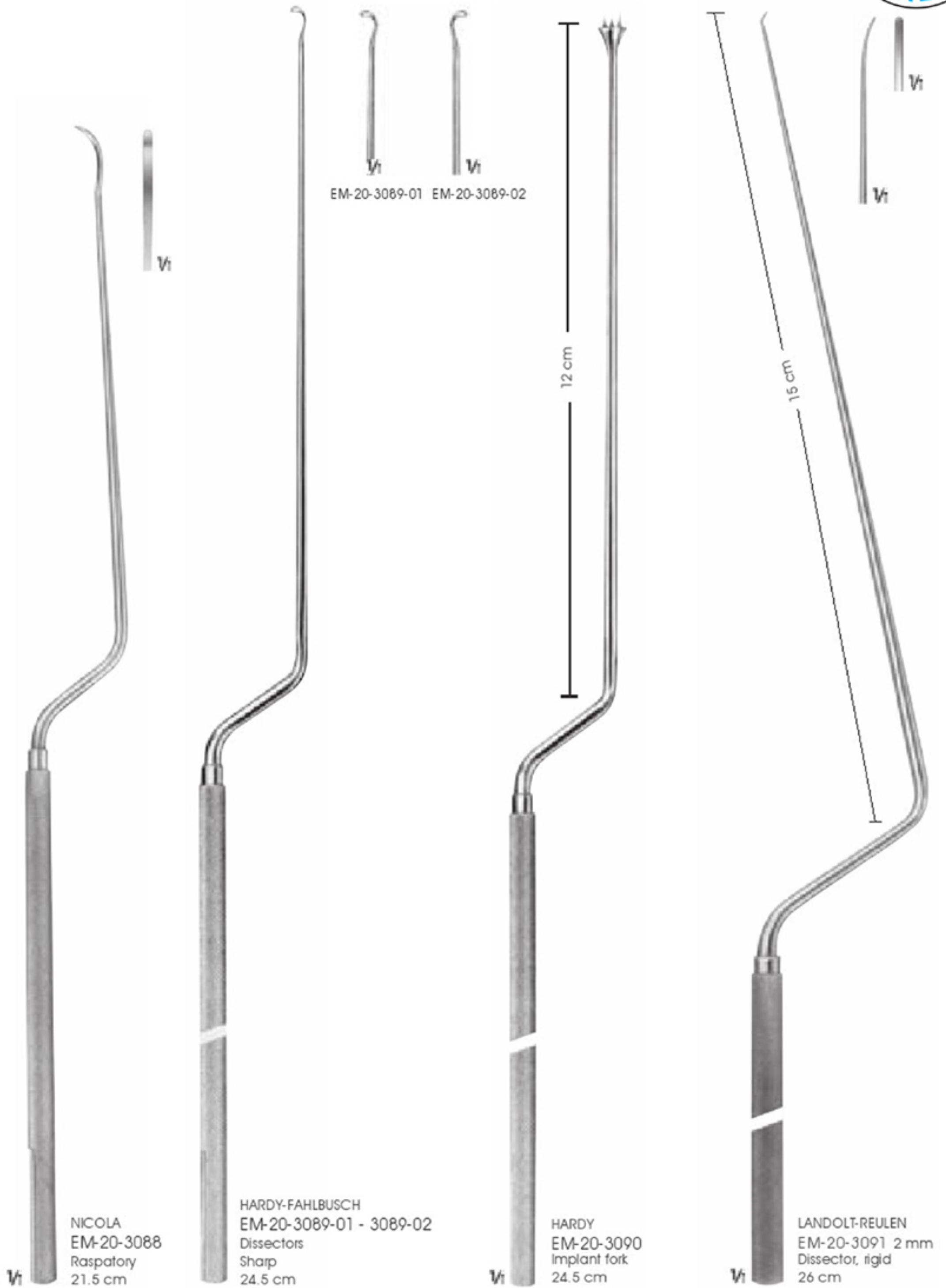

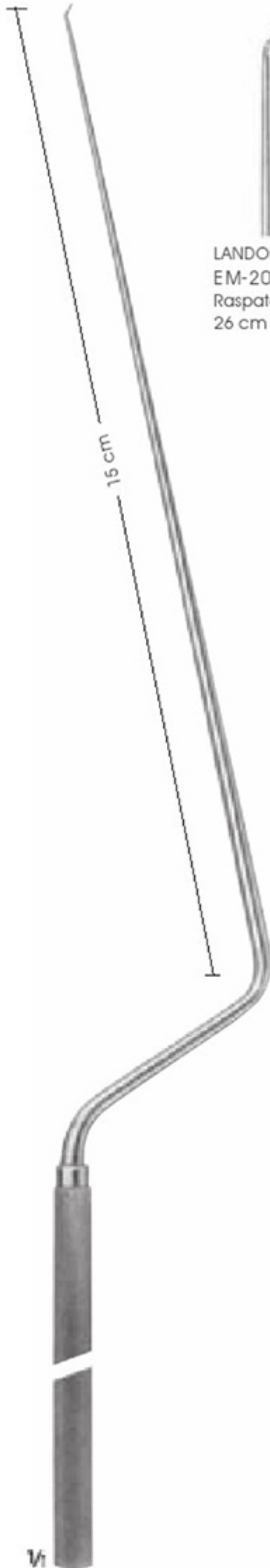
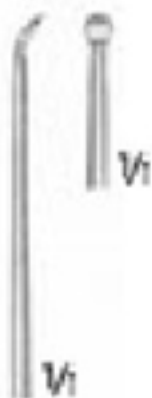

LANDOLT-REULEN
EM-20-3092-01 Ø 2.2 mm
Raspatoires, rigid
26 cm



LANDOLT-REULEN
EM-20-3092-02 Ø 3.2 mm
Raspatoires, rigid
26 cm



LANDOLT-REULEN
EM-20-3093 Ø 2.5 mm
Curette, rigid
26 cm



LANDOLT-REULEN
EM-20-3094 Ø 1.7 mm
Blunt hook
26 cm



FAHLBUSCH
EM-20-3095 Ø 2.0 mm
Spoon, malleable
26 cm



FAHLBUSCH
EM-20-3096 Ø 2.5 mm
Curette, malleable
26 cm

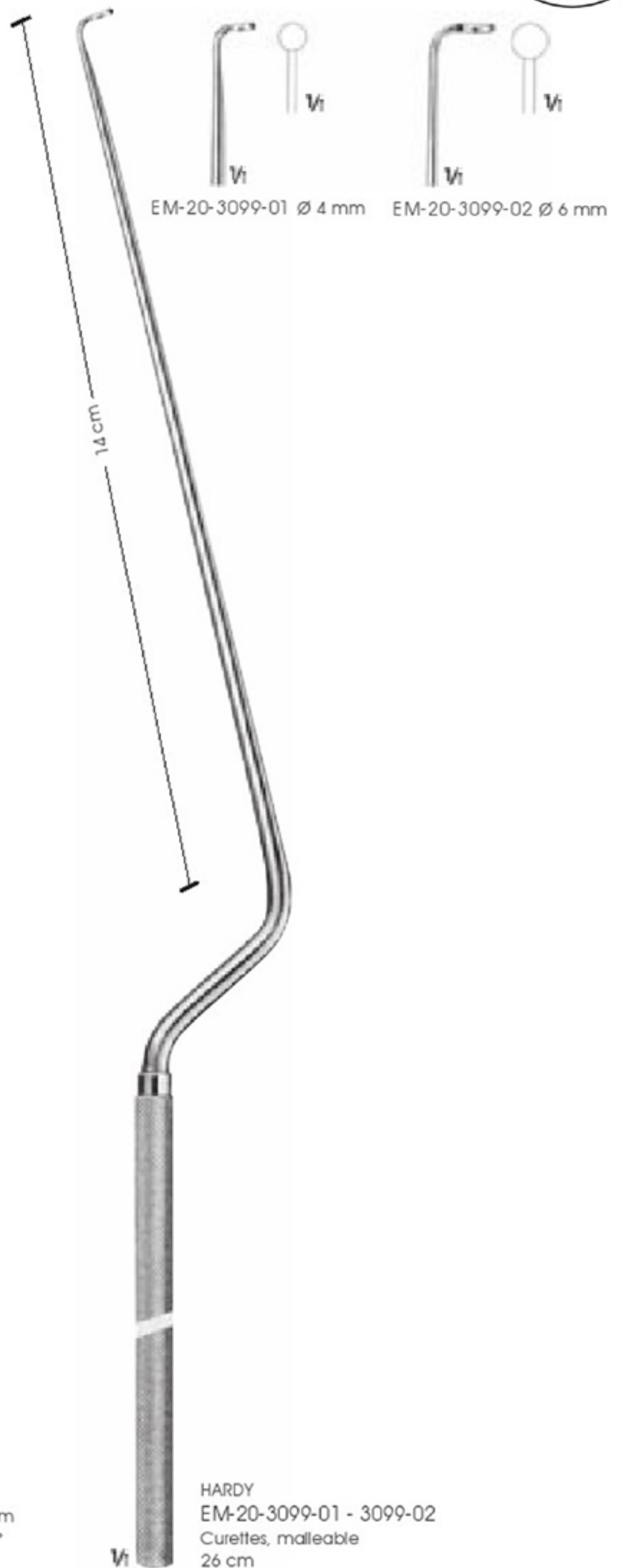

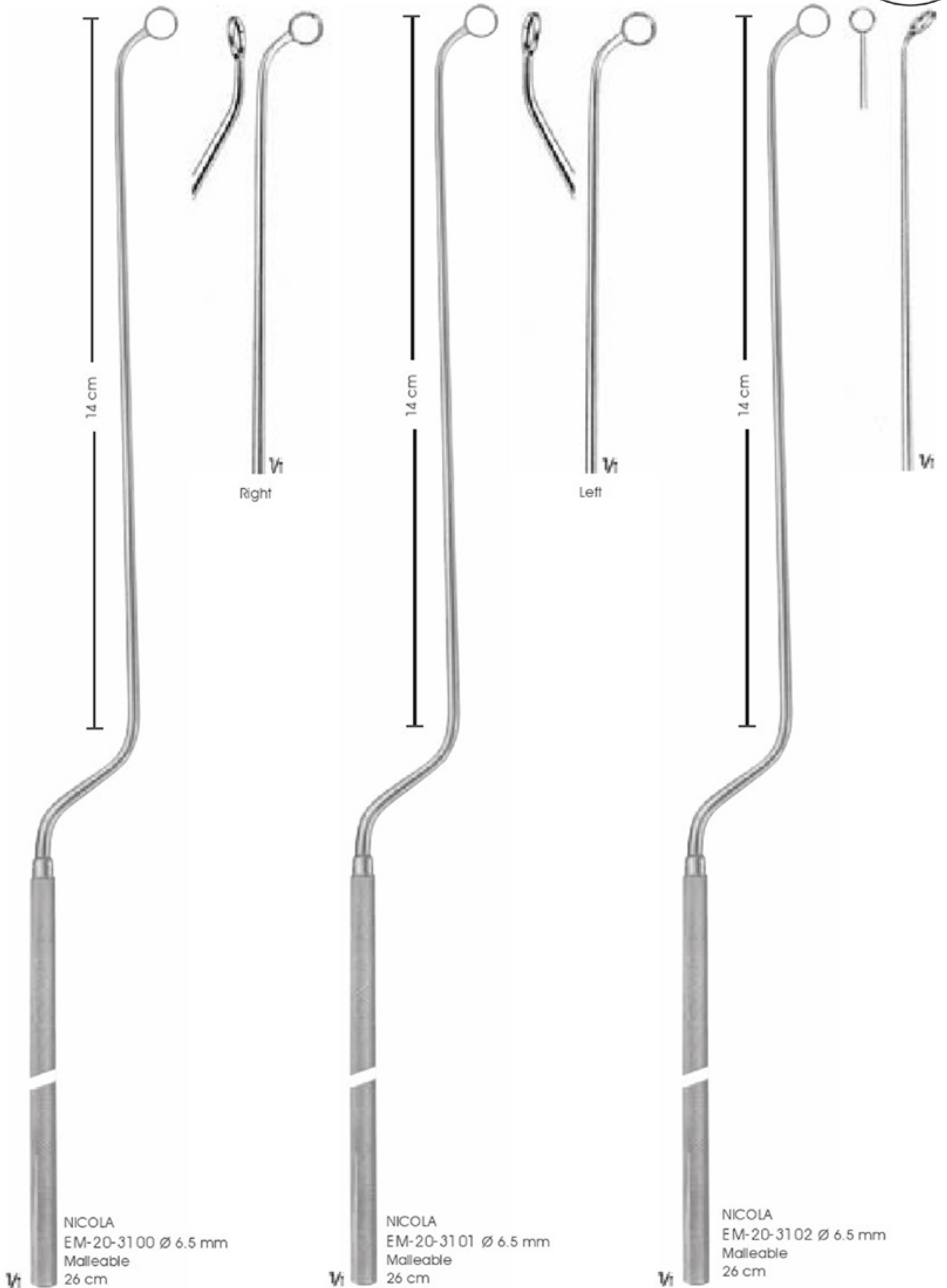

NICOLA
EM-20-3100 Ø 6.5 mm
Malleable
26 cm

NICOLA
EM-20-3101 Ø 6.5 mm
Malleable
26 cm

NICOLA
EM-20-3102 Ø 6.5 mm
Malleable
26 cm



CLOWARD
 EM-20-3103-02
 Retractor only
 25 cm



CLOWARD
 EM-20-3104-01
 Retractor only
 15 cm

CLOWARD
 EM-20-3103-01 Complete
 EM-20-3103-02
 EM-20-3103-03 - EM-20-3103-07

CLOWARD
 EM-20-3104-02 Complete
 EM-20-3104-01
 EM-20-3104-03 - EM-20-3104-07

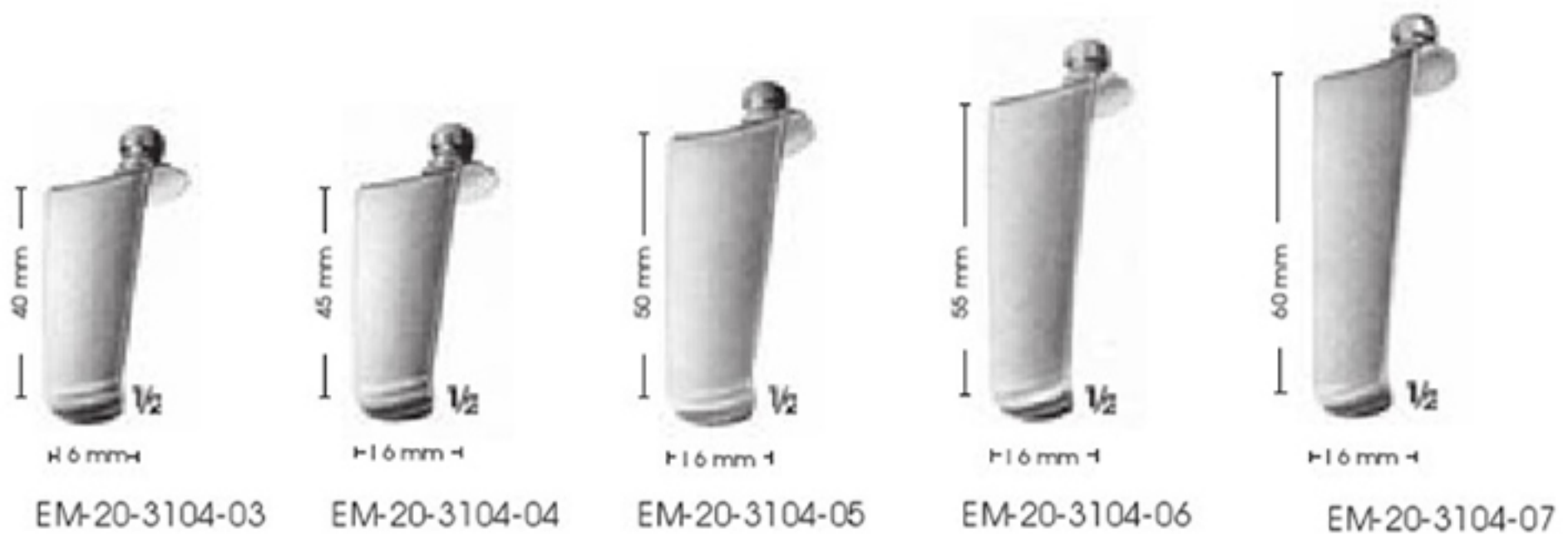
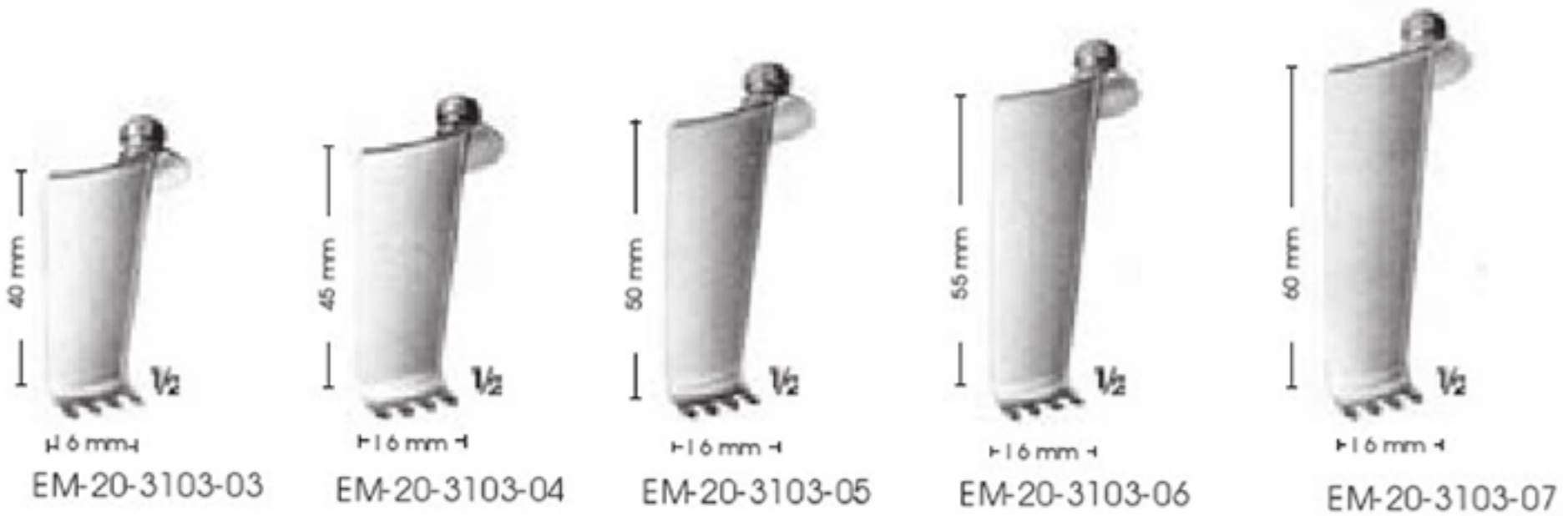



CLOWARD
EM-20-3105
15.5 cm



CLOWARD
EM-20-3106
13.5 cm

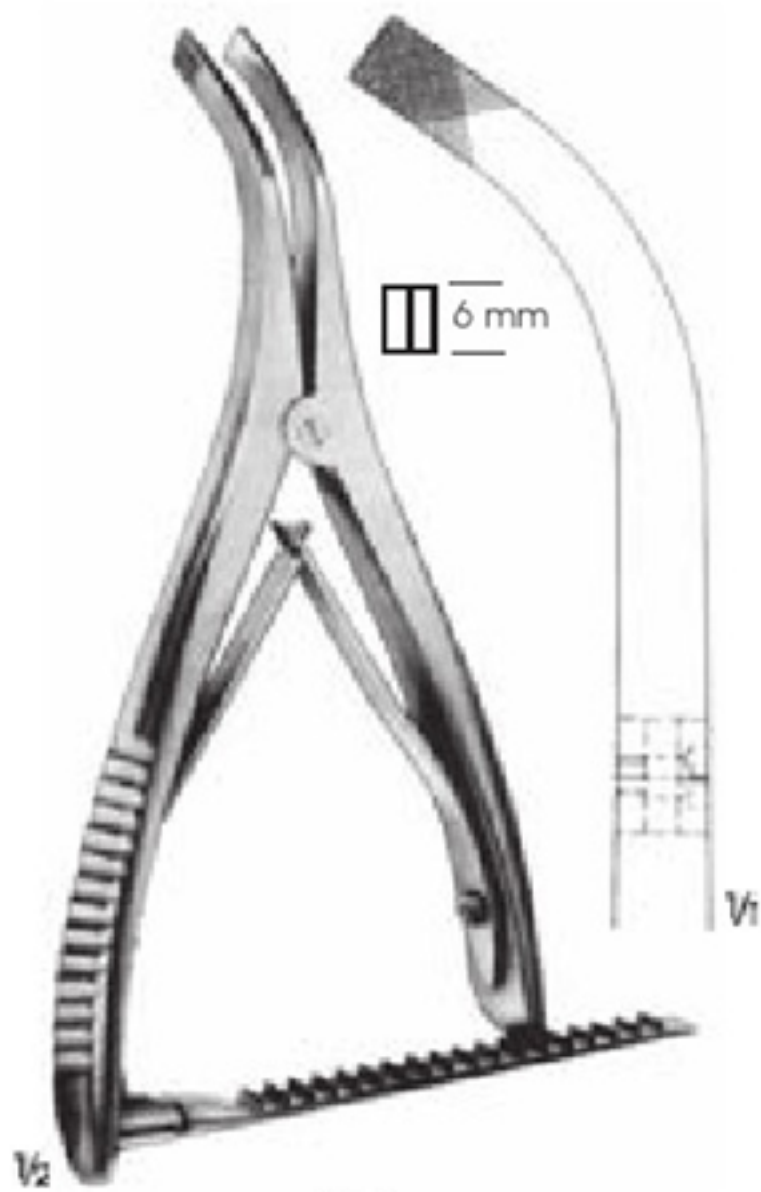

INGE
EM-20-3107
17 cm

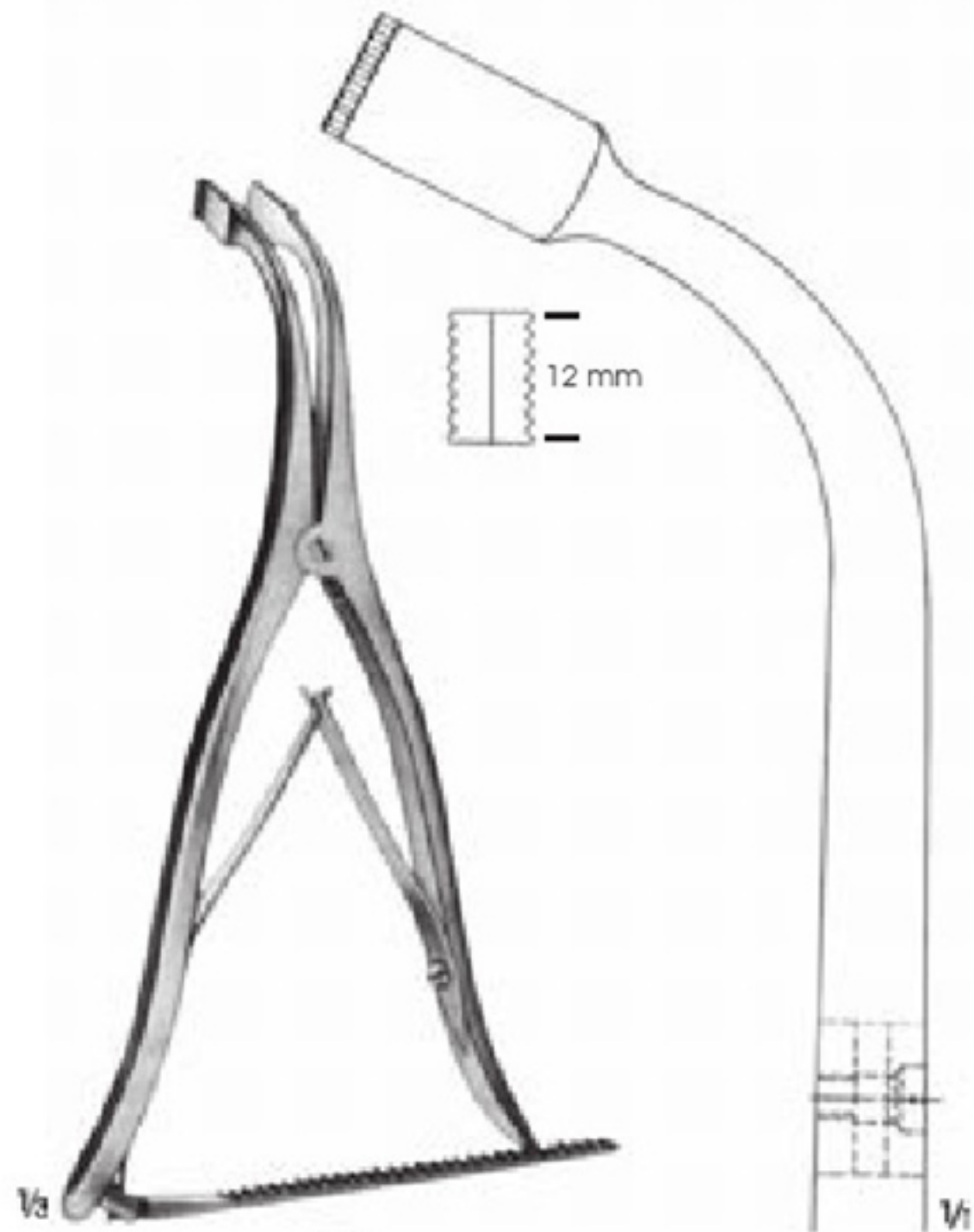

INGE
EM-20-3108
27.5 cm



CLOWARD
EM-20-3109-01 18 mm
EM-20-3109-02 20 mm
EM-20-3109-03 23 mm
18 cm



CLOWARD
EM-20-3110
Coutery hook
20 cm



CLOWARD
EM-20-3111
10 x 8 mm
19 cm



CLOWARD
EM-20-3112
20 x 12 mm
20 cm



CLOWARD
EM-20-3113 230 gr.
19 cm



CLOWARD
EM-20-3114-01 5 mm
EM-20-3114-02 8 mm
EM-20-3114-03 10 mm
EM-20-3114-04 12 mm
20 cm



4 mm
CLOWARD
EM-20-3115
18 cm



CLOWARD
EM-20-3116
20 cm



EM-20-3118-01
Ø 12 mm

EM-20-3118-02
Ø 14 mm

EM-20-3118-03
Ø 16 mm

EM-20-3118-04
Ø 18 mm

EM-20-3119-01
Ø 12 mm

EM-20-3119-02
Ø 14 mm

EM-20-3119-03
Ø 16 mm

EM-20-3119-04
Ø 18 mm

EM-20-3121-04
Ø 18 mm

EM-20-3121-03
Ø 16 mm

EM-20-3121-02
Ø 14 mm

EM-20-3121-01
Ø 12 mm

CLOWARD
EM-20-3117
Dowel cutter shaft
16.5 cm

EM-20-3118-01 - 3118-04
Dowel cutters

EM-20-3119-01 - 3119-04
Dowel center pins

EM-20-3120
Dowel ejector

EM-20-3121-01 - 3121-04
Dowel holders

EM-20-3122
Dowel handle

EM-20-3123
Wrench



EM-20-3127-01
Ø 13 mm
Small

EM-20-3127-02
Ø 16 mm
Large

EM-20-3127-01 - 3127-02
Drill shaft
14 cm

EM-20-3128-01 Ø 10 mm
EM-20-3128-02 Ø 12 mm
EM-20-3128-03 Ø 14 mm
EM-20-3128-04 Ø 16 mm

EM-20-3129 Ø 22 mm
Handle inside diameter

EM-20-3130-01 Ø 13 mm
Small
EM-20-3130-02 Ø 16 mm 3 mm
Large
Drill guard

EM-20-3131 Ø 25 mm
Drill Guard cap

EM-20-3124
Dowel handle
18 cm

EM-20-3125
Depth gauge
21 cm

EM-20-3126-01 Ø 9.5 mm
EM-20-3126-02 Ø 13 mm
Guard guide
19 cm

EM-20-3128-01 - 31128-04
Drill tip



EM-20-3132
Retractor only, with key EM-20-3133



EM-20-3133
Screwdriver
15 cm



EM-20-3134-01 20 x 35 mm
EM-20-3134-02 20 x 40 mm
EM-20-3134-03 20 x 45 mm
EM-20-3134-04 20 x 55 mm
EM-20-3134-05 20 x 65 mm
Blades titanium

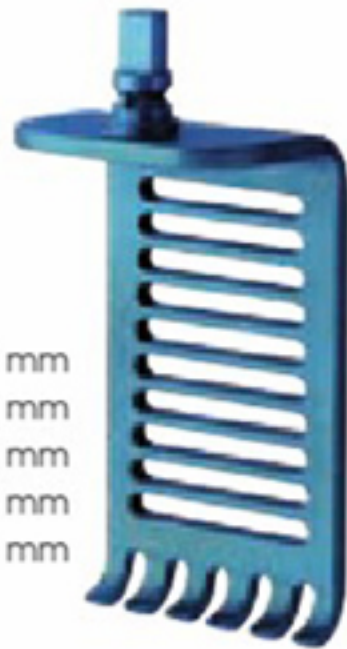

EM-20-3134-11 40 x 35 mm
EM-20-3134-12 40 x 40 mm
EM-20-3134-13 40 x 45 mm
EM-20-3134-14 40 x 55 mm
EM-20-3134-15 40 x 65 mm
EM-20-3134-16 40 x 75 mm
Blades titanium



EM-20-3134-21 60 x 35 mm
EM-20-3134-22 60 x 40 mm
EM-20-3134-23 60 x 45 mm
EM-20-3134-24 60 x 55 mm
EM-20-3134-25 60 x 65 mm
EM-20-3134-26 60 x 75 mm
EM-20-3134-27 60 x 85 mm
Blades titanium



EM-20-3135
Hemi-Laminectomy hook, small 38 mm



EM-20-3136
Hemi-Laminectomy hook, large 58 mm



EM-20-3137
Handle for positioning of the
retractor blades



EM-20-3138
Doble hinged Cervical retractor



EM-20-3139
Doble hinged retractor used for longitudinal retraction



EM-20-3140
Counter retractor



EM-20-3141-01 30 x 24 mm
EM-20-3141-02 35 x 24 mm
EM-20-3141-03 40 x 24 mm
EM-20-3141-04 45 x 24 mm
EM-20-3141-05 50 x 24 mm
EM-20-3141-06 55 x 24 mm
EM-20-3141-07 60 x 24 mm
EM-20-3141-08 65 x 24 mm
EM-20-3141-09 70 x 24 mm
Medial blades titanium



EM-20-3142-01 30 x 24 mm
EM-20-3142-02 35 x 24 mm
EM-20-3142-03 40 x 24 mm
EM-20-3142-04 45 x 24 mm
EM-20-3142-05 50 x 24 mm
EM-20-3142-06 55 x 24 mm
EM-20-3142-07 60 x 24 mm
EM-20-3142-08 65 x 24 mm
EM-20-3142-09 70 x 24 mm
Lateral blades titanium



EM-20-3143-01 35 x 24 mm
EM-20-3143-02 40 x 24 mm
EM-20-3143-03 45 x 24 mm
EM-20-3143-04 50 x 24 mm
EM-20-3143-05 55 x 24 mm
EM-20-3143-06 60 x 24 mm
EM-20-3143-07 65 x 24 mm
EM-20-3143-08 70 x 24 mm
EM-20-3143-09 75 x 24 mm
Blunt blades titanium



EM-20-3144-01 30 x 24 mm
EM-20-3144-02 35 x 24 mm
EM-20-3144-03 40 x 24 mm
EM-20-3144-04 45 x 24 mm
EM-20-3144-05 50 x 24 mm
EM-20-3144-06 55 x 24 mm
EM-20-3144-07 60 x 24 mm
EM-20-3144-08 65 x 24 mm
EM-20-3144-09 70 x 24 mm
Medial blades titanium



EM-20-3145-01 30 x 24 mm
EM-20-3145-02 35 x 24 mm
EM-20-3145-03 40 x 24 mm
EM-20-3145-04 45 x 24 mm
EM-20-3145-05 50 x 24 mm
EM-20-3145-06 55 x 24 mm
EM-20-3145-07 60 x 24 mm
EM-20-3145-08 65 x 24 mm
EM-20-3145-09 70 x 24 mm
Lateral blades titanium



EM-20-3146-01 35 x 24 mm
EM-20-3146-02 40 x 24 mm
EM-20-3146-03 45 x 24 mm
EM-20-3146-04 50 x 24 mm
EM-20-3146-05 55 x 24 mm
EM-20-3146-06 60 x 24 mm
EM-20-3146-07 65 x 24 mm
EM-20-3146-08 70 x 24 mm
EM-20-3146-09 75 x 24 mm
Blunt blades titanium



EM-20-3147-01 25 x 19 mm
EM-20-3147-02 30 x 19 mm
EM-20-3147-03 35 x 19 mm
EM-20-3147-04 40 x 19 mm
EM-20-3147-05 45 x 19 mm
EM-20-3147-06 50 x 19 mm
EM-20-3147-07 55 x 19 mm
EM-20-3147-08 60 x 19 mm
Teeth blades titanium



EM-20-3148-01 25 x 19 mm
EM-20-3148-02 30 x 19 mm
EM-20-3148-03 35 x 19 mm
EM-20-3148-04 40 x 19 mm
EM-20-3148-05 45 x 19 mm
EM-20-3148-06 50 x 19 mm
EM-20-3148-07 55 x 19 mm
EM-20-3148-08 60 x 19 mm
Blunt blades titanium



EM-20-3149
Handle for blades with side load attachment