

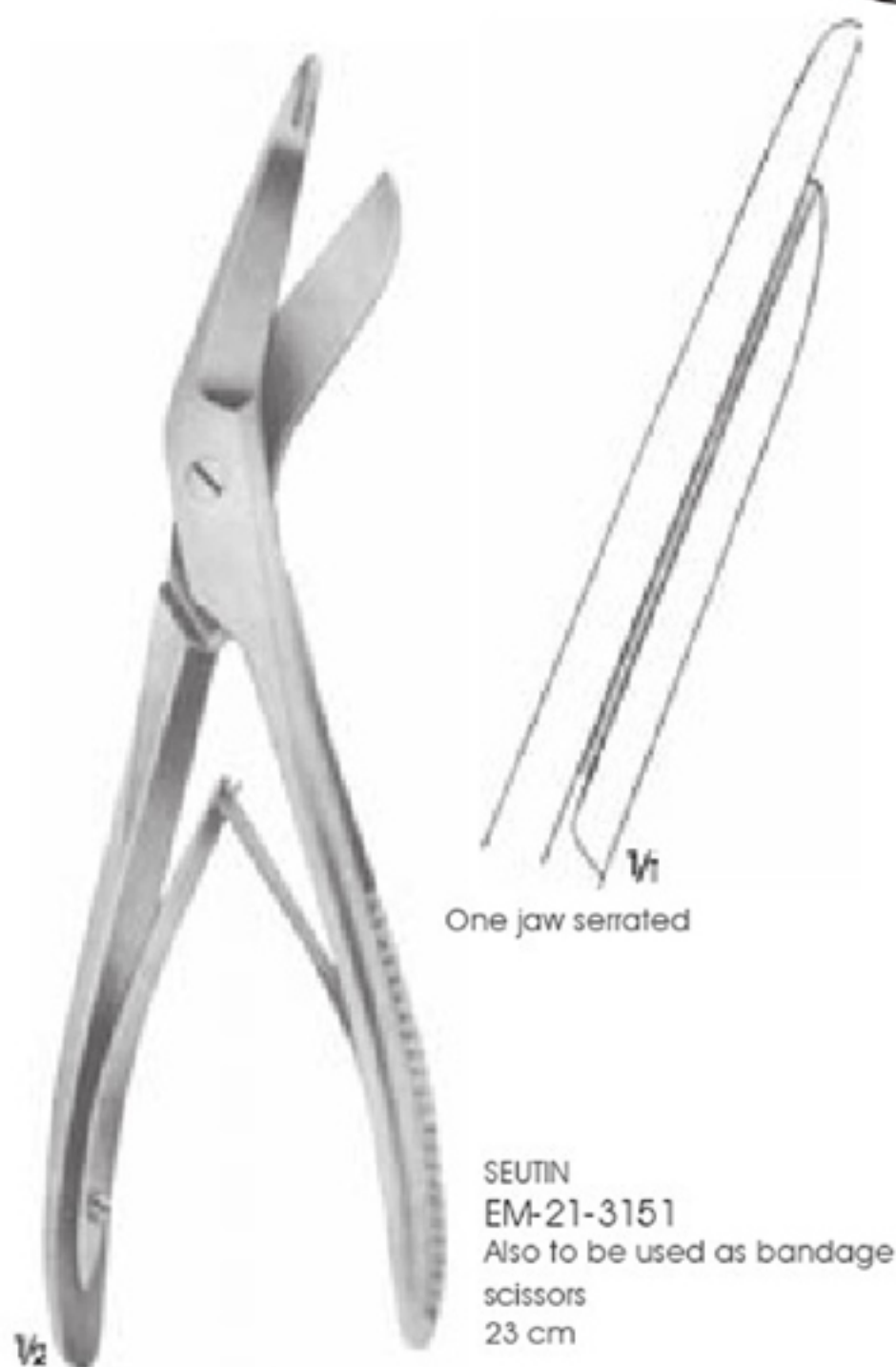

# Orthopedic Surgery

## Orthopädische Operation





ESMARCH  
EM-21-3154  
Plaster knife  
18 cm

1/2



ENGEL  
EM-21-3155  
Plaster saw  
15 cm

1/2



BRUNS  
EM-21-3156  
23.5 cm

1/2

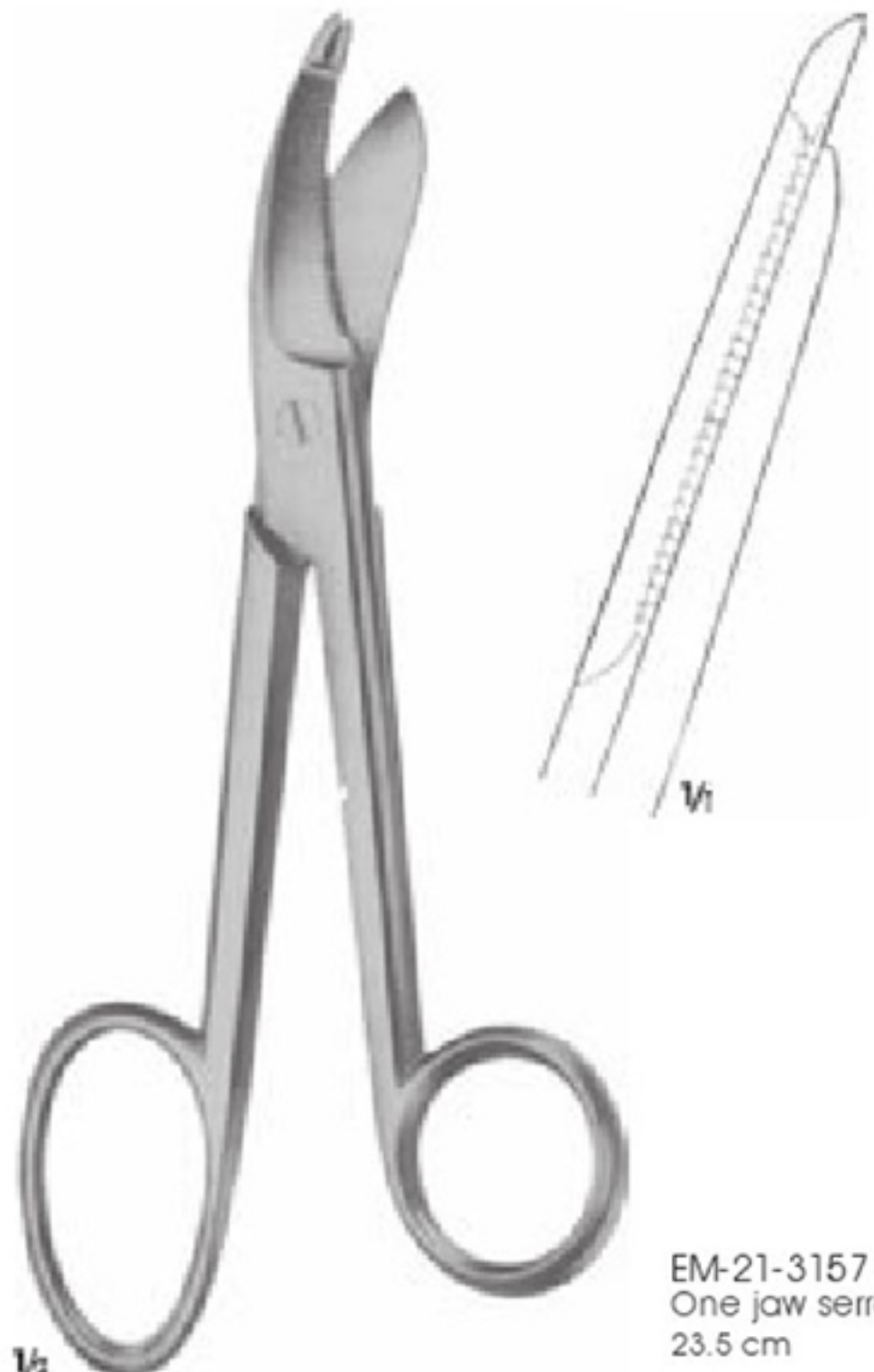

EM-21-3157  
One jaw serrated  
23.5 cm

1/2





STILLE  
EM-21-3158  
23 cm



STILLE  
EM-21-3159  
26 cm



STILLE  
EM-21-3160  
36 cm



STILLE  
EM-21-3161  
37 cm





EM-21-3162  
Plaster shear  
23 cm



HENNIG  
EM-21-3163  
Plaster shear  
27 cm



WOLFF  
EM-21-3164-01 18 cm  
EM-21-3164-02 24 cm  
Plaster breakers



EM-21-3165  
Plaster shear  
29 cm



With removable jaws

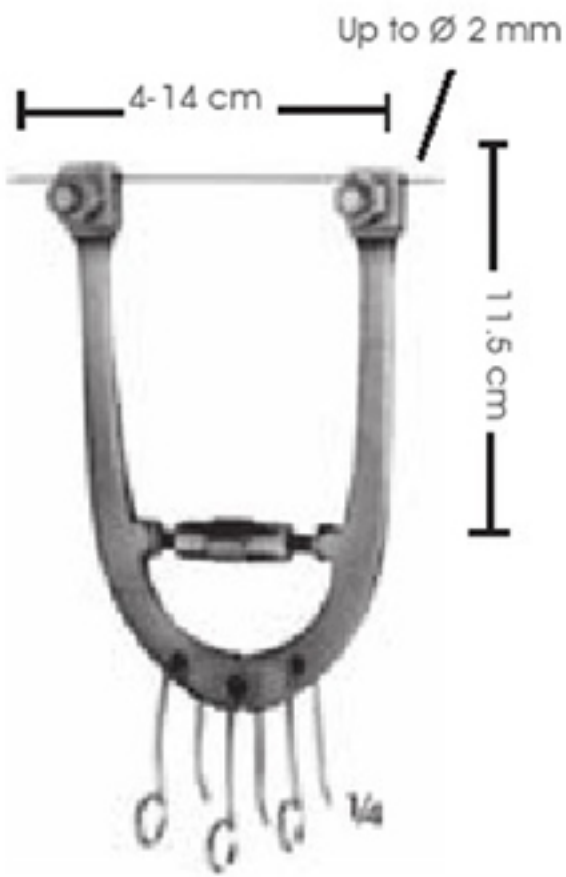

EM-21-3166-01  
Wire traction bow, adjustable, with 3 hooks,  
small size  
EM-21-3172 Suitable wrench



EM-21-3167  
Wire traction bow, adjustable, with 3 hooks,  
small size  
EM-21-3172 suitable wrench

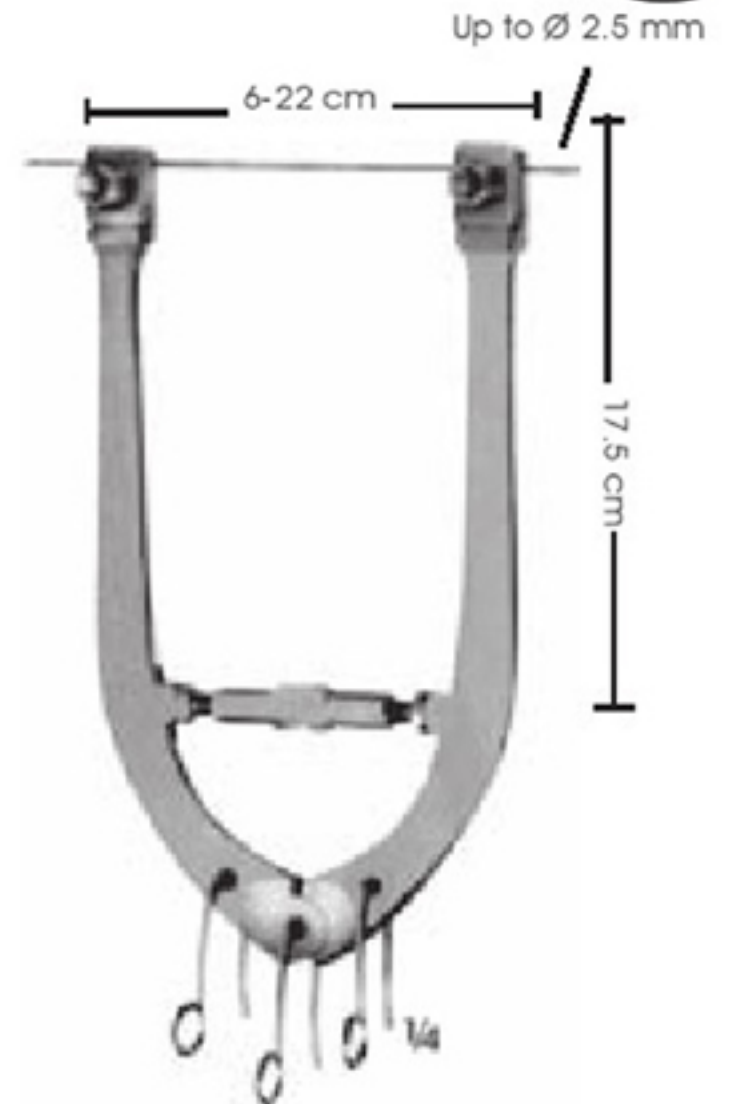

EM-21-3166-02  
Wire traction bow, adjustable, with 3 hooks,  
large size  
EM-21-3172 Suitable wrench



EM-21-3168  
Screw driver for fixation discs

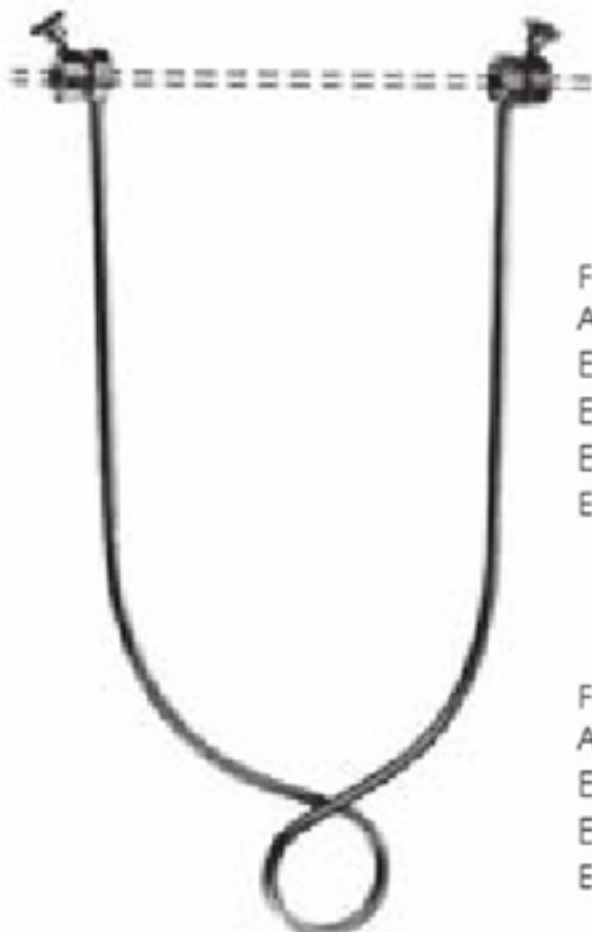

For  $\varnothing$  4 mm STEINMANN pins  
Arms dimensions  
EM-21-3169-01 16 x 9 cm  
EM-21-3169-02 21 x 11cm  
EM-21-3169-03 21 x 15 cm  
Except for STEINMANN pins

For  $\varnothing$  5 mm STEINMANN Pins  
Arms dimensions  
EM-21-3169-04 16 x 9 cm  
EM-21-3169-05 21 x 11 cm  
Except for STEINMANN pins



EM-21-3170-01 1 kg  
EM-21-3170-02 2 kg  
EM-21-3170-03 5 kg  
Weight

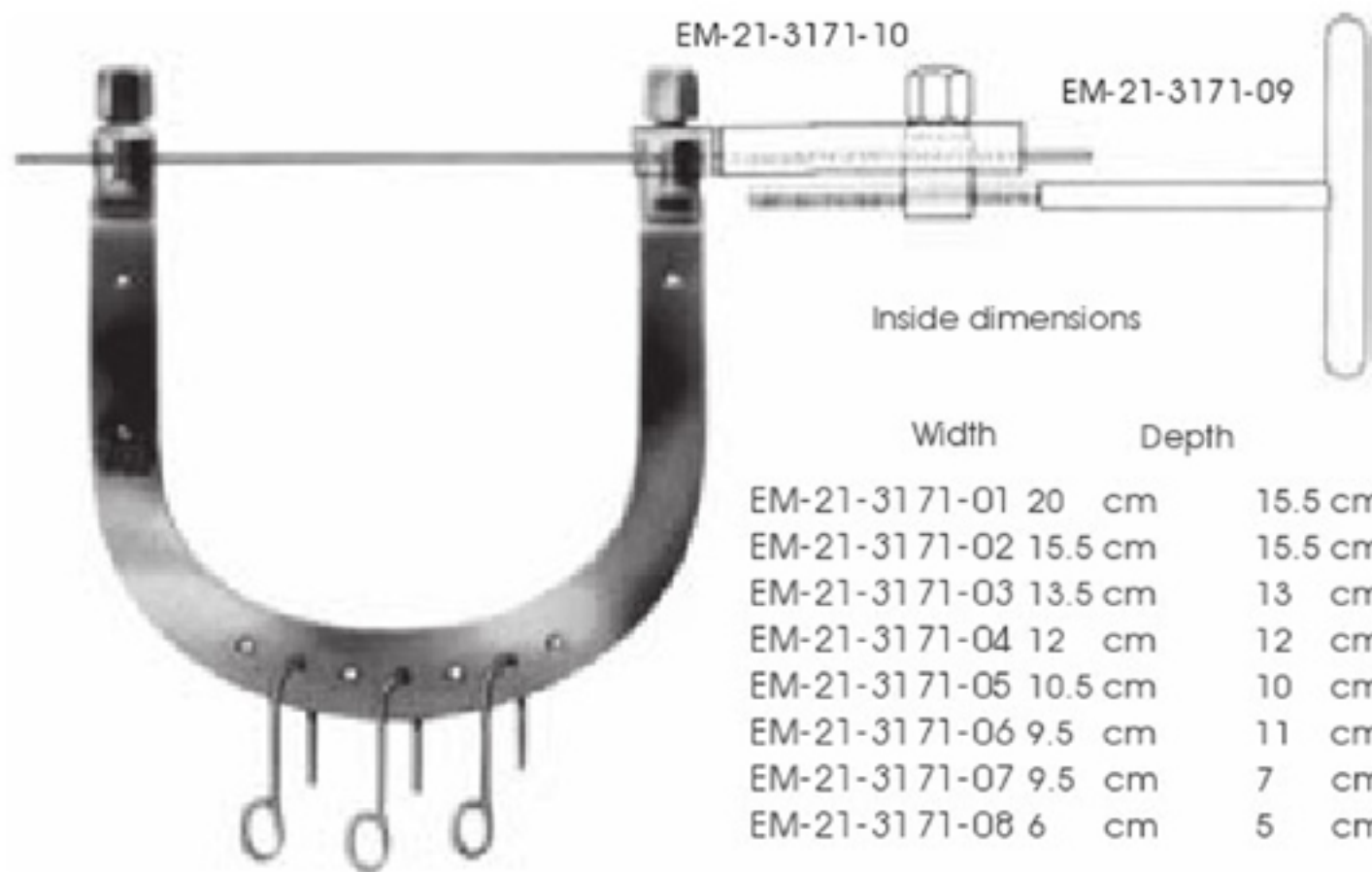

KIRSCHNER  
EM-21-3171-01 - EM-21-3171-07  
Wire traction bows, to be used with KIRSCHNER  
wires up to  $\varnothing$  2.5 mm, with 3 hooks

	Width	Depth	
EM-21-3171-01	20 cm	15.5 cm	For the hip
EM-21-3171-02	15.5 cm	15.5 cm	For the femur
EM-21-3171-03	13.5 cm	13 cm	For the knee
EM-21-3171-04	12 cm	12 cm	For the knee
EM-21-3171-05	10.5 cm	10 cm	For the knee
EM-21-3171-06	9.5 cm	11 cm	For the calcaneus
EM-21-3171-07	9.5 cm	7 cm	For the arm and elbow
EM-21-3171-08	6 cm	5 cm	For the elbow child size



EM-21-3171-10  
For fixation clamp



EM-21-3172  
Wrench, double-ended, for wire  
traction bows EM-21-3171 - EM-21-3167



EM-21-3173-01  
Large size traction hook



EM-21-3173-02  
Small size traction hook



EM-21-3174-01  
Fixation disc, slotted



EM-21-3174-02  
Fixation disc, slotted idem,  
aluminium transparent to  
X-rays



EM-21-3174-03  
Fixation disc, slotted



EM-21-3175  
Small distractor  
For wires  $\varnothing$  3.0 mm





EM-21-3176-01  
27.5 cm



EM-21-3176-02  
28.5 cm



EM-21-3176-03  
30.5 cm

DEMEL  
EM-21-3176-01 - 3176-03  
Wire guides



EM-21-3177-01 - 3177-02



EM-21-3177-01  
24 cm



EM-21-3177-02  
27 cm



EM-21-3178  
22.5 cm



EM-21-3179-01 Ø 0.2 mm  
EM-21-3179-02 Ø 0.3 mm  
EM-21-3179-03 Ø 0.4 mm

EM-21-3179-04 Ø 0.5 mm  
EM-21-3179-05 Ø 0.6 mm  
EM-21-3179-06 Ø 0.7 mm

EM-21-3179-07 Ø 0.8 mm  
EM-21-3179-08 Ø 0.9 mm  
EM-21-3179-09 Ø 1.0 mm

EM-21-3179-10 Ø 1.2 mm  
EM-21-3179-11 Ø 1.5 mm

EM-21-3179-01 - 3179-11

Wire, soft, tissue compatible, in coils of 10 m

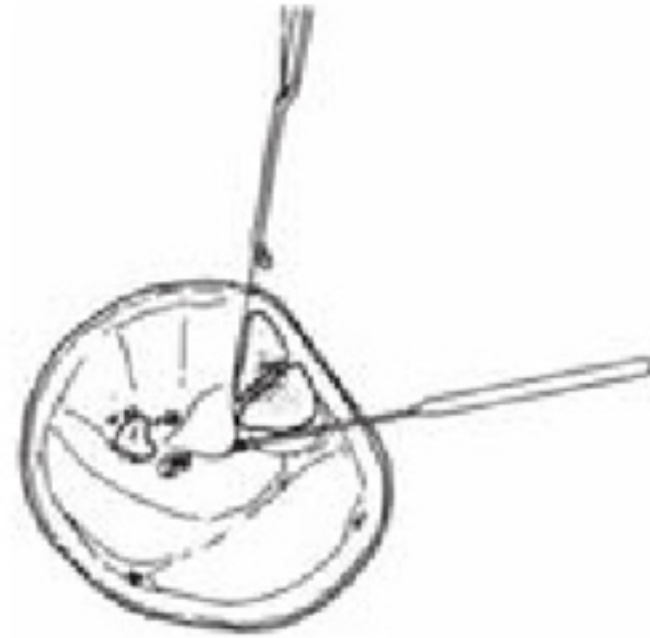

Movable tip made of material used for implants. While twisting the movable head remains stable, therefore the wire will not slip off.

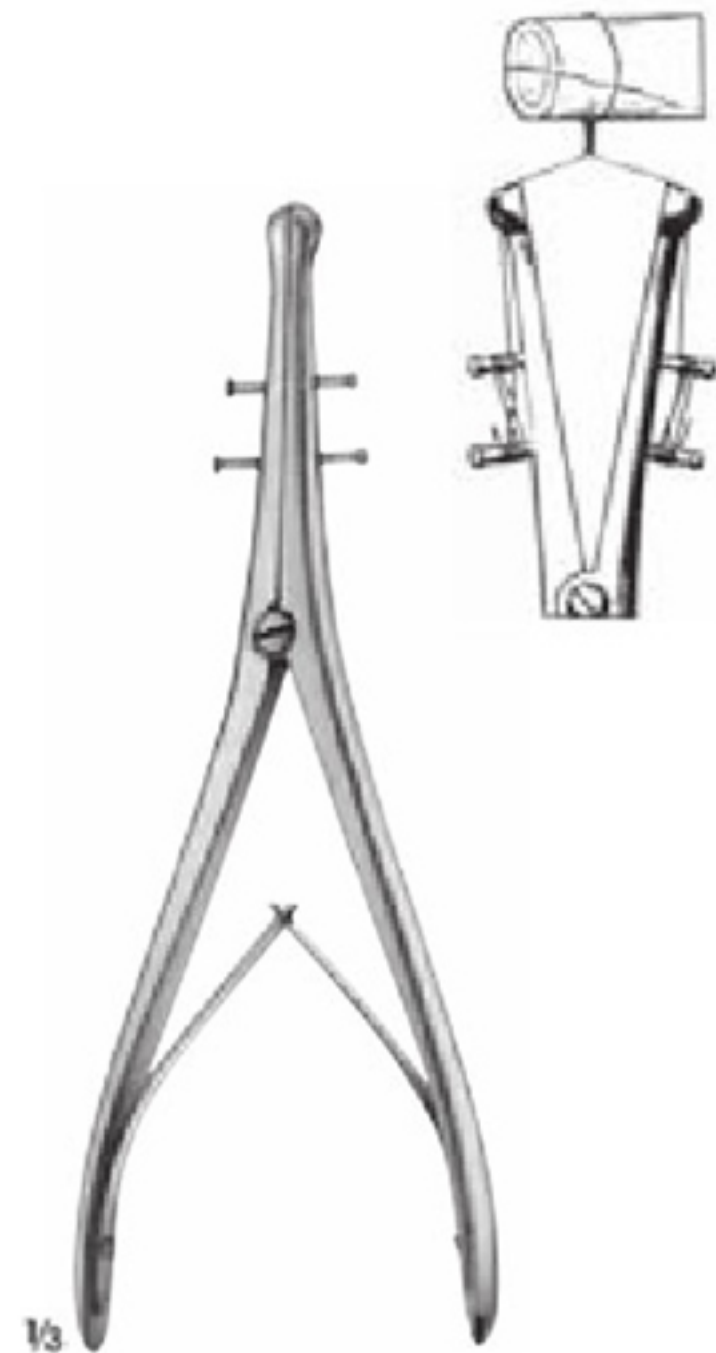

LOUTE  
EM-21-3180

Wire tightener, improved pattern, with movable tip, for wires up to 1.0 mm diam  
22 cm

DEMEL  
EM-21-3181

Wire tightening- and twisting forceps  
27 cm

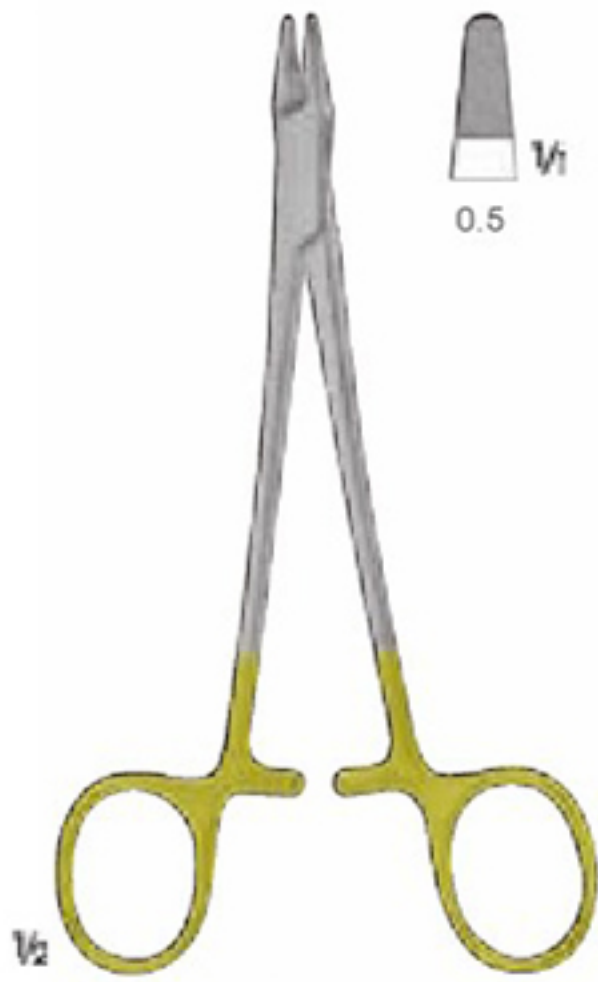

EM-21-3182  
Wire twister  
Ligature forceps  
15 cm



EM-21-3183  
Wire twister  
Ligature forceps  
15 cm

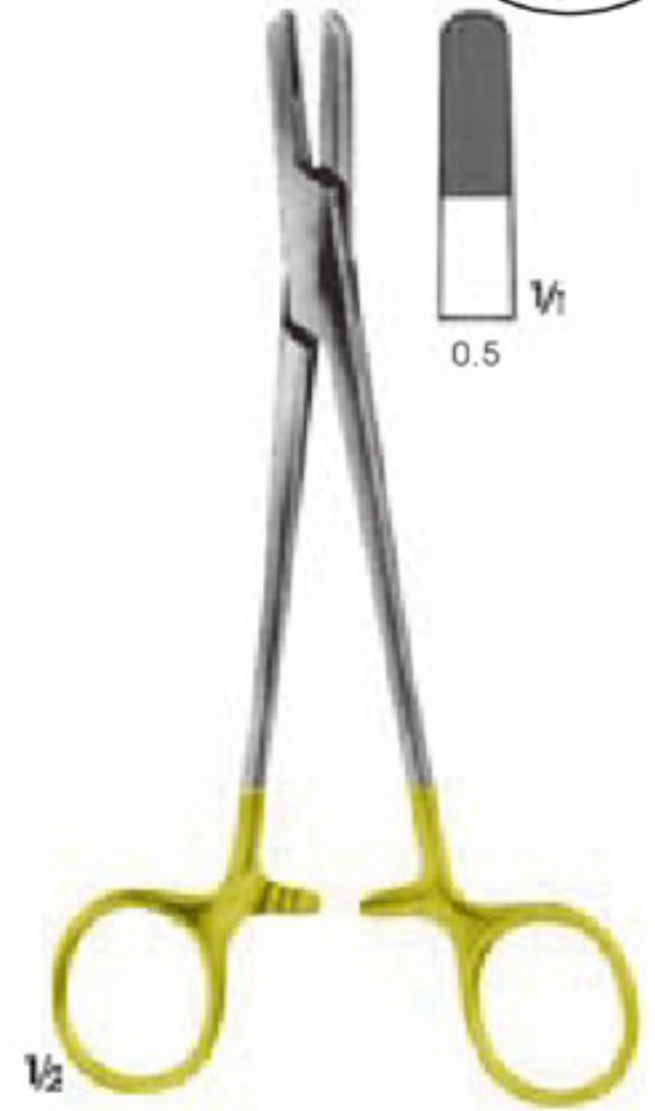

EM-21-3184  
For sternum suture  
17.5 cm



BERRY  
EM-21-3185  
Wire twister  
Ligature forceps  
18.5 cm



BAUMGARTNER  
EM-21-3186  
Wire twister  
Ligature forceps  
20 cm



EM-21-3187  
17 cm

Holding forceps for cerclage wire,  
with lateral jaws to avoid  
wire slipping off



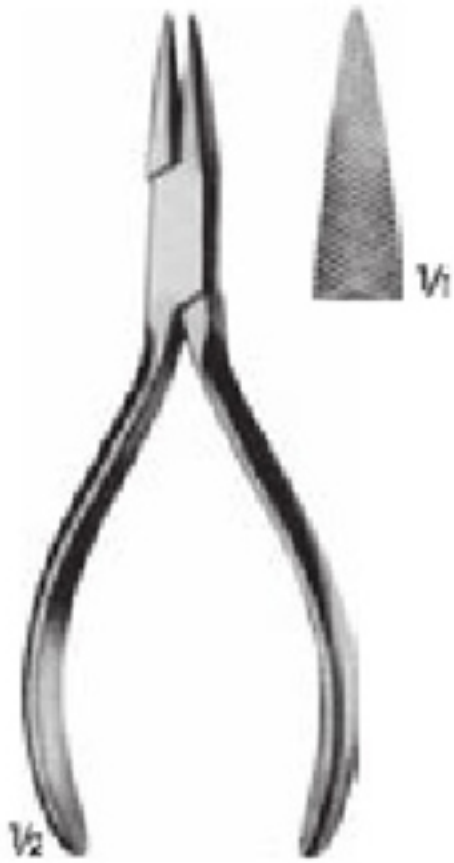

MARBURG MODELL  
EM-21-3188  
Wire holding forceps,  
Flat nosed, with serrated jaws  
14 cm

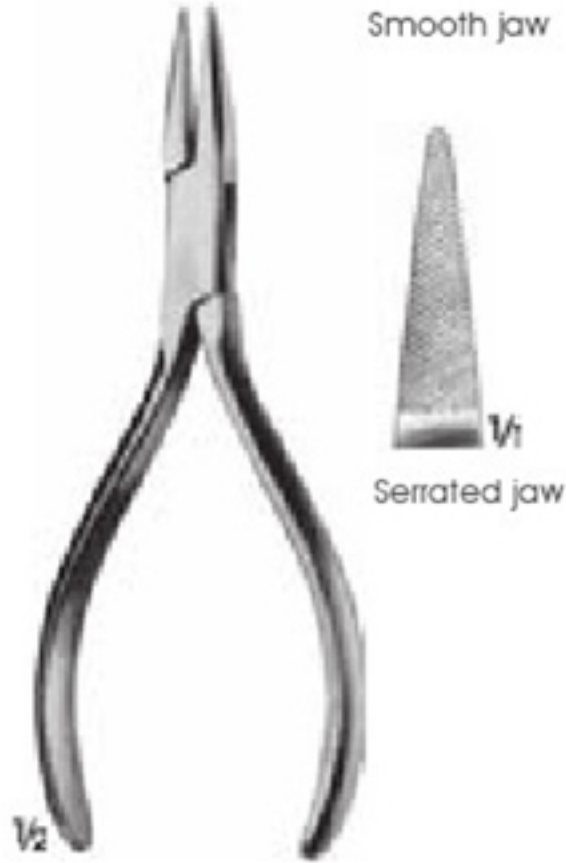

GOSLEE  
EM-21-3189  
Wire twister, flat nosed  
14 cm



EM-21-3190 - 3191  
Wire twister, flat nosed  
17 cm



EM-21-3190  
With serrated jaws



EM-21-3191  
With longitudinal  
and transversal  
grooves



EM-21-3192  
19.5 cm



EM-21-3193  
Wire holding forceps, flat nosed  
19 cm



EM-21-3194 - 3195  
Extraction pliers for boring  
wires



EM-21-3194  
13 cm



EM-21-3195  
18 cm

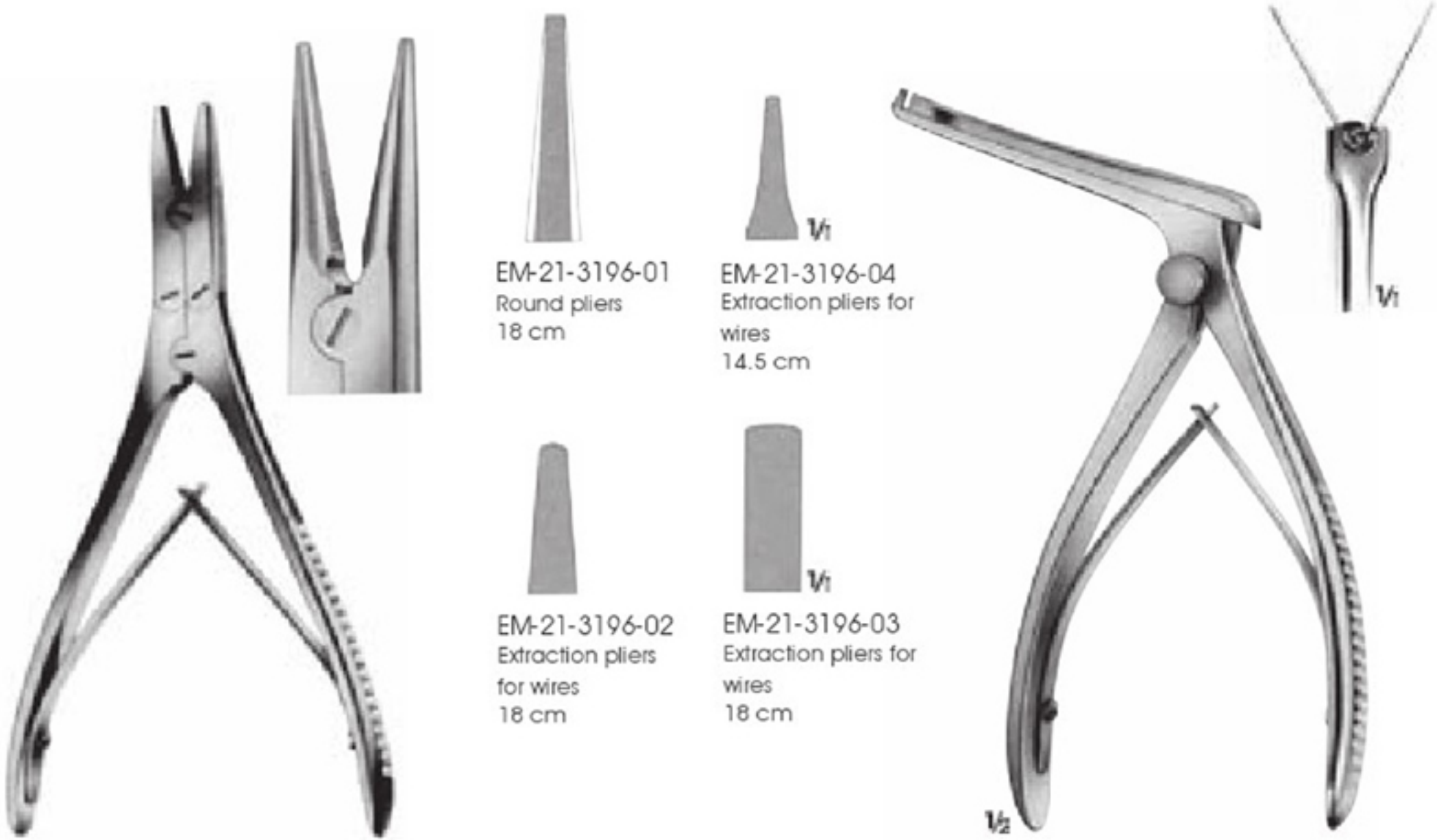

EM-21-3196-01 - 3196-04

EM-21-3196-01  
 Round pliers  
 18 cm

EM-21-3196-04  
 Extraction pliers for  
 wires  
 14.5 cm

EM-21-3196-02  
 Extraction pliers  
 for wires  
 18 cm

EM-21-3196-03  
 Extraction pliers for  
 wires  
 18 cm

EM-21-3197  
 Bending pliers for wires up to  
 1.8 mm diam.

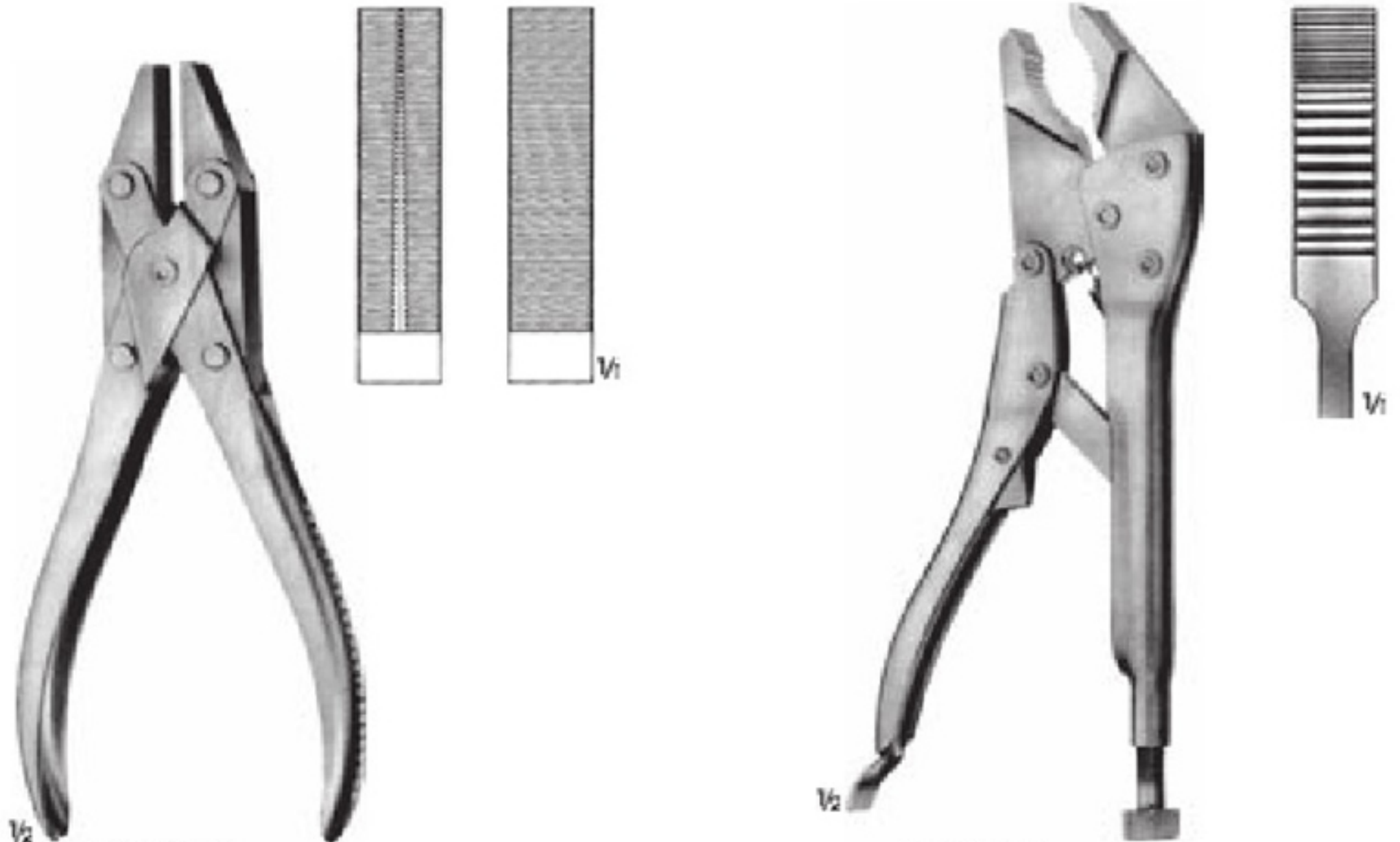

EM-21-3198  
 Flat-nosed pliers, parallel  
 18.5 cm

EM-21-3199  
 Vise grip pliers set  
 20 cm





Specially hardened cutting edges



Specially hardened cutting edges



$\nabla_1$   
For soft wire  
For hard wire

$\varnothing$  0.5 mm  
 $\varnothing$  0.3 mm

ANGLE  
EM-21-3200-01  
13 cm



$\nabla_1$   
For soft wire  
For hard wire

$\varnothing$  0.6 mm  
 $\varnothing$  0.4 mm

EM-21-3200-02  
13 cm



$\nabla_1$   
For soft wire  
For hard wire

$\varnothing$  1.5 mm  
 $\varnothing$  1.0 mm

EM-21-3201  
Tel kesme pensi  
Wire cutting pliers  
14 cm



Tungsten carbide cutting edges

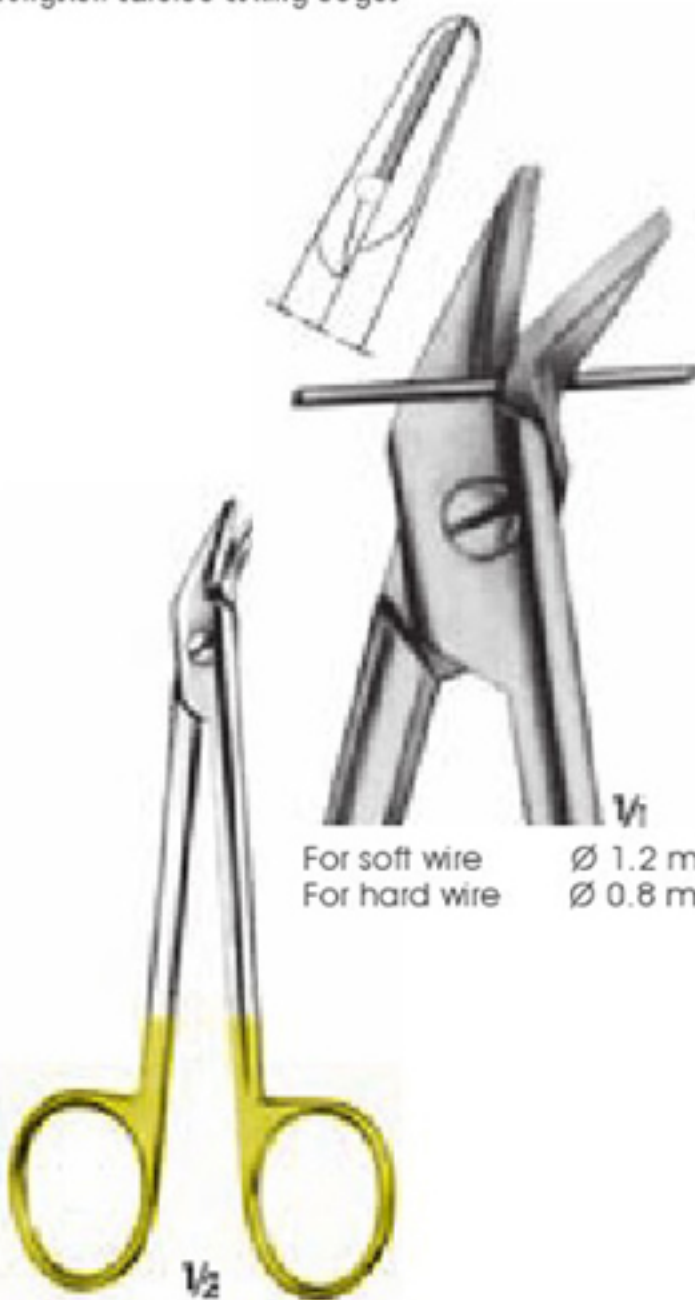

$\nabla_1$   
For soft wire  $\varnothing$  1.2 mm  
For hard wire  $\varnothing$  0.8 mm

EM-21-3202  
One jaw serrated  
12 cm

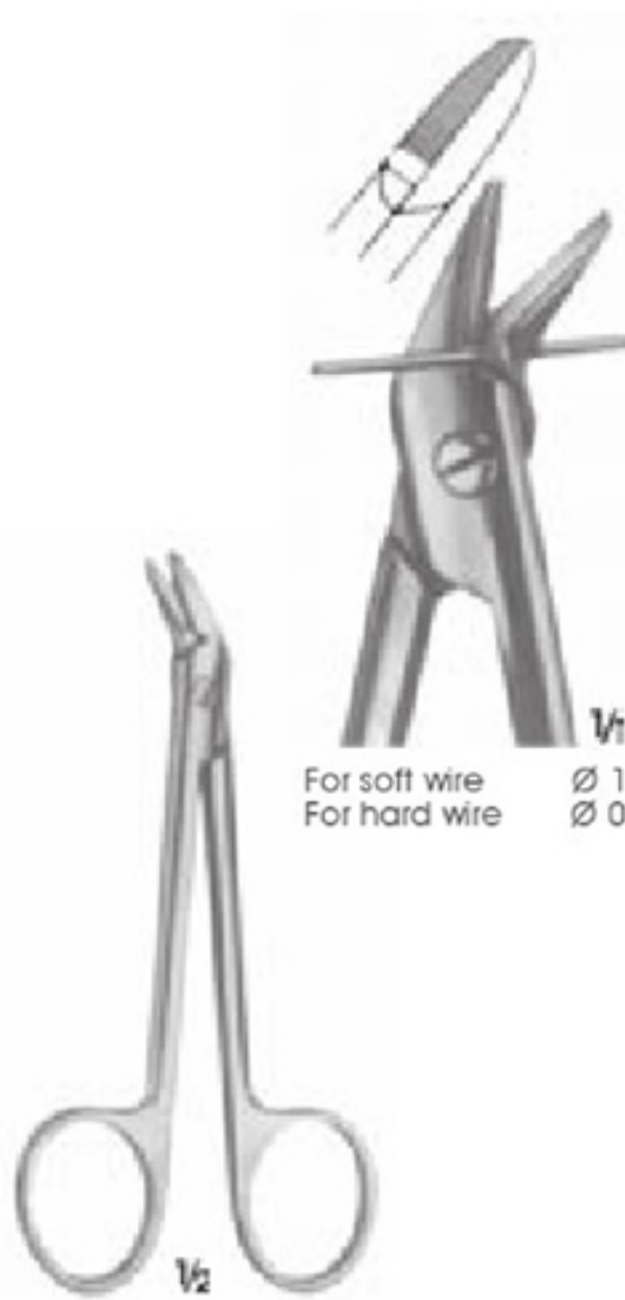

$\nabla_1$   
For soft wire  $\varnothing$  1.2 mm  
For hard wire  $\varnothing$  0.6 mm

EM-21-3203  
One jaw serrated  
12 cm

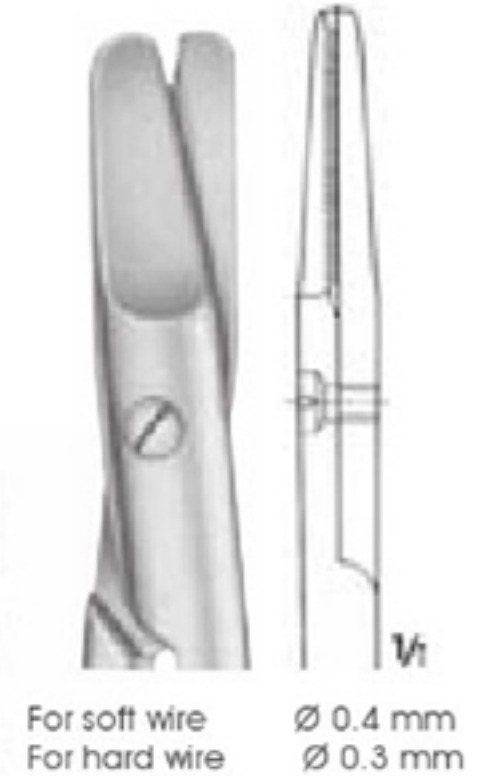
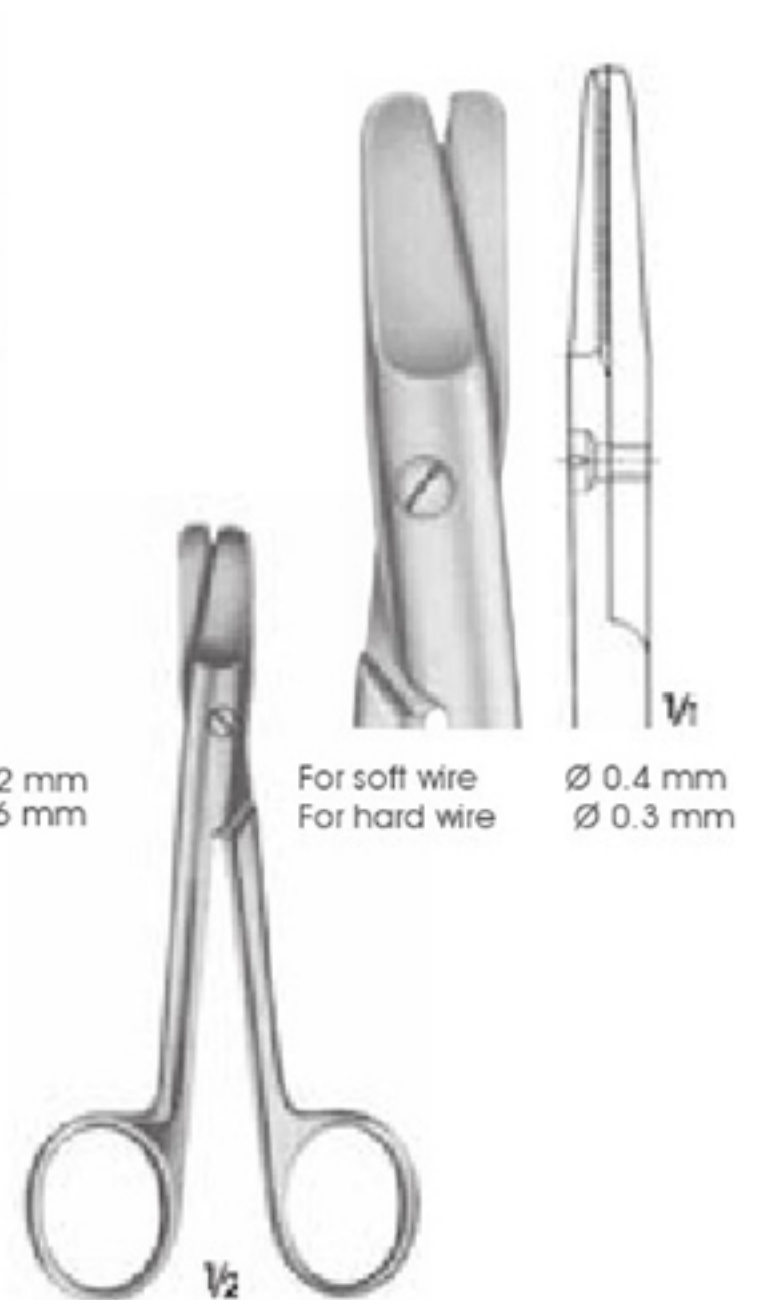

$\nabla_1$   
For soft wire  $\varnothing$  0.4 mm  
For hard wire  $\varnothing$  0.3 mm

HARVEY  
EM-21-3204  
Both jaws serrated  
12.5 cm





Specially hardened cutting edges



For soft wire  
For hard wire

Ø 1.5 mm  
Ø 1.2 mm

EM-21-3205  
16 cm

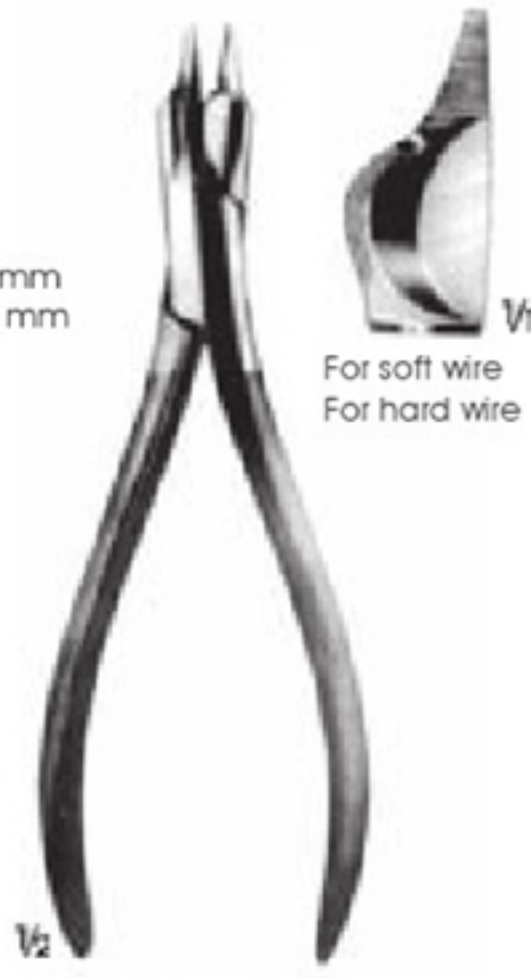

For soft wire  
For hard wire

Ø 1.5 mm  
Ø 1.0 mm

EM-21-3206  
15 cm

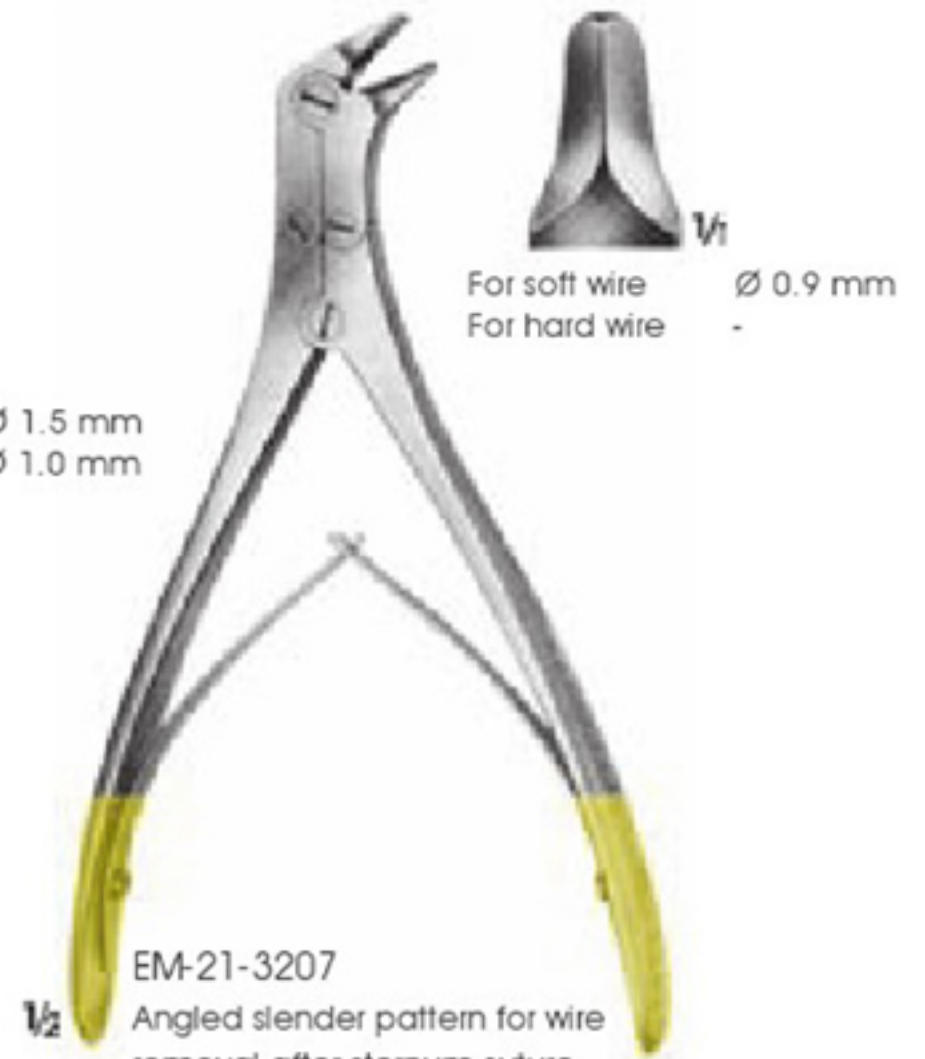

For soft wire  
For hard wire

Ø 0.9 mm  
-

EM-21-3207  
Angled slender pattern for wire  
removal after sternum suture  
17 cm



Specially hardened cutting edges



For soft wire Ø 3.0 mm  
For hard wire Ø 2.2 mm

HARVEY  
EM-21-3208  
Wire cutting pliers  
23 cm

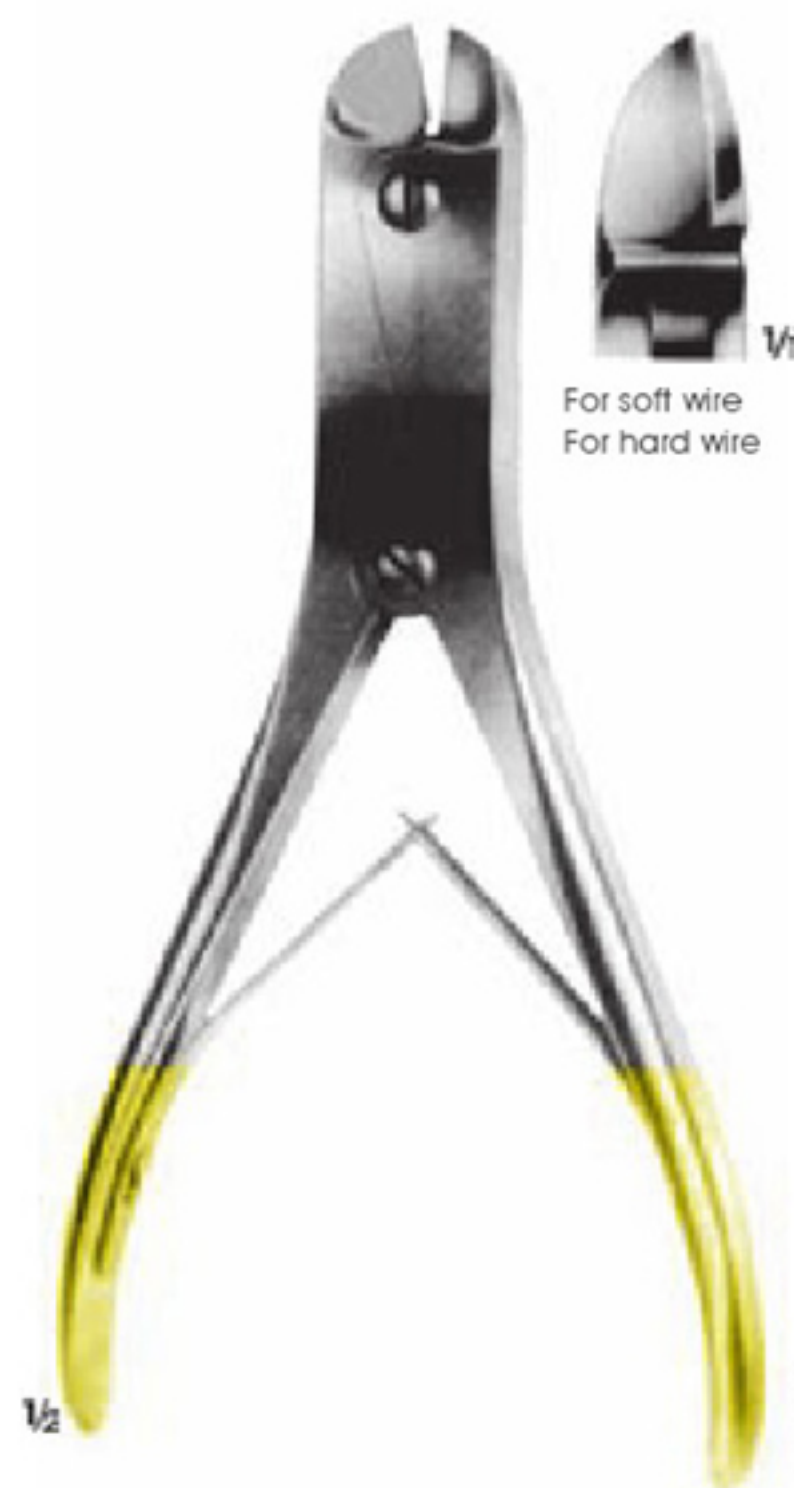

For soft wire  
For hard wire

Ø 3.0 mm  
Ø 2.2 mm

EM-21-3209  
Lateral cutting  
23.5 cm



Specially hardened cutting edges



For soft wire  $\varnothing$  2.0 mm  
For hard wire  $\varnothing$  1.5 mm

REILL  
EM-21-3210  
For cutting off wires close  
to the bone  
17.5 cm



For soft wire  $\varnothing$  2.0 mm  
For hard wire  $\varnothing$  1.5 mm

EM-21-3211  
Wire cutters, front-and lateral  
cutting action  
18 cm



Specially hardened cutting edges



For soft wire  $\varnothing$  3.0 mm  
For hard wire  $\varnothing$  2.2 mm

HARVEY  
EM-21-3212  
Wire cutting pliers  
23.5 cm



Tungsten carbide cutting edges



For soft wire  $\varnothing$  2.5 mm  
For hard wire  $\varnothing$  2.0 mm

EM-21-3213  
Wire cutting pliers  
24 cm



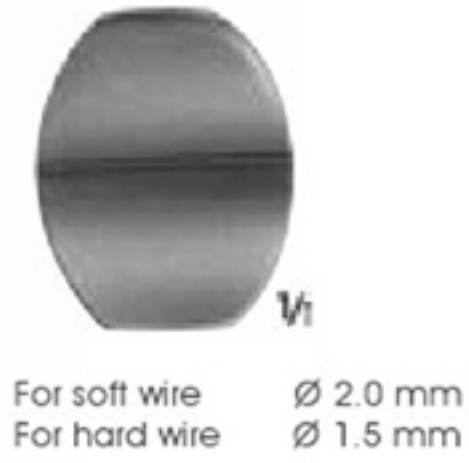

EM-21-3214  
14.5 cm

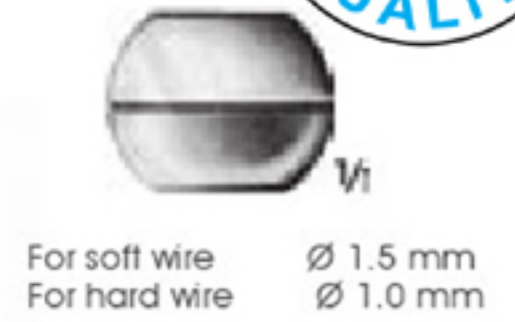

EM-21-3215  
14.5 cm



EM-21-3216  
16.5 cm

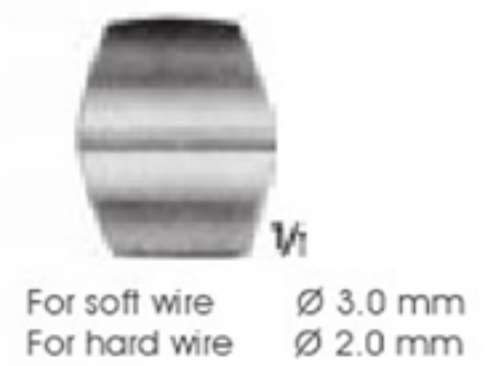

EM-21-3217  
22 cm





EM-21-3218  
For cutting off wires, screws, pins, etc. up to  $\varnothing$  3 mm  
32 cm



EM-21-3219  
For cutting off wires, screws, pins, etc. up to  $\varnothing$  6 mm  
47 cm

Can be sterilized in a steam sterilizer up to 143°





EM-21-3225  
Reamer (Aw)  
18 cm



EM-21-3226  
Reamer (Aw)  
21.5 cm



CHAMPIONNIERE  
EM-21-3227  
Bone drill  
17 cm



EM-21-3228  
Reamer (Aw)  
15 cm





$\frac{1}{2}$   
 EM-21-3229  
 Drilling chuck  
 Ø 0.8-2 mm  
 15 cm



$\frac{1}{2}$   
 EM-21-3230  
 Drilling chuck Ø 4.5 mm  
 With key V 606.02  
 14 cm



$\frac{1}{2}$   
 EM-21-3231  
 Drilling chuck Ø 6.35 mm  
 With key EM-21-3233-02  
 16 cm



EM-21-3233-02  
 Key



EM-21-3233-01  
 Key



EM-21-3232  
 With key EM-21-3233-01

inside Ø 6.7 mm  
 Outside Ø 8.7 mm



$\frac{1}{2}$



R.N.O.H.  
 EM-21-3234  
 Bone biopsy trephine  
 19.5 cm



$\frac{1}{2}$



$\frac{1}{2}$   
 EM-21-3235-01  
 Inside Ø 3.9 mm  
 Outside Ø 5 mm



$\frac{1}{2}$   
 EM-21-3235-02  
 Inside Ø 6.4 mm  
 Outside Ø 8 mm



EM-21-3233-03  
Key

BUNNEL  
EM-21-3236  
Small hand drill, canulated for KIRSCHNER wires, with 3-jaw chuck,  
to fit any size of shanks up to 4.0 mm diameter.  
With key EM-21-3233-03  
16 cm

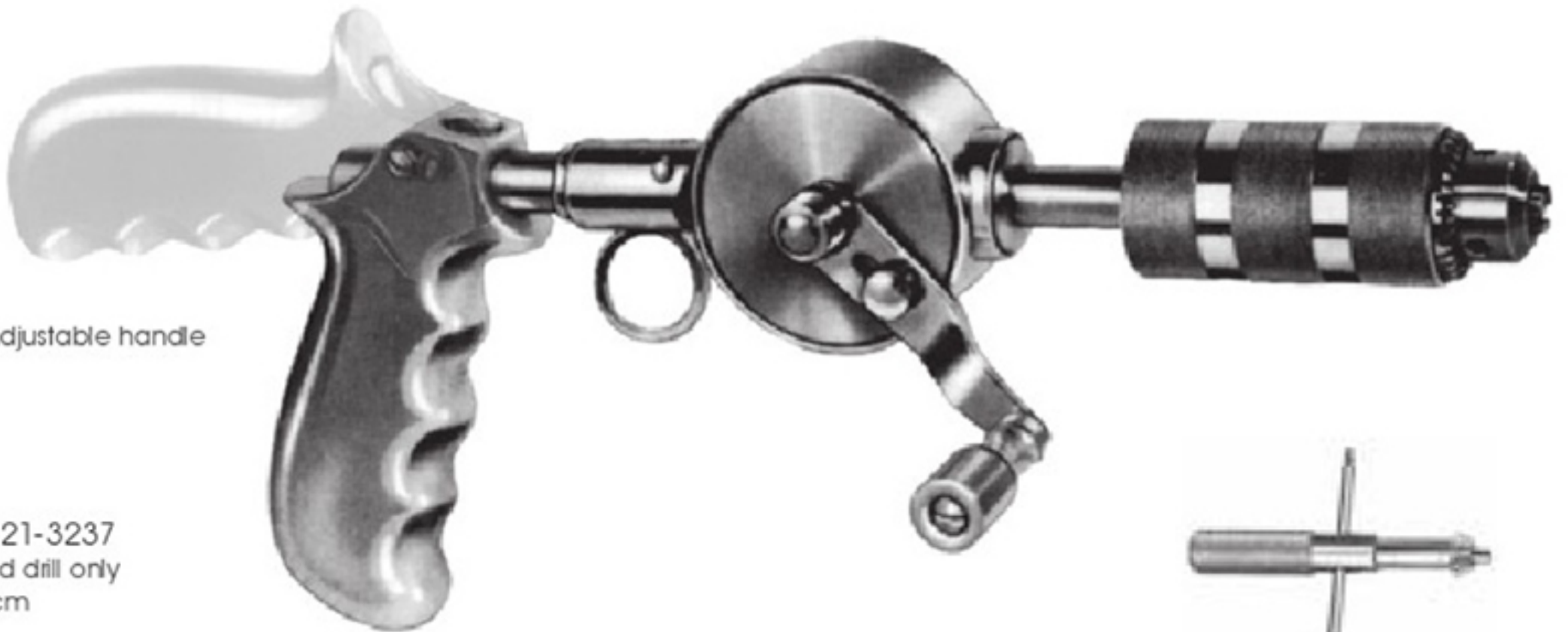

Adjustable handle

EM-21-3237  
Hand drill only  
28 cm



EM-21-3233-02  
Key

ile, anahtarlı veya anahtarsız kullanılabilir.  
Hand drill, stainless, original 'Jacops Chuck' and key EM-21-3233-02  
Can be used with or without the key.



EM-21-3241-01 20 cm  
EM-21-3241-02 25 cm  
EM-21-3240-01  
EM-21-3240-02  
EM-21-3239-02  
EM-21-3239-04  
EM-21-3239-01  
EM-21-3239-03  
EM-21-3238-02  
EM-21-3238-04  
EM-21-3238-01  
EM-21-3238-03  
3.5 mm  
2.5 mm



EM-21-3242-01  
Ø 2.7 mm  
15 cm  
EM-21-3242-02  
Ø 3.5 mm  
17 cm  
EM-21-3242-03  
Ø 4.0 mm  
20 cm  
EM-21-3242-04  
Ø 4.5 mm  
22 cm

EM-21-3242-01 - 3242-04  
Kemik tapları/Bone taps



Measuring  
6 - 40 mm  
For screws  
Ø 2.7 mm  
Ø 3.5 mm  
Ø 4.0 mm

EM-21-3243  
15.5 cm



Measuring  
10 - 60 mm  
For screws  
Ø 4.5 mm  
Ø 6.5 mm

EM-21-3244  
22 cm



EM-21-3245  
Plate holding forceps  
20 cm





With Carbide Cutting Edges



For soft wire  
 For hard wire

∅ 2.0 mm  
 ∅ 1.5 mm

REILL  
 EM-21-3246  
 For cutting off wires close to the bone  
 17.5 cm

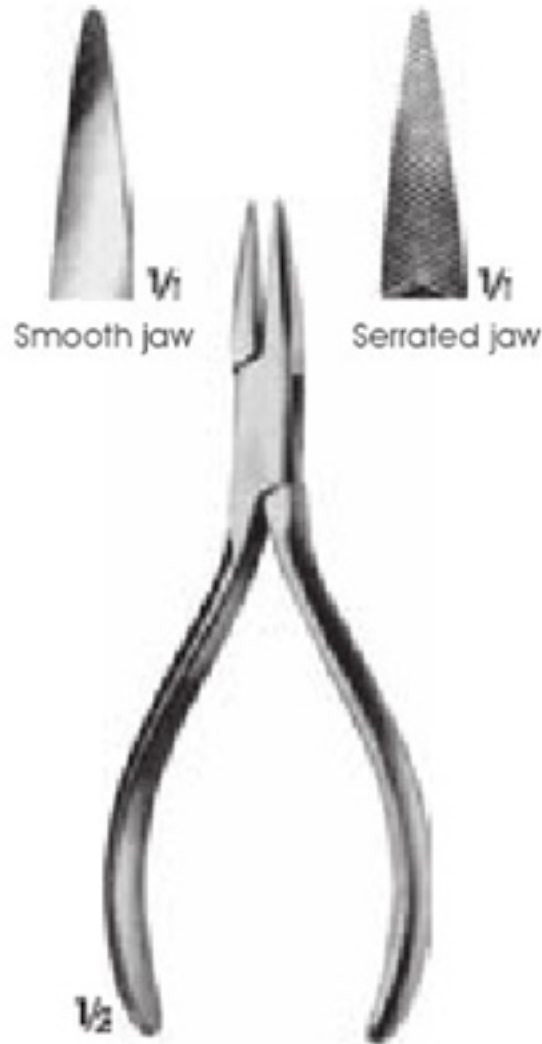

Smooth jaw

Serrated jaw

GOSLEE  
 EM-21-3247  
 Wire twister, flat nosed  
 14 cm



EM-21-3248  
 15 cm



EM-21-3249  
 1.5 mm



EM-21-3250  
 20 cm



EM-21-3251-02  
 To be use with  
 EM-21-3251-03 - EM-21-3251-04



EM-21-3251-01  
 Guide  
 23 cm



EM-21-3251-03  
 ∅ 2.5 mm



EM-21-3251-04  
 Pin/Pin

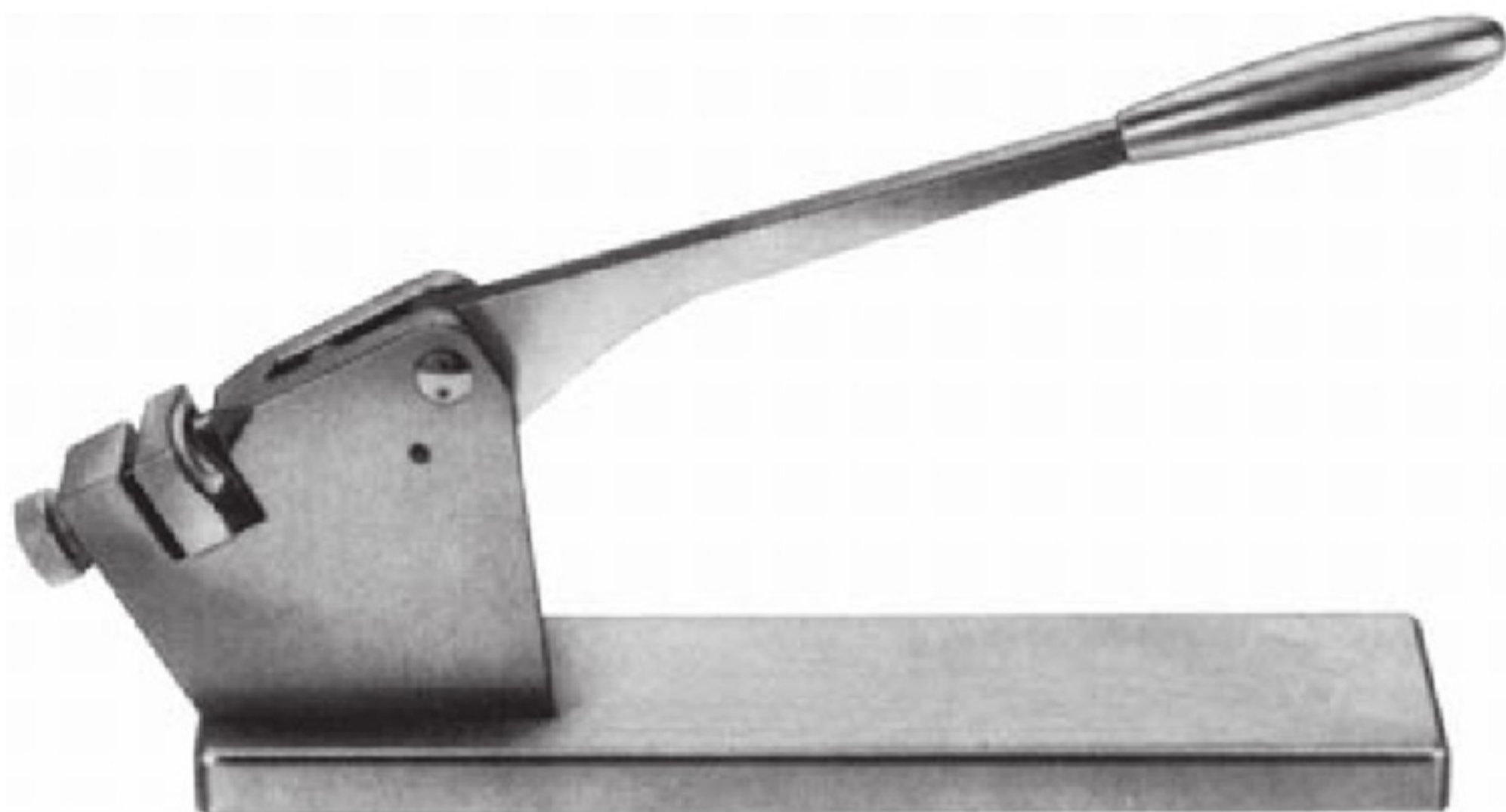
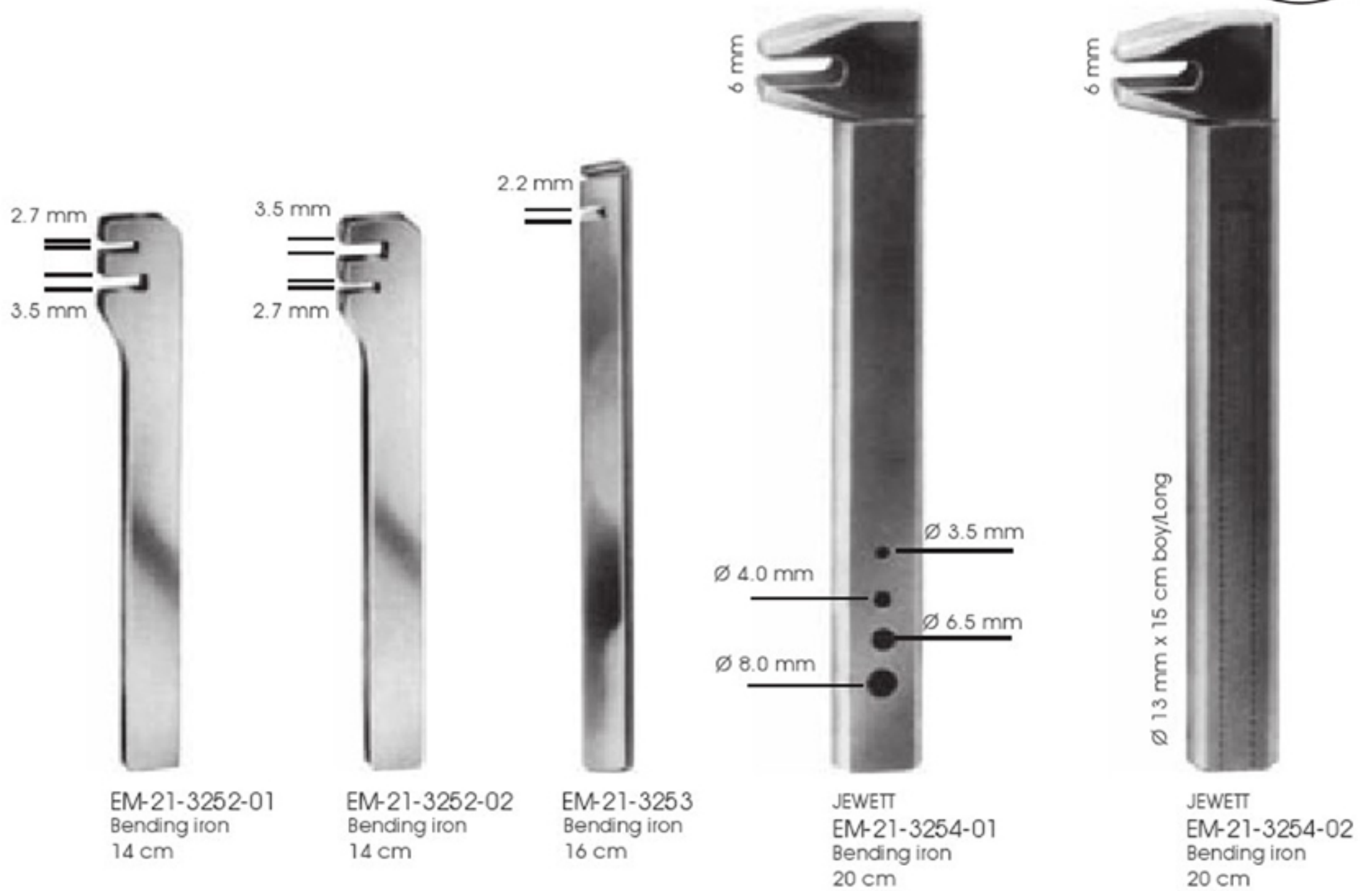

EM-21-3255  
Plate bending and contouring device



EM-21-3256-02  
10 cm



EM-21-3256-01  
10 cm



EM-21-3257-01 Ø 2.5 mm  
 EM-21-3257-02 Ø 3.5 mm  
 14 cm



EM-21-3258-01 Ø 3.5 mm  
 18 cm



EM-21-3259  
20 cm



EM-21-3258-02 9 mm  
 Broken screw extractor guj  
 22 cm

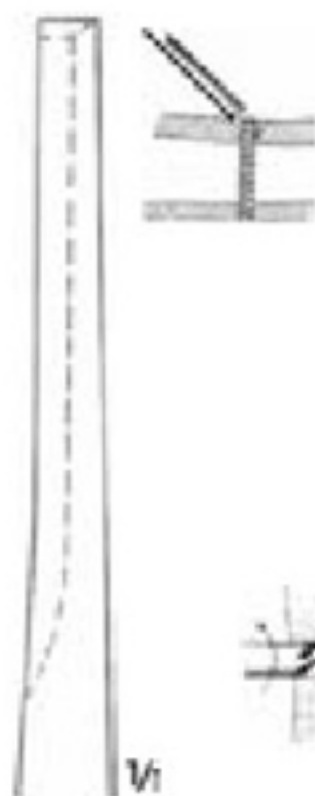

Vi

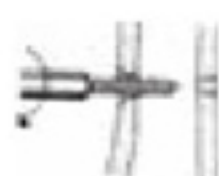
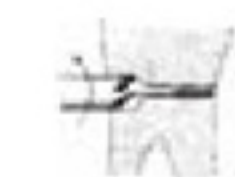

EM-21-3260-01 Ø 3.5 mm  
 EM-21-3260-02 Ø 4.5 mm  
 EM-21-3260-03 Ø 6.5 mm

EM-21-3263-01 Ø 3.5 mm  
 EM-21-3263-02 Ø 4.5 mm  
 EM-21-3263-03 Ø 6.5 mm

EM-21-3262-01 Ø 3.5 mm  
 EM-21-3262-02 Ø 4.5 mm  
 EM-21-3262-03 Ø 6.5 mm

EM-21-3261-01 Ø 3.5 mm  
 EM-21-3261-02 Ø 4.5 mm  
 EM-21-3261-03 Ø 6.5 mm



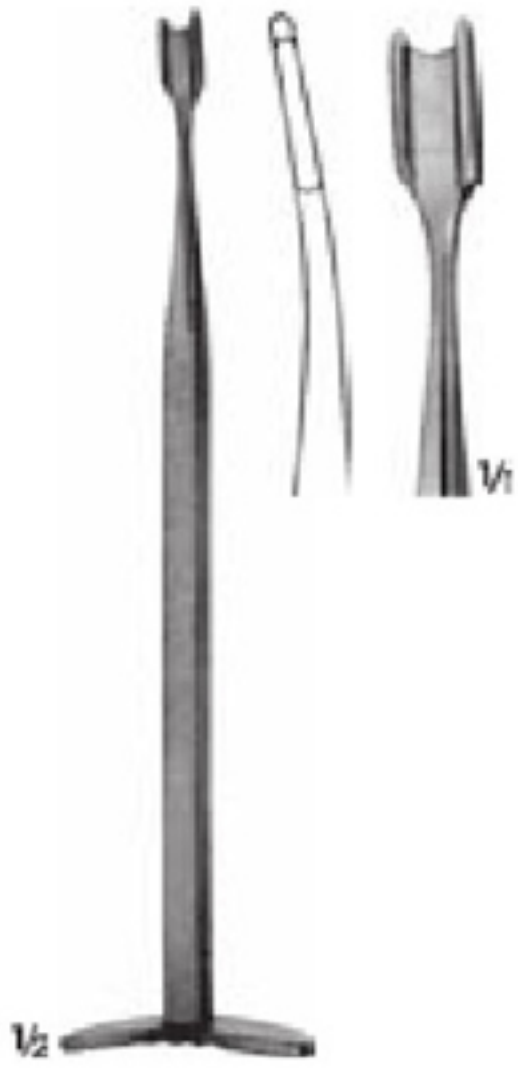

SMILLIE  
 EM-21-3264  
 Meniscus knife  
 17 cm

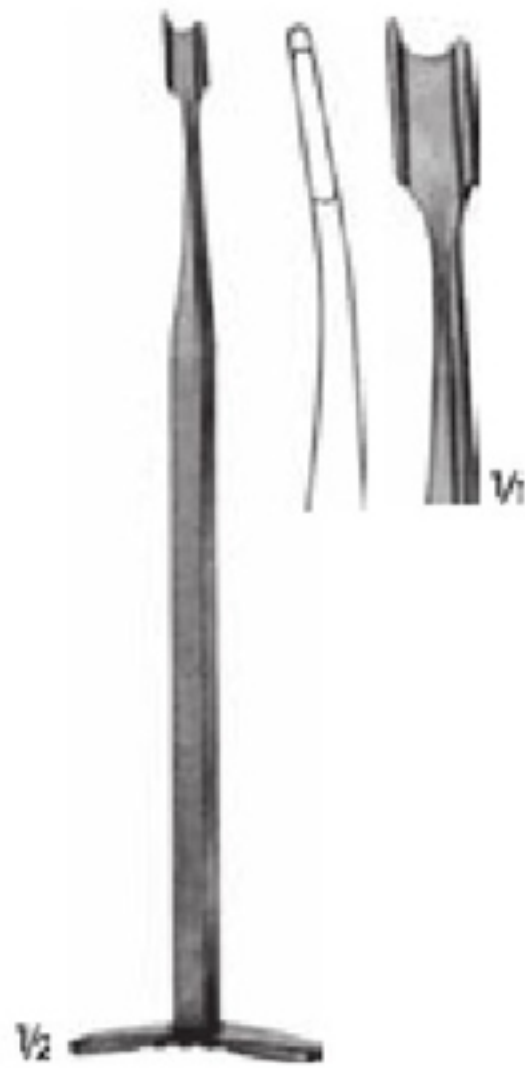

SMILLIE  
 EM-21-3265  
 Meniscus knife  
 17 cm

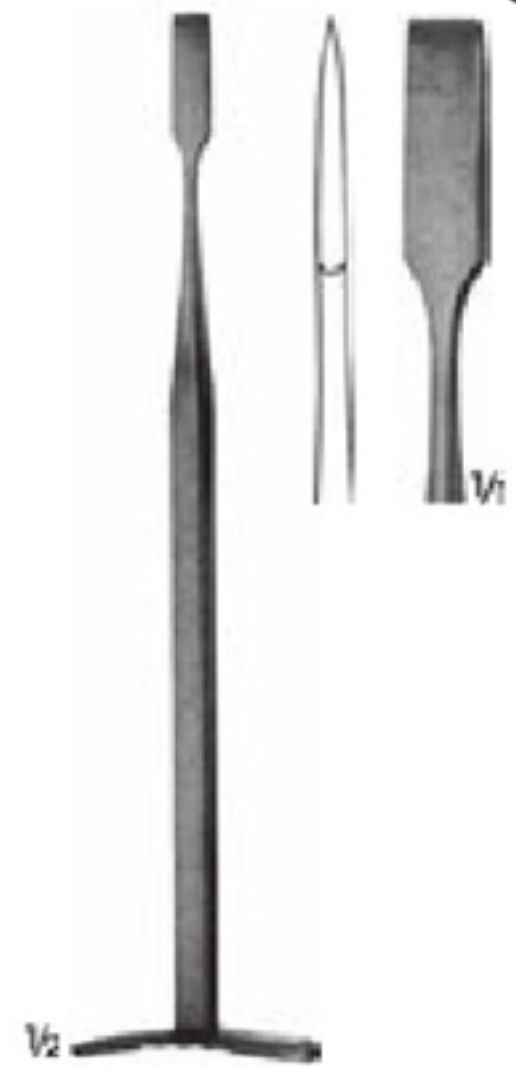

SMILLIE  
 EM-21-3266  
 Meniscus knife  
 17 cm

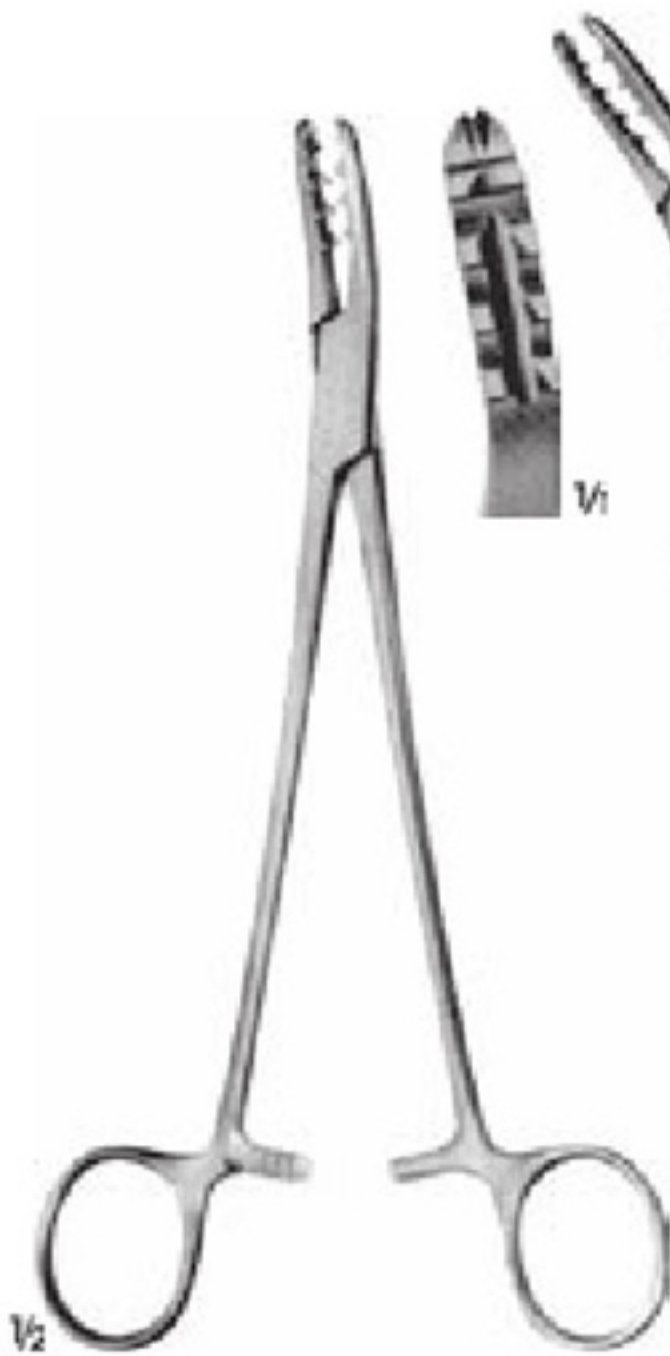

BIRCHER-GANSKE  
 EM-21-3267-01 - 3267-02  
 Meniscus forcep  
 20 cm



WELLER  
 EM-21-3268  
 Meniscus forcep  
 20 cm



EM-21-3269  
 Meniscus forcep  
 20.5 cm

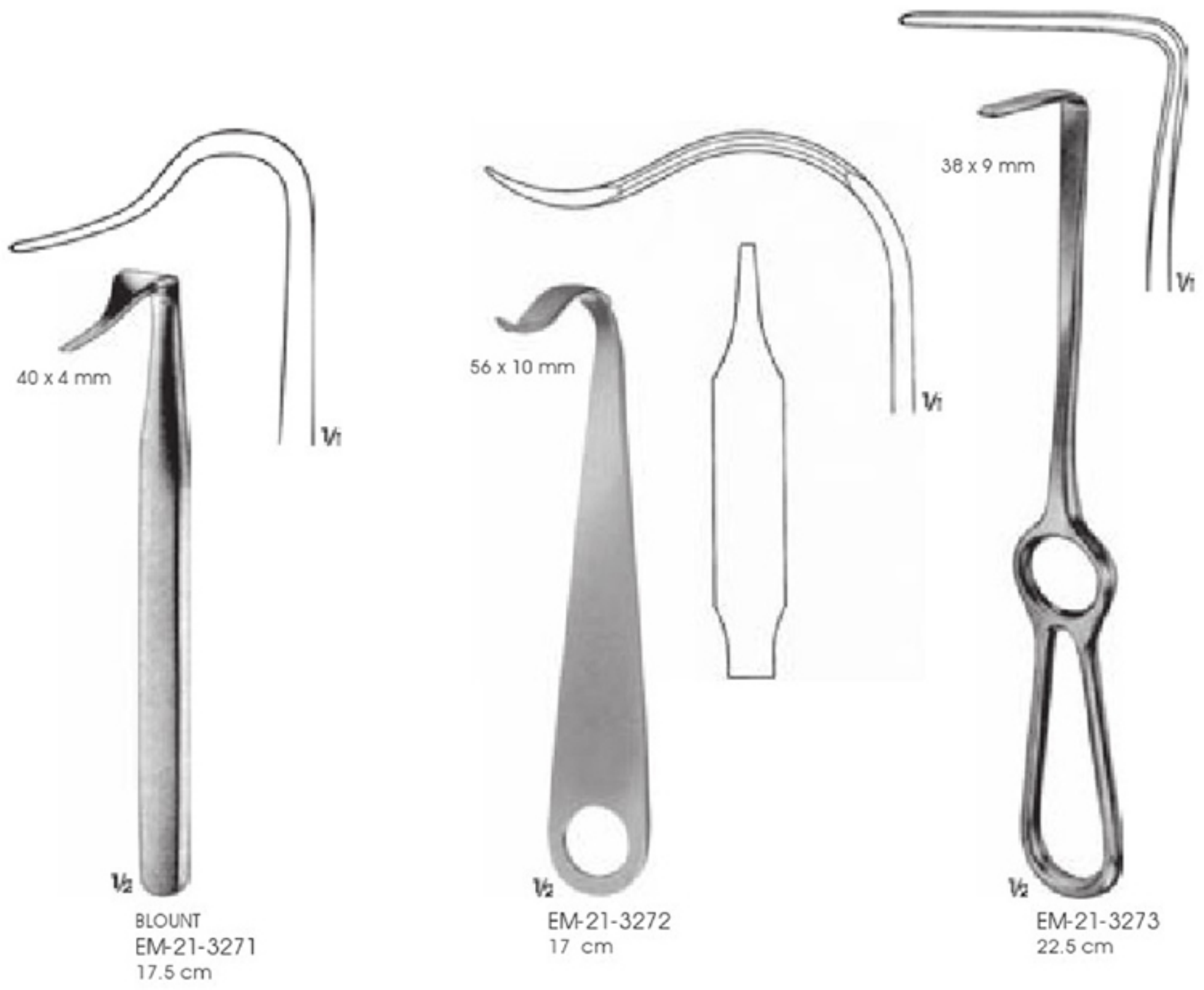
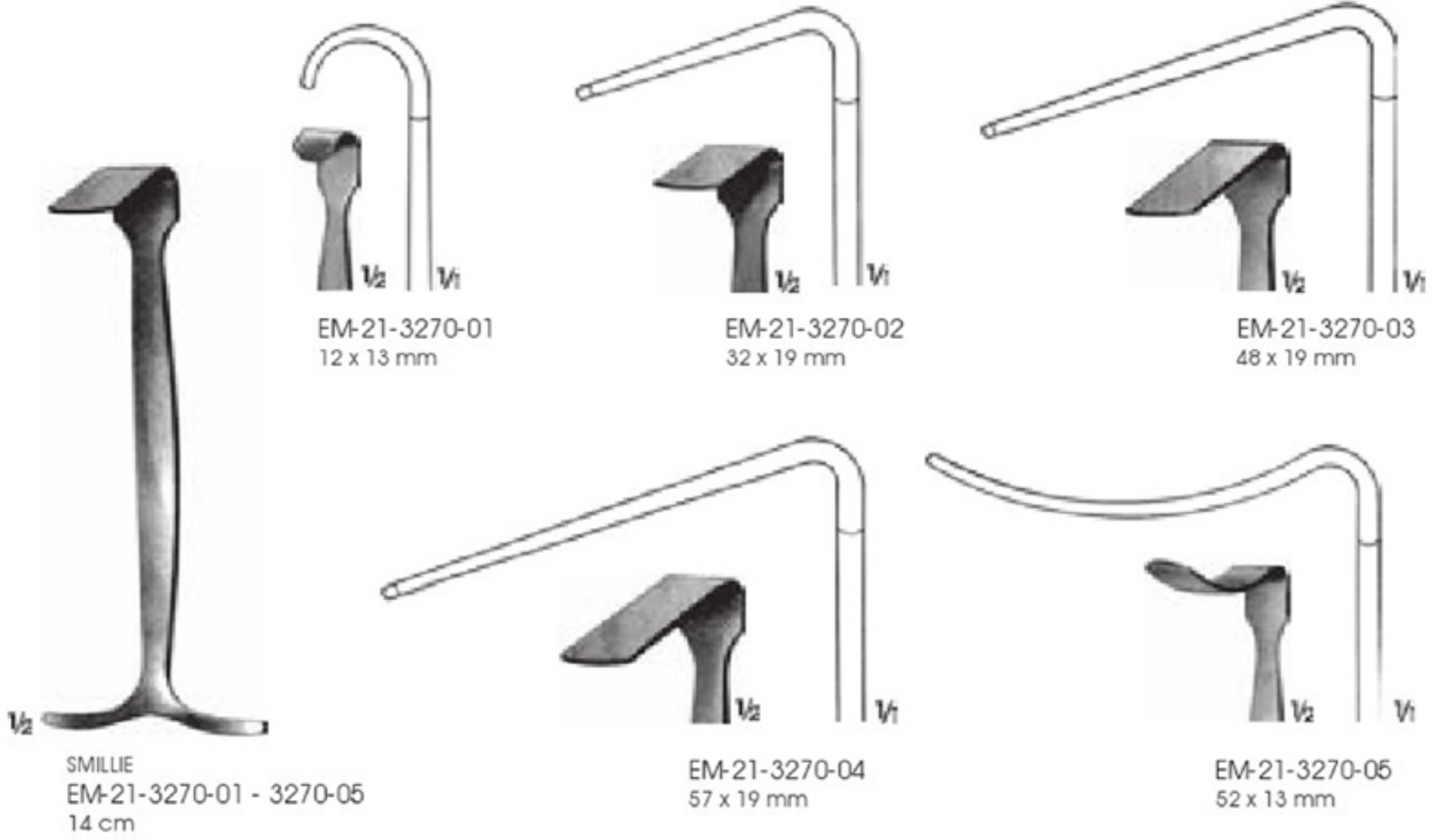



KUNTSCHER  
EM-21-3274-01 Ø 6 mm  
EM-21-3274-02 Ø 7 mm  
EM-21-3274-03 Ø 8 mm  
EM-21-3274-04 Ø 9 mm  
EM-21-3274-05 Ø 10 mm  
EM-21-3274-06 Ø 11 mm  
EM-21-3274-07 Ø 12 mm  
EM-21-3274-08 Ø 13 mm  
EM-21-3274-09 Ø 14 mm  
EM-21-3274-10 Ø 15 mm  
EM-21-3274-11 Ø 16 mm  
Fixed reamer  
50 cm



KUNTSCHER  
EM-21-3275-01 Ø 6 mm  
EM-21-3275-02 Ø 7 mm  
EM-21-3275-03 Ø 8 mm  
EM-21-3275-04 Ø 9 mm  
EM-21-3275-05 Ø 10 mm  
EM-21-3275-06 Ø 11 mm  
EM-21-3275-07 Ø 12 mm  
EM-21-3275-08 Ø 13 mm  
EM-21-3275-09 Ø 14 mm  
EM-21-3275-10 Ø 15 mm  
EM-21-3275-11 Ø 16 mm  
Malleable reamer  
48 cm

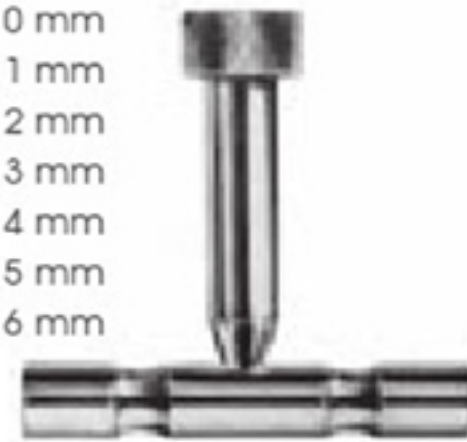

EM-21-3276  
"T" Wrench, for malleable  
reamers



EM-21-3277  
Extractor  
25 cm



EM-21-3278  
Extractor  
27 cm



EM-21-3279  
Pusher  
25 cm



EM-21-3280  
MORE protheses extractor  
50 cm

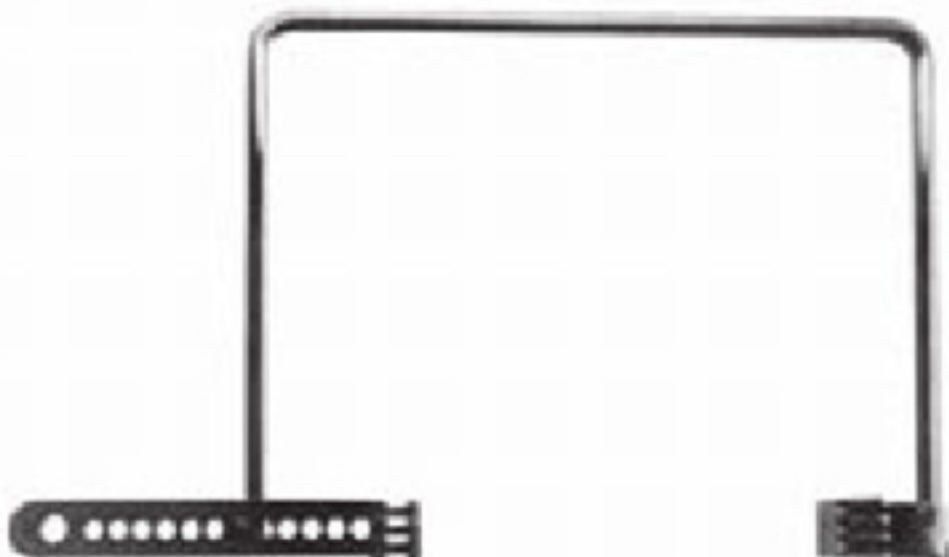

EM-21-3281  
Hip retractor



EM-21-3282  
Weight with chain  
1 kg



EM-21-3283  
Cement pusher  
30 cm

EM-21-3284  
Cement pusher  
30 cm

EM-21-3285-01 - 3286-03  
Chisel and gouge  
35 cm



EM-21-3287  
40 cm

EM-21-3288  
Ø 6 mm  
40 cm

EM-21-3289  
Ø 8 mm  
40 cm

EM-21-3290  
Ø 10 mm  
40 cm

EM-21-3291  
Mallet  
22 cm

EM-21-3292-01 Ø 7 mm  
EM-21-3292-02 Ø 9 mm  
EM-21-3292-03 Ø 11 mm  
Cement extractor  
60 cm



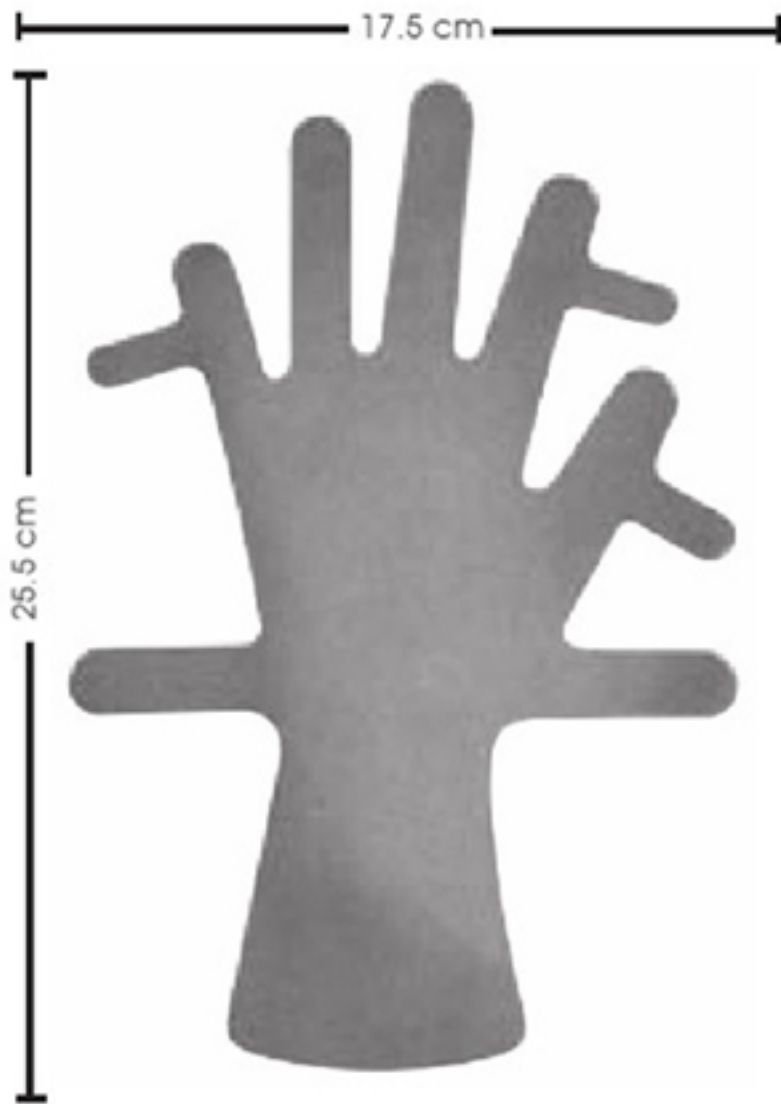

EM-21-3293-01  
Children's hand control, soft

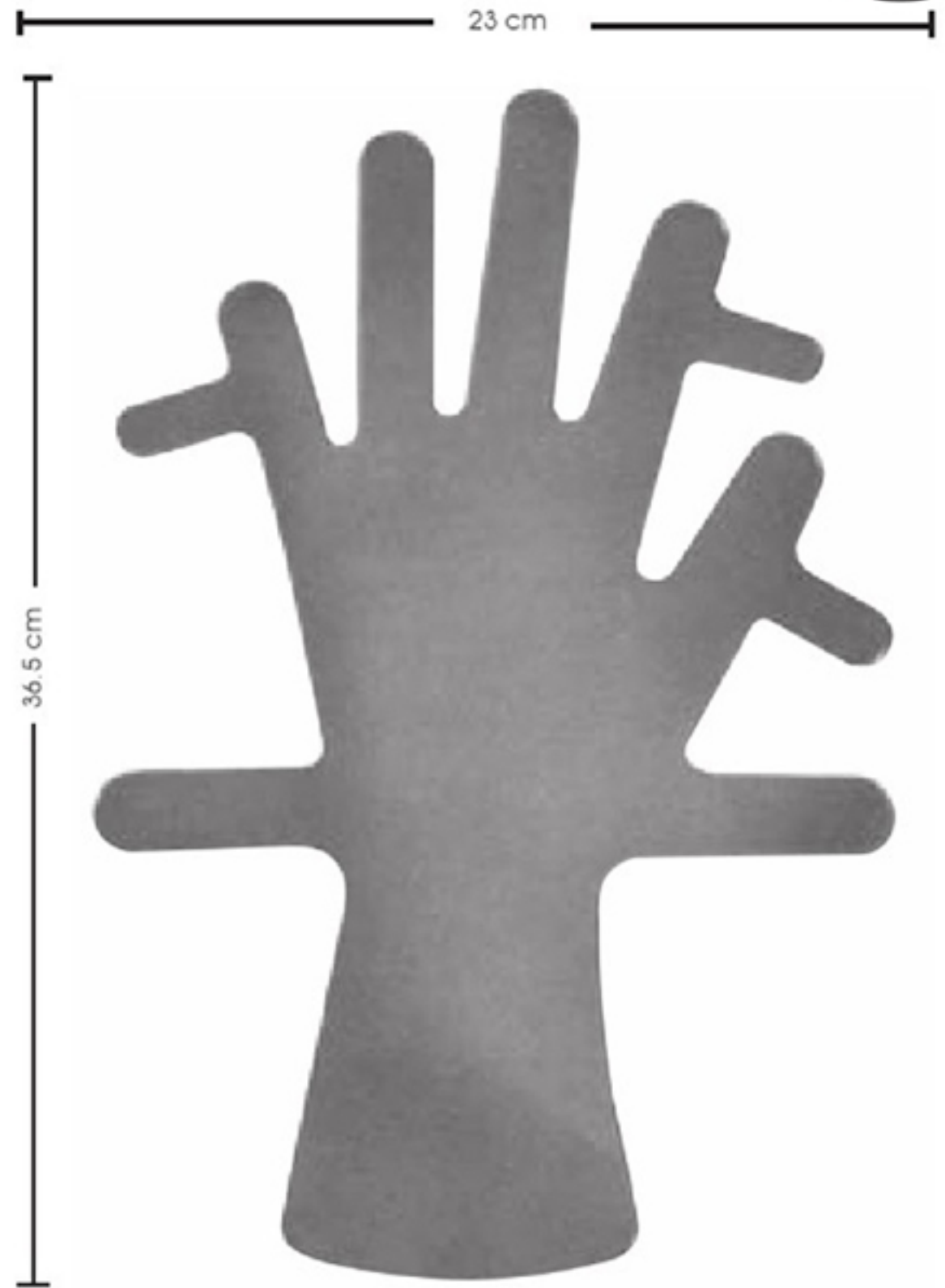

EM-21-3293-02  
Used stabilizer for adults, soft

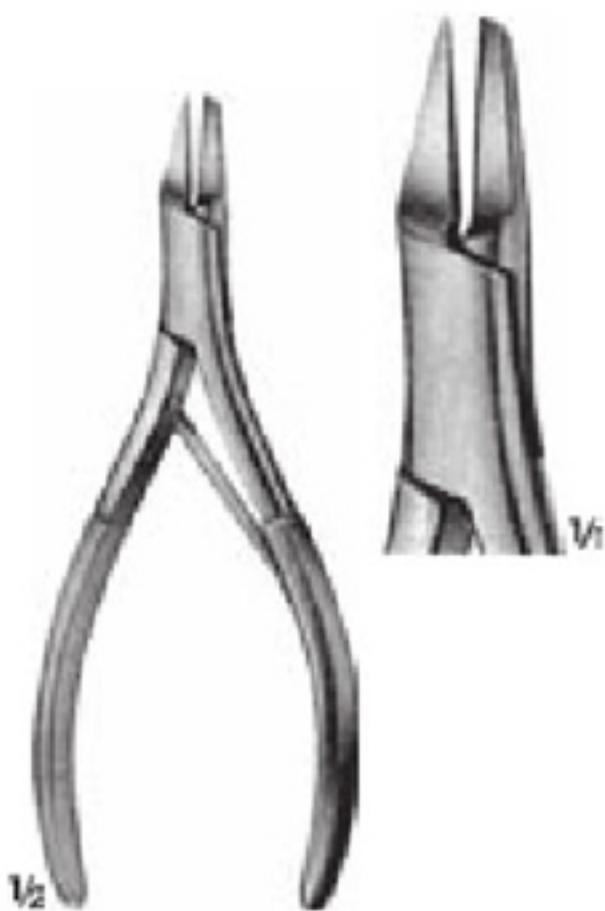

EM-21-3294  
Nail splitting forceps  
13 cm



EM-21-3295  
Nail extracting forceps  
13.5 cm



EM-21-3296  
Finger ring saw  
15 cm

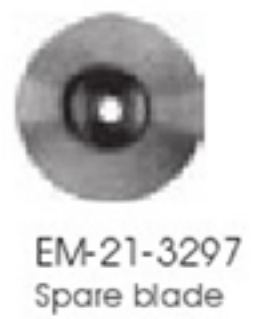

EM-21-3297  
Spare blade



$\frac{1}{2}$   
JOSEPH  
EM-21-3298  
Hand saw  
17 cm



$\frac{1}{2}$   
LINDEMANN  
EM-21-3299  
Hand saw  
20 cm



$\frac{1}{2}$   
SYSTRUNK  
EM-21-3300  
Scissors for splitting finger nails  
13 cm

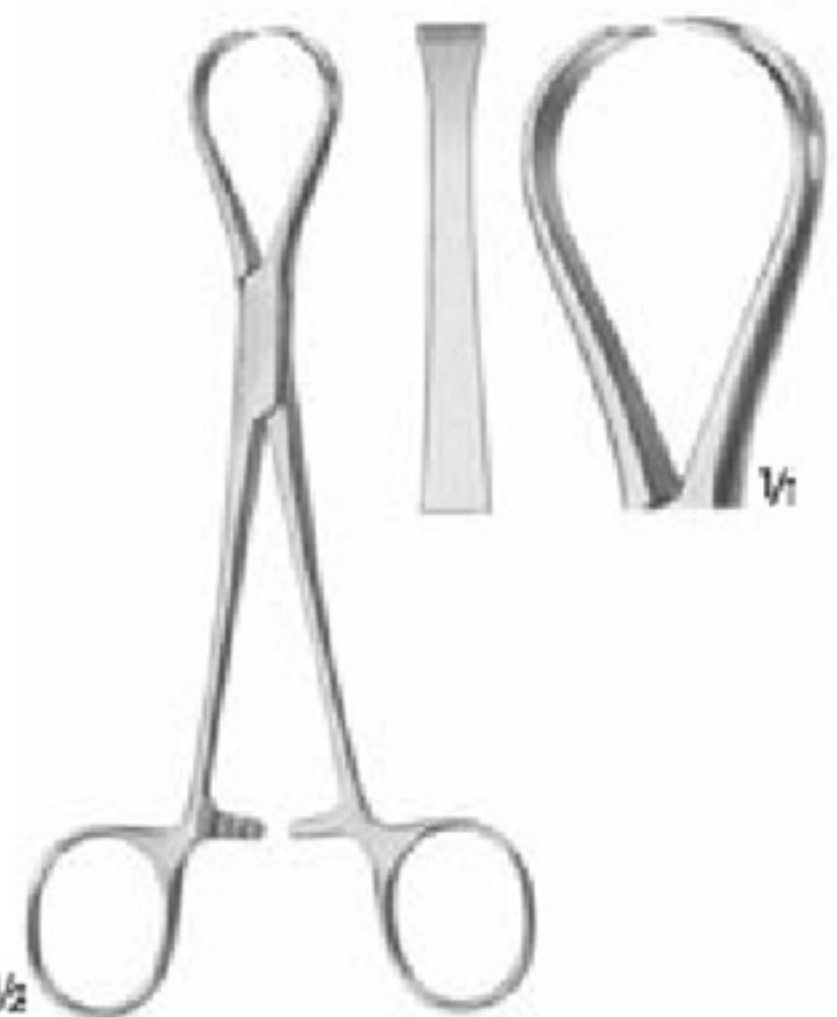

JACKSON  
EM-21-3301  
Tendon seizing forcep  
4 x 5 teeth  
15 cm



$\frac{1}{2}$   
HERZ  
EM-21-3302  
Tendon seizing forcep  
15.5 cm

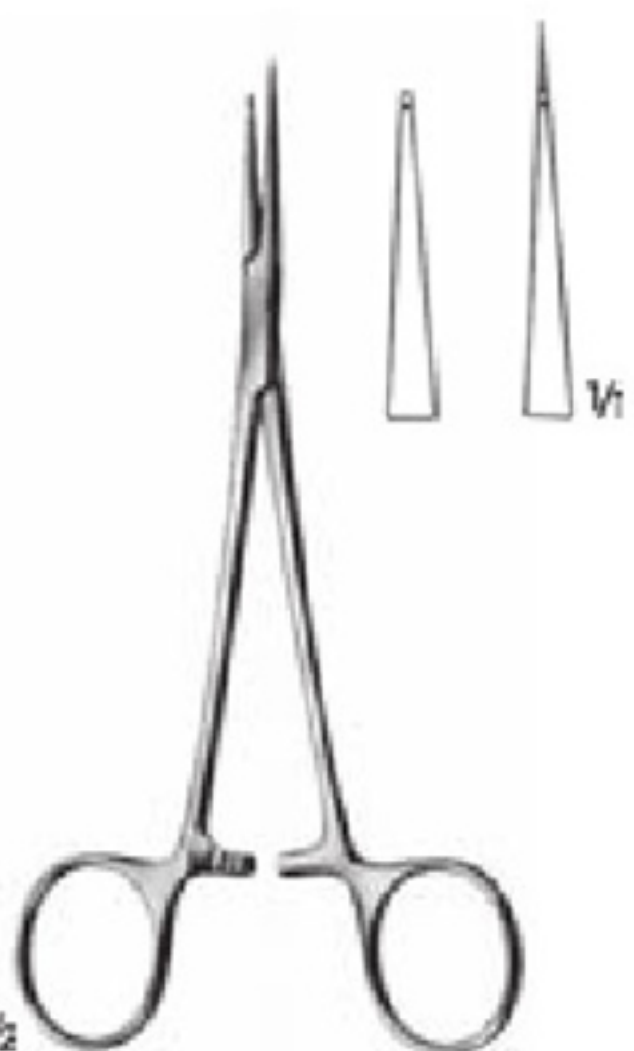

$\frac{1}{2}$   
EM-21-3303  
Tendon interfacing forcep  
15 cm

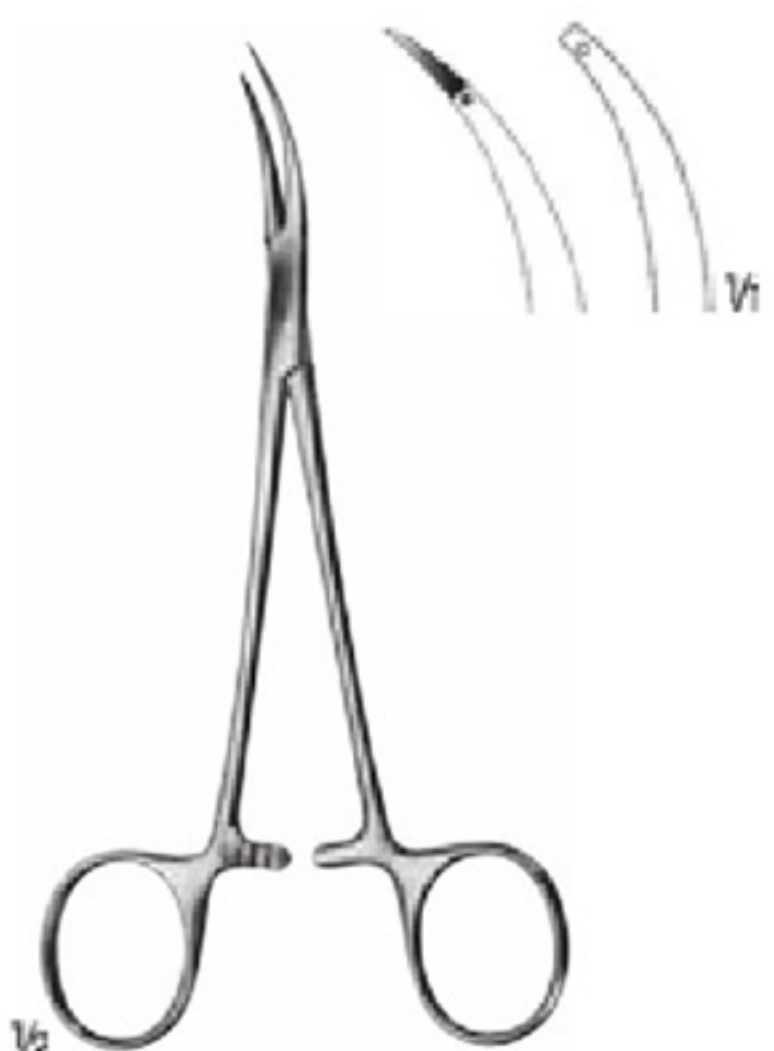

$\frac{1}{2}$   
EM-21-3304  
Tendon interfacing forcep  
15 cm



EM-21-3305-01 Ø 3 mm  
Tendon stripper  
Schafflänge 19 cm  
Shaft length 30 cm

EM-21-3305-02 Ø 5 mm  
Tendon stripper  
Schafflänge 39 cm  
Shaft length 49.5 cm

REILL  
EM-21-3306-01 Ø 4 mm  
EM-21-3306-02 Ø 6 mm  
Tendon stripper  
Schafflänge 35 cm  
Shaft length 39.5 cm

ASSMUS  
EM-21-3307 Ø 3 mm  
Nerve stripper, blunt  
Schafflänge 35 cm  
Shaft length 39.5 cm





EM-21-3308-01 Ø 2.5 mm  
 EM-21-3308-02 Ø 2.5 mm  
 EM-21-3308-03 Ø 3.0 mm

EM-21-3308-01 14.5 cm  
 EM-21-3308-02 16 cm  
 EM-21-3308-03 20 cm  
 Probes with eye



BUNNELL  
 EM-21-3309  
 23 cm



BUNNELL  
 EM-21-3310-01 Ø 2 mm  
 EM-21-3310-02 Ø 3 mm  
 EM-21-3310-03 Ø 4 mm  
 EM-21-3310-04 Ø 6 mm  
 13.5 cm

C  
 EM-21-3310-01

C  
 EM-21-3310-02

C  
 EM-21-3310-03

C  $\nabla$   
 EM-21-3310-04



$\nabla$



EM-21-3311-01



EM-21-3311-02

EM-21-3311-01 Ø 3 mm  
 EM-21-3311-02 Ø 5 mm  
 EM-21-3312 Ø 5 mm  
 50 cm