



Dermatology

Dermatologie



- ◻ EM-23-3348-02 Ø 2 mm
- EM-23-3348-03 Ø 3 mm
- EM-23-3348-04 Ø 4 mm
- EM-23-3348-05 Ø 6 mm
- EM-23-3348-06 Ø 7 mm

Dermal punches

KEYES
 EM-23-3348-01 - 3348-06
 10 cm



KEYES
 EM-23-3348-01
 Dermal punch, complete with 5
 interchangeable tips, handle and
 rack

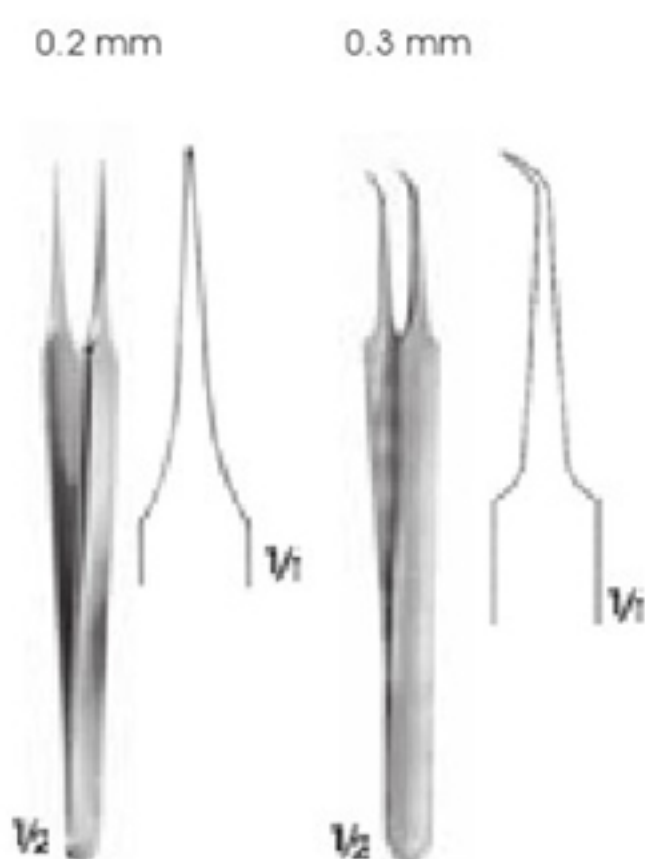

EM-23-3349
 11 cm

EM-23-3350
 11 cm

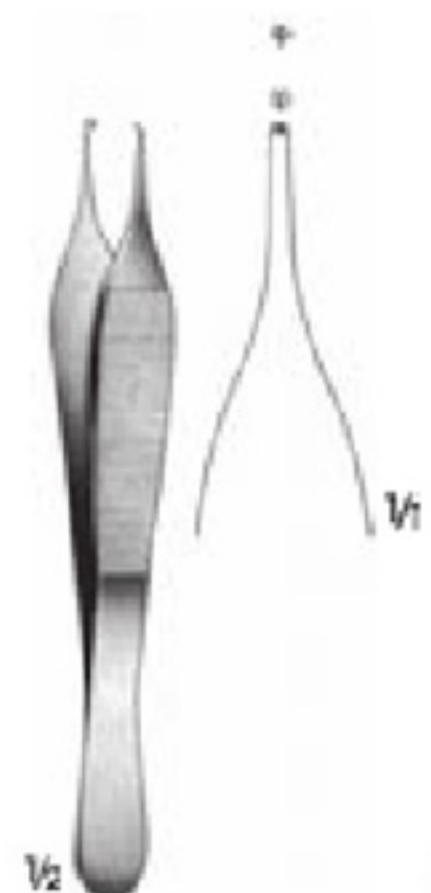

ADSON
 EM-23-3351
 12 cm

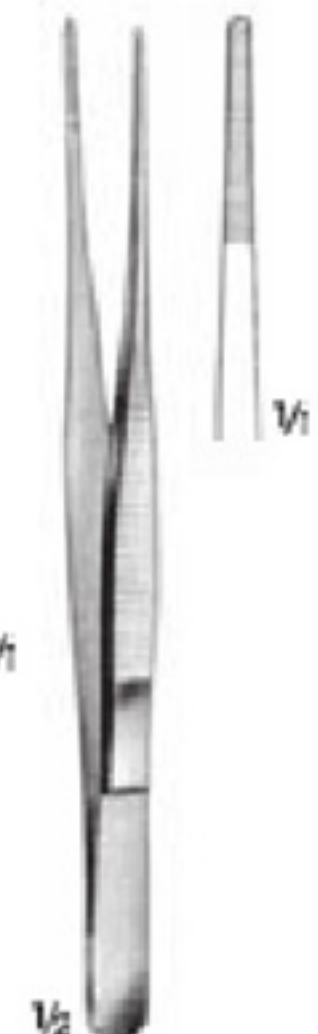

EM-23-3352
 15.5 cm

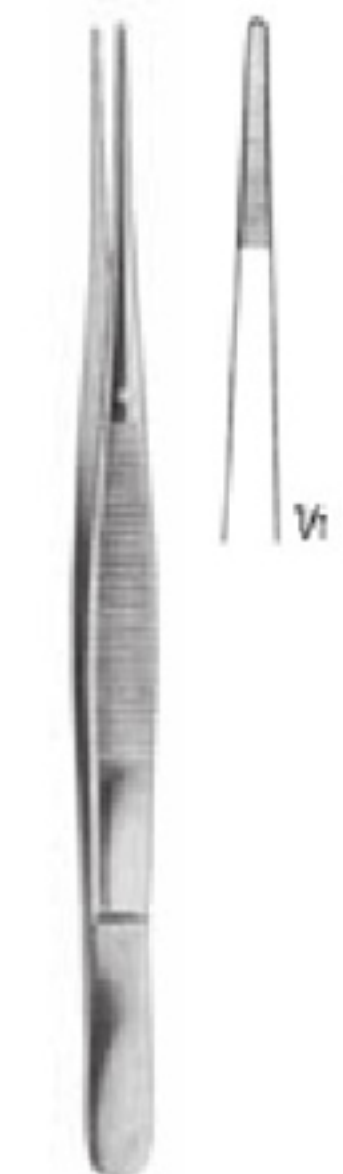

CUSHING
 EM-23-3353
 20 cm

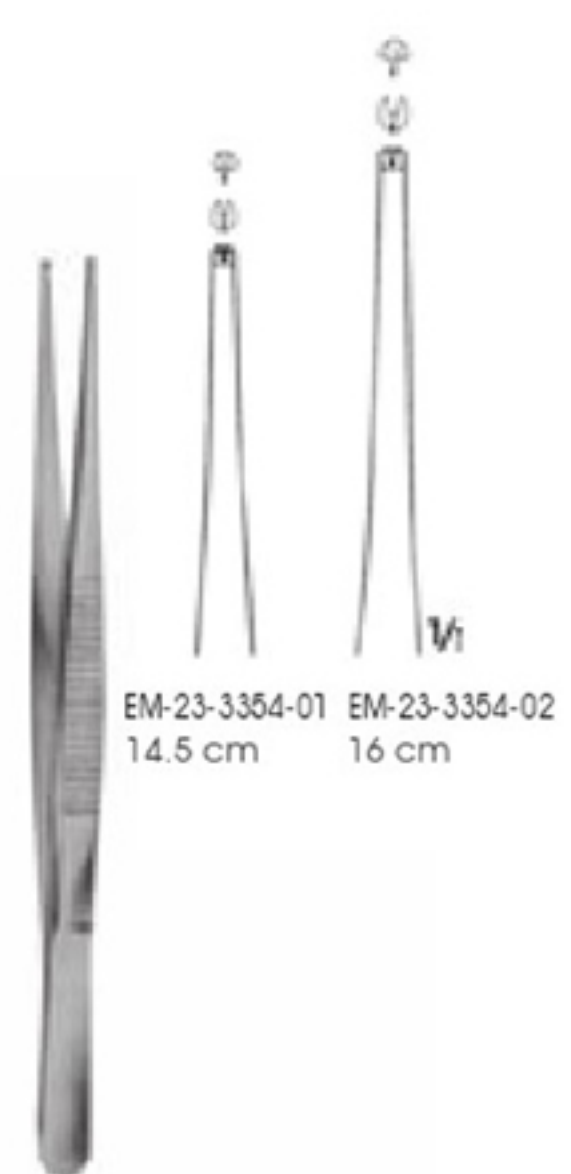

EM-23-3354-01 14.5 cm
 EM-23-3354-02 16 cm

EM-23-3354-01 - 3354-02



EM-23-3355
8 cm

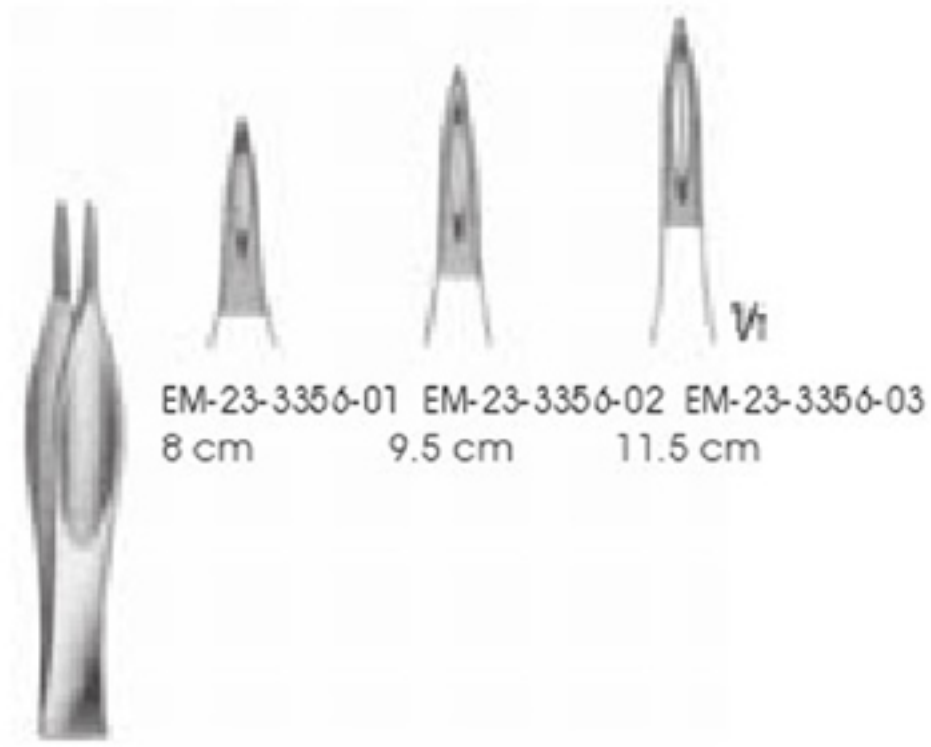

FEILCHENFELD
EM-23-3356-01 - 3356-03

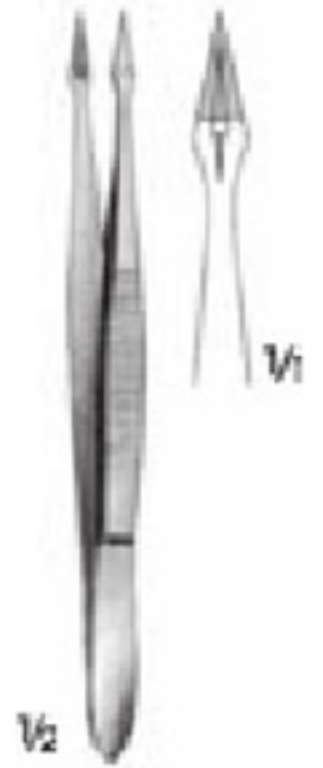

HUNTER
EM-23-3357
10.5 cm



STIEGLITZ
EM-23-3358
14 cm



STIEGLITZ
EM-23-3359
14 cm



PEET
EM-23-3360
12 cm

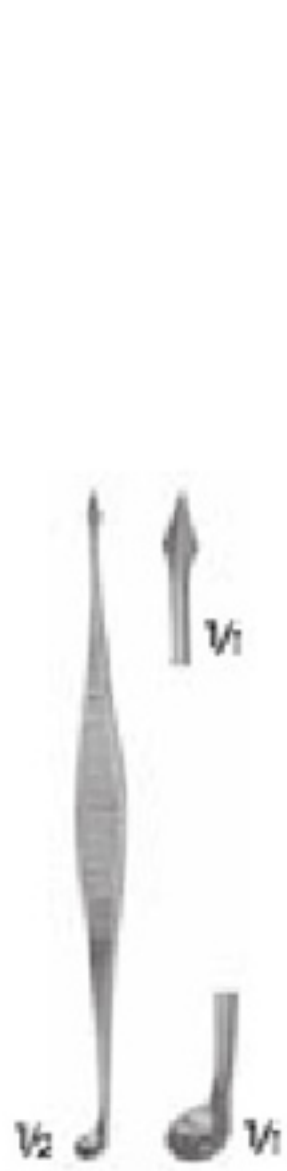

SAALFELD
EM-23-3361
10 cm

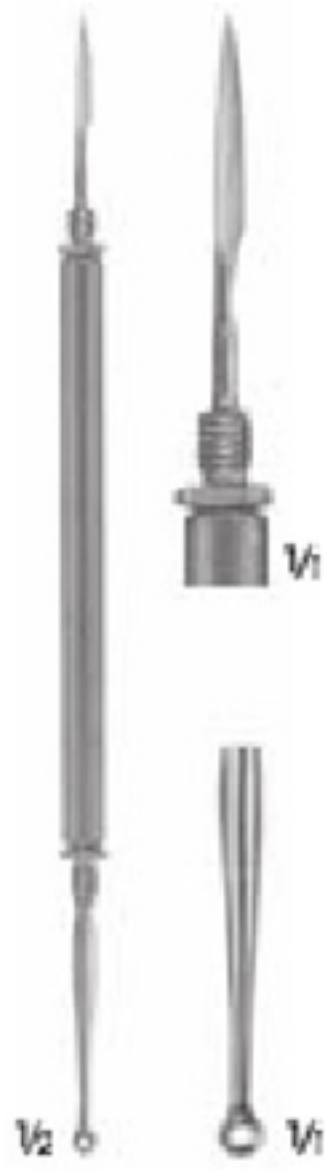

HEBRA
EM-23-3362
18 cm



EM-23-3363
14.5 cm



UNNA
EM-23-3364
14 cm



VIDAL
EM-23-3365
13.5 cm



KILNER
EM-23-3366
16 cm



SCHAMBERG
EM-23-3367
10 cm



FOX
EM-23-3368-01 - 3368-04
14 cm

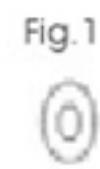

EM-23-3369-01
4.3 mm



EM-23-3369-03
5.8 mm



EM-23-3369-05
6.4 mm

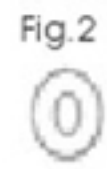

EM-23-3369-02
5.3 mm

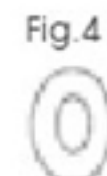

EM-23-3369-04
6.3 mm



EM-23-3369-06
7.2 mm



WOLFF
EM-23-3369-01 - 3369-06
14 cm



SILVER
EM-23-3370
Skin graft knife, without blade
19 cm



SCHINK
EM-23-3371-01
Dermatom only
30 cm

EM-23-3372-01
Spare blade only

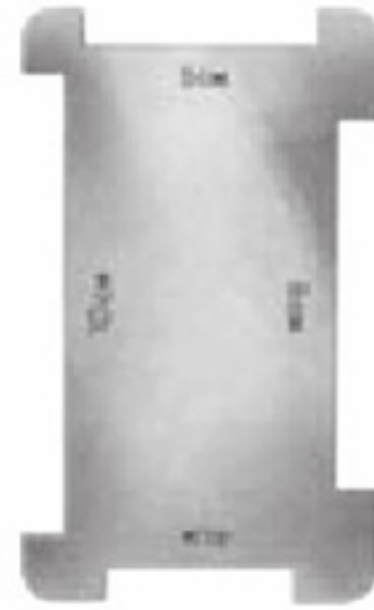

EM-23-3372-02
Skin straightening plate
only

Bar fixed



WATSON
EM-23-3373
Skin graft knife, without blade
30 cm

SCHINIC
EM-23-3371-02
Dermatome, adjustable from 0.1mm to 2.0 mm,
complete, with 1 interchangeable blade and 2 skin
straightening plates
30 cm