



EXPO-MED

Serving Health & Medical Division Since 1990

04

Chirurgie

Surgery



1/2

HEISTER

EM-6501

Mouth gag

130 mm, 5 1/8"



1/2

DOYEN-JANSEN

EM-6502

Mouth gag

140 mm, 5 1/2"



1/2

DOYEN-COLLIN

EM-6503

Mouth gag

120 mm, 4 3/4"

for children



1/2

MOLT

EM-6504

Mouth gag

100 mm, 4"



1/2

FERGUSSON-ACKLAND

EM-6505

Mouth gag

145 mm, 5 3/4"



1/2

EM-6506

Mouth gag

125 mm, 5"



ROSER-KÖNIG

EM-6507

Mouth gag
160 mm, 6 1/4"



ROSER-KÖNIG

EM-6508

Mouth gag
185 mm, 7 1/4"



HARTMANN

EM-6509

Nasal speculum
145 mm, 5 3/4"

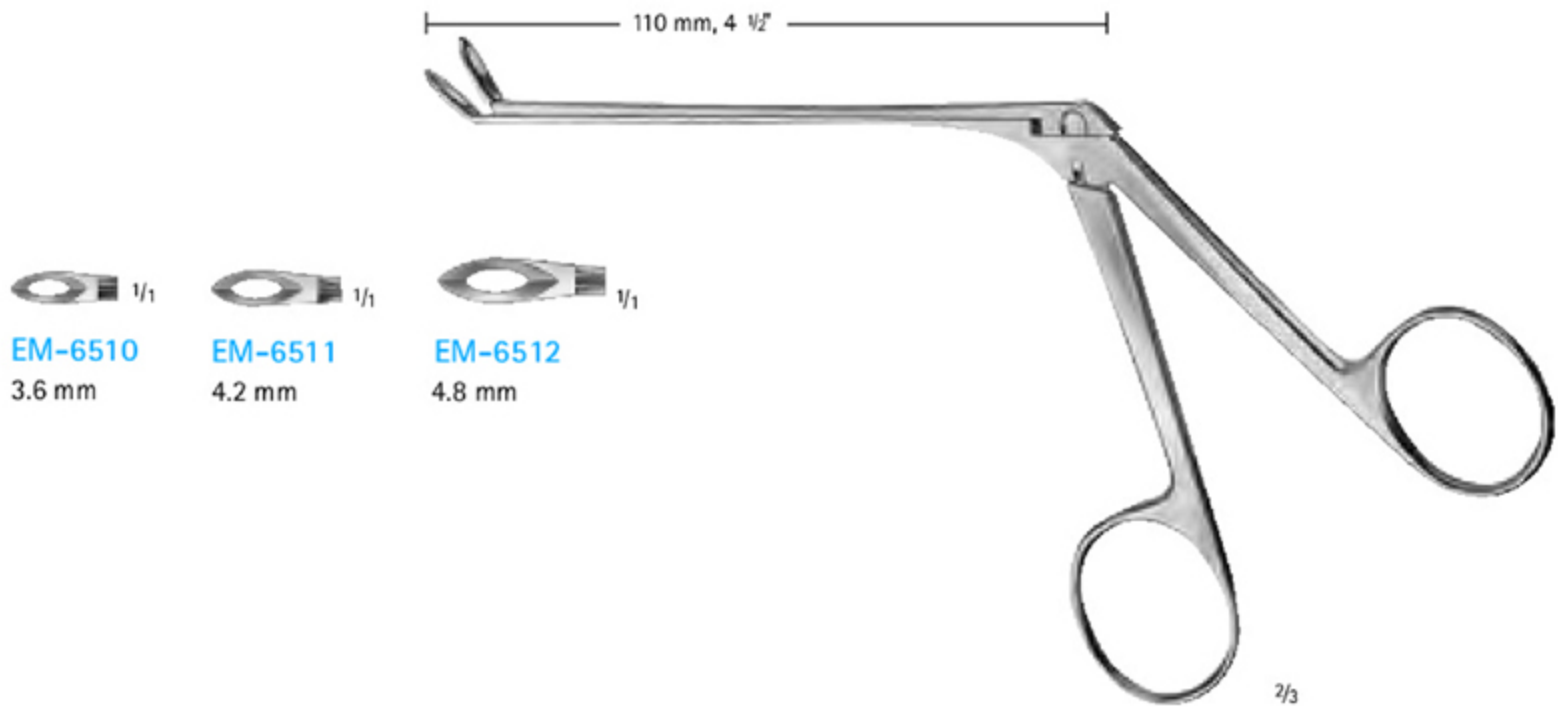

WEIL BLAKESLEY
EM-6510 - EM-6512
Ethmoidal forceps, curved

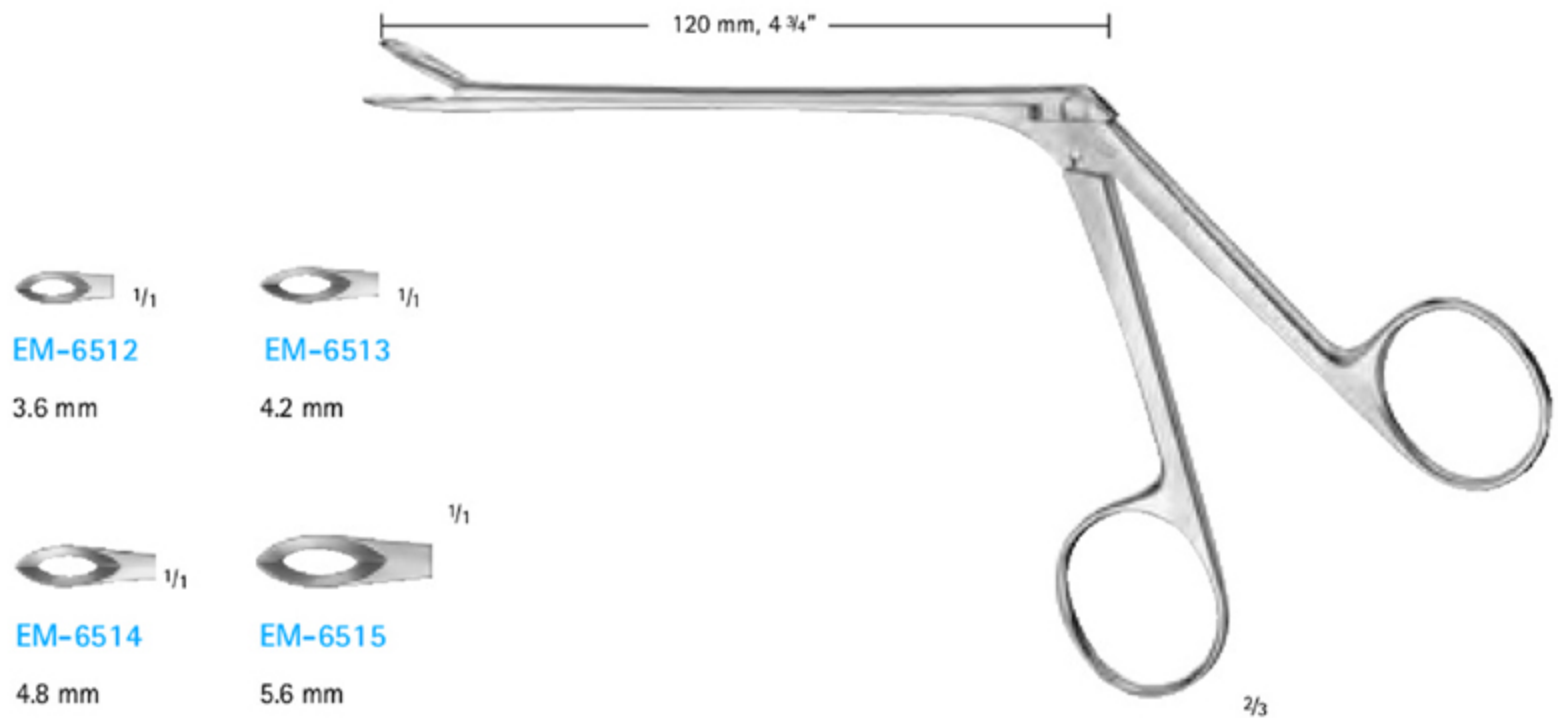

BLAKESLEY-WILDE
EM-6512 - EM-6515
Ethmoidal forceps, straight

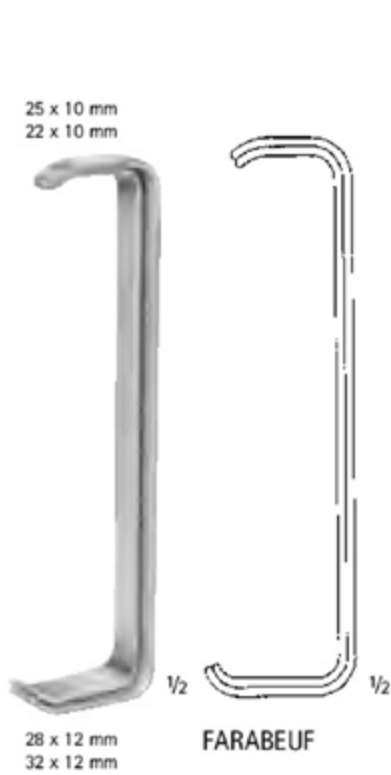

FARABEUFR
EM-6516

Retractor
125 mm, 5"

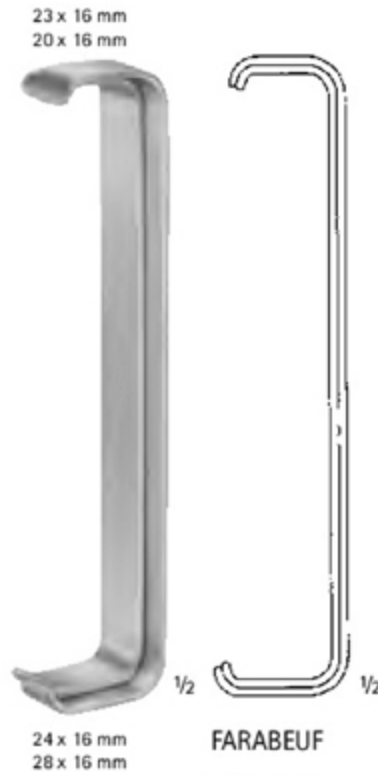

FARABEUFR
EM-6517

Retractor
150 mm, 6"

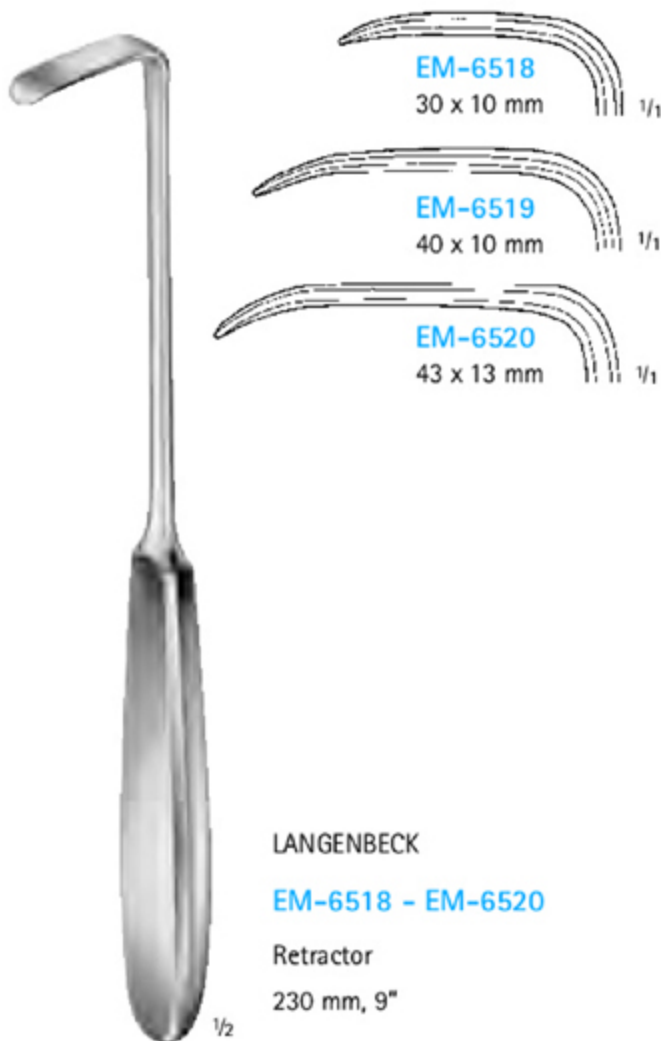

LANGENBECK
EM-6518 - EM-6520

Retractor
230 mm, 9"

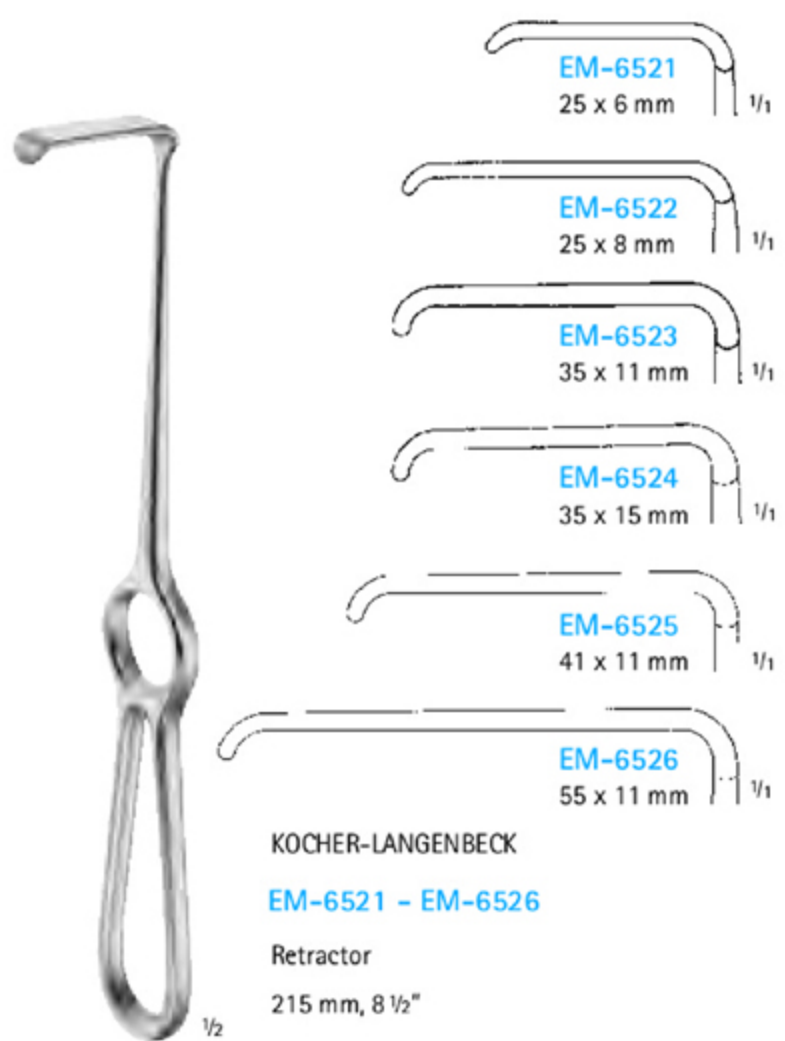

KOCHER-LANGENBECK
EM-6521 - EM-6526

Retractor
215 mm, 8 1/2"

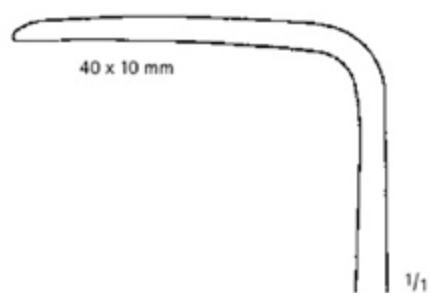

EM-6527
Cheek retractor
215 mm, 8 1/2"

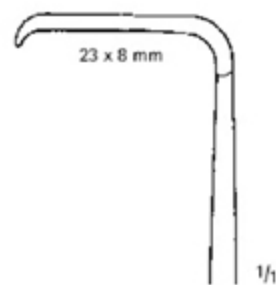

EM-6528
Retractor
210 mm, 8 1/4"

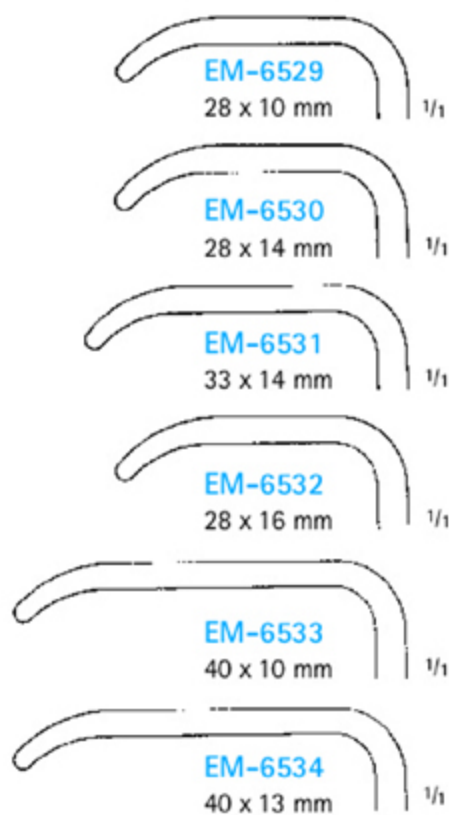

LANGENBECK
EM-6529 - EM-6534
Retractor
210 mm, 8 1/4"

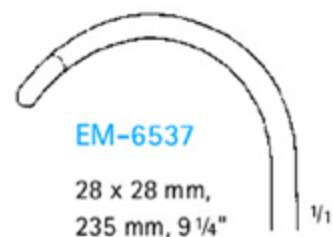

MIDDELDORPF
EM-6535 - EM-6537
Retractor



OBWEGESER
EM-6538 - EM-6543
 Soft tissue retractor
 215 mm, 8 1/2"

1/2

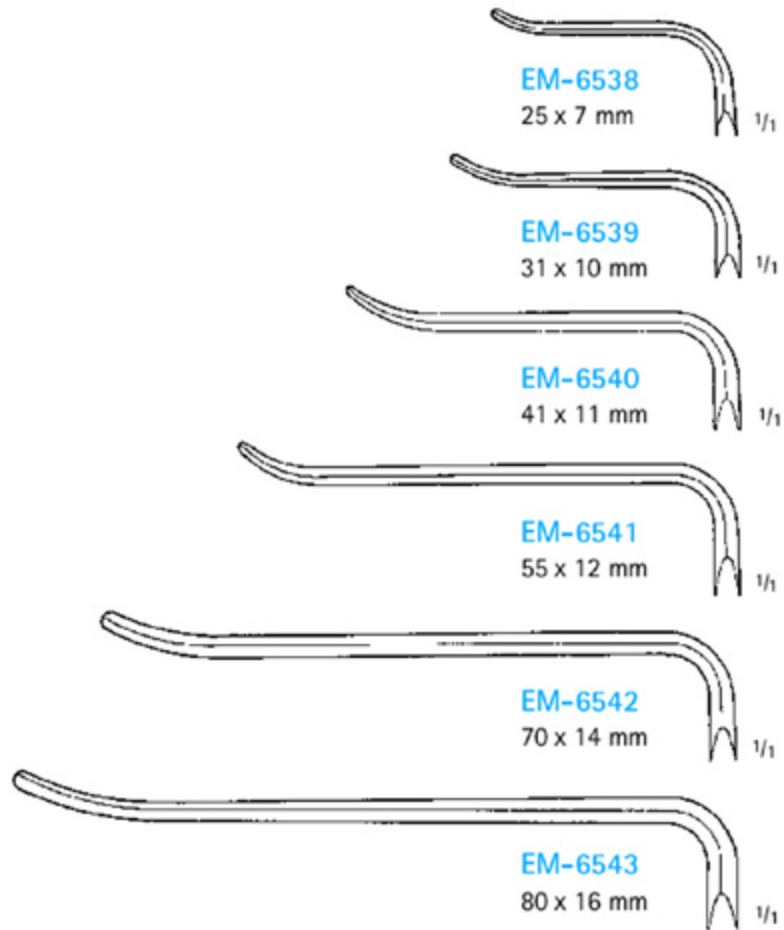

OBWEGESER
EM-6544 - EM-6549
 Soft tissue retractor
 215 mm, 8 1/2"

1/2

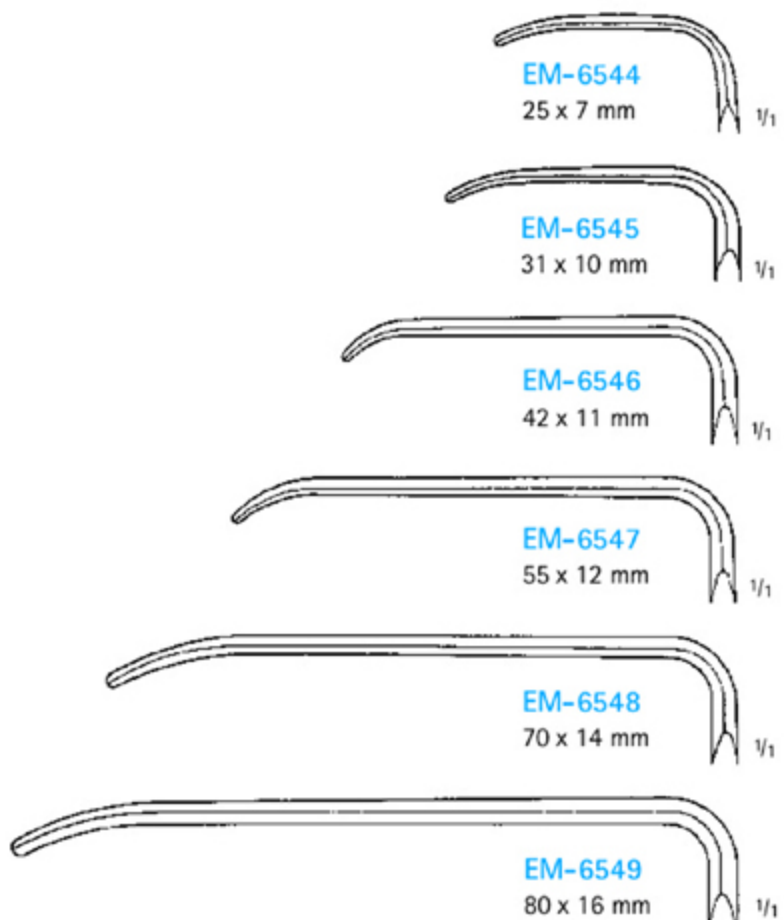



KAY (AUSTIN)
EM-6550
Retractor

1/2



BOWDLER-HENRY
EM-6551
Retractor
190 mm, 7 1/2"

1/2

Especially designed for upper impacted wisdom teeth. The design of the retractor enables the retraction of the cheek and mucoperiosteal flap as well as one hand simultaneous support of retractor and an additional instrument.



LASTER
EM-6552
Cheek retractor
100 mm, 4"

1/2



WARD
EM-6553
Cheek retractor
155 mm, 6"

1/2

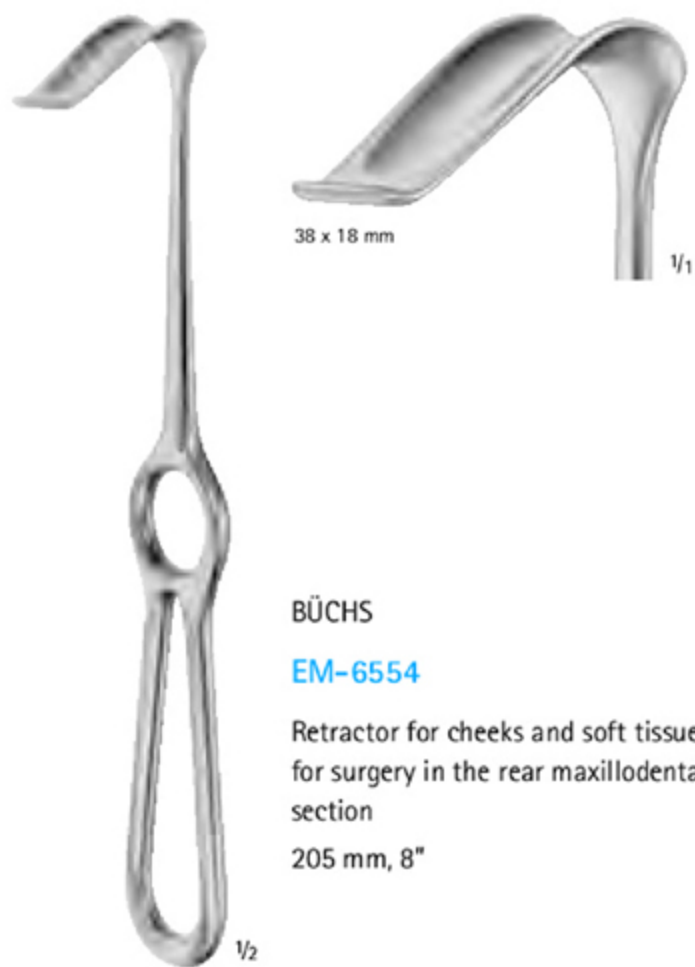

BÜCHS

EM-6554

Retractor for cheeks and soft tissue,
for surgery in the rear maxillo-dental
section

205 mm, 8"



BÜCHS

EM-6555

ERGOPLANT
Soft tissue hook

200 mm, 8"



KIRSCH

EM-6556 - EM-6557

210 mm, 8 1/4"

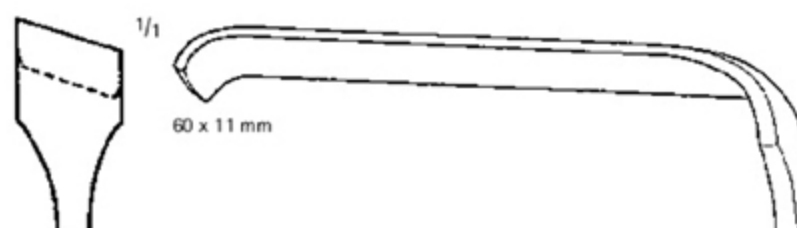

EM-6556

Diagonal cheek retractors for lateral region, particularly
useful for extraction of wisdom teeth for upper left and
bottom right



EM-6557

Diagonal cheek retractors for lateral region, particularly
useful for extraction of wisdom teeth for upper right and
bottom left



OBWEGESER
EM-6578
 Spina-nalis retractor
 215 mm, 8 1/2"

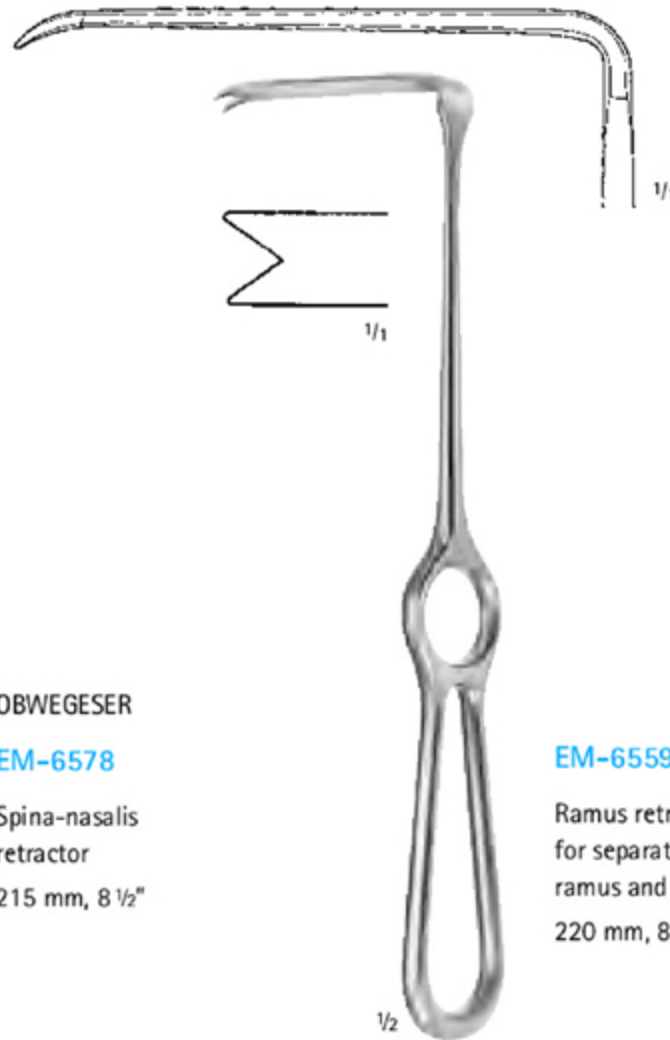

EM-6559
 Ramus retractor
 for separation of
 ramus and tissue
 220 mm, 8 3/4"



WASSMUND
EM-6560
 Retractor
 220 mm, 8 3/4"



EM-6561 wide 20 mm
EM-6562 25 mm
EM-6563 30 mm

EM-6561 - EM-6563
 Ramus retractor
 165 mm, 6 1/2"



DOCKHORN
EM-6564 - EM-6565
 Retractor
 210 mm, 8 1/4"

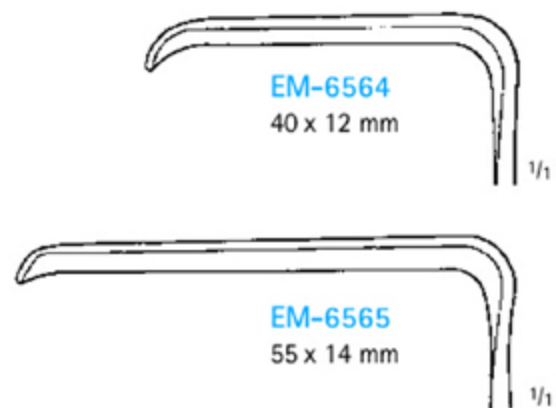



TESSIER
EM-6566

Maxillary mobilizers
right
150 mm, 6"



TESSIER
EM-6567

Maxillary mobilizers
left
150 mm, 6"



OBWEGESER
EM-6568 8 mm
EM-6569 10 mm
Channeled retractor
165 mm, 6 1/2"

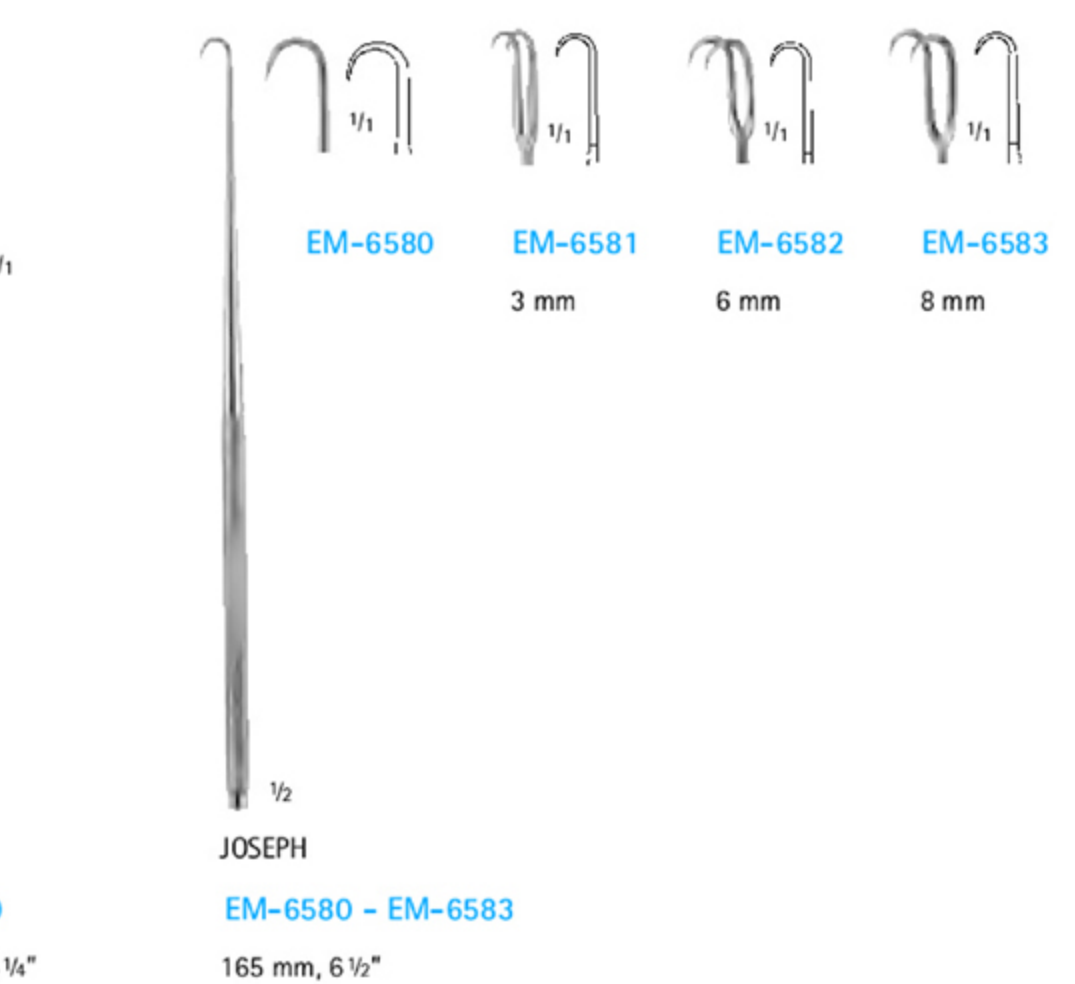

OBWEGESER
EM-6570
Chin retractor
155 mm, 6"

				
<p>FRAZIER EM-6571 130 mm, 5 1/8"</p>	<p>GILLIES EM-6572 - EM-6573 180 mm, 7"</p>	<p>GRAEFE EM-6574 - EM-6575 125 mm, 5"</p>	<p>FREER EM-6576 150 mm, 6"</p>	<p>FOMON EM-6577 145 mm, 5 3/4"</p>
				
<p>BERGMANN EM-6578 140 mm, 5 1/2"</p>	<p>KILNER EM-6579 160 mm, 6 1/4"</p>	<p>JOSEPH EM-6580 - EM-6583 165 mm, 6 1/2"</p>		



EM-6584

EM-6586

EM-6585

EM-6587

EM-6584 - EM-6587

Small curve, sharp
165 mm, 6 1/2"



EM-6588

EM-6590

EM-6589

EM-6591

EM-6588 - EM-6591

Small curve, blunt
165 mm, 6 1/2"



EM-6592

EM-6593

EM-6592 - EM-6593

160 mm, 6 1/4"

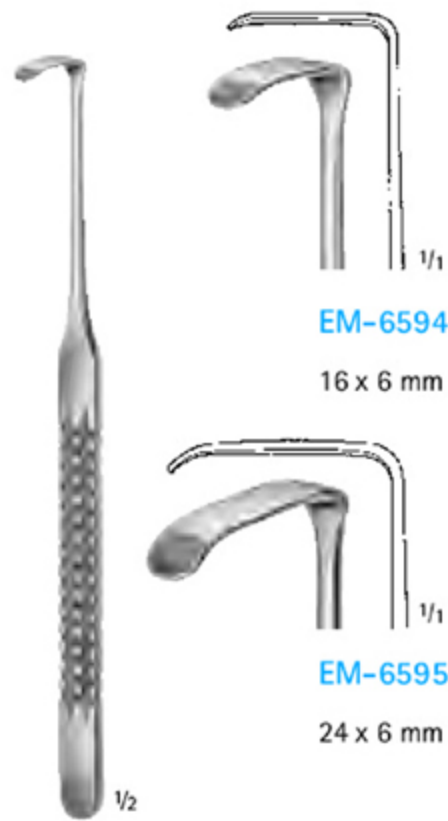

EM-6594

16 x 6 mm

EM-6595

24 x 6 mm

LANGENBECK-GREEN

EM-6594 - EM-6595

160 mm, 6 1/4"

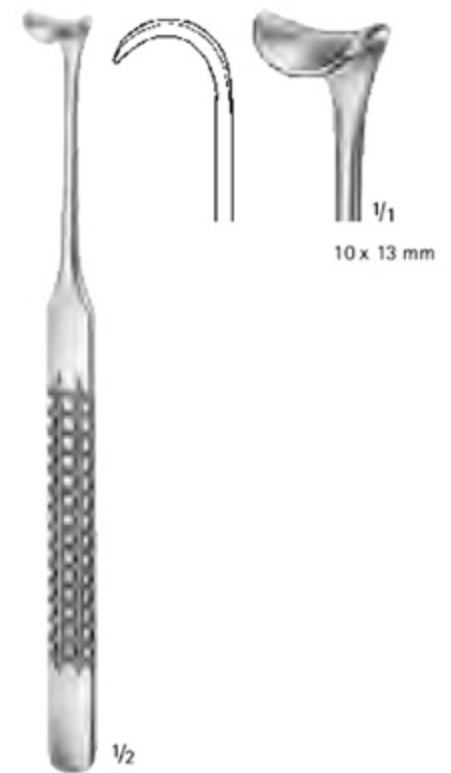

EM-6596

160 mm, 6 1/4"



EM-6597

Gauze case



LUNIATSCHEK

EM-6598

Cotton plugger
180 mm, 7"



LUNIATSCHEK, modif.

EM-6599

Cotton plugger, small
180 mm, 7"



EM-6600

Retraction thread packer,
flexible
170 mm, 6³/₄"



BÜCHS

EM-6601

Applicator for
retraction sutures
175 mm, 7"



HAUER

EM-6602

Medicine applicator
135 mm, 5 ¹/₄"



EM-6603

130 mm, 5 1/8"



EM-6604

145 mm, 5 3/4"

EM-6603 - EM-6604

Standard patterns



EM-6605

115 mm, 4 1/2"



EM-6606

130 mm, 5 1/8"

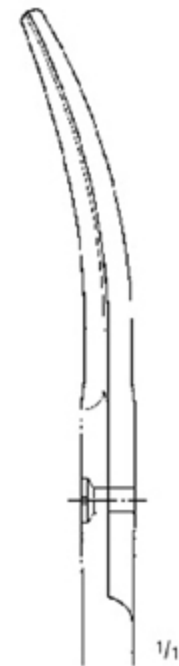

EM-6607

145 mm, 5 3/4"

COOPER

EM-6605 - EM-6607

Standard patterns



EM-6608

105 mm, 4 1/8"



EM-6609

115 mm, 4 1/2"



EM-6610

130 mm, 5 1/8"



EM-6611

145 mm, 5 3/4"

EM-6608 - EM-6611

Standard patterns



EM-6612

115 mm, 4 1/2"



EM-6613

130 mm, 5 1/8"



EM-6614

145 mm, 5 3/4"

EM-6612 - EM-6614

Standard patterns

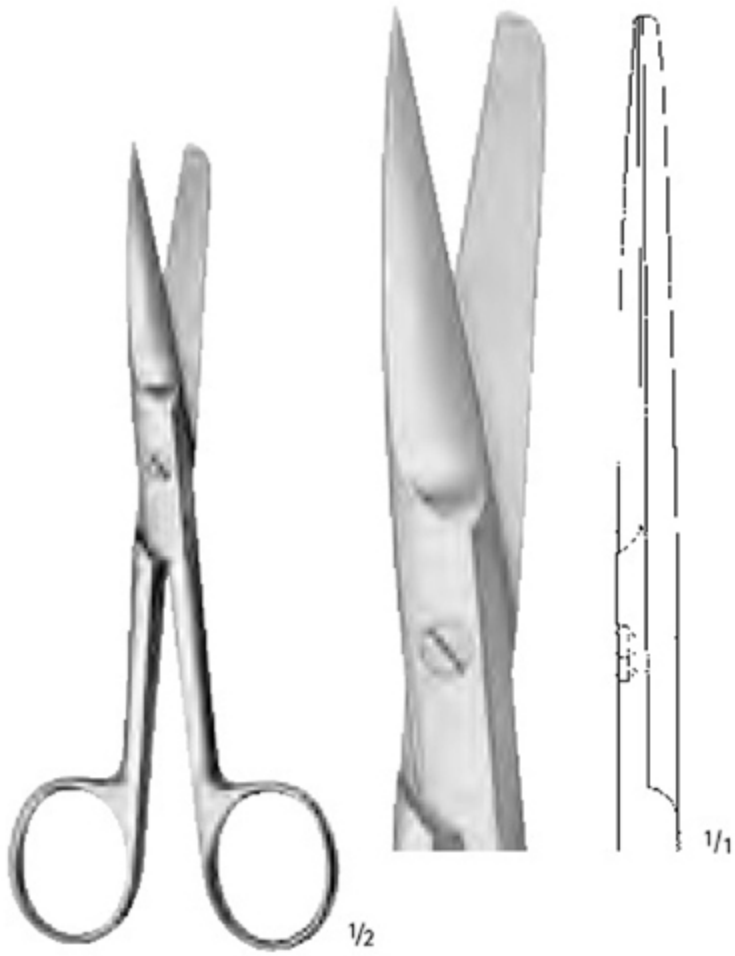

DEAVER

EM-6615

Surgical scissors with flat lock
145 mm, 5³/₄"

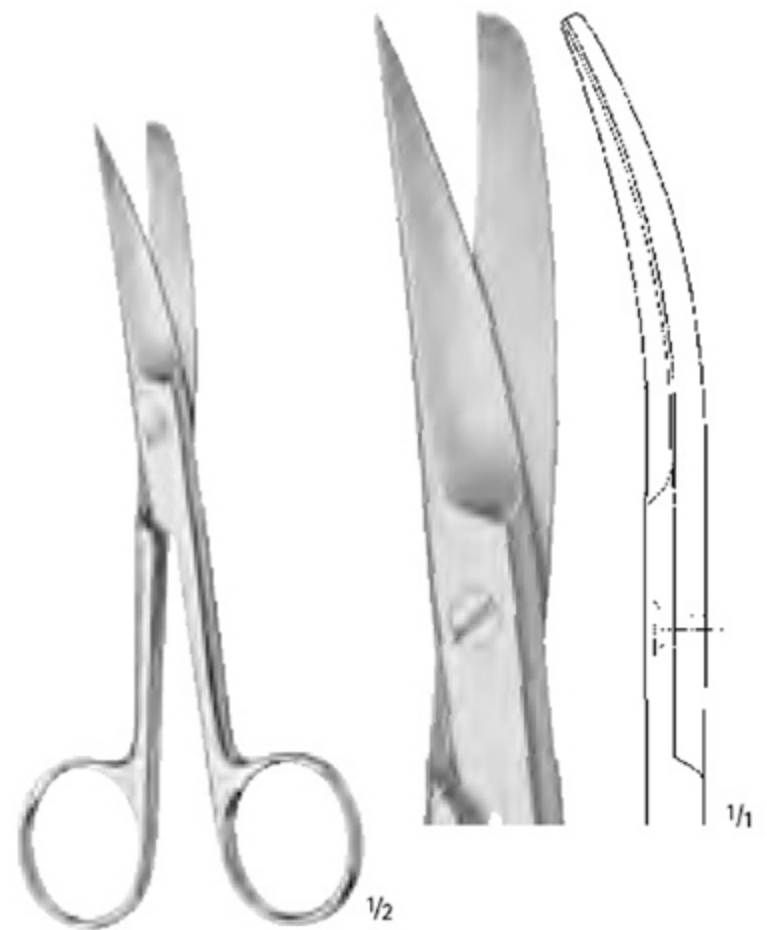

DEAVER

EM-6616

Surgical scissors with flat lock
145 mm, 5³/₄"



EM-6617

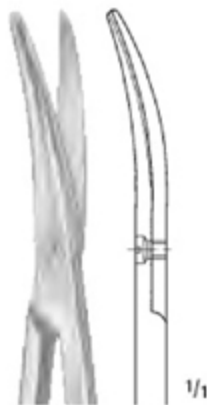

EM-6618

EM-6617 - EM-6618
Dissecting scissors
115 mm, 4 1/2"



EM-6619



EM-6620

BABY-METZENBAUM
EM-66219 - EM-6620
Dissecting scissors
145 mm, 5 3/4"



EM-6621

145 mm, 5 3/4"



EM-6622

180 mm, 7"

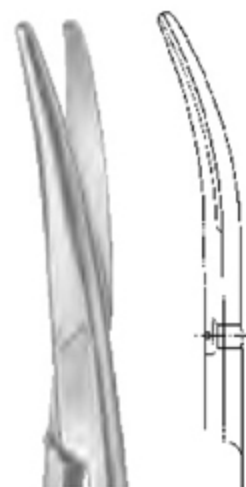

EM-6623

145 mm, 5 3/4"



EM-6624

180 mm, 7"

METZENBAUM
EM-6621 - EM-6624
Dissecting scissors

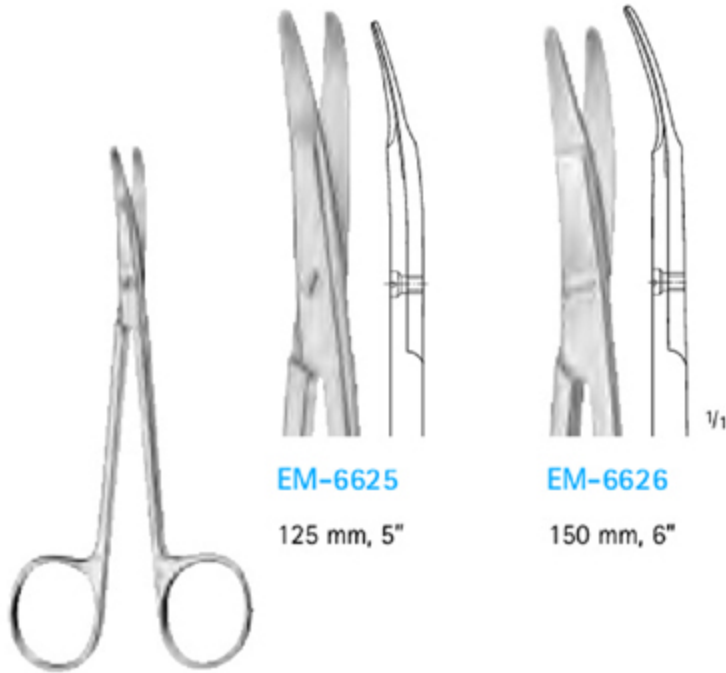

EM-6625
125 mm, 5"

EM-6626
150 mm, 6"

KILNER

EM-6625 - EM-6626

Special flat points for dissecting and undermining the skin

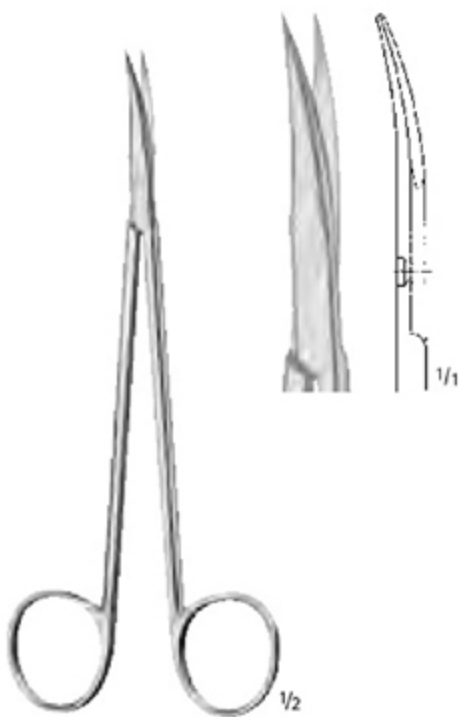

EM-6627

Blades outside semi-sharp
150 mm, 6"

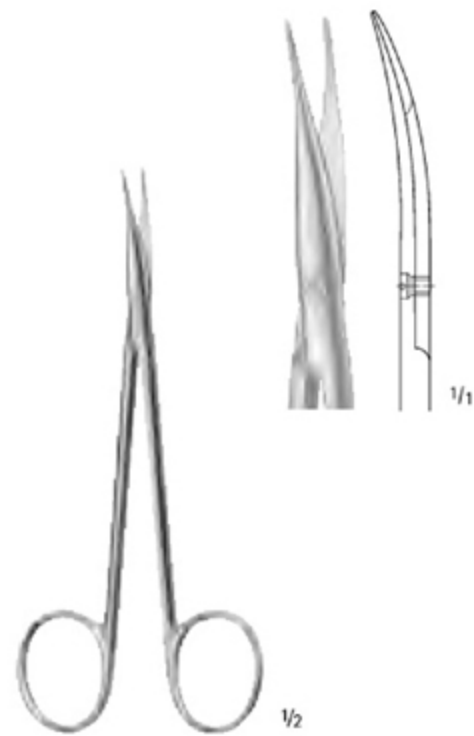

JAMESON-WERBER

EM-6628

130 mm, 5 1/8"

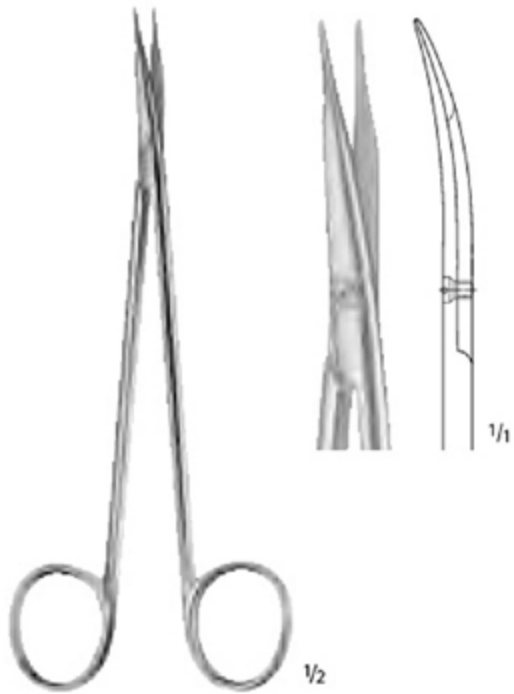

JAMESON

EM-6629

150 mm, 6"

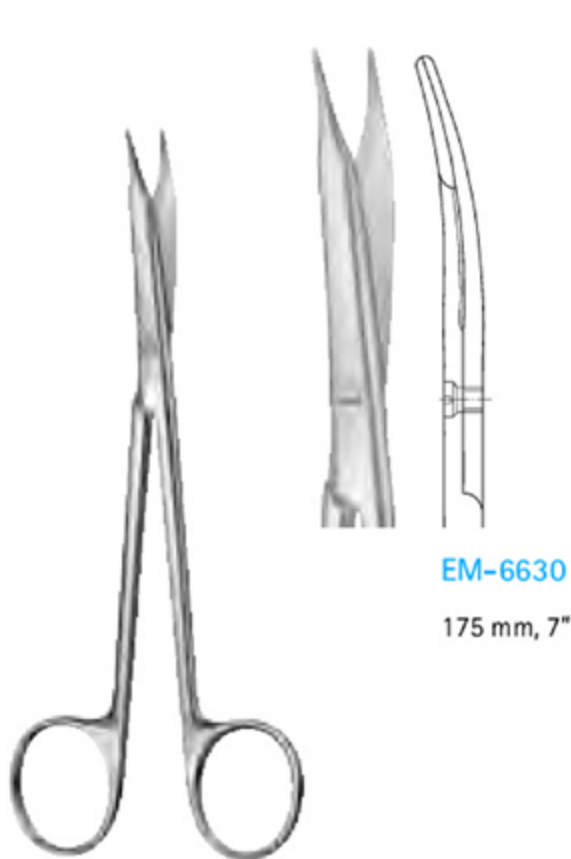

REYNOLDS

EM-6630 - EM-6631

EM-6630

175 mm, 7"

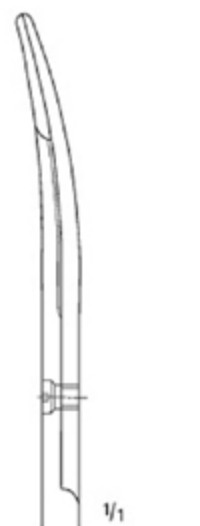

EM-6631

145 mm, 5 3/4"

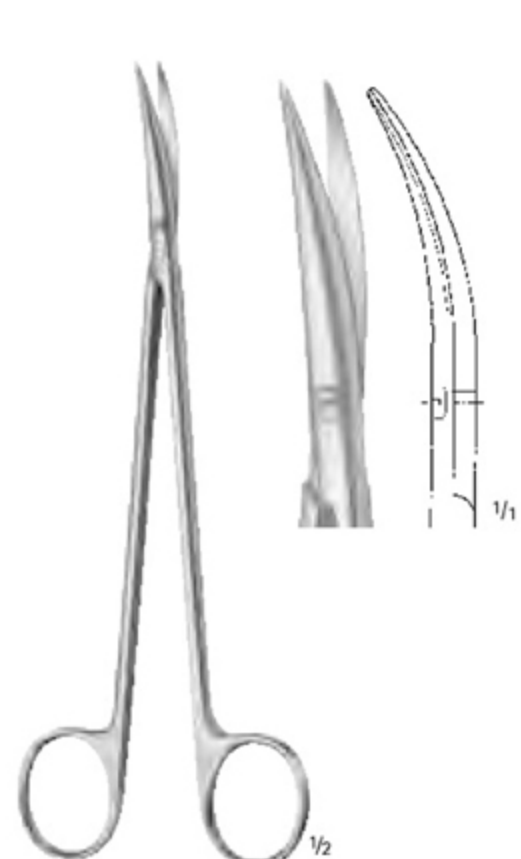

DE BAKEY

EM-6632

175 mm, 7"

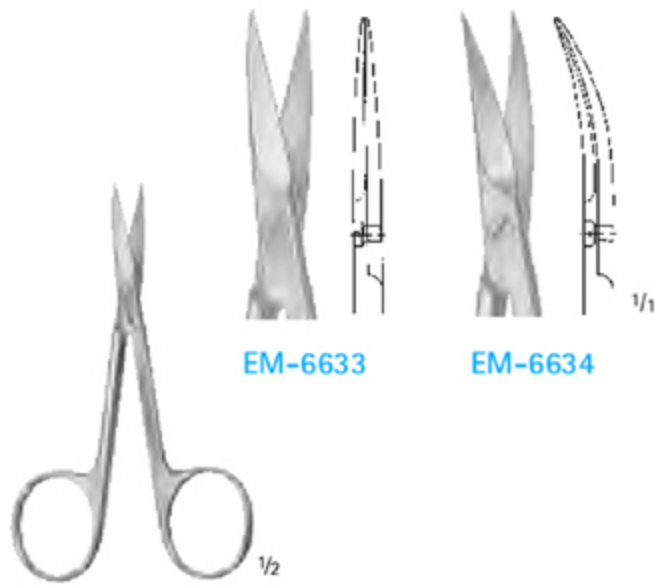

EM-6633

EM-6634

EM-6633 - EM-6634

90 mm, 3 1/2"

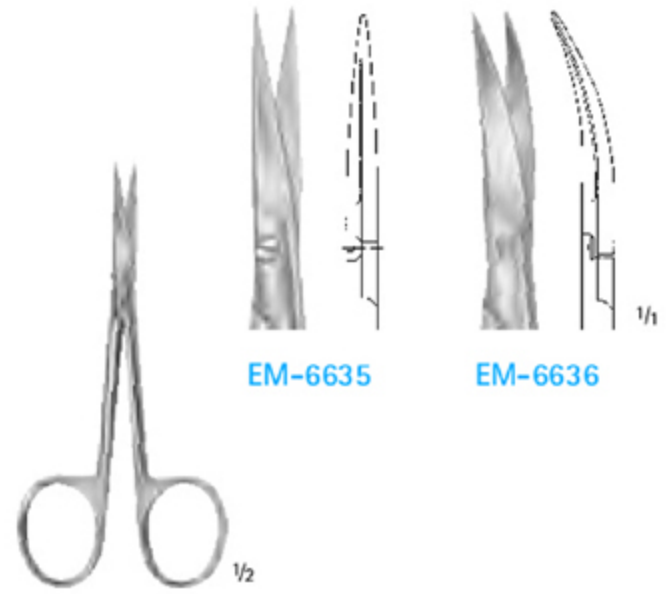

EM-6635

EM-6636

EM-6635 - EM-6636

95 mm, 3 3/4"



EM-6637

EM-6638

EM-6637 - EM-6638

105 mm, 4 1/8"

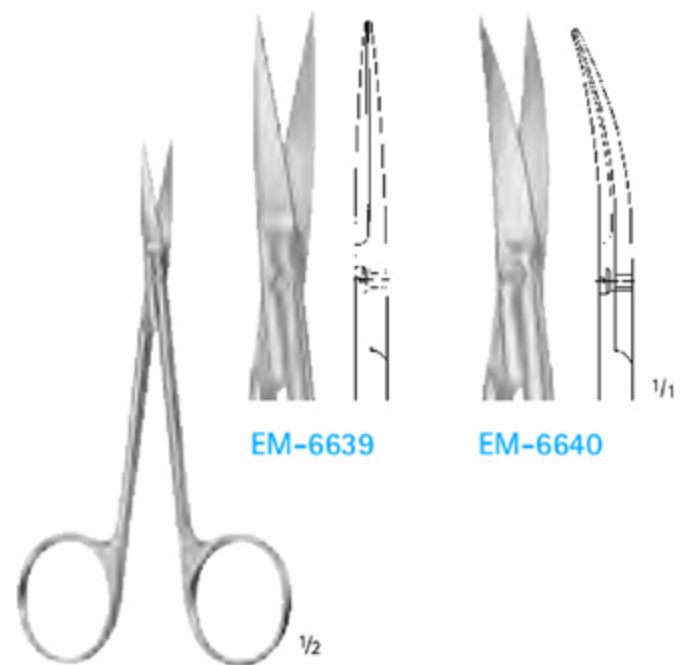

EM-6639

EM-6640

EM-6639 - EM-6640

115 mm, 4 1/2"



EM-6641



EM-6642



EM-6643



EM-6644



EM-6645

Curved to side,
especially suited to
remove ligatures

EM-6641 - EM-6645

110 mm, 4 3/8"

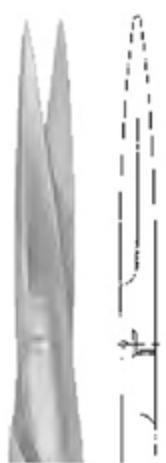

EM-6646

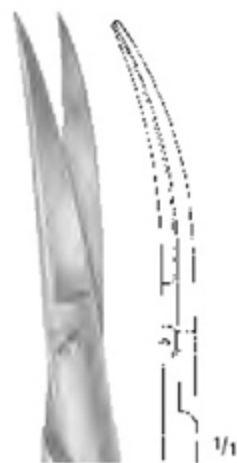

EM-6647

EM-6646 - EM-6647

120 mm, 4 3/4"

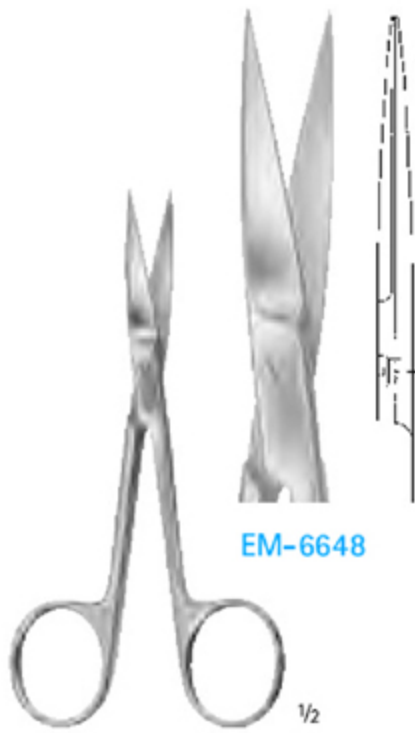

EM-6648



EM-6649

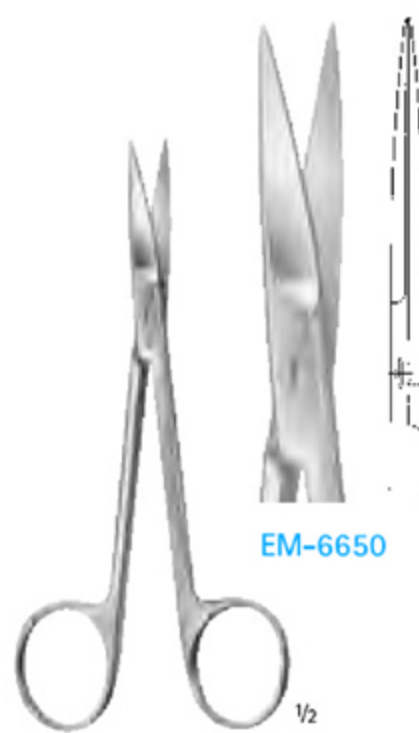

EM-6650

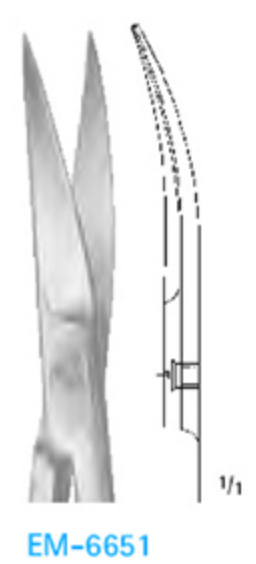

EM-6651

EM-6648 - EM-6649

120 mm, 4 3/4"

EM-6650 - EM-6651

130 mm, 5 1/8"



EM-6652

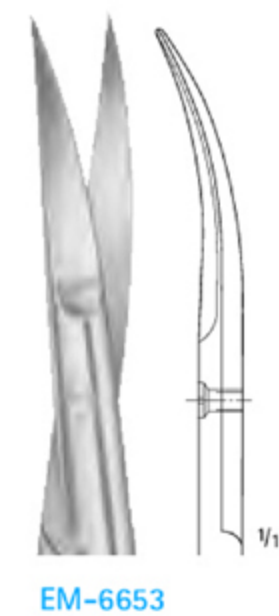

EM-6653



EM-6654

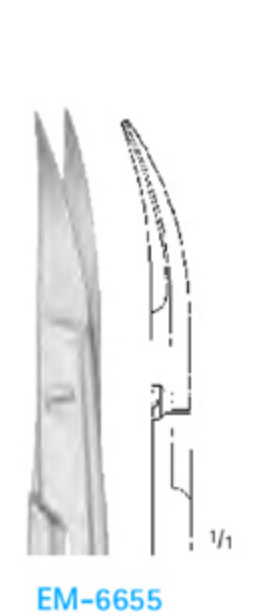

EM-6655

JOSEPH

EM-6652 - EM-6653

150 mm, 6"

KELLY

EM-6654 - EM-6655

175 mm, 7"

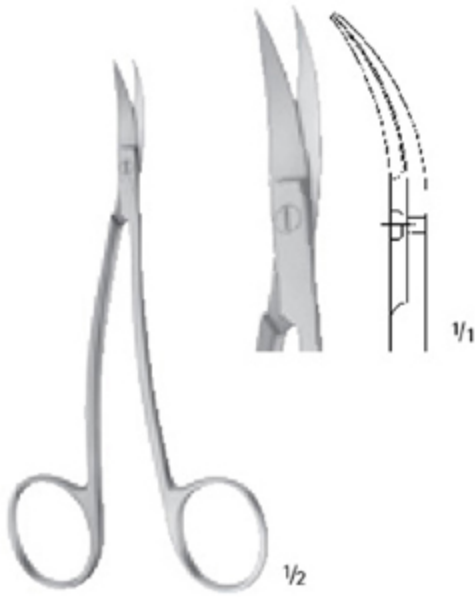

LA GRANGE

EM-6656

1 Blade toothed

110 mm, 4 3/8"

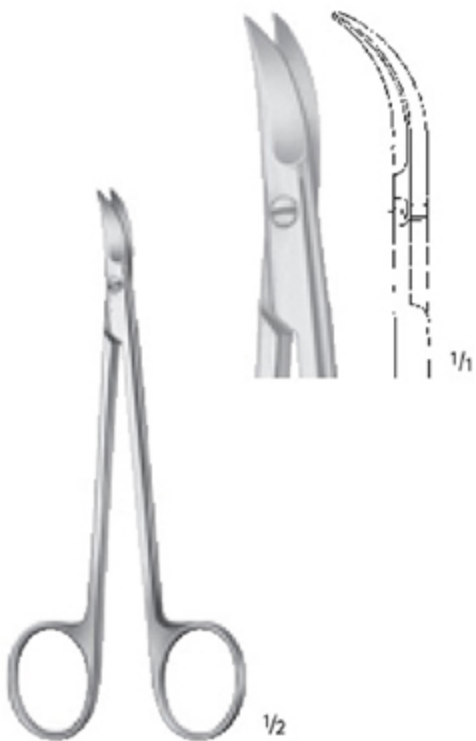

CHADWICK

EM-6657

115 mm, 4 1/2"

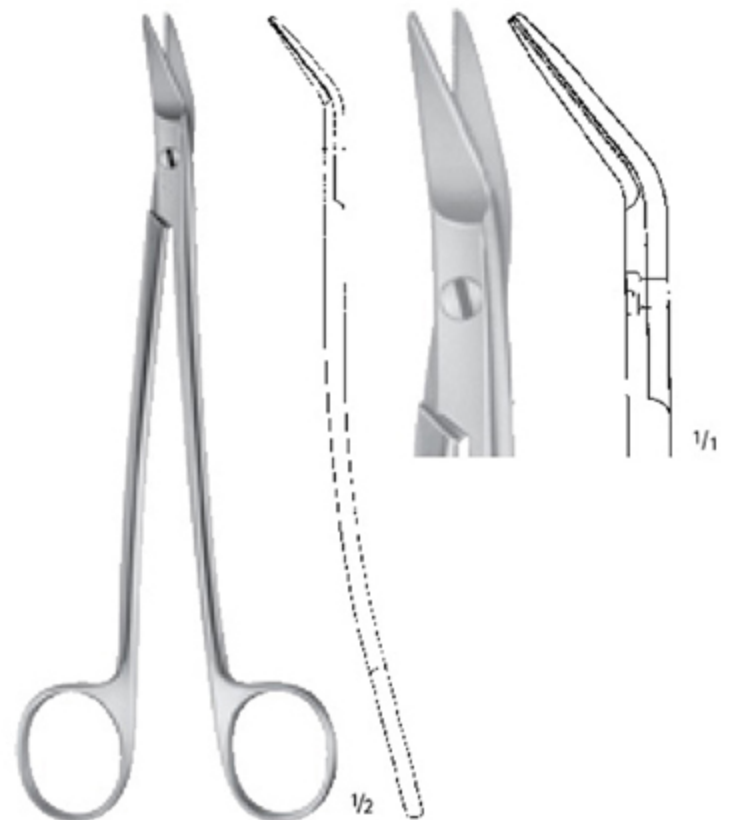

DEAN

EM-6658

Blades serrated

170 mm, 6 3/4"



EM-6659
very delicate

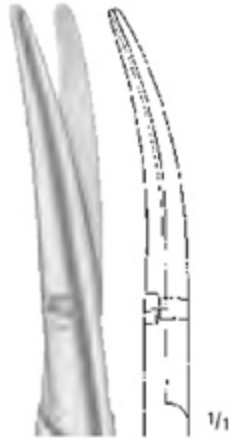

EM-6660
delicate

TOENNIS-ADSON

EM-6659 - EM-6660

175 mm, 7"

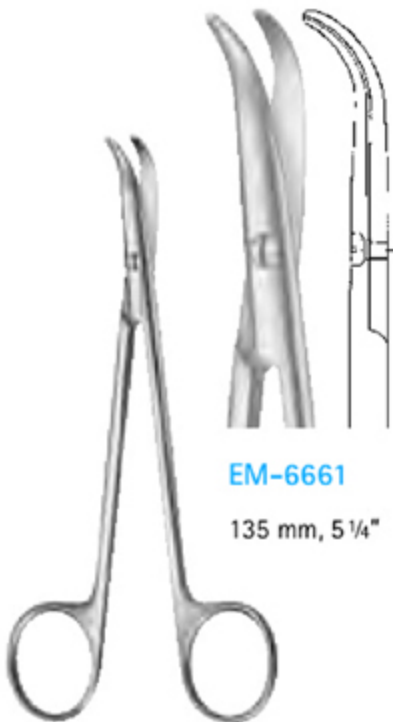

EM-6661
135 mm, 5 1/4"



EM-6662
115 mm, 4 1/2"

FOMON

EM-6661 - EM-6662

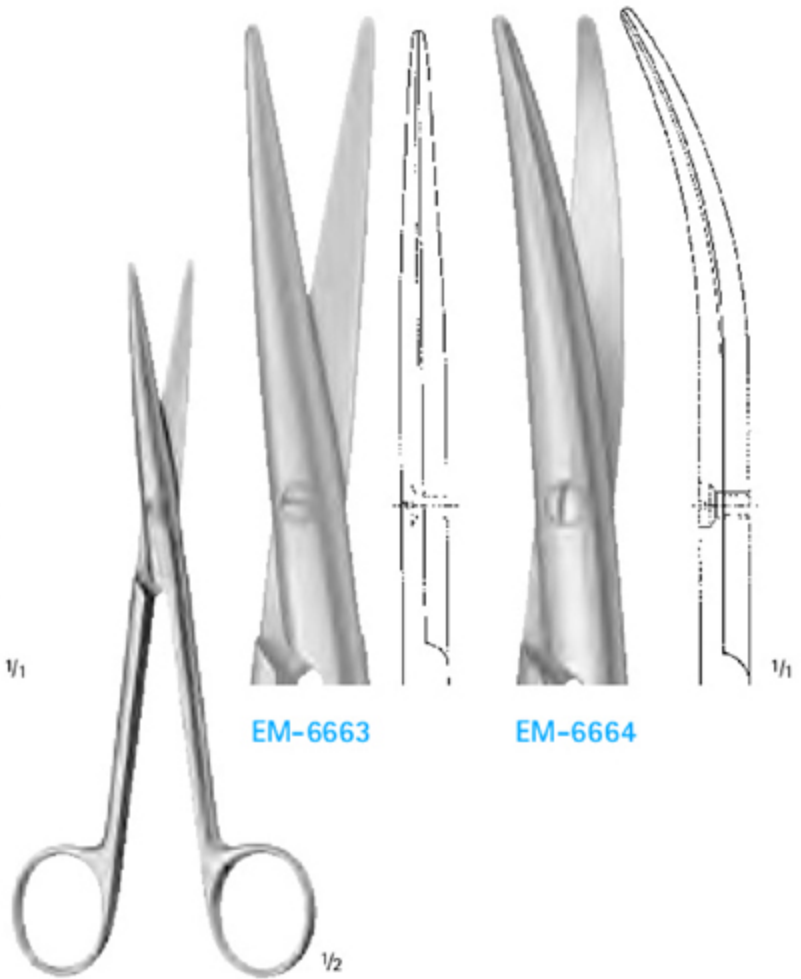

LEXER

EM-6663 - EM-6664

narrow
165 mm, 6 1/2"

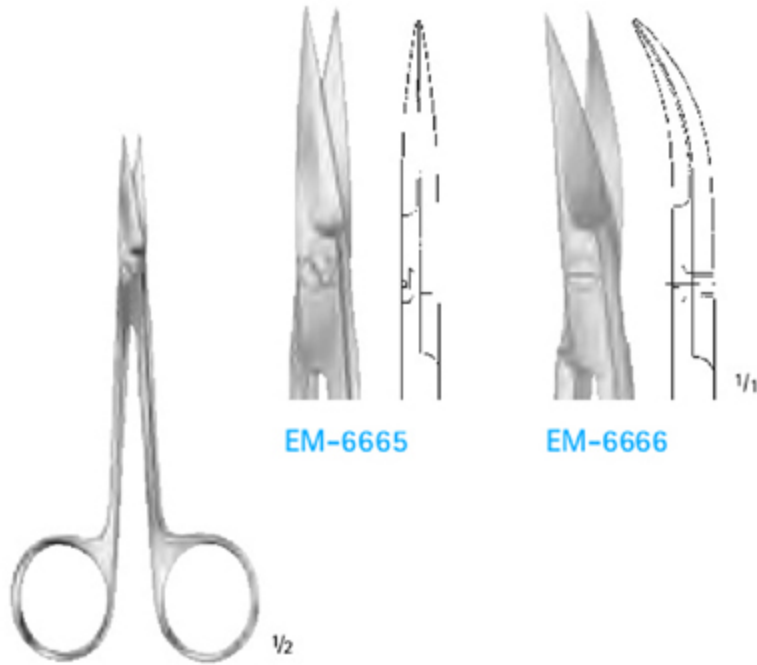

EM-6665

EM-6666

EM-6665 - EM-6666

120 mm, 4³/₄"

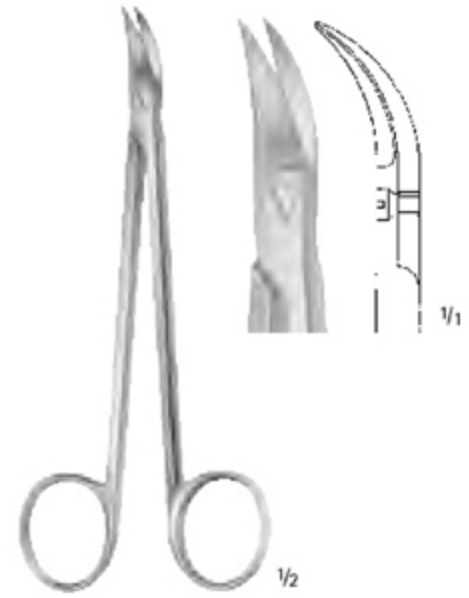

QUINBY

EM-6667

130 mm, 5¹/₈"

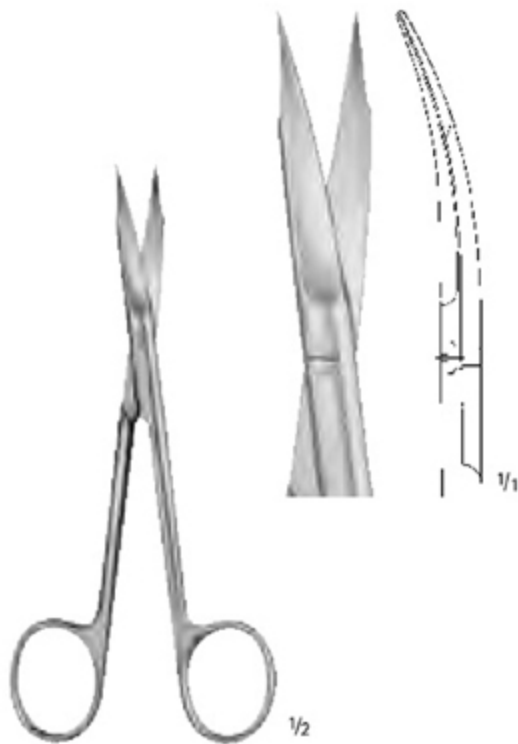

GOLDMAN-FOX

EM-6668

1 Blade toothed, fine

130 mm, 5"



LOCKLIN

EM-6669

Angled to side, 1 blade toothed

155 mm, 6"

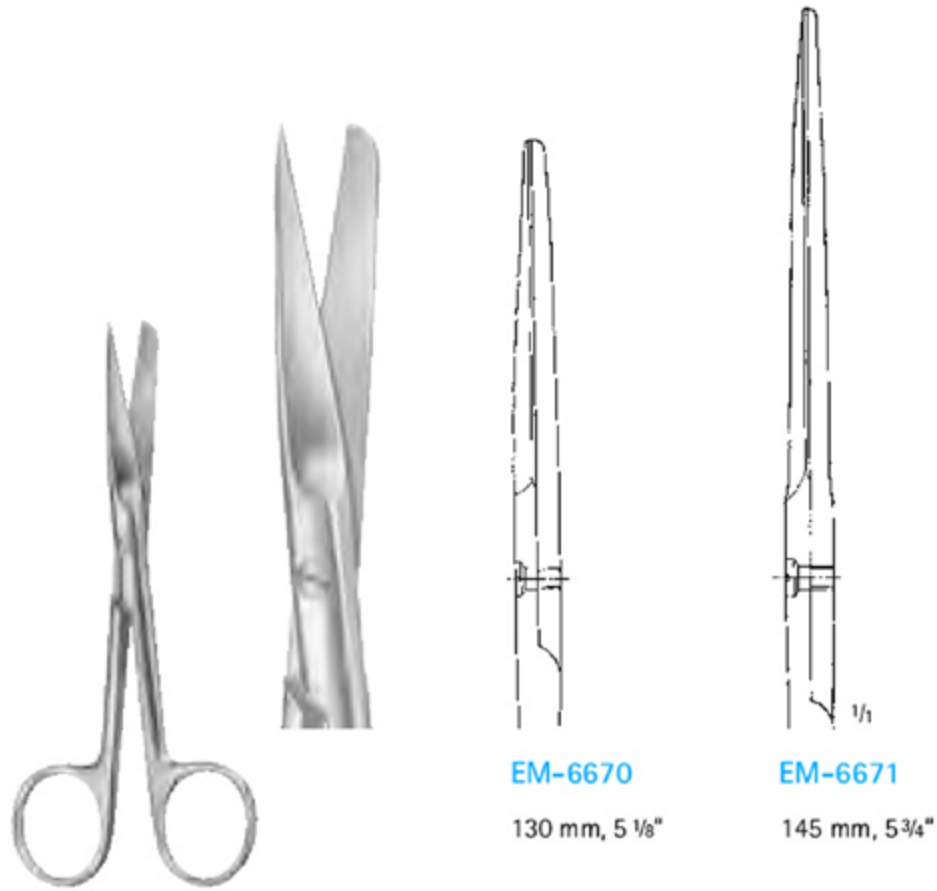

EM-6670 - EM-6671

Slender patterns

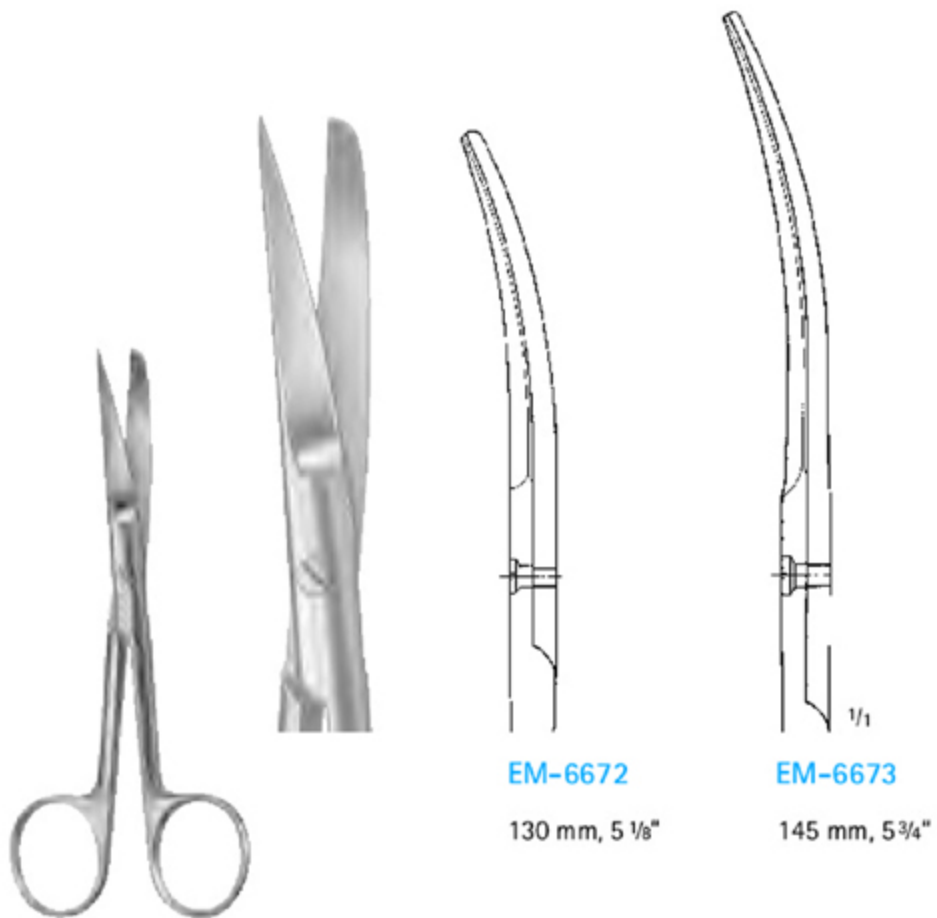

EM-6672 - EM-6673

Slender patterns

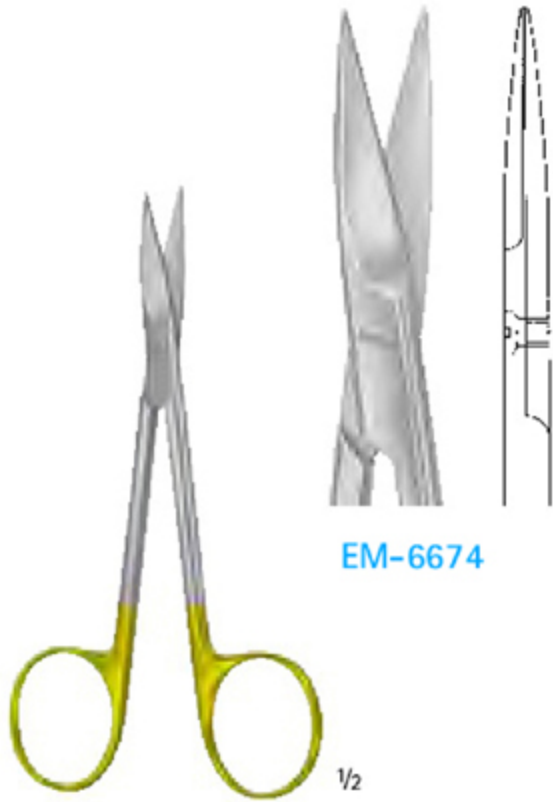

EM-6674

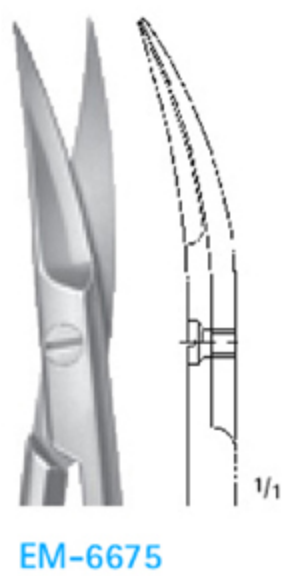

EM-6675

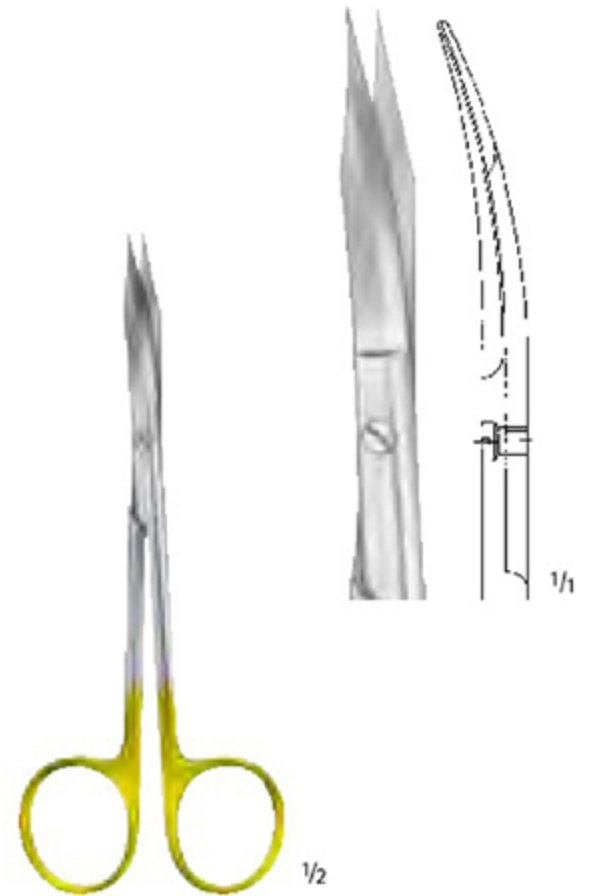

GOLDMAN-FOX

EM-6676

1 Blade serrated
130 mm, 5 1/8"

EM-6674 - EM-6675

120 mm, 4 3/4"

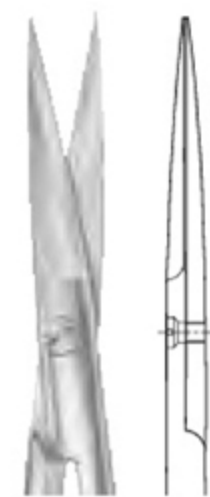

EM-6677

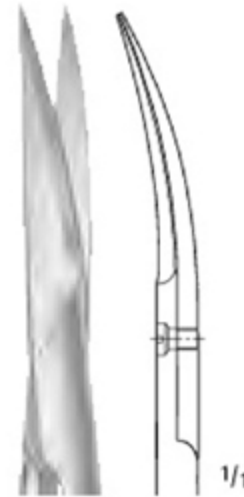

EM-6678

EM-6678W

EM-6677 - EM-6678, EM-6678W

110 mm, 4 3/8"

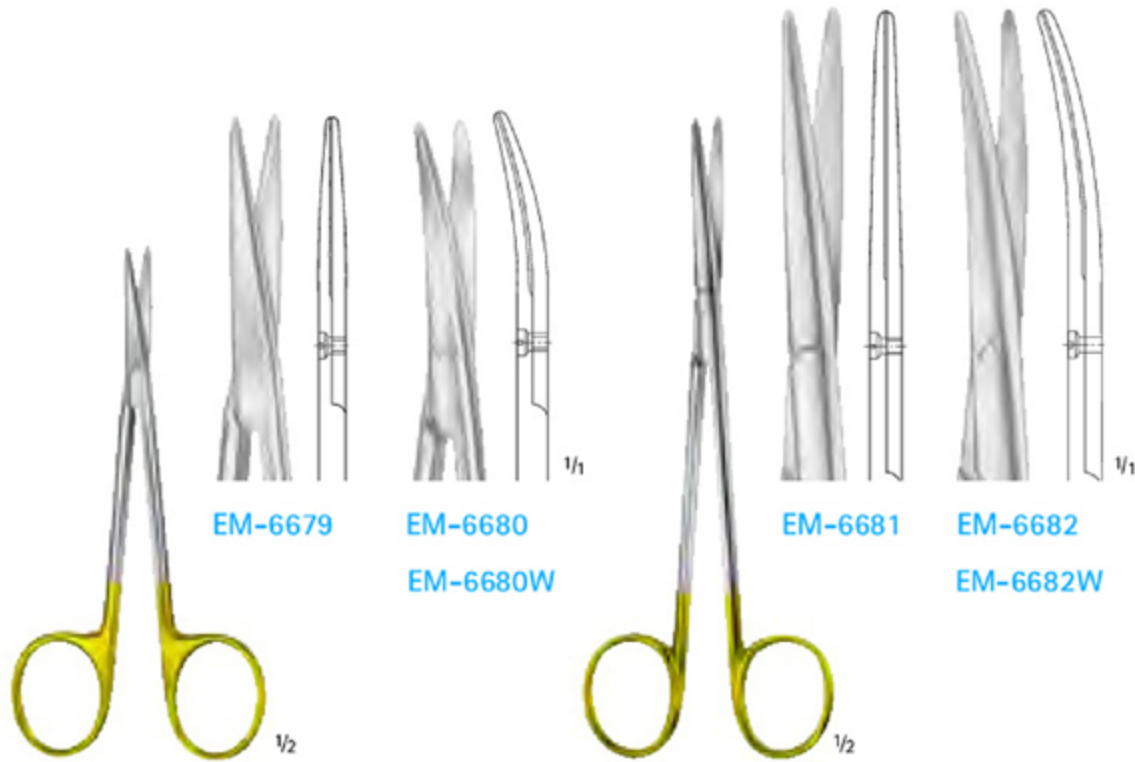

EM-6679 - EM-6680, EM-6680W
115 mm, 4 1/2"

BABY-METZENBAUM
EM-6681 - EM-6682, EM-6682W
145 mm, 5 3/4"

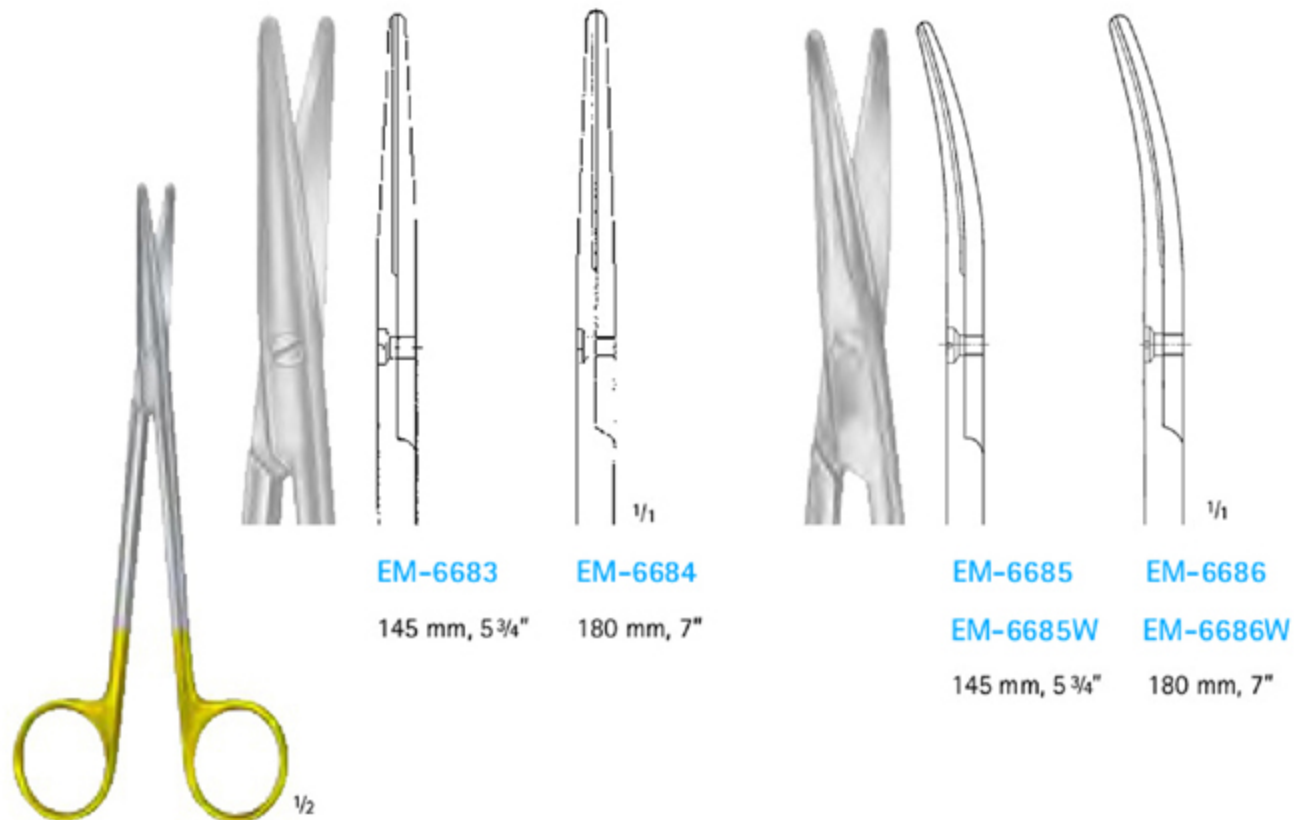

METZENBAUM
EM-6683 - EM-6686
EM-6685W, EM-6686W

EM-6683
145 mm, 5 3/4"

EM-6684
180 mm, 7"

EM-6685
EM-6685W
145 mm, 5 3/4"

EM-6686
EM-6686W
180 mm, 7"

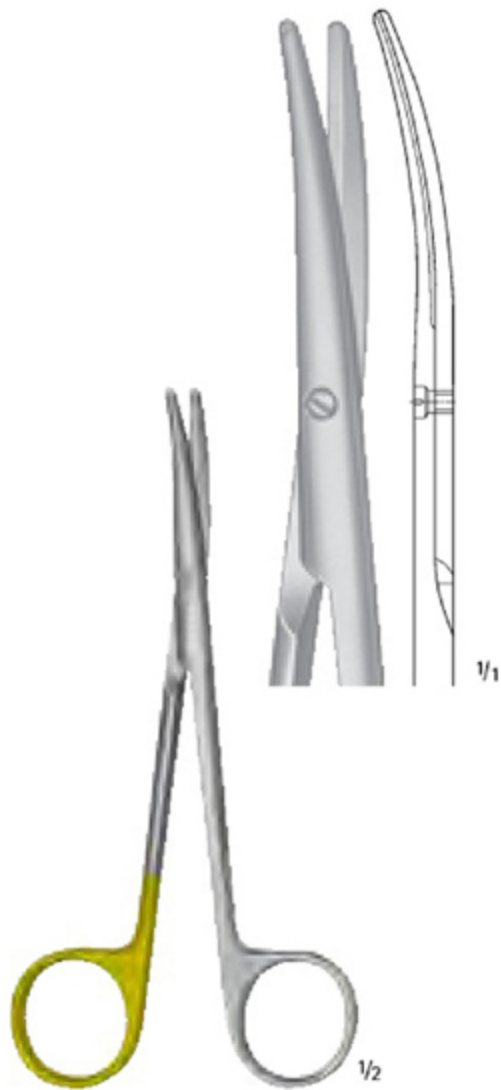

EM-6687

Ligature scissors

145 mm, 5 3/4"

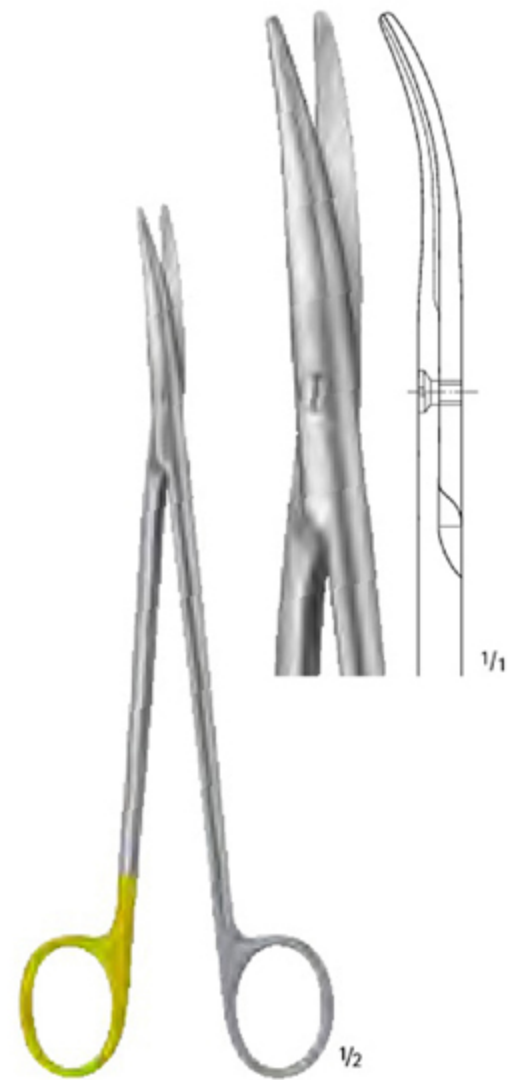

EM-6688

Ligature scissors

180 mm, 7"



EM-6689



BABY-METZENBAUM

EM-6690

145 mm, 5 3/4"



METZENBAUM

EM-6691

145 mm, 5 3/4"



METZENBAUM

EM-6692 - EM-6693

180 mm, 7"



EM-6692

EM-6693



METZENBAUM

EM-6694 - EM-6695

200 mm, 8"

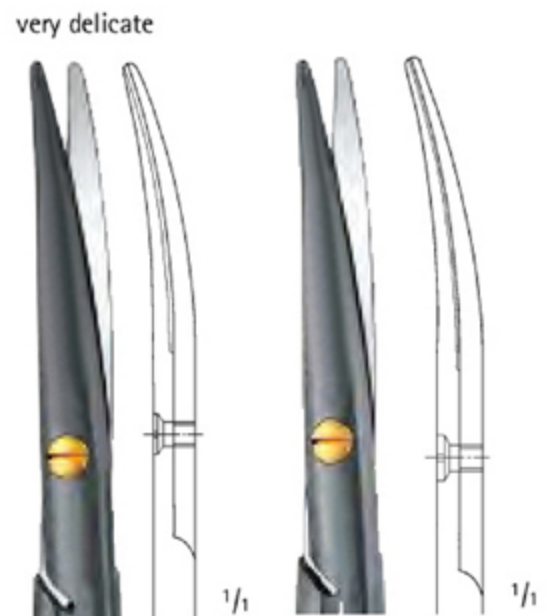

EM-6694

EM-6695



METZENBAUM

EM-6696

115 mm, 4 1/2"



BABY-METZENBAUM

EM-6697

145 mm, 5 3/4"

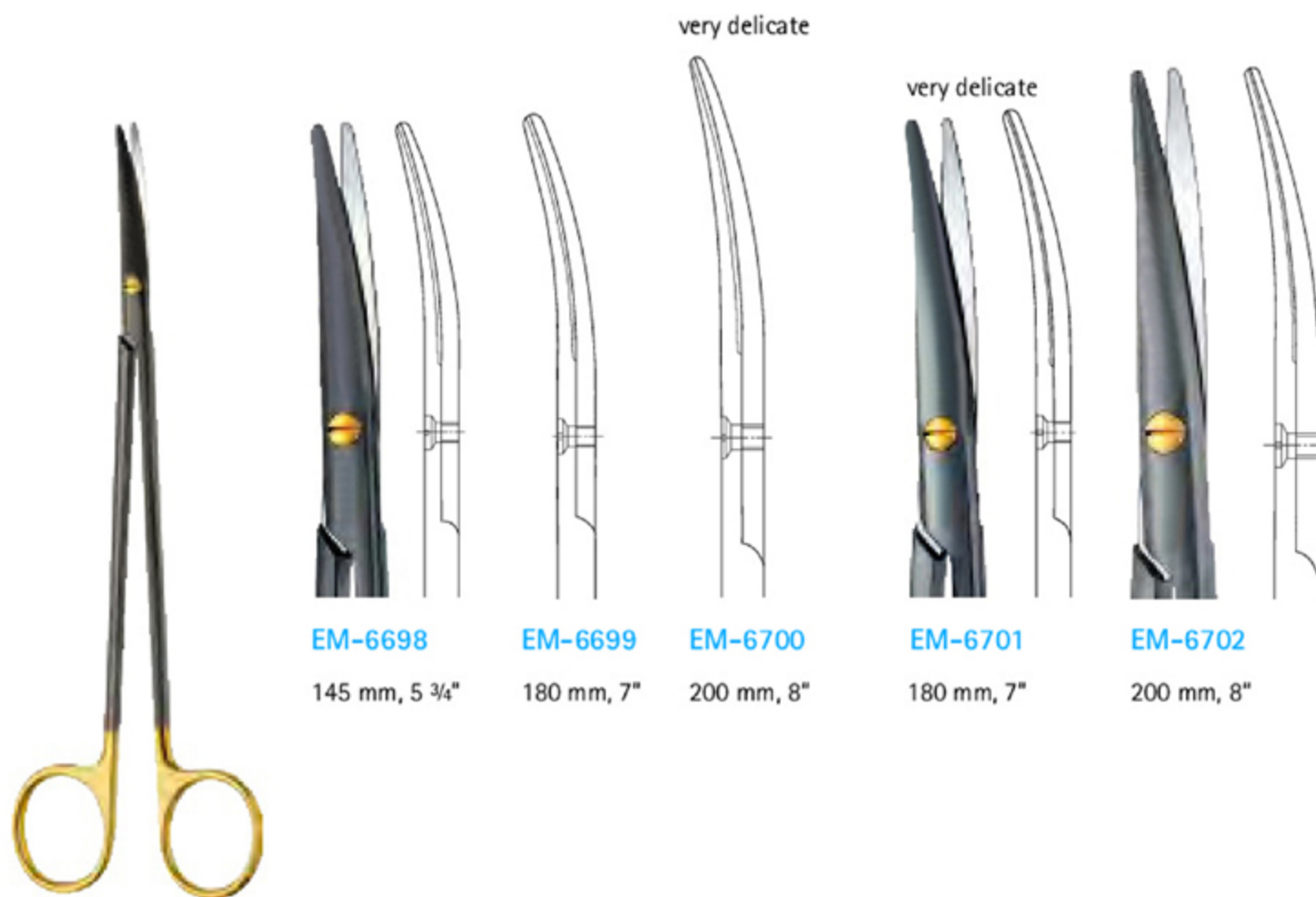

METZENBAUM

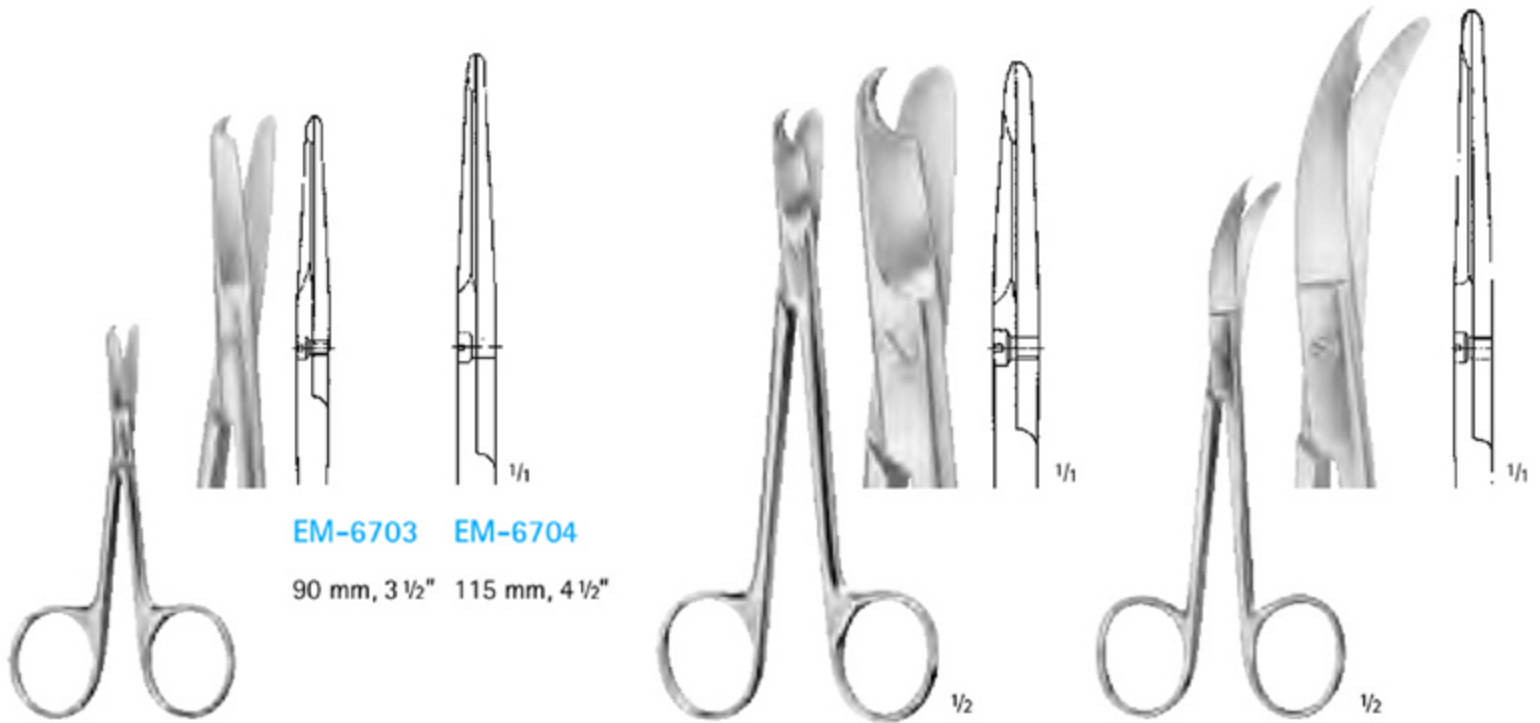

SPENCER

EM-6703 - EM-6704

Ligature scissors

LITTAUER

EM-6705

Ligature scissors
135 mm, 5 1/4"

NORTHBENT

EM-6706

Ligature scissors
120 mm, 4 3/4"

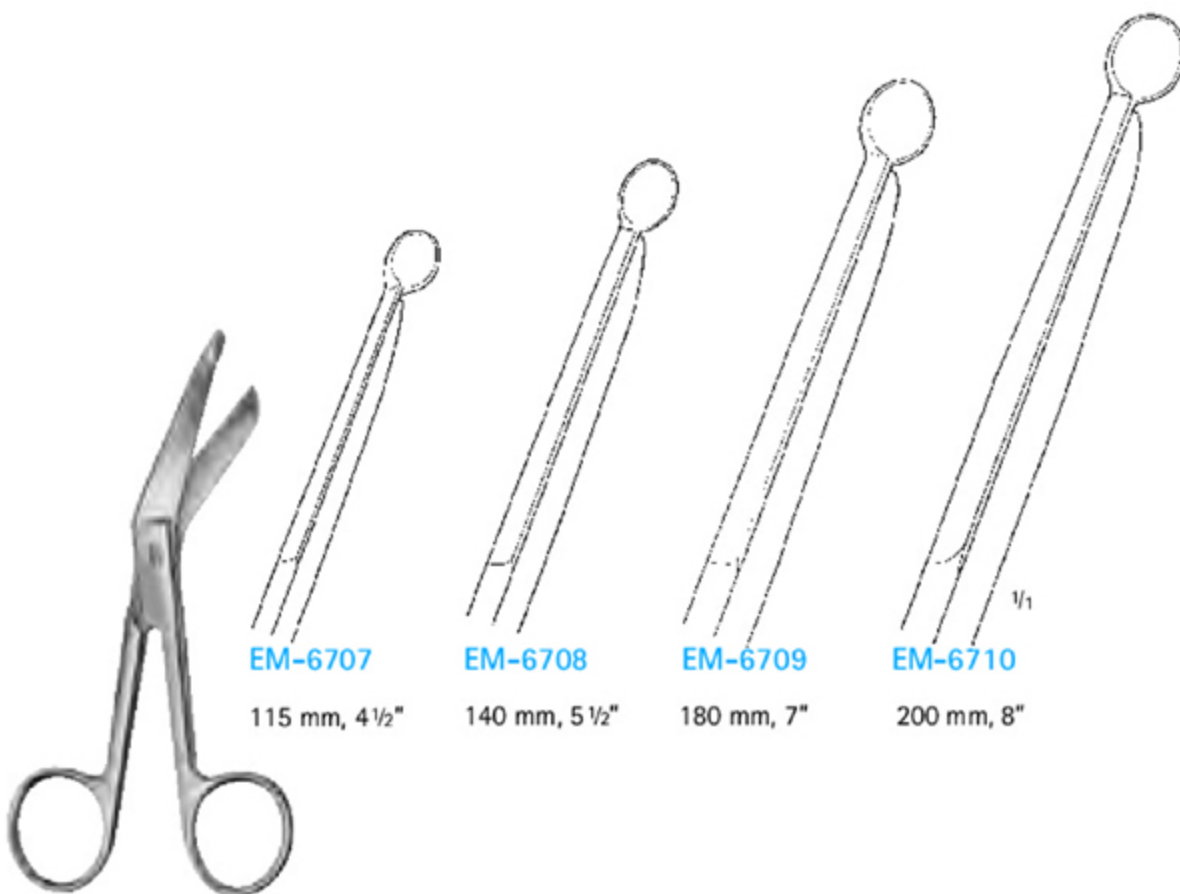

LISTER

EM-6707 - EM-6710

Bandage and cloth scissors

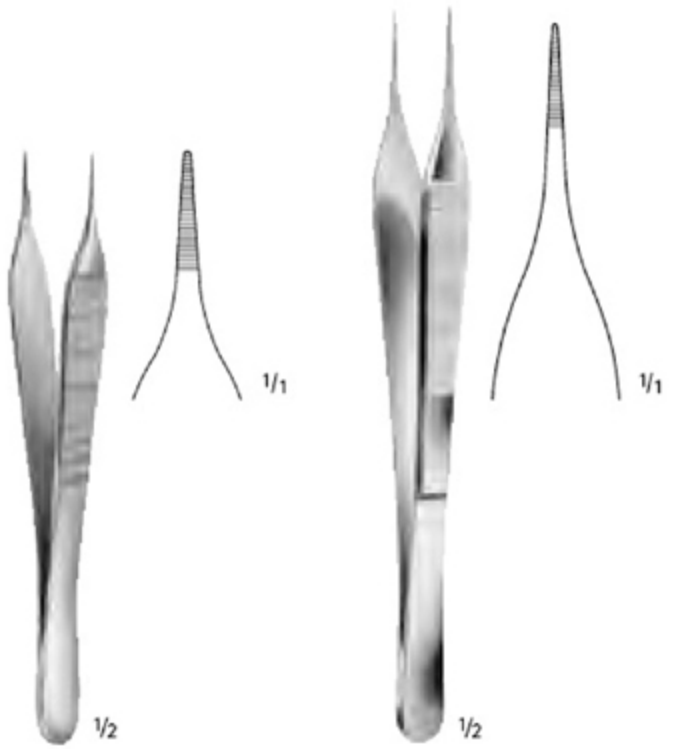

MICRO-ADSON

EM-6711

120 mm, 4 3/4"

MICRO-ADSON

EM-6712

150 mm, 6"

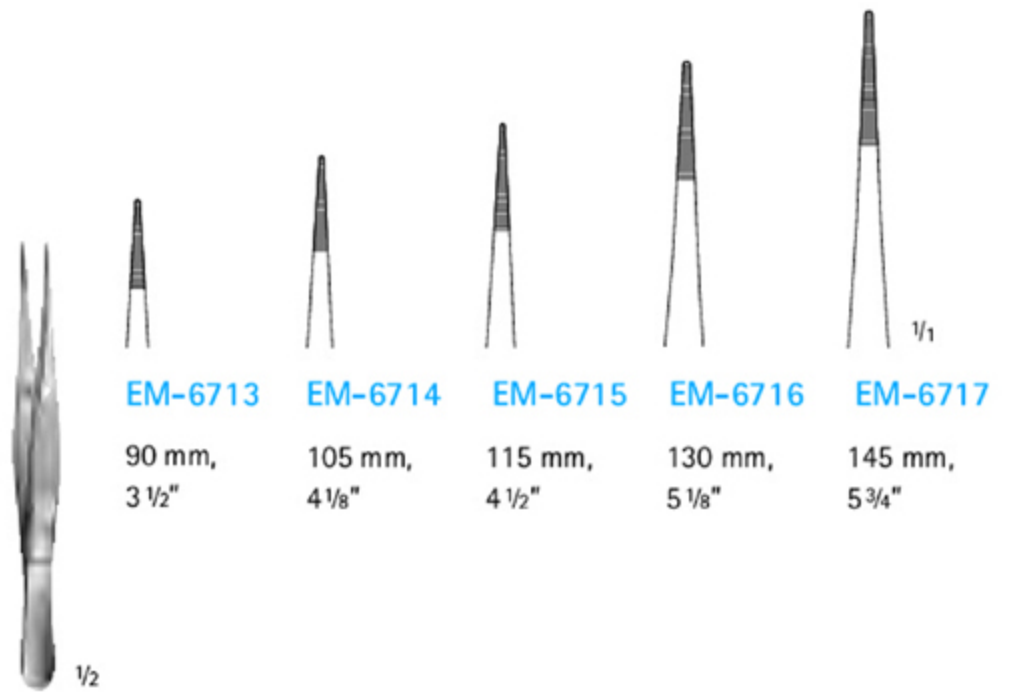

EM-6713

90 mm,
3 1/2"

EM-6714

105 mm,
4 1/8"

EM-6715

115 mm,
4 1/2"

EM-6716

130 mm,
5 1/8"

EM-6717

145 mm,
5 3/4"

EM-6713 - EM-6717

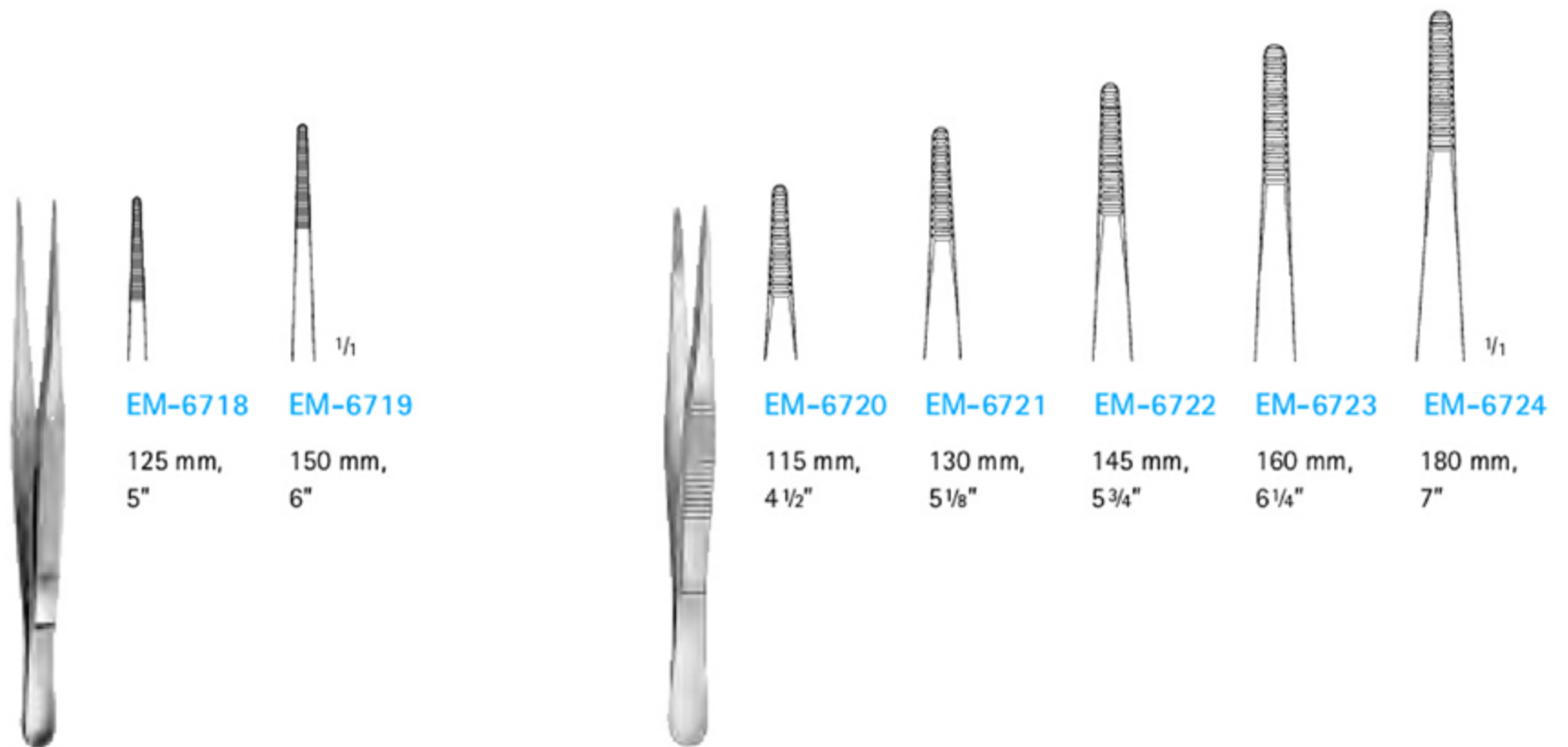

SEMKEN

EM-6718 - EM-6719

EM-6718

125 mm,
5"

EM-6719

150 mm,
6"

EM-6720

115 mm,
4 1/2"

EM-6721

130 mm,
5 1/8"

EM-6722

145 mm,
5 3/4"

EM-6723

160 mm,
6 1/4"

EM-6724

180 mm,
7"

EM-6720 - EM-6724

medium

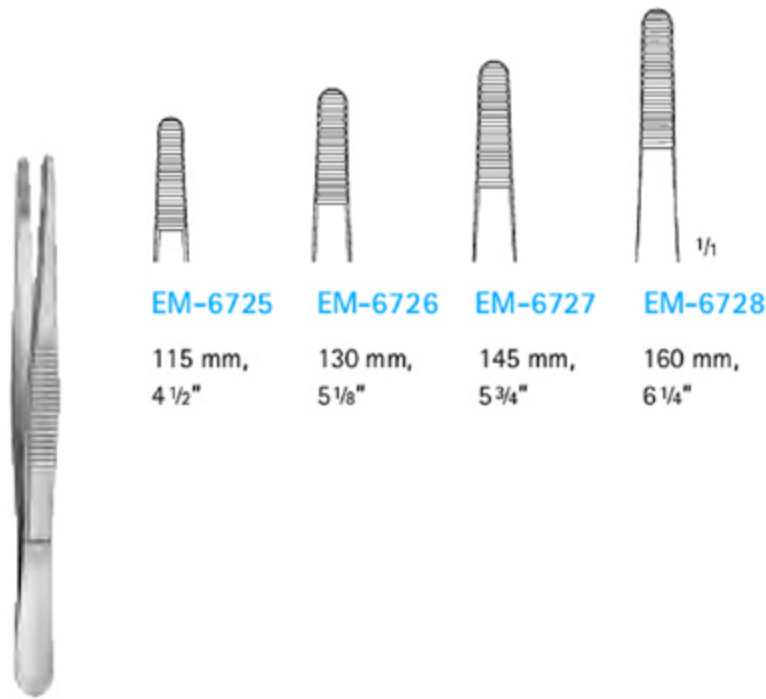

EM-6725 115 mm, 4 1/2"
EM-6726 130 mm, 5 1/8"
EM-6727 145 mm, 5 3/4"
EM-6728 160 mm, 6 1/4"

STANDARD

EM-6725 - EM-6728

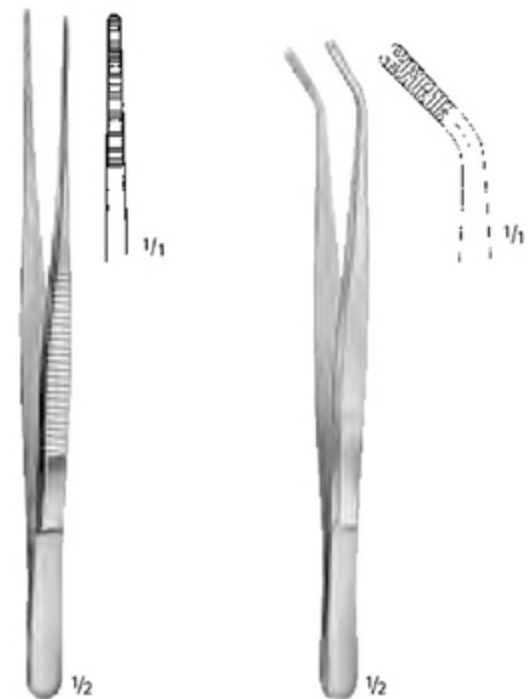

EM-6729
 155 mm, 6"

EM-6730
 Suture forceps, angulated
 150 mm, 6"

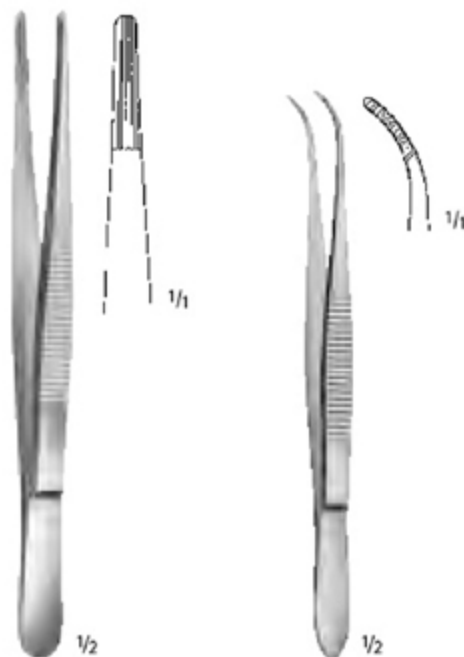

EM-6731
 OCHSNER
 Ligature forceps
 145 mm, 5 3/4"

EM-6732
 PERRY
 130 mm, 5 1/8"

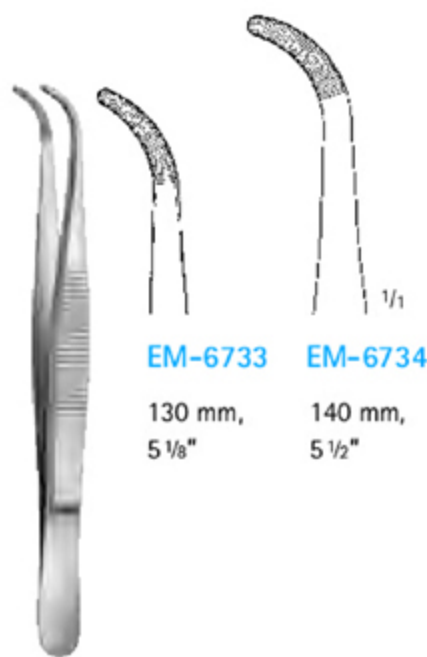

EM-6733 - EM-6734
 130 mm, 5 1/8"
 140 mm, 5 1/2"
 medium

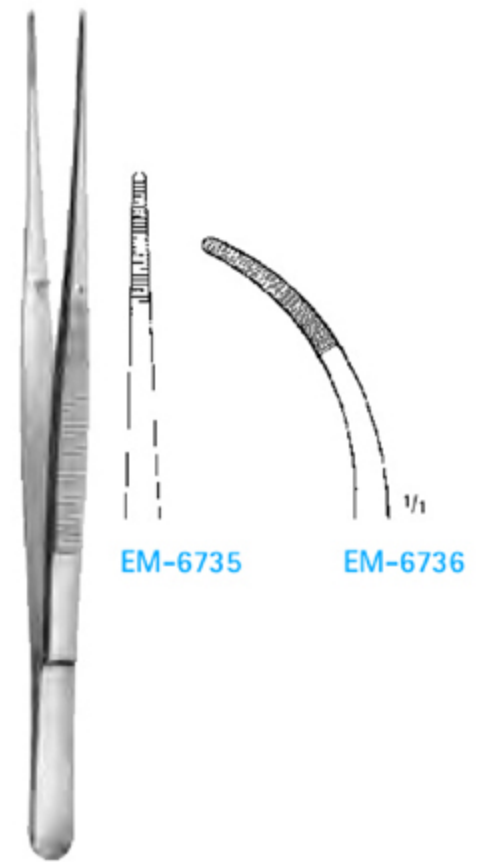

EM-6735 - EM-6736
 BROPHY
 200 mm, 8"

Toothing DE BAKEY



1.5 mm
EM-6737
150 mm,
6"



1.5 mm
 $\frac{1}{1}$
EM-6738
200 mm,
8"



2 mm
 $\frac{1}{2}$
EM-6739
150 mm,
6"

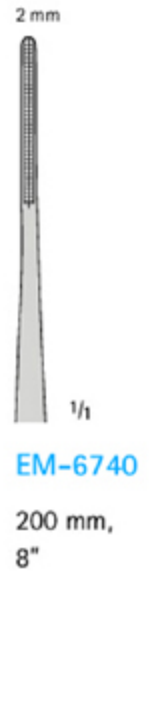

2 mm
 $\frac{1}{1}$
EM-6740
200 mm,
8"

DE BAKEY
EM-6737 - EM-6738

DE BAKEY
EM-6739 - EM-6740

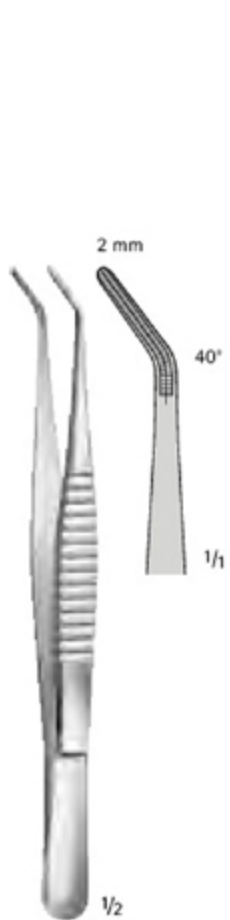

2 mm
40°
 $\frac{1}{1}$
 $\frac{1}{2}$
DE BAKEY
EM-6741
150 mm, 6"

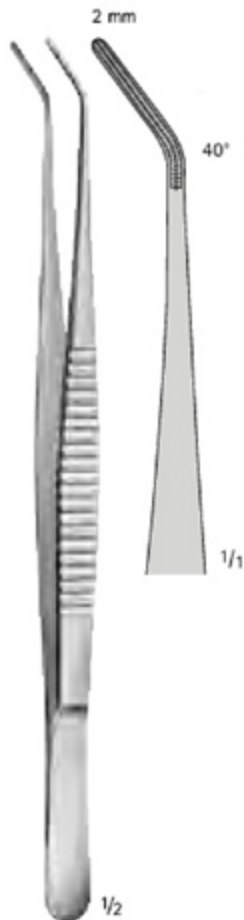

2 mm
40°
 $\frac{1}{1}$
 $\frac{1}{2}$
DE BAKEY
EM-6742
200 mm, 8"



$\frac{2}{3}$
ERGOPLANT
EM-6743
120 mm, 4 $\frac{3}{4}$ "



$\frac{2}{3}$
ERGOPLANT
EM-6744
For soft tissue
140 mm, 5 $\frac{1}{2}$ "

- Precisely worked out fine structure of carbide inserts
- thus firm and non-traumatic gripping of tissue
- universal in use
- long working life

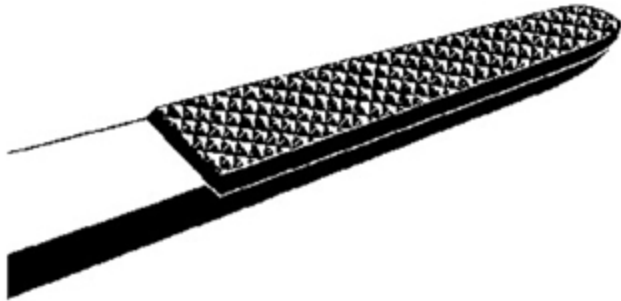

Dissecting Forceps with carbide inserts
Identification: gold-plated end



ERGOPANT

EM-6745

120 mm, 4 3/4"



ADSON

EM-6746

120 mm, 4 3/4"

For secure grasping of
matrices and interdental
wedges



STANDARD

EM-6747

145 mm, 5 3/4"



EM-6748 - EM-6750

EM-6748
145 mm,
5 3/4"



EM-6749
180 mm,
7"



EM-6750
200 mm,
8"



CUSHING

EM-6751

180 mm, 7"



EM-6752

150 mm, 6"



4. Chirurgie • Surgery

Non-Traumatic Dissecting Forceps

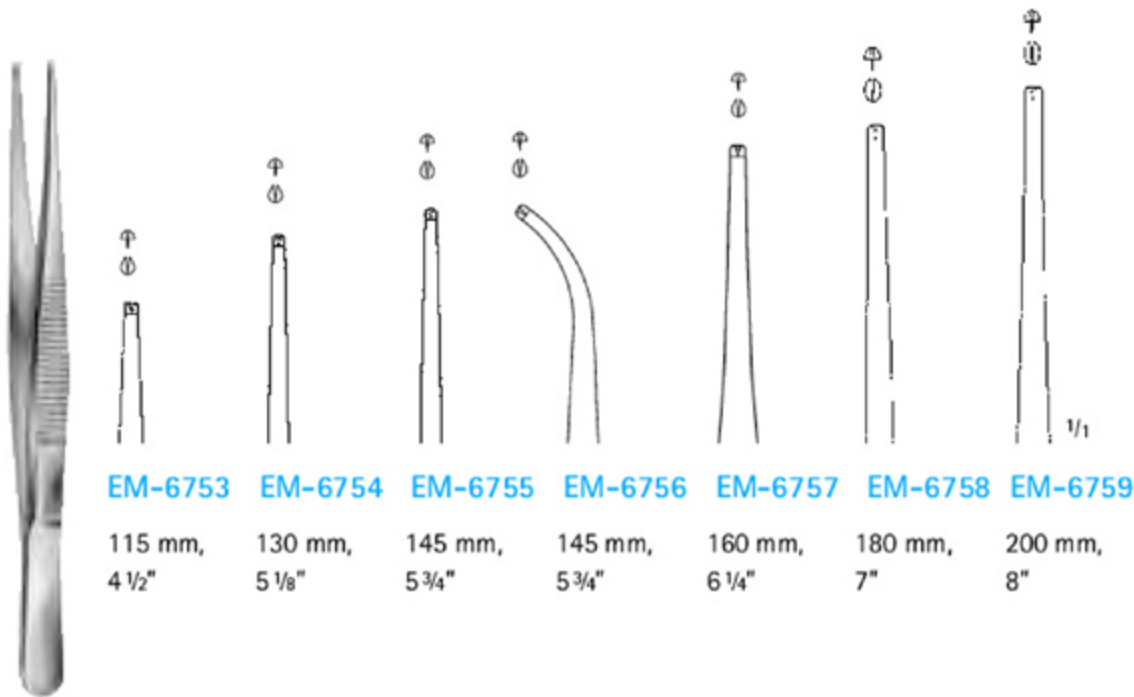

EM-6753 - EM-6759

medium

Stronger as BD537R and
BD539R but finer than
BD557R and BD559R

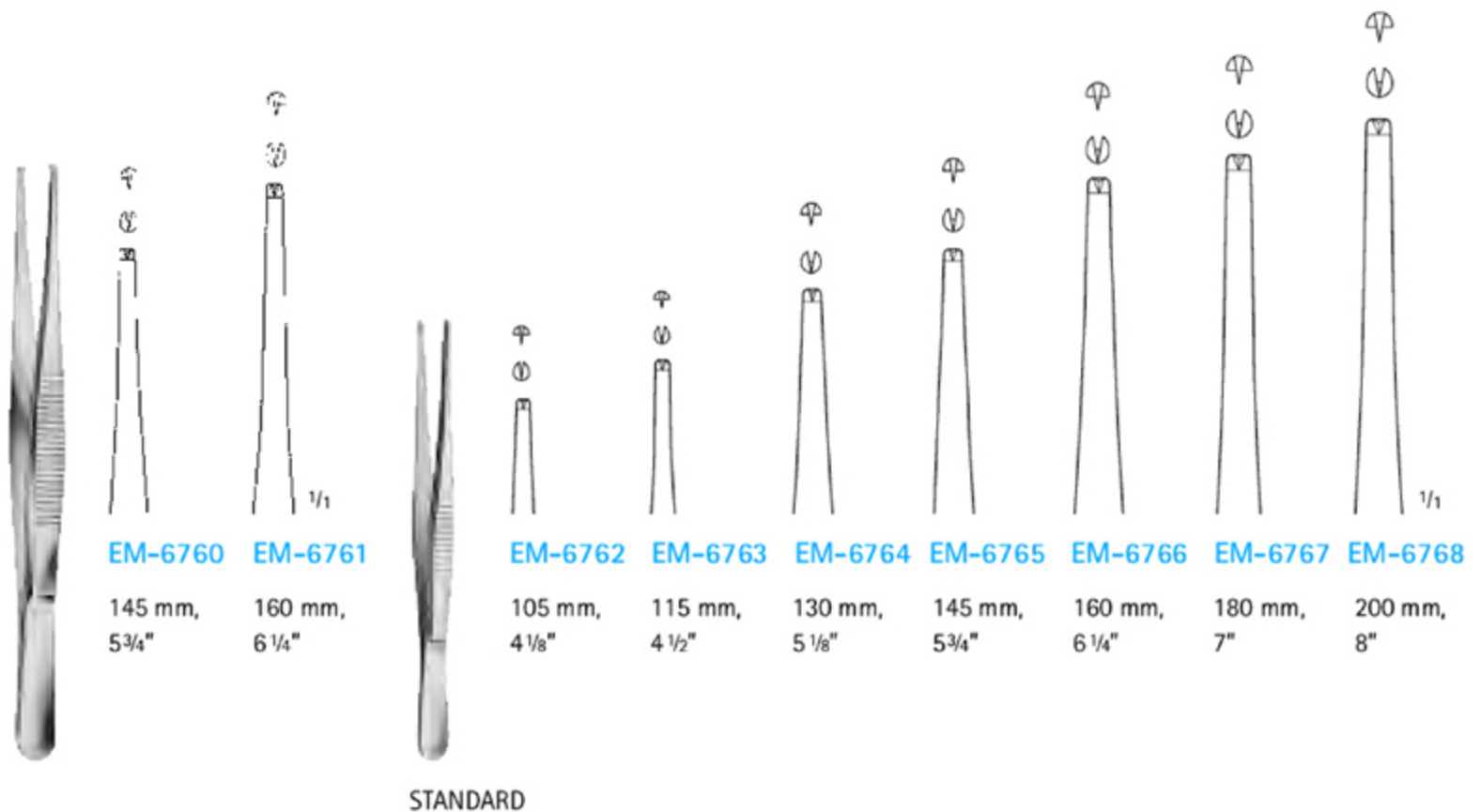

EM-6760 - EM-6761

EM-6762 - EM-6768

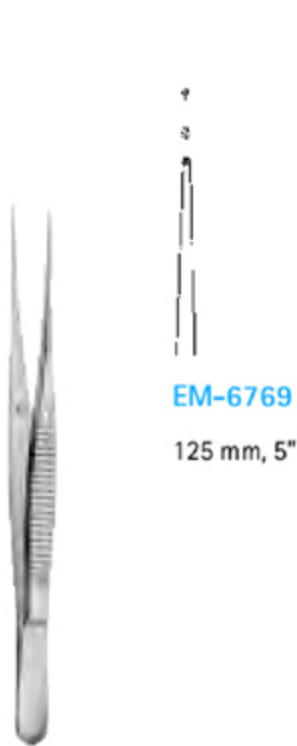

EM-6769
125 mm, 5"

SEMKEN

EM-6769 - EM-6770



EM-6770
145 mm, 5¾"



MC INDOE

EM-6771

150 mm, 6"



GILLIES

EM-6772

155 mm, 6"



EM-6773
180 mm, 7"

WAUGH

EM-6773 - EM-6774



EM-6774
200 mm, 8"



GERALD

EM-6775 - EM-6776

175 mm, 7"



EM-6775



EM-6776



BROPHY

EM-6777

200 mm, 8"

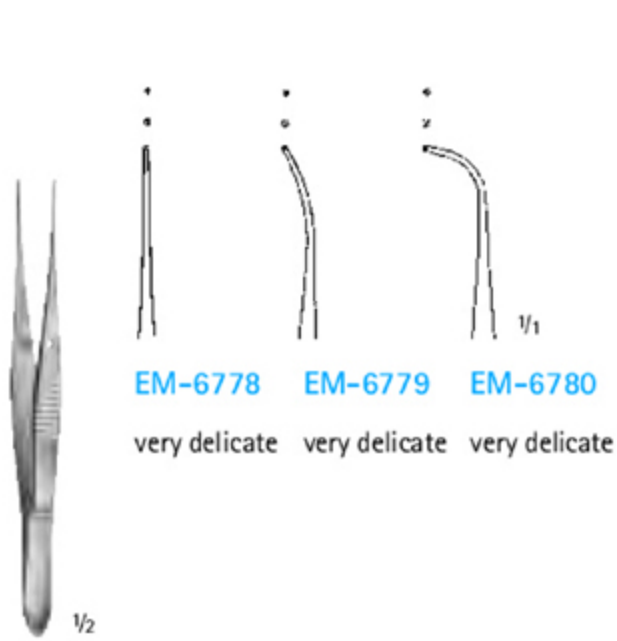

EM-6778 - EM-6780

100 mm, 4"

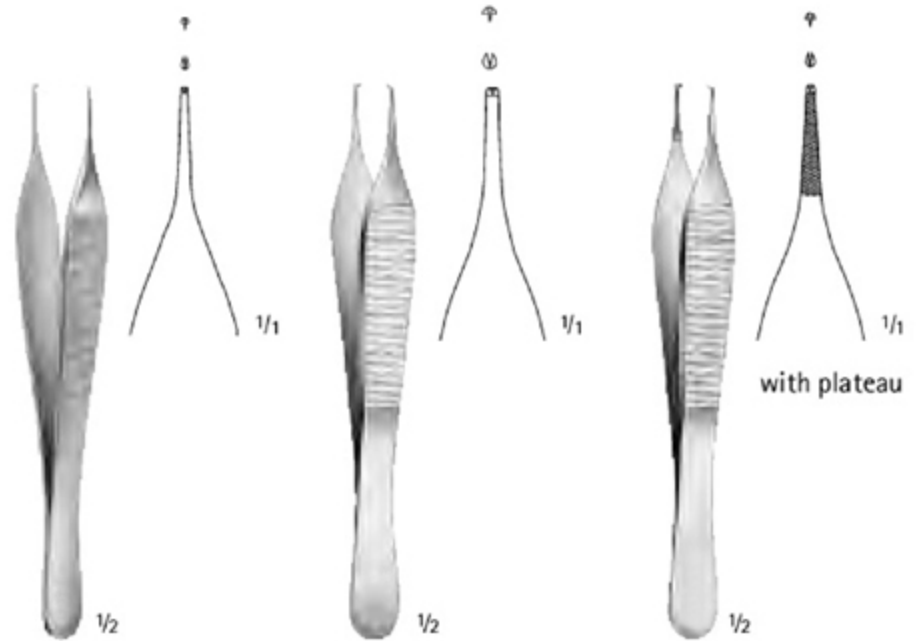

MICRO-ADSON

EM-6781

120 mm, 4 3/4"

ADSON

EM-6782

120 mm, 4 3/4"

ADSON

EM-6783

120 mm, 4 3/4"

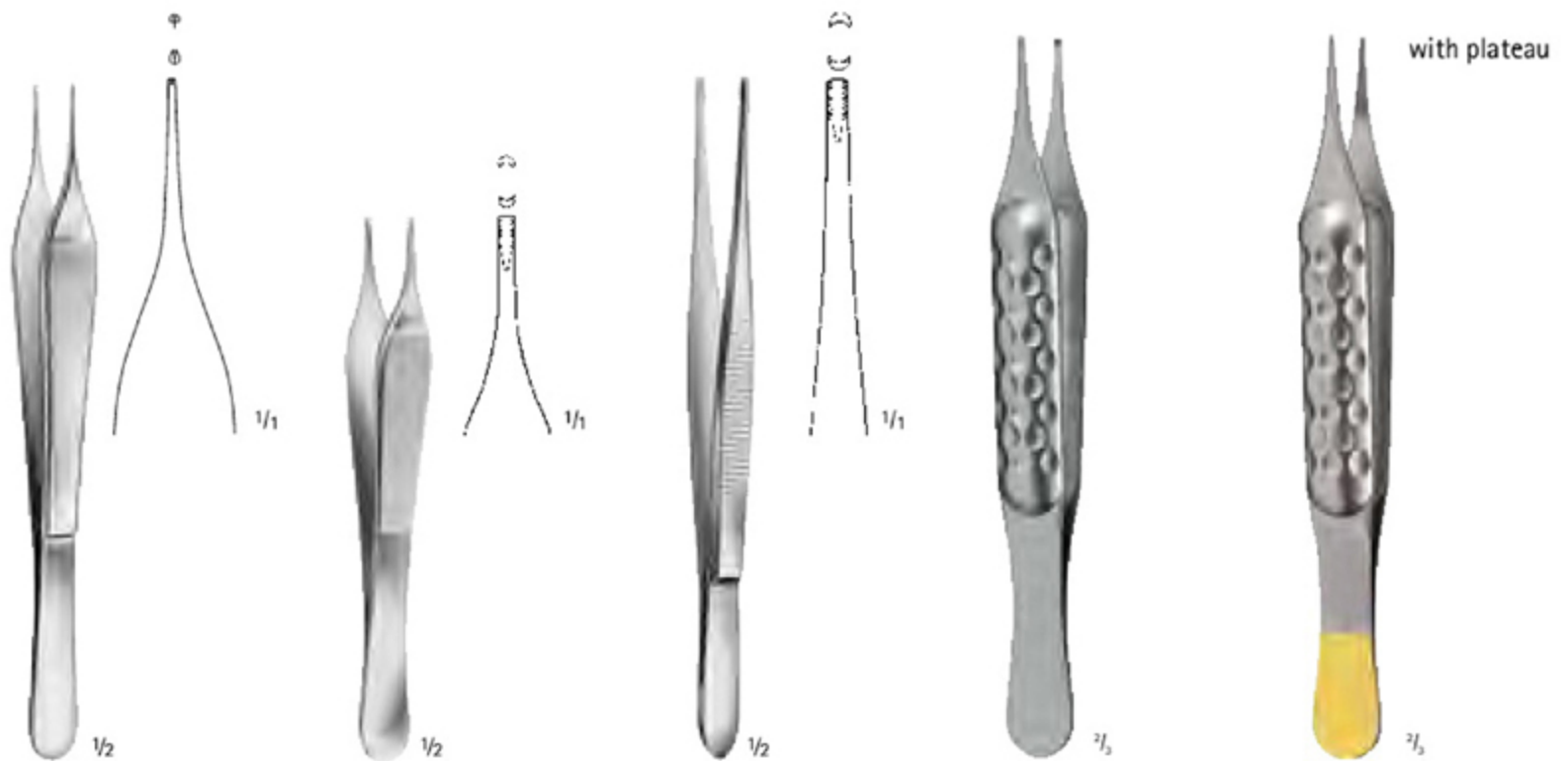

MICRO-ADSON

EM-6784

150 mm, 6"

ADSON-BROWN

EM-6785

120 mm, 4 3/4"

BROWN

EM-6786

150 mm, 6"

ERGOPLANT

EM-6787

120 mm, 4 3/4"

ERGOPLANT

EM-6788

120 mm, 4 3/4"

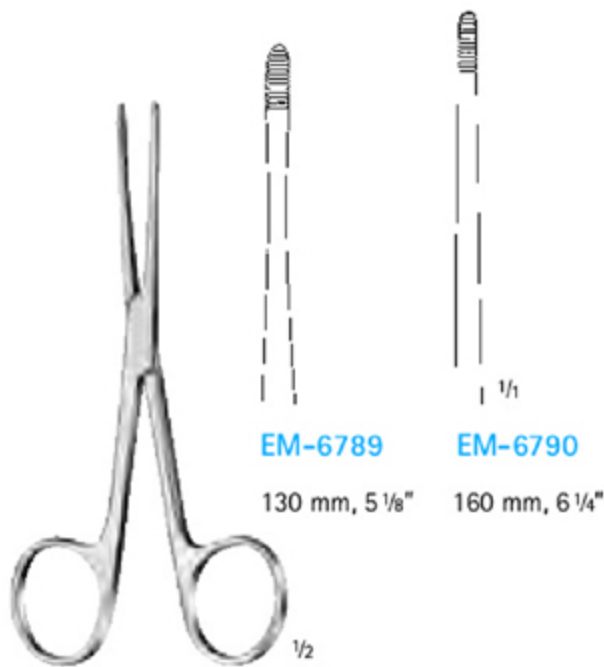

EM-6789

130 mm, 5 1/8"

EM-6790

160 mm, 6 1/4"

LISTER

EM-6789 - EM-6790

Sponge and dressing
forceps



EM-6791

Sponge and dressing
forceps

145 mm, 5 3/4"

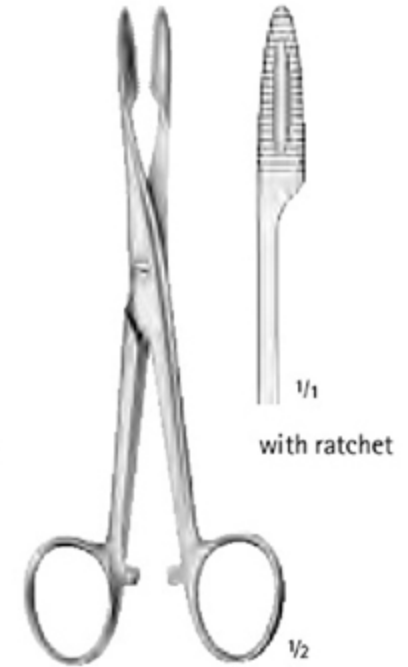

EM-6792

Sponge and dressing
forceps

145 mm, 5 3/4"

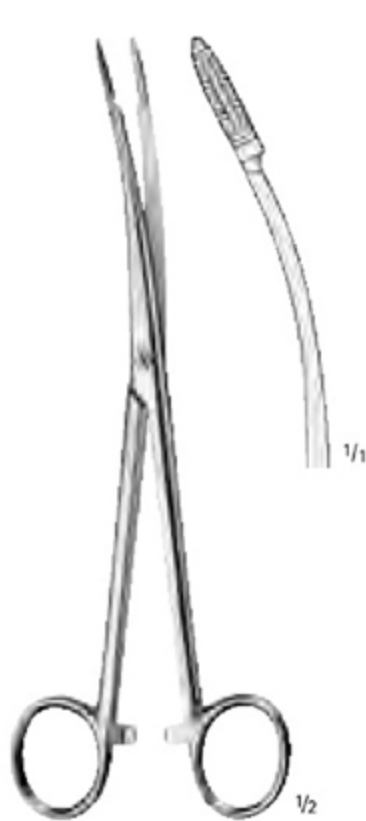

EM-6793

Sponge and dressing
forceps

175 mm, 7"

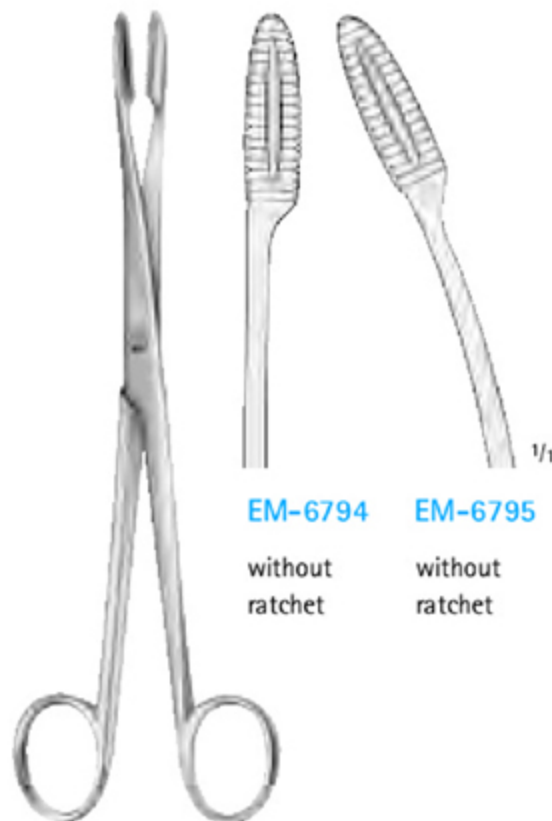

EM-6794

without
ratchet

EM-6795

without
ratchet

GROSS

EM-6794 - EM-6795

Sponge and dressing
forceps

200 mm, 8"

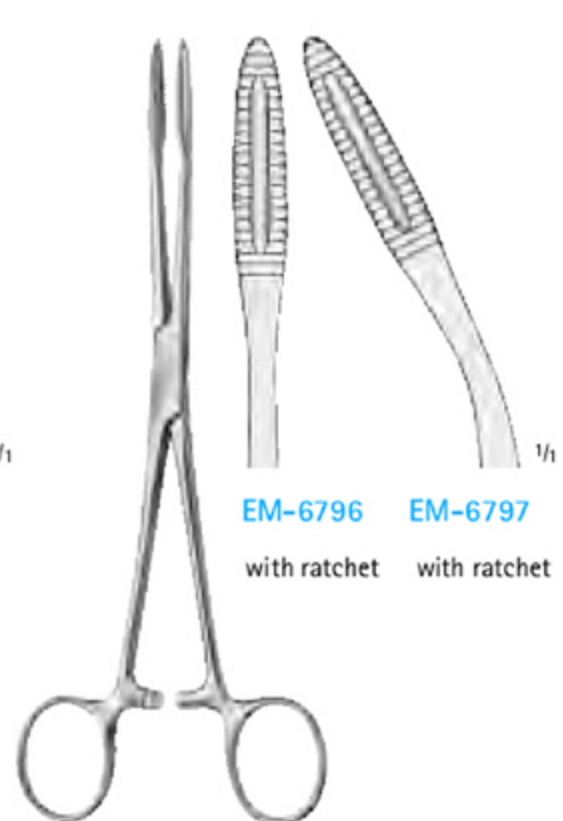

EM-6796

with ratchet

EM-6797

with ratchet

GROSS

EM-6796 - EM-6797

Sponge and dressing
forceps

200 mm, 8"



JONES

EM-6798

Towel Clamp
85 mm, 3³/₈"



ENGL. MOD.

EM-6799

Towel Clamp
85 mm, 3³/₈"

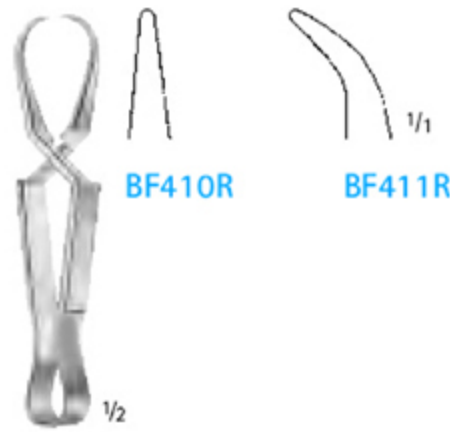

SCHAEDEL

EM-6800

Towel Clamp
85 mm, 3³/₈"

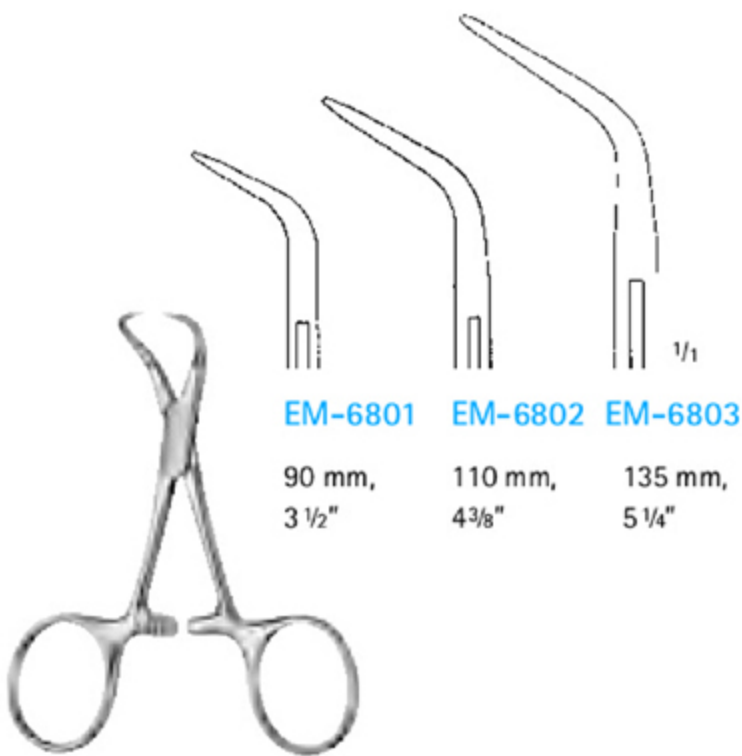

BACKHAUS

EM-6801 - EM-6803

Towel Clamp

EM-6801

90 mm,
3¹/₂"

EM-6802

110 mm,
4³/₈"

EM-6803

135 mm,
5¹/₄"

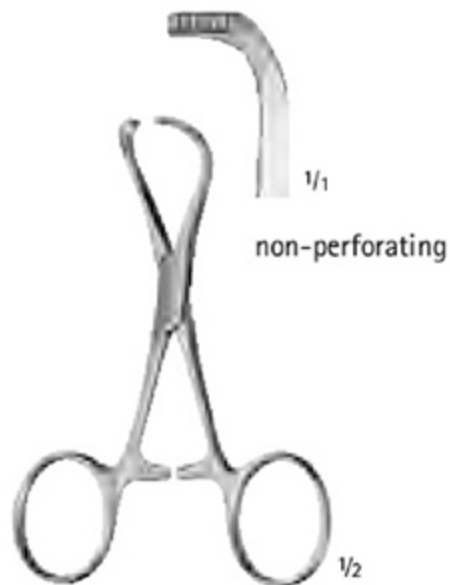

LORNA

EM-6804

Towel Clamp
95 mm, 3³/₄"

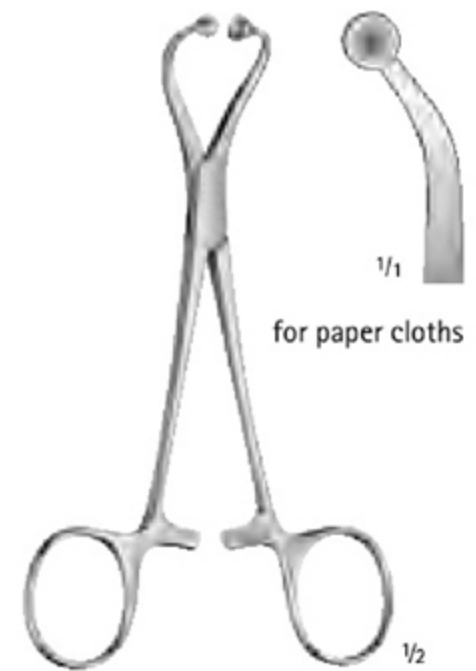

EM-6805

Towel Clamp
140 mm, 5¹/₂"

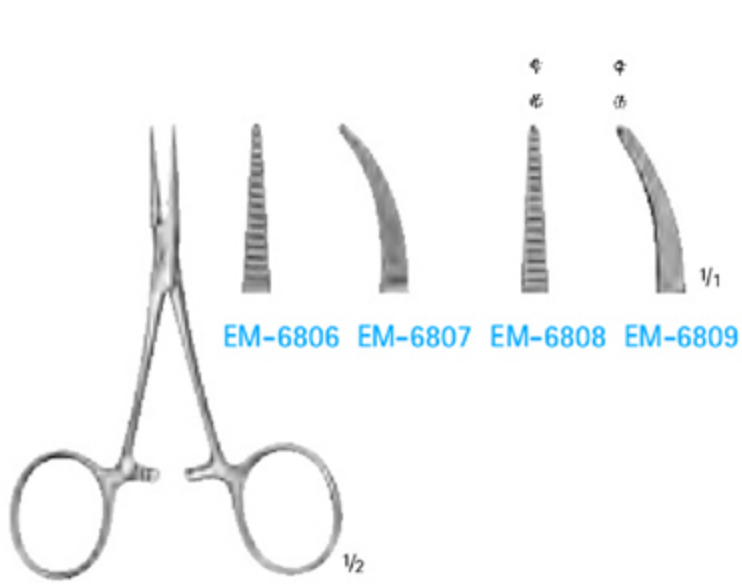

BABY-MOSQUITO (HARTMANN)

EM-6806 - EM-6809

100 mm, 4"

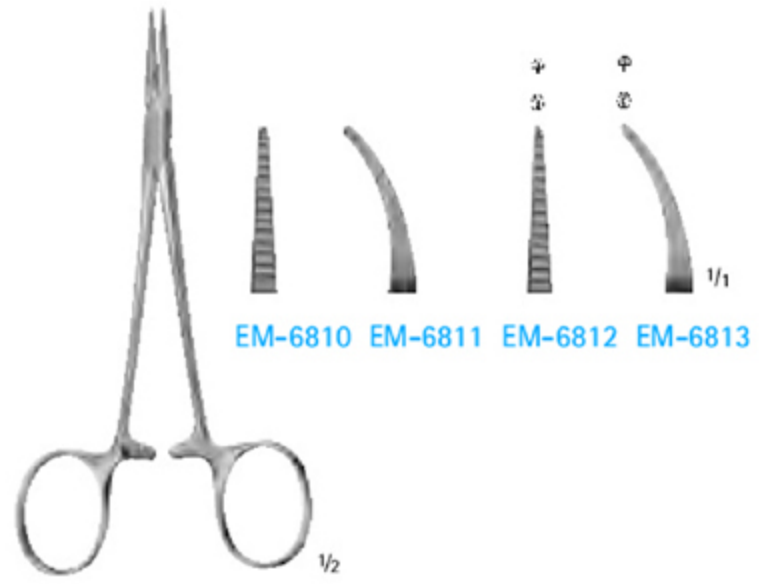

MICRO-HALSTED

EM-6810 - EM-6813

125 mm, 5"

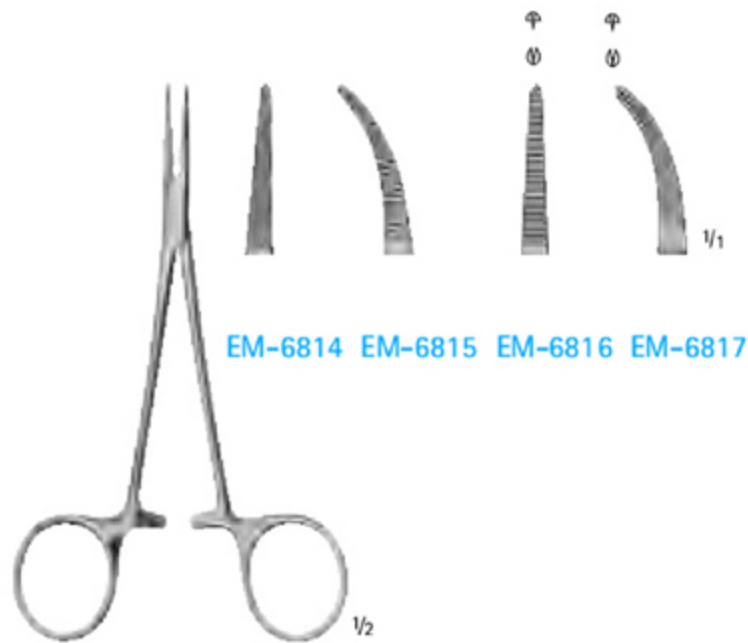

HALSTED-MOSQUITO

EM-6814 - EM-6817

125 mm, 5"



PEAN

EM-6818 - EM-6819

125 mm, 5" 140 mm, 5 1/2"



PEAN

EM-6820 - EM-6823

Grazile Form

Slender type



EM-6820 EM-6821 EM-6822 EM-6823

130 mm, 5 1/8" 140 mm, 5 1/2" 130 mm, 5 1/8" 140 mm, 5 1/2"



KELLY

EM-6824 - EM-6825

140 mm, 5 1/2"



EM-6824 EM-6825



BABY-CRILE

EM-6826 - EM-6829

140 mm, 5 1/2"



(PEAN) (PEAN) (KOCHER) (KOCHER)

EM-6826 EM-6827 EM-6828 EM-6829



CRILE

EM-6830 - EM-6833

140 mm, 5 1/2"



EM-6830 EM-6831 EM-6832 EM-6833

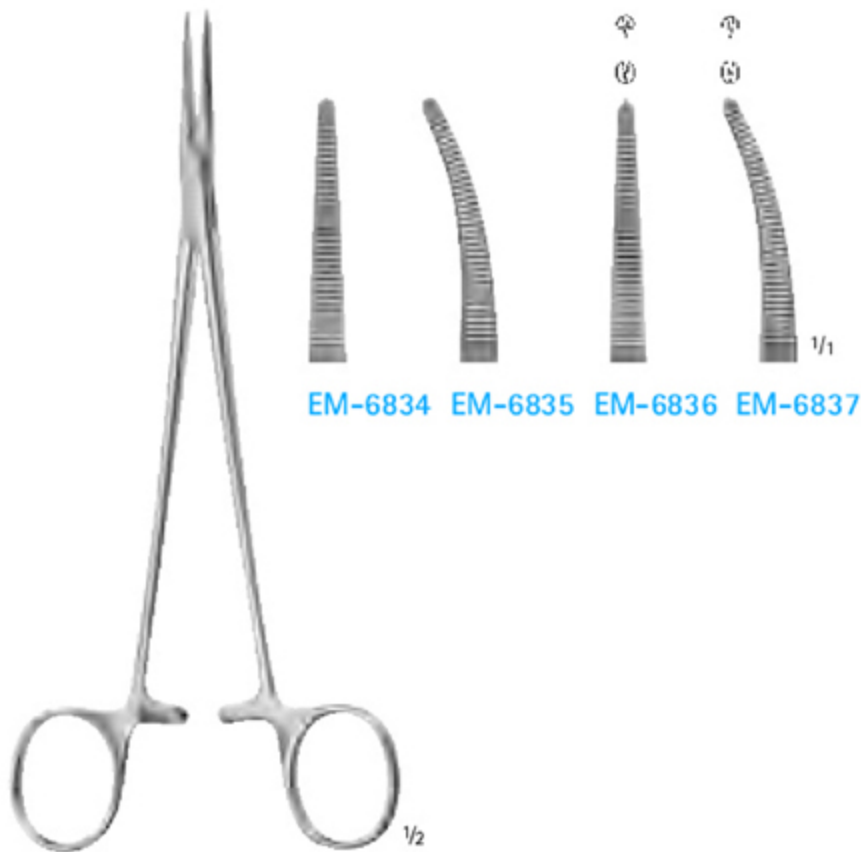

HALSTED
EM-6834 - EM-6837
 Haemostatic forceps
 185 mm, 7 1/4"

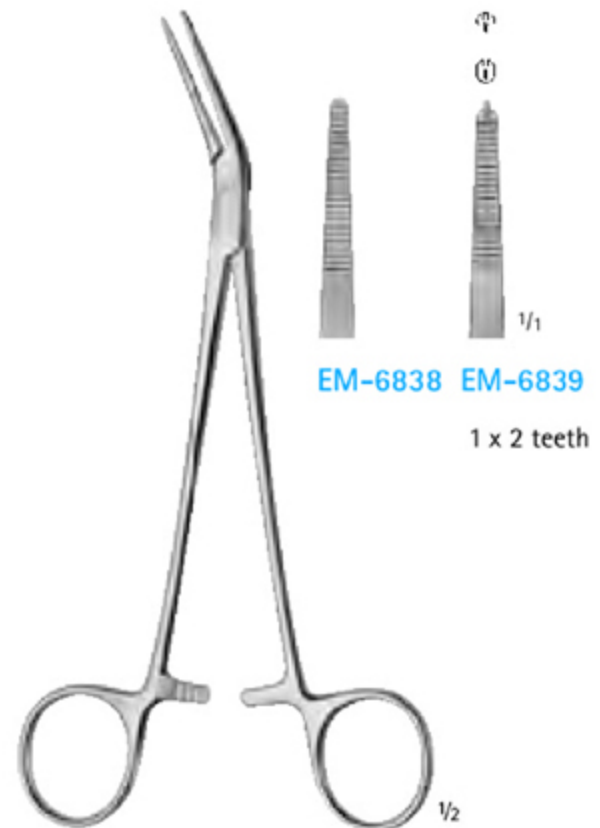

FICKLING
EM-6838 - EM-6839
 Haemostatic forceps
 180 mm, 7"



BABY-ALLIS
EM-6840
 Tissue grasping forceps
 130 mm, 5 1/8"

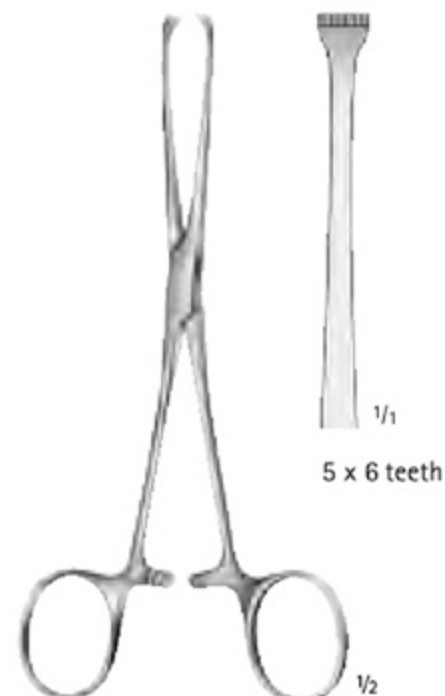

ALLIS
EM-6841
 Tissue grasping forceps
 155 mm, 6"

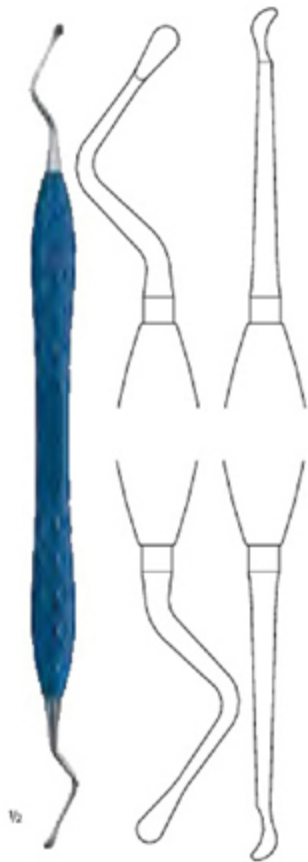

LUCAS
EM-6842
190 mm, 7 1/2"



LUCAS
EM-6843
180 mm, 7"



LUCAS
EM-6844
185 mm, 7 1/4"



EM-6845
160 mm, 6 1/4"



JANSEN
EM-6846
160 mm, 6 1/4"



HEMINGWAY
EM-6847
170 mm, 6 3/4"



HEMINGWAY
EM-6848
170 mm, 6 3/4"



HEMINGWAY
EM-6849
Fig. 0
170 mm, 6 3/4"



HEMINGWAY
EM-6850
Fig. 1
170 mm, 6 3/4"



HEMINGWAY
EM-6851
Fig. 2
170 mm, 6 3/4"



HEMINGWAY
EM-6852
Fig. 3
170 mm, 6 3/4"



HEMINGWAY
EM-6853
Fig. 4
170 mm, 6 3/4"

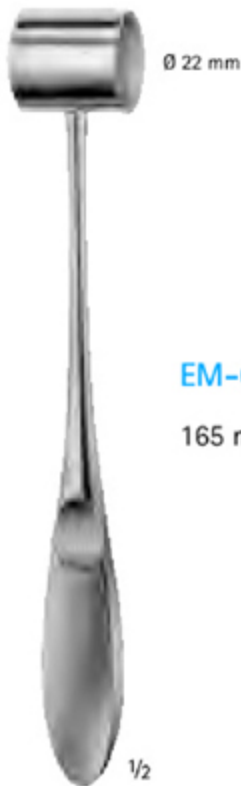

Ø 22 mm

EM-6854 80 g
165 mm, 6 1/2"

1/2



Ø 25 mm

EM-6855 155 g
190 mm, 7 1/2"

1/2



Ø 25 mm

EM-6856 135 g
With interchangeable
plastic disks
185 mm, 7 1/4"

EM-6857
Pair of spare disks

1/2

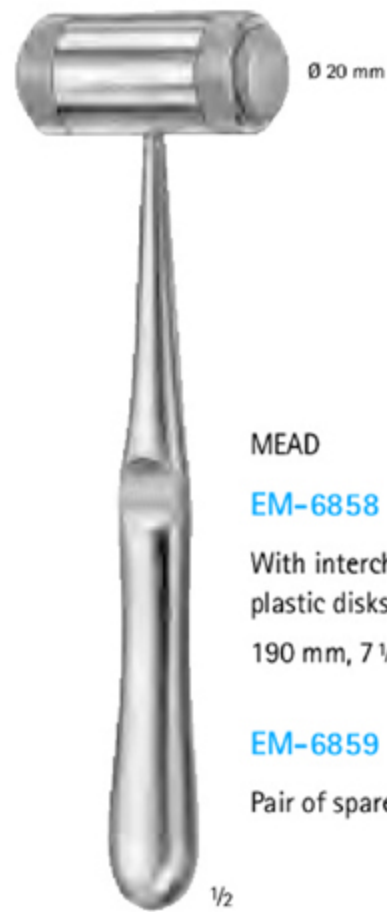

Ø 20 mm

MEAD
EM-6858 180 g
With interchangeable
plastic disks
190 mm, 7 1/2"

EM-6859
Pair of spare disks

1/2



Ø 30 mm

COTTLE

EM-6860 235 g

1 Side flat

1 Side convex

185 mm, 7 1/4"

1/2



Ø 27 mm

HAJEK

EM-6861 135 g

220 mm, 8 3/4"

1/2



Ø 25 mm

EM-6862 135 g

ERGOPLANT Mallet,
with interchangeable plastic disks
200 mm, 8"

EM-6863

Pair of spare disks

1/2

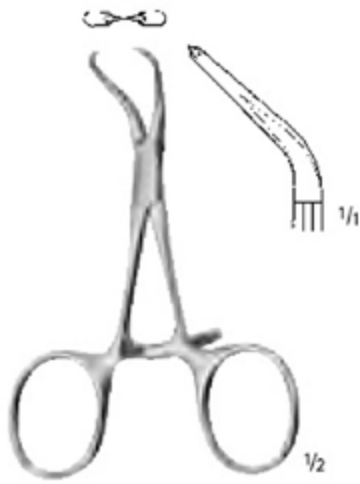

EM-6864

Reposition forceps with stepped tips,
long ratchet
95 mm, 3 3/4"



EM-6865

Reposition forceps for small fragments
135 mm, 5 1/4"

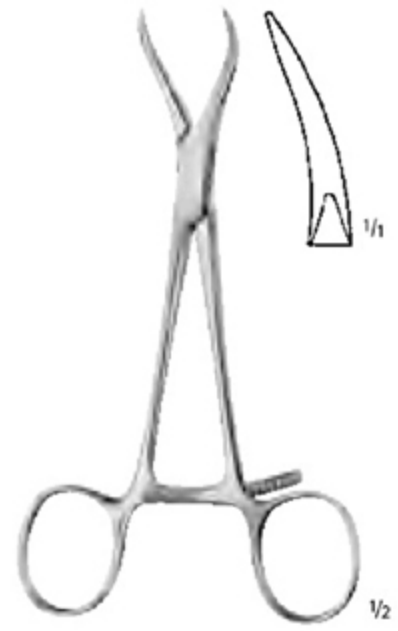

EM-6866

Reposition forceps,
especially for maxillary reposition
135 mm, 5 1/4"



HAASE

EM-6867

Reposition forceps for mandibular fractures
165 mm, 6 1/2"

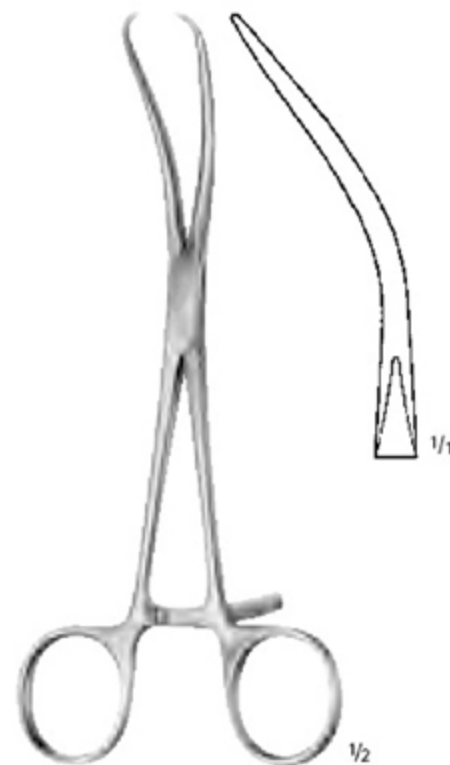

REILL

EM-6868

Reposition forceps
170 mm, 6 3/4"



EM-6869
Bone holding forceps
200 mm, 8"



DINGMANN
EM-6870
Bone holding forceps
185 mm, 7 1/4"



DINGMANN, modif.
EM-6871
Bone holding forceps
185 mm, 7 1/4"



LUER-FRIEDMANN

EM-6872

ERGOPLANT

145 mm, 5 3/4"



LUER-FRIEDMANN

EM-6873

145 mm, 5 3/4"



EM-6874

150 mm, 6"



EM-6875

140 mm, 5 1/2"



LUER

EM-6876

150 mm, 6"



LUER

EM-6877

155 mm, 6"



SCHWARZ
EM-6878
145 mm, 5³/₄"



BLUMENTHAL
EM-6879
155 mm, 6"



BLUMENTHAL
EM-6880
155 mm, 6"



STELLBRINK
EM-6881
175 mm, 7"



STELLBRINK
EM-6882
170 mm, 6³/₄"



BEYER
EM-6883
180 mm, 7"

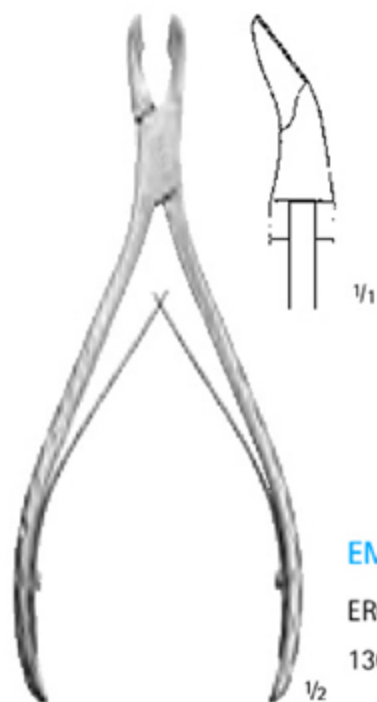

EM-6884

ERGOPLANT Bone cutting forceps, curved
130 mm, 5 1/8"



STAMM

EM-6885

Bone cutting forceps
150 mm, 6"



MEAD

EM-6886

Bone rongeur
165 mm, 6 1/2"



BANE-HARTMANN

EM-6887

Bone rongeur
175 mm, 7"

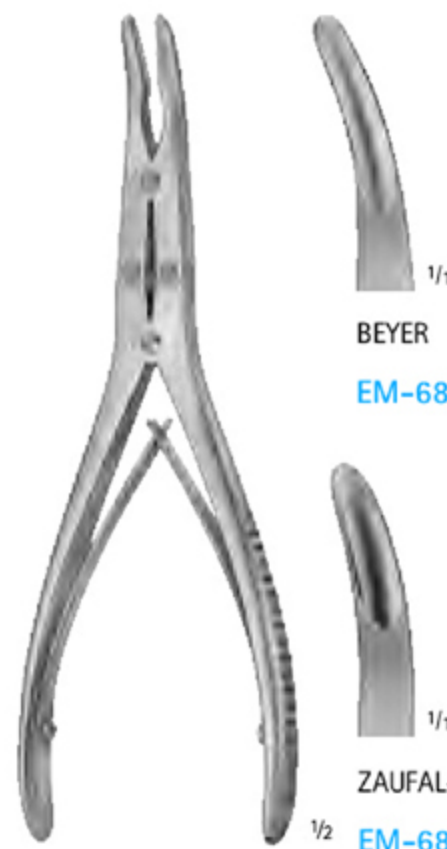

BEYER

EM-6888

EM-6888 - EM-6889

Bone rongeur
180 mm, 7"



ZAUFGAL-JANSEN

EM-6889



HALSEY
EM-6890
 Needle holder
 130 mm, 5 1/8"



BAUMGARTNER
EM-6891
 Needle holder
 145 mm, 5 3/8"



CRILE-MURRAY
EM-6892
 Needle holder
 150 mm, 6"

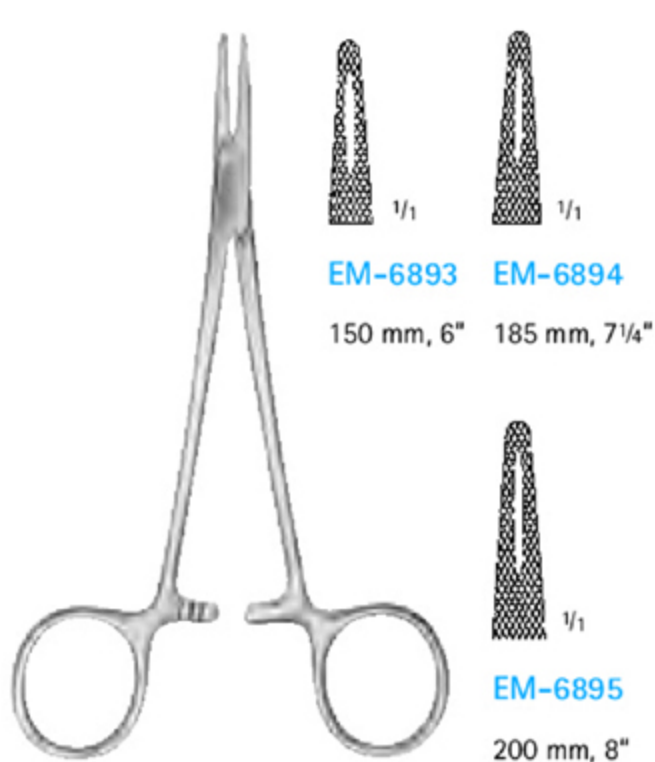

MAYO-HEGAR
EM-6893 - EM-6895
 Needle holder
 medium fine patterns

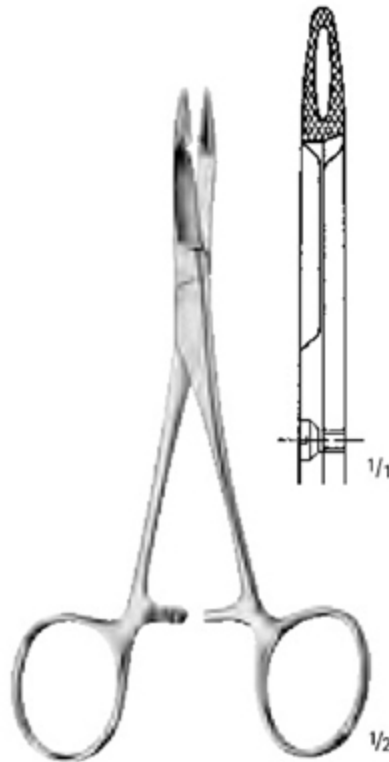

HEGAR-OLSEN
EM-6896
 Needle holders with scissors
 140 mm, 5 1/2"

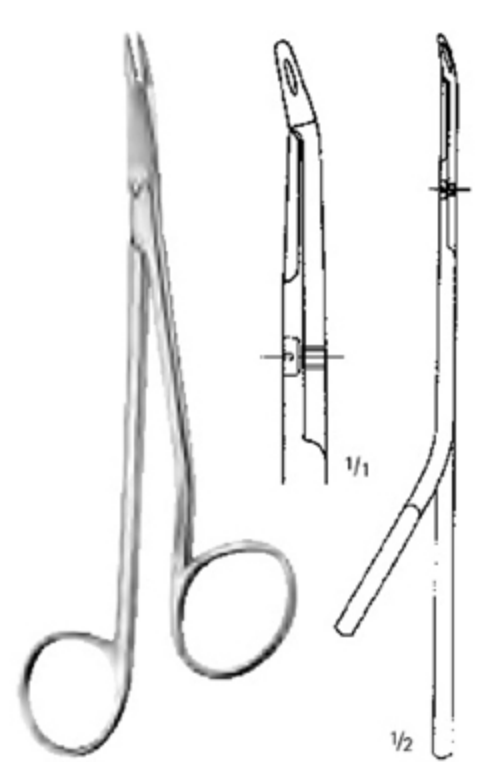

GILLIES
EM-6897
 Needle holder with scissors
 150 mm, 6"



MATHIEU

EM-6898 - EM-6900

Needle holder



1/1

EM-6898

140 mm, 5 1/2"



1/1

EM-6899

170 mm, 6 3/4"



1/1

EM-6900

200 mm, 8"



CRILE

EM-6901

Needle holder

150 mm, 6"



TOENNIS

EM-6902

Needle holder, elastic pattern

180 mm, 7"

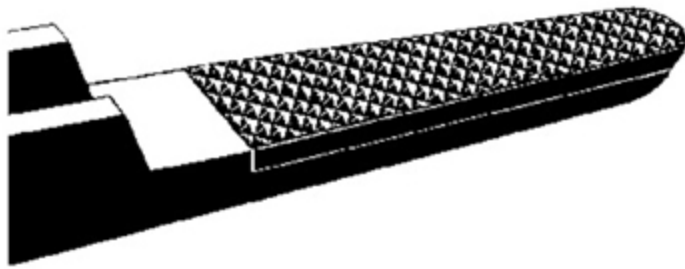

Needle holders have jaws with carbide inserts and according to the use required the resp. structure can be chosen. A smooth jaw surface as well as 3 different serrations enable a sure "grip" of the resp. needle.

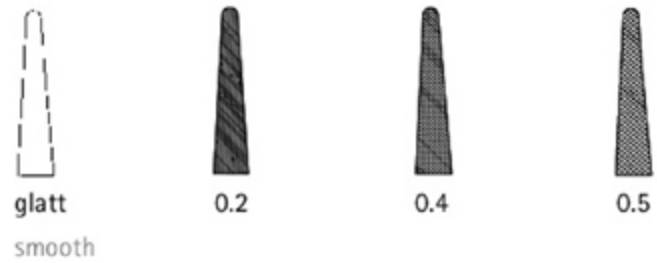

We recommend carbide inserts

with smooth jaw surface for suture material	9/0 – 11/0
with 0.2 mm pitch of serration for suture material	6/0 – 10/0
0.4 mm	4/0 – 6/0
0.5 mm	up to 3/0



Needle holders with carbide inserts
Identification:
gold-plated rings, handle ends and ratchets

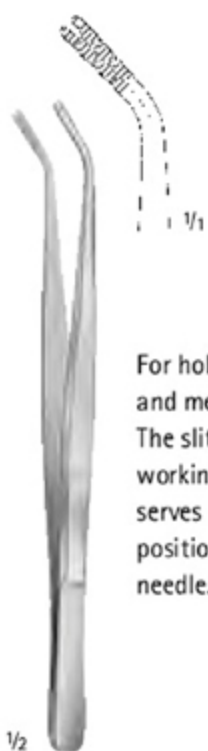

For holding tissue and membranes. The slit in the working tip serves for precise positioning of the needle.

EM-6903

Suture forceps, angulated
150 mm, 6"



CASTROVIEJO

EM-6904

DUROGRIP™ Needle holder
145 mm, 5 1/4"



EM-6905

DUROGRIP™ Needle holder
180 mm, 6 3/4"



EM-6906

DUROGRIP™ Needle holder
180 mm, 7"

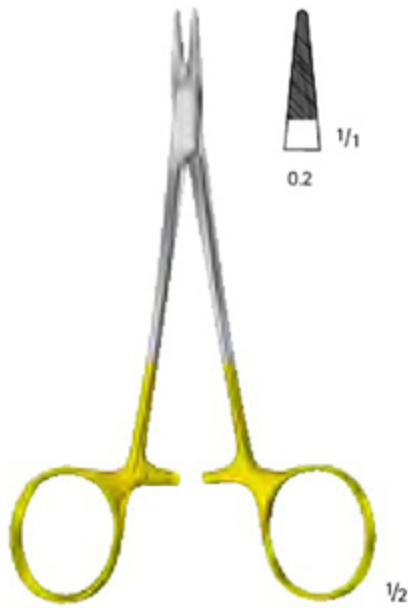

CONVERSE
EM-6907
 very delicate
 130 mm, 5 1/8"

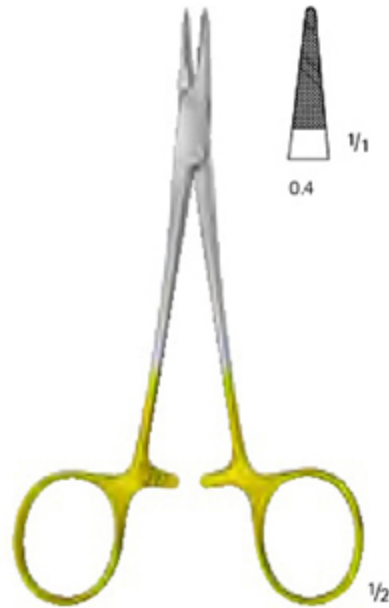

HALSEY
EM-6908
 130 mm, 5 1/8"

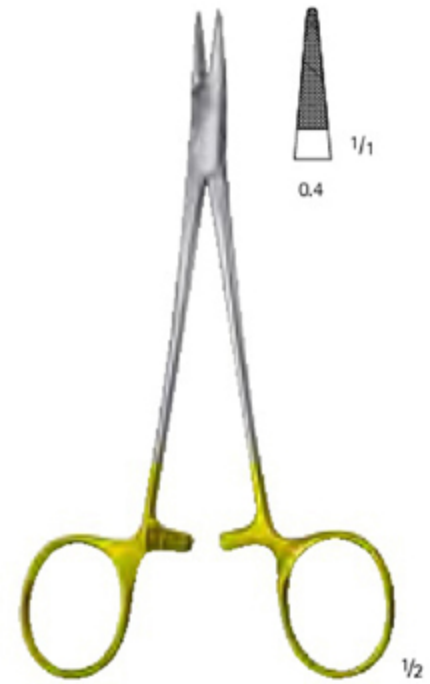

BABY-CRILE-WOOD
EM-6909
 150 mm, 6"

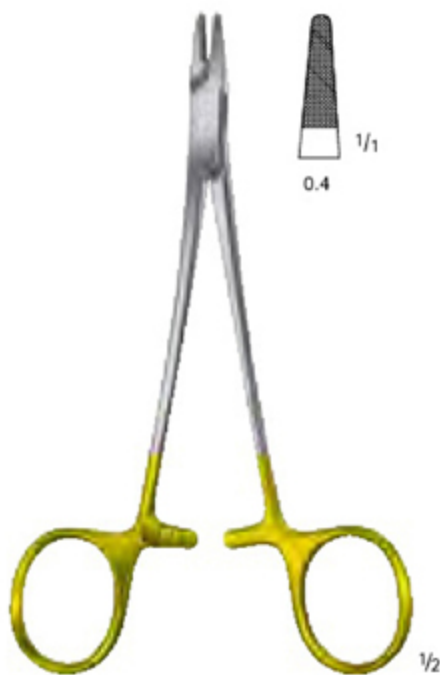

CRILE-WOOD
EM-6910
 145 mm, 5 3/4"

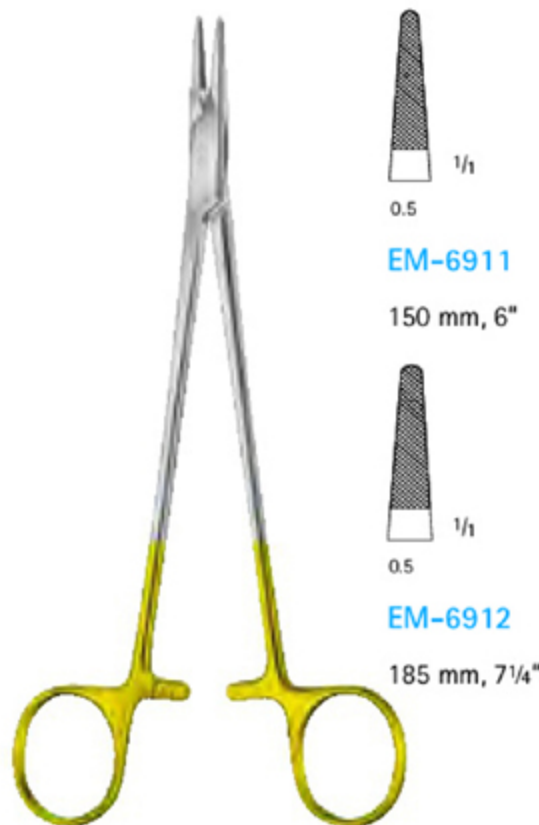

HEGAR-MAYO
EM-6911 - EM-6912

EM-6911
 150 mm, 6"

EM-6912
 185 mm, 7 1/4"

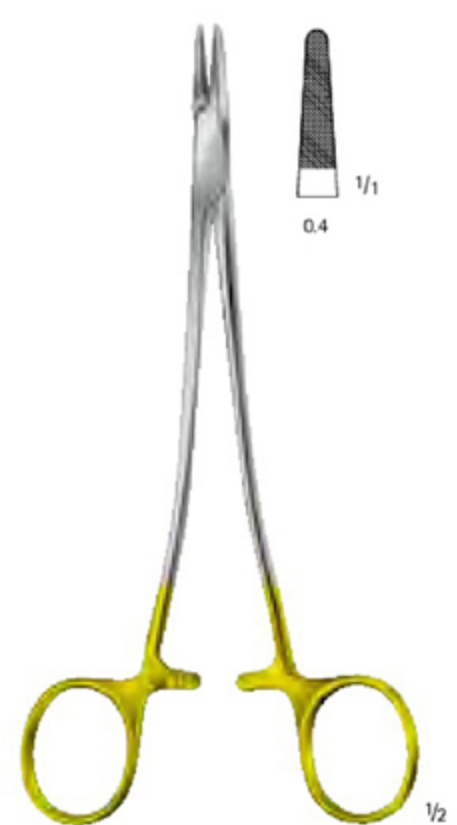

SAROT
EM-6913
 175 mm, 7"



DE BAKEY

EM-6914 - EM-6917

very delicate

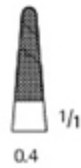

EM-6914

165 mm, 6 1/2"



EM-6915

210 mm, 8 1/4"



EM-6916

165 mm, 6 1/2"



EM-6917

210 mm, 8 1/4"



DE BAKEY

EM-6918 - EM-6919



EM-6918

150 mm, 6"



EM-6919

180 mm, 7"



RYDER

EM-6920 - EM-6922

very delicate



EM-6920

135 mm, 5 1/4"



EM-6921

155 mm, 6"



EM-6922

175 mm, 7"

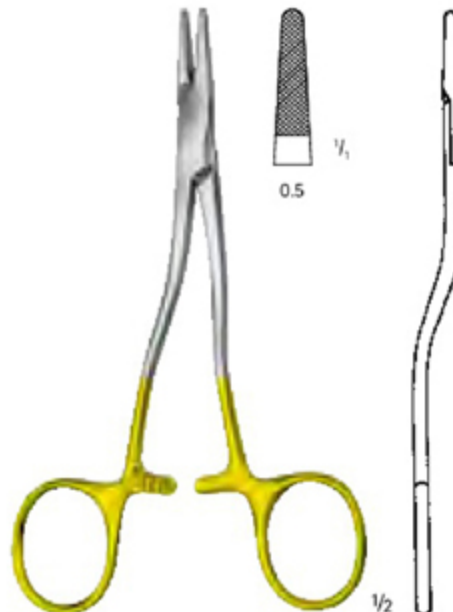

KILNER

EM-6923

135 mm, 5 1/4"

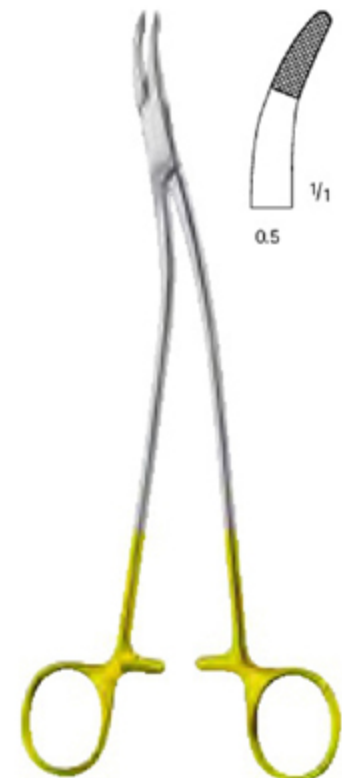

STRATTE

EM-6924

210 mm, 8 1/4"



Needle holder with
scissors, one blade fine
serrated

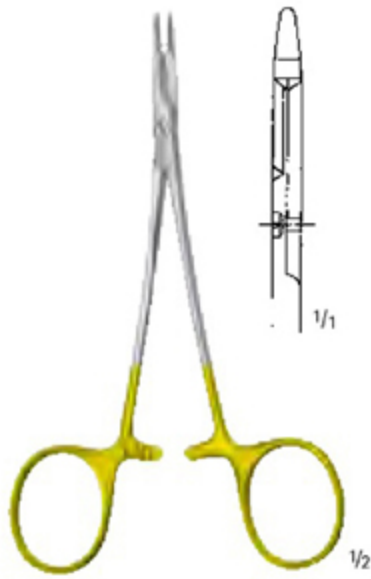

EM-6925

With smooth jaws
125 mm, 5"

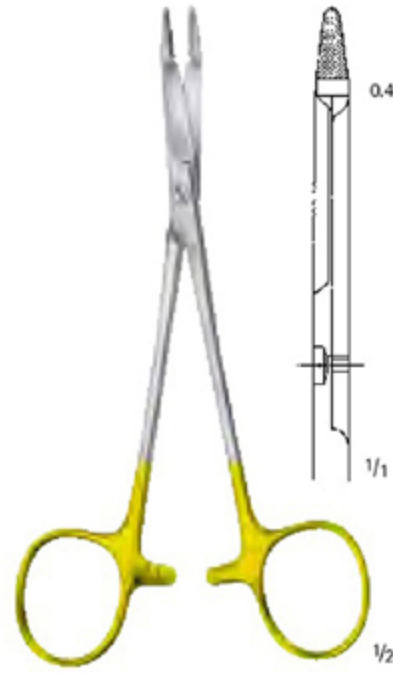

HEGAR-OLSEN modif. LANGE

EM-6926

145 mm, 5 3/4"

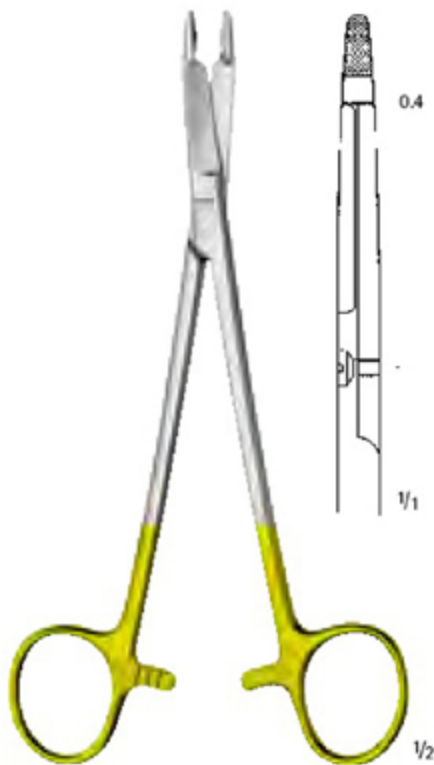

HEGAR-OLSEN

EM-6927

165 mm, 6 1/2"

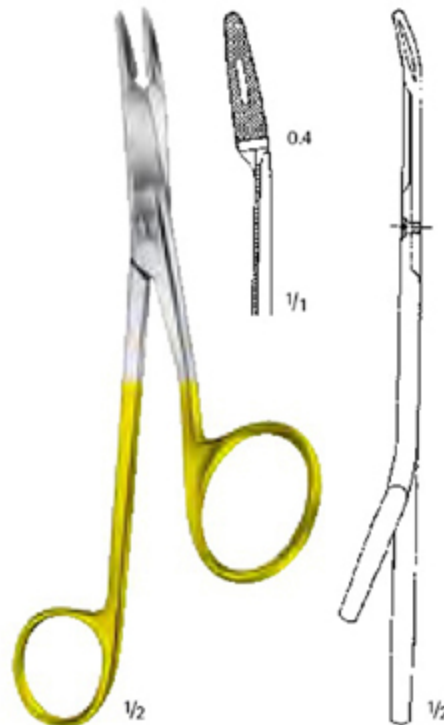

GILLIES

EM-6928

160 mm, 6 1/4"



TOENNIS

EM-6929

Elastic pattern
180 mm, 7"



EM-6930

200 mm, 8"



LANGENBECK

EM-6931

200 mm, 8"

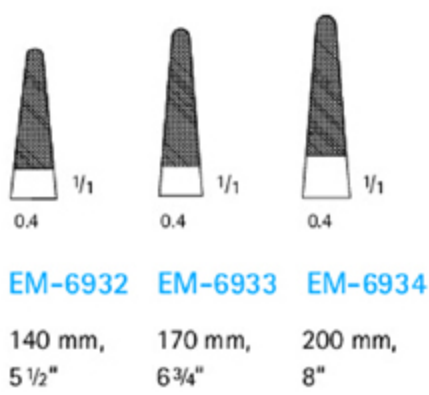

EM-6932 **EM-6933** **EM-6934**

140 mm, 5 1/2" 170 mm, 6 3/4" 200 mm, 8"

MATHIEU

EM-6932 - EM-6934

DUROGRIP™ Needle holder, delicate pattern

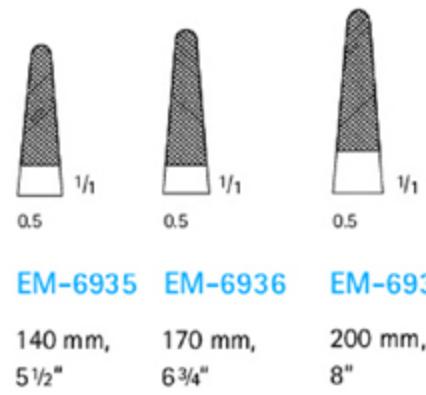
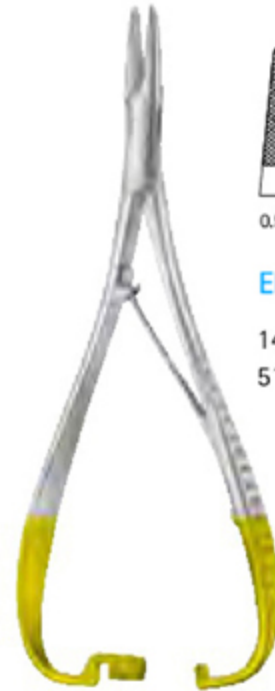

EM-6935 **EM-6936** **EM-6937**

140 mm, 5 1/2" 170 mm, 6 3/4" 200 mm, 8"

MATHIEU-STANDARD

EM-6935 - EM-6937

DUROGRIP™ Needle holder



LICHTENBERG

EM-6938

DUROGRIP™ Needle holder, elastic pattern
195 mm, 7 3/4"

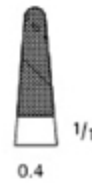

HÖSEL

EM-6939

DUROGRIP™ Needle holder with long neck
205 mm, 8"

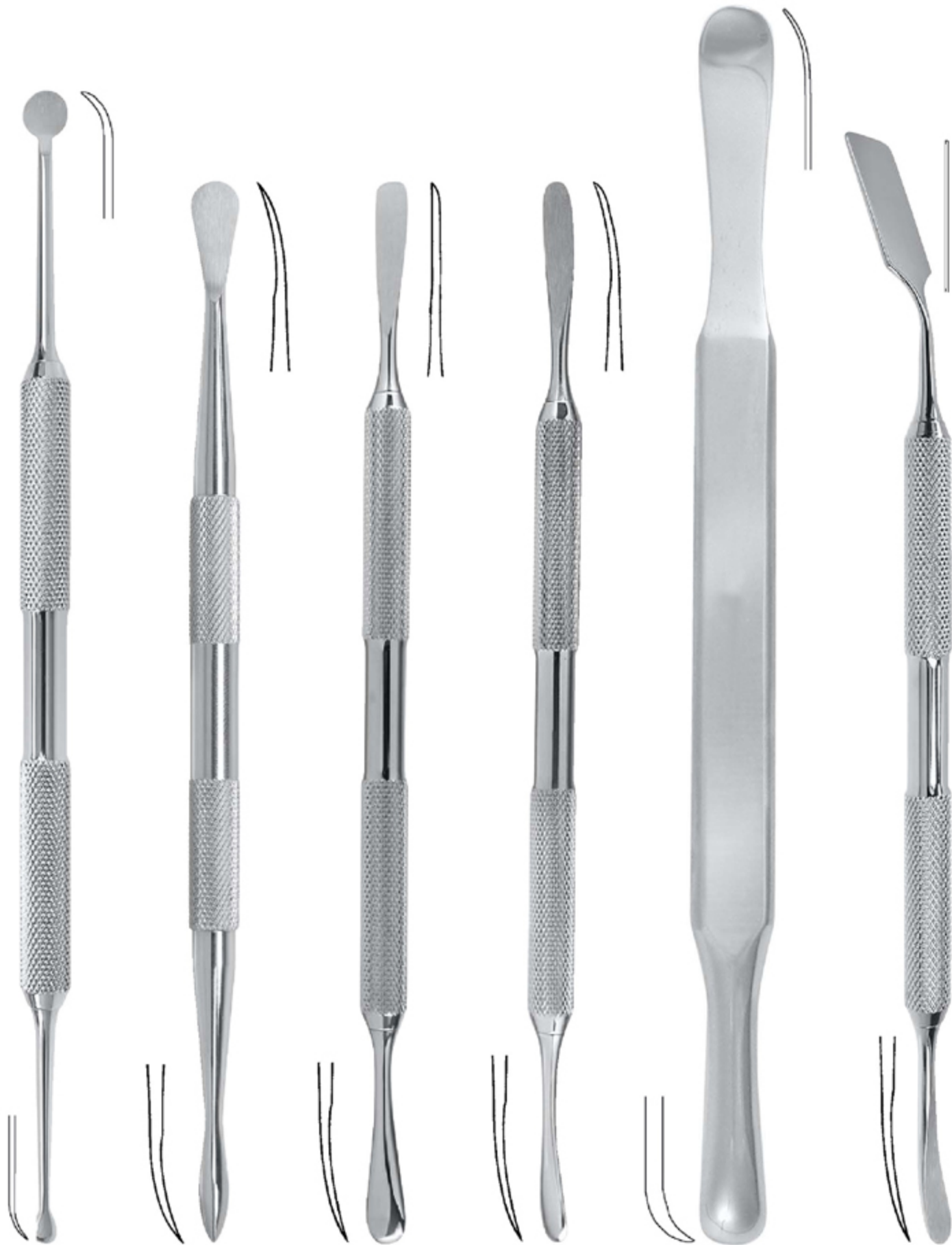

EM-1407-24
MOLT
FIG. 2/4
3,0 / 6,0 mm

EM-1400
MOLT
FIG. 9
5,0 / 8,0 mm

EM-1406
FOX
5,0 / 7,0 mm

EM-1407
MOLT
5,0 / 5,0 mm

EM-1393 **EM-1393-1**
SELDIN SELDIN
FIG. 23 FIG. 23

EM-1405
PRICHARD
10,0 / 5,0 mm

serrated

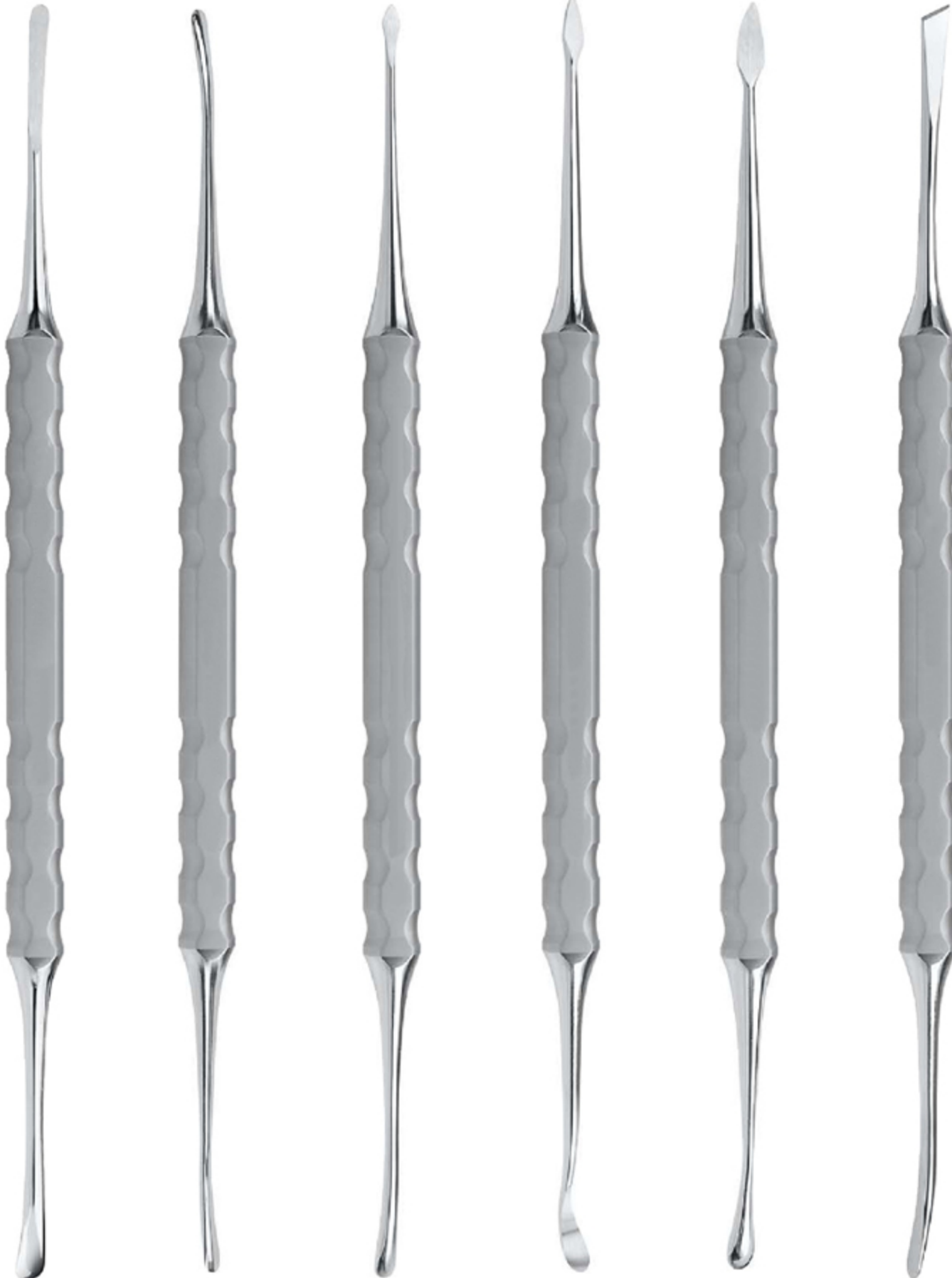

EM-1411-01
MOLT
2,5 / 4,0 mm
17,5 cm

EM-1411-07
2,6 / 2,6 mm
17,5 cm
fine

EM-1411-04
MICRO-BUSER
2,4 / 2,8 mm
17,5 cm

EM-1411-05
BUSER
3,8 / 4,2 mm
17,5 cm

EM-1411-06
BUSER
3,8 / 4,2 mm
17,5 cm
curved

EM-1411-03
GLICKMANN
FIG. 24G
17,5 cm

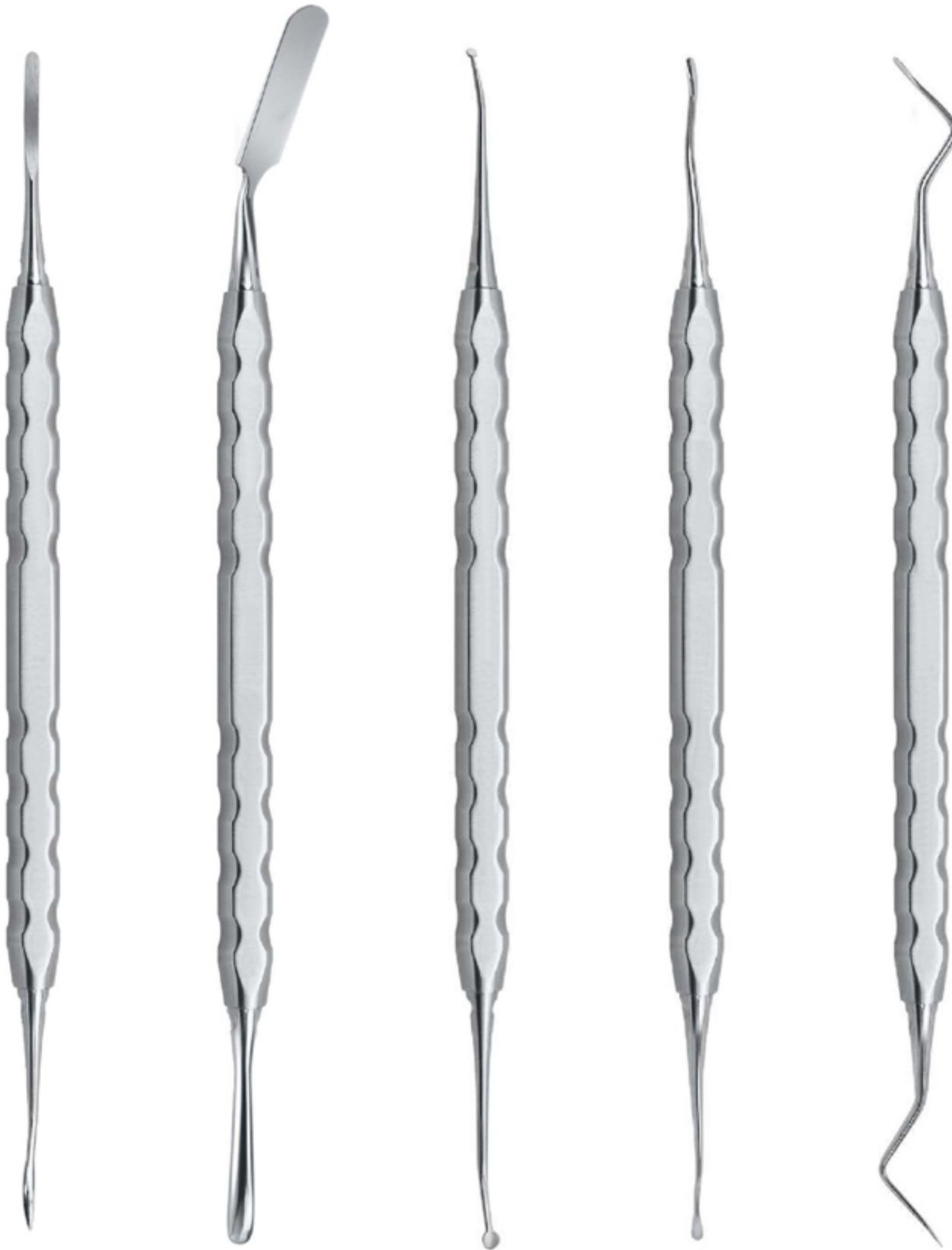

EM-1411-02

1,8 / 3,4 mm
17,5 cm
Dissection /
periosteal
exchangeable

EM-1411-08

PRICHRAD
17,5 cm
Spatula / 4,0 mm
periosteal
exchangeable

EM-1705-15

Papilla elevator
1,5 / 2,5 mm
17,5 cm
exchangeable

EM-1705-25

Tunneling knife
FIG. 1, OK, Maxilla
18,0 cm
exchangeable

EM-1705-25

Tunneling knife
FIG. 2, UK, Mandible
18,0 cm
exchangeable



EM-1471
MILLER-
COLBURN
17,0 cm



EM-1472
MILLER-
COLBURN
17,0 cm



EM-1461
MILLER-
COLBURN
17,0 cm



EM-1462
MILLER-
COLBURN
17,0 cm



EM-1650-1
OCHSENBEIN
16,0 cm



EM-1650-2
OCHSENBEIN
16,0 cm



EM-1650-15
WEDELSTAEDT
FIG. 5/6



EM-1650-30
OCHSENBEIN
FIG. 3



EM-1650-40
OCHSENBEIN
FIG. 4



EM-1650-365
RHODES
BACK ACTION
FIG. 36/37



EM-1651-1
FEDI
FIG. 1



EM-1651-2
FEDI
FIG. 2

graduation
1-20 in mm



EM-1682-4

EPKER
4,0 mm
18,0 cm

EM-1682-6

EPKER
6,0 mm
18,0 cm

EM-1682-8

EPKER
8,0 mm
18,0 cm

EM-1682-16

EPKER
6,0 mm
18,0 cm

EM-1682-18

EPKER
8,0 mm
18,0 cm

EM-1682-26

EPKER
6,0 mm
18,0 cm

EM-1682-28

EPKER
8,0 mm
18,0 cm

graduation
1-15 in mm



EM-1675-06

LEXER-MINI
OSTEOTOME
6,0 mm
18,0 cm

EM-1676-06

LEXER-MINI
GOUGES
6,0 mm
18,0 cm

EM-1675-08

LEXER-MINI
OSTEOTOME
8,0 mm
18,0 cm

EM-1676-08

LEXER-MINI
GOUGES
8,0 mm
18,0 cm

EM-1675-10

LEXER-MINI
OSTEOTOME
10,0 mm
18,0 cm

EM-1676-10

LEXER-MINI
GOUGES
10,0 mm
18,0 cm

EM-1672-3

LUCAS
3,0 mm

EM-1672-4

LUCAS
4,0 mm

EM-1672-13

LUCAS
3,0 mm

EM-1672-14

LUCAS
4,0 mm





EM-1637
220 g, 18,5 cm
Ø 25,0 mm
interchangeable inserts
sterilizable up to 140°C

EM-1637-1
without illustration
1 pair replacement Teflon inserts for 1637



EM-1634
130 g, 16,5 cm
Ø 20 mm, massiv
sterilizable up to 140°C



EM-1632
MEAD, 320 g, 19,0 cm
interchangeable inserts
sterilizable up to 140°C

EM-1632-1
without illustration
1 pair replacement Teflon inserts for 1632



EM-1510
LUNIATSCHEK
2,5 mm
Tampon applicator



EM-1510-1
LUNIATSCHEK
1,8 mm
Tampon applicator



EM-1524-13
Ø 1,0 mm
13,0 cm
Antrum probes

EM-1524-14
Ø 2,0 mm
14,0 cm
Antrum probes



EM-1528-000
FIG. 0000/000
Ø 0,6 / 0,7 mm
13,0 cm

EM-1528-20
FIG. 000/00
Ø 0,7 / 0,8 mm
13,0 cm

EM-1528-10
FIG. 00/0
Ø 0,8 / 0,9 mm
13,0 cm

EM-1528-1
FIG. 0/1
Ø 0,9 / 1,0 mm
13,0 cm

EM-1528-2
FIG. 1/2
Ø 1,0 / 1,1 mm
13,0 cm

EM-1528-3
FIG. 2/3
Ø 1,1 / 1,2 mm
13,0 cm

EM-1528-4
FIG. 3/4
Ø 1,2 / 1,3 mm
13,0 cm



EM-1835
FARABEUF
13,0 cm



EM-1947
BOWDLER-HENRYS
16,5 cm



EM-1935
SCHAEFER
23,0 cm



EM-2502-1
MIDDELDORPF
17,0 cm

EM-2502-2
MIDDELDORPF
22,0 cm



EM-2462
STERNBERG
16,0 cm

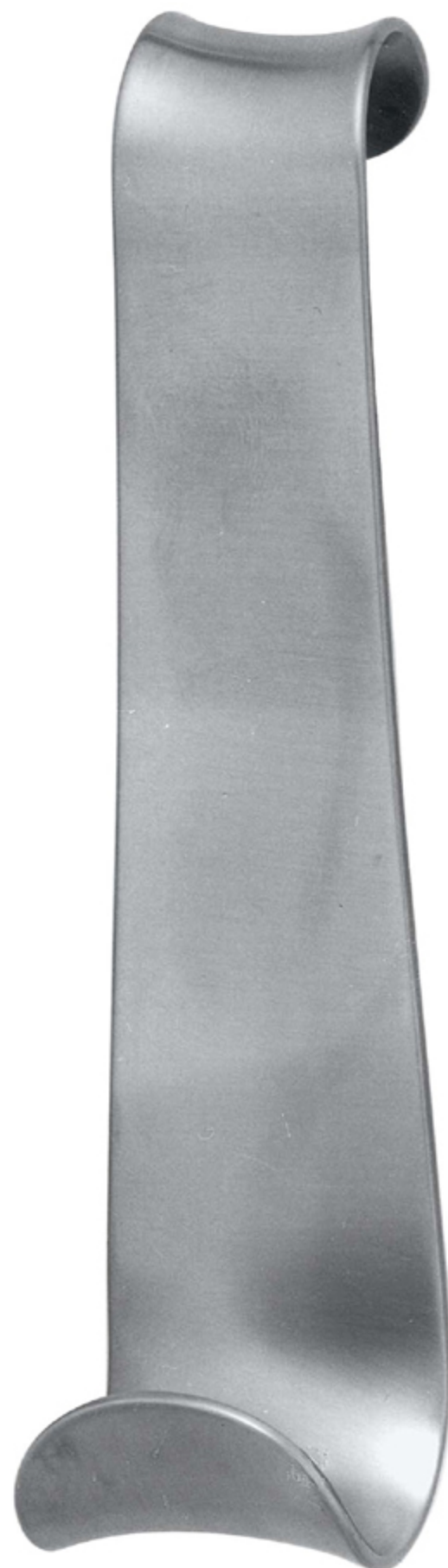

EM-2470
ROUX
17,0 cm



EM-2355
BRUENINGS
19,0 cm
Tongue retractor



EM-2460
CAWOOD-
MINNESOTA
16,0 cm



EM-2460-1
MINNESOTA
16,0 cm



EM-2206
DENHART
13,0 cm



EM-4940-101
1 pair of silicone inserts for 2206

EM-2205-1
without illustration
1 pair of silicone inserts for 2205
(old model)



EM-2204-1
MARKEL „S“
for small children / pair



EM-2204-2
MARKEL „M“
for children / pair

EM-2204-3
MARKEL „L“
for adults / pair



EM-2465-1
ORINGER
Selfretaining
cheek-lip retractor
small

EM-2465-2
ORINGER
medium

EM-2465-3
ORINGER
large



EM-2328-1
WIEDER
Tongue depressor
small

EM-2338-2
WIEDER
Tongue depressor
large



EM-2237
MOLT
12,0 cm
for children

EM-2237-1
1 pair of silicone inserts for 2237

EM-2338
MOLT
14,0 cm
for adults

EM-2338-1
1 pair of silicone inserts for 2238

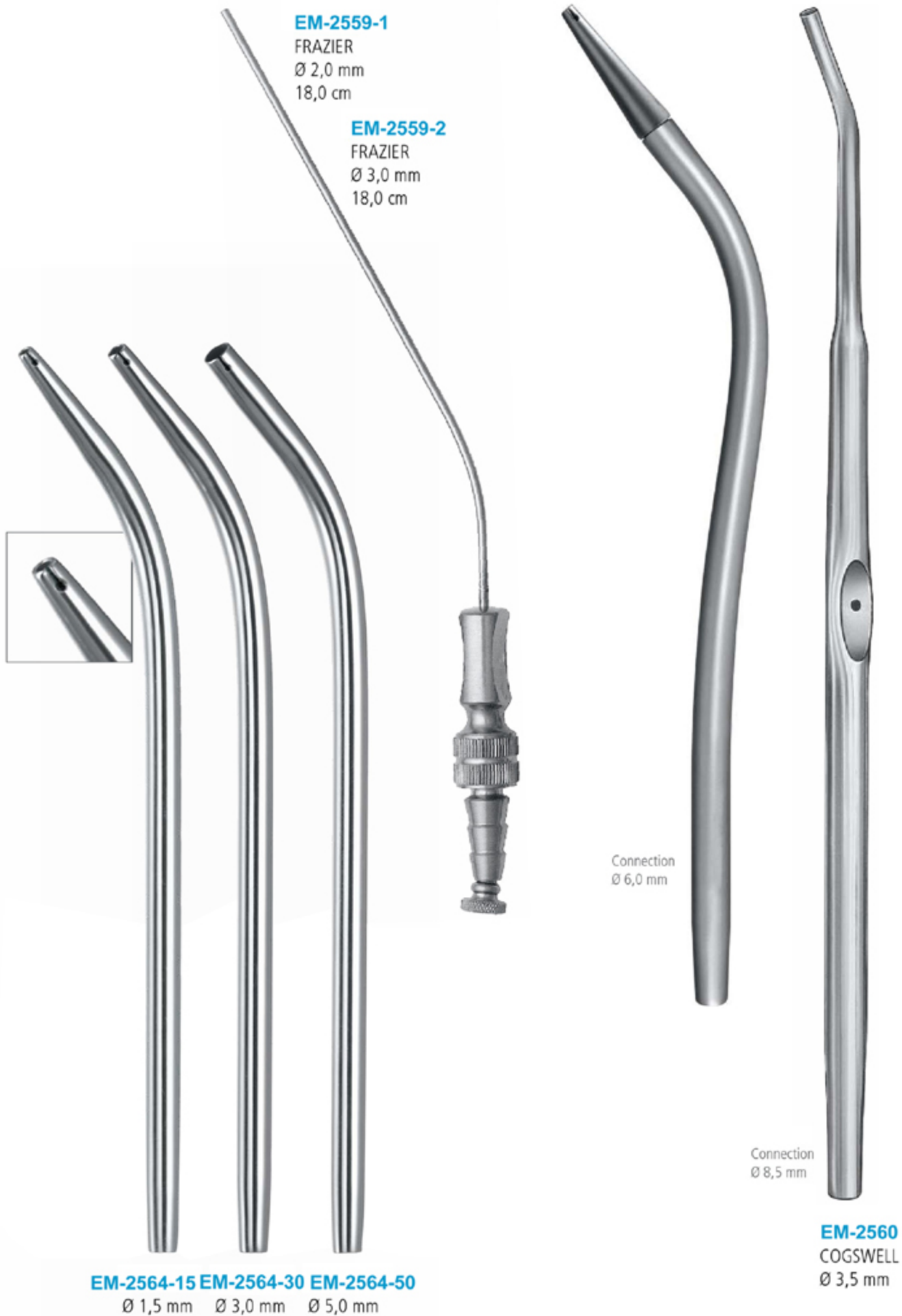



3/0 - 4/0



EM-2016-16
MAYO-HEGAR
16,0 cm



EM-2018-16
MAYO-HEGAR **TC**
16,0 cm



EM-2016-18
MAYO-HEGAR
18,0 cm



EM-2018-18
MAYO-HEGAR **TC**
16,0 cm

Suture size



3/0 - 4/0



EM-2012
CRILE-WOOD
15,0 cm



EM-2014
CRILE-WOOD **TC**
15,0 cm



EM-2011
BAUMGARTNER TC
13,0 cm

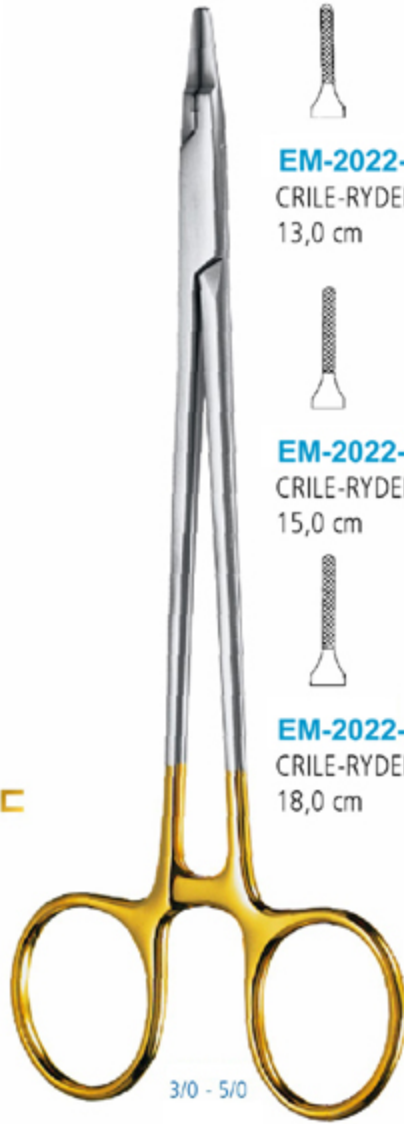

EM-2022-13
CRILE-RYDER TC
13,0 cm

EM-2022-15
CRILE-RYDER TC
15,0 cm

EM-2022-18
CRILE-RYDER TC
18,0 cm



EM-2052
MATHIEU
14,0 cm

EM-2053
MATHIEU
14,0 cm

EM-2057
MATHIEU TC
14,0 cm

3/0 - 4/0

3/0 - 5/0

3/0 - 4/0



3/0 - 4/0

Suture size



EM-2054
MATHIEU
17,0 cm



EM-2058
MATHIEU **TC**
17,0 cm



EM-2056
MATHIEU
17,0 cm



EM-2059
LICHTENBERG-
RYDER **TC**
14,0 cm



EM-2059-17
LICHTENBERG-
RYDER **TC**
17,0 cm



EM-2059-14
LICHTENBERG-
RYDER **TC**
14,0 cm



EM-2059-1
LICHTENBERG-
RYDER **TC**
17,0 cm

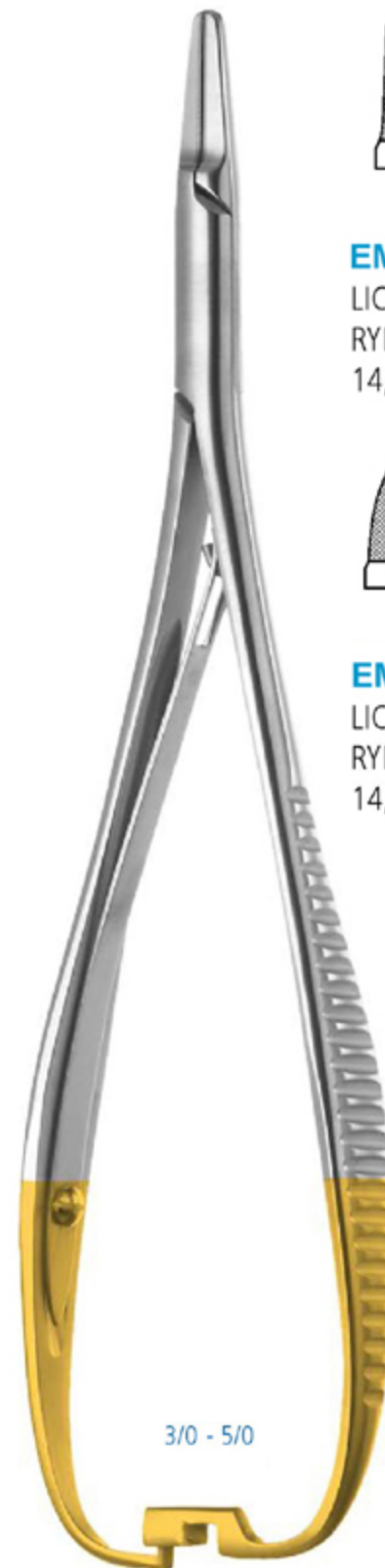

3/0 - 5/0



EM-2000-10

Micro Needleholder
with lock, 17,5 cm

5/0 - 8/0



EM-2000-16

Micro Needleholder
with lock, 17,5 cm

5/0 - 8/0



EM-2000-60

Micro Needleholder
with lock, 17,5 cm

4/0 - 8/0



EM-2000-66

Micro Needleholder
with lock, 17,5 cm



5/0 - 8/0

Suture size



EM-2001-1
CASTROVIEJO
14,0 cm



EM-2001-6
CASTROVIEJO
14,0 cm



EM-2007-51
CASTROVIEJO **TC**
with scissors
18,0 cm



EM-2002-1
CASTROVIEJO **TC**
14,0 cm



EM-2002-6
CASTROVIEJO **TC**
14,0 cm



EM-2002-16
CASTROVIEJO **TC**
with scissors
18,0 cm



5/0 - 8/0



EM-2002-1
MICRO **TC**
13,0 cm



EM-2002-6
MICRO **TC**
13,0 cm



5/0 - 8/0



EM-2000-51
MICRO **TC**
18,0 cm



EM-2000-56
MICRO **TC**
18,0 cm

 Diamond coating



6/0 - 8/0



EM-2000-201
BARRAQUER
18,0 cm



EM-2000-206
BARRAQUER
18,0 cm



EM-2000-21
BARRAQUER **TC**
18,0 cm



EM-2000-26
BARRAQUER **TC**
18,0 cm



3/0 - 4/0



EM-2035
TÖNNIS **TC**
18,0 cm





EM-2616-25
Medicine cup, 25 cm, stainless steel



EM-2640
100 cm
Fracture banding-splint with hooks



EM-2024
TC 15,0 cm
For wire ligatures



1:2 **EM-2619-2**
245 x 120 x 40 mm
Kidney bowl



EM-2666-18
1,8 cc
Metric thread
Without aspiration device

EM-2666-18US
1,8 cc
US - thread
Without aspiration device

EM-2666-22US
2,2 cc
US - thread
Without aspiration device



EM-2668-18
1,8 cc
Metric thread
With aspiration device

EM-2668-18US
1,8 cc
US - thread
With aspiration device

EM-2669-18
without illustration
1,8 cc
Metric thread
With 3 aspiration hooks



EM-2716
10,0 cc
Wasserspritze
Water syringe
aspirating

EM-2716
Spare canula



EM-1732
10,0 cm

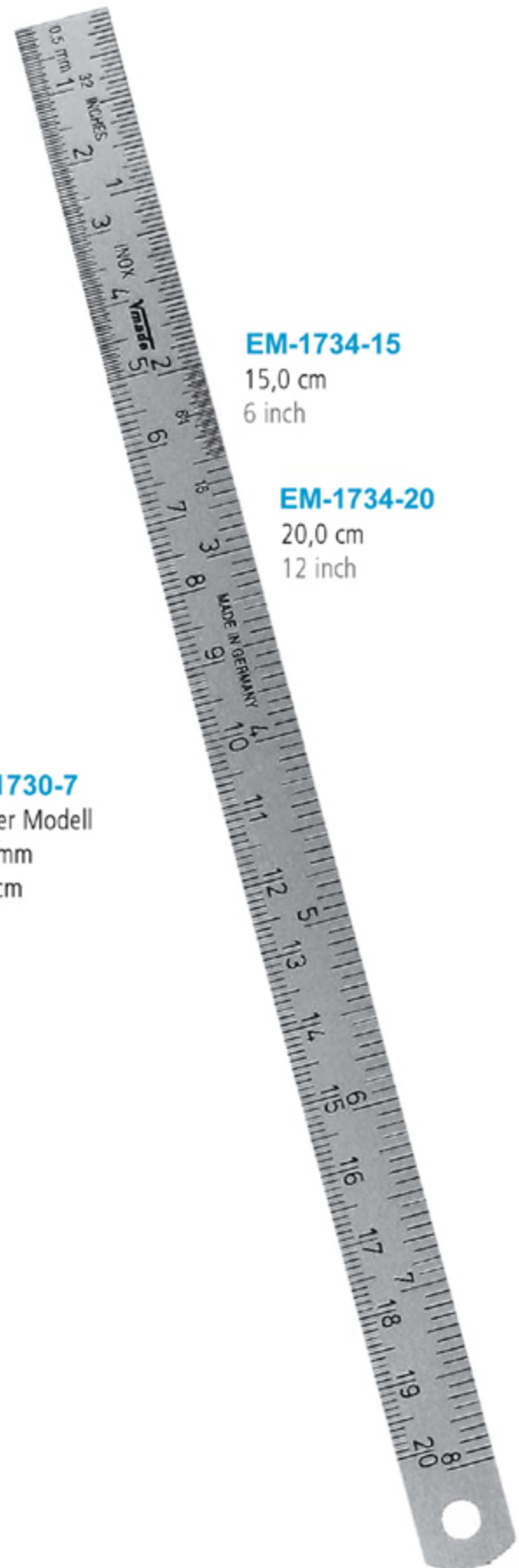

EM-1734-15
15,0 cm
6 inch

EM-1734-20
20,0 cm
12 inch

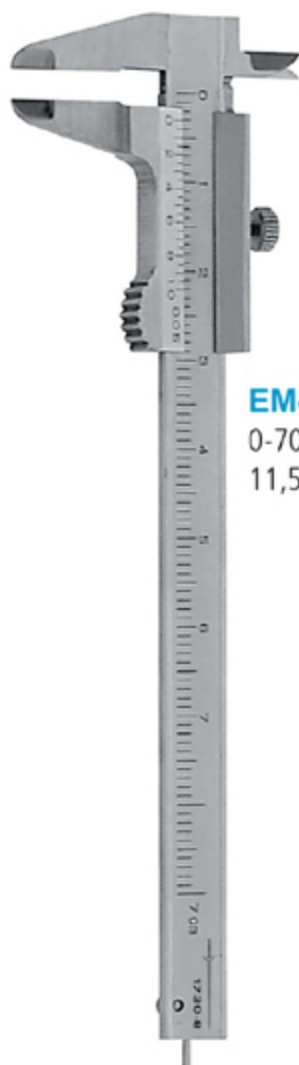

EM-1730-8
0-70 mm
11,5 cm

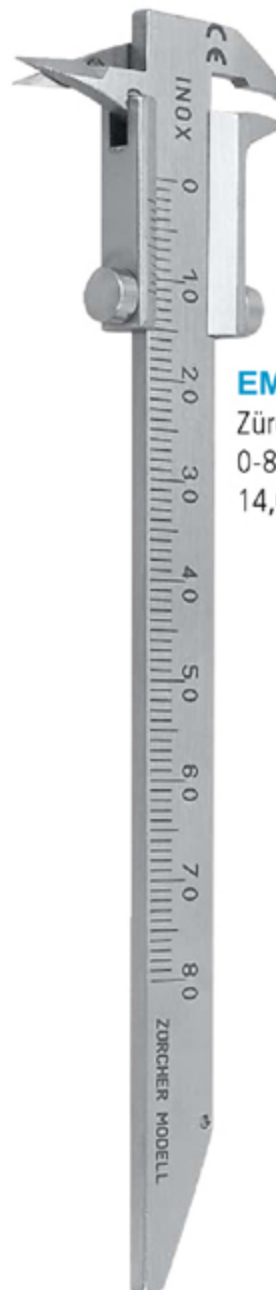

EM-1730-7
Zürcher Modell
0-80 mm
14,0 cm



4. Chirurgie · Surgery

Knochenmahlzange / Knochenquetsche · Bone mill forceps / Bone crusher

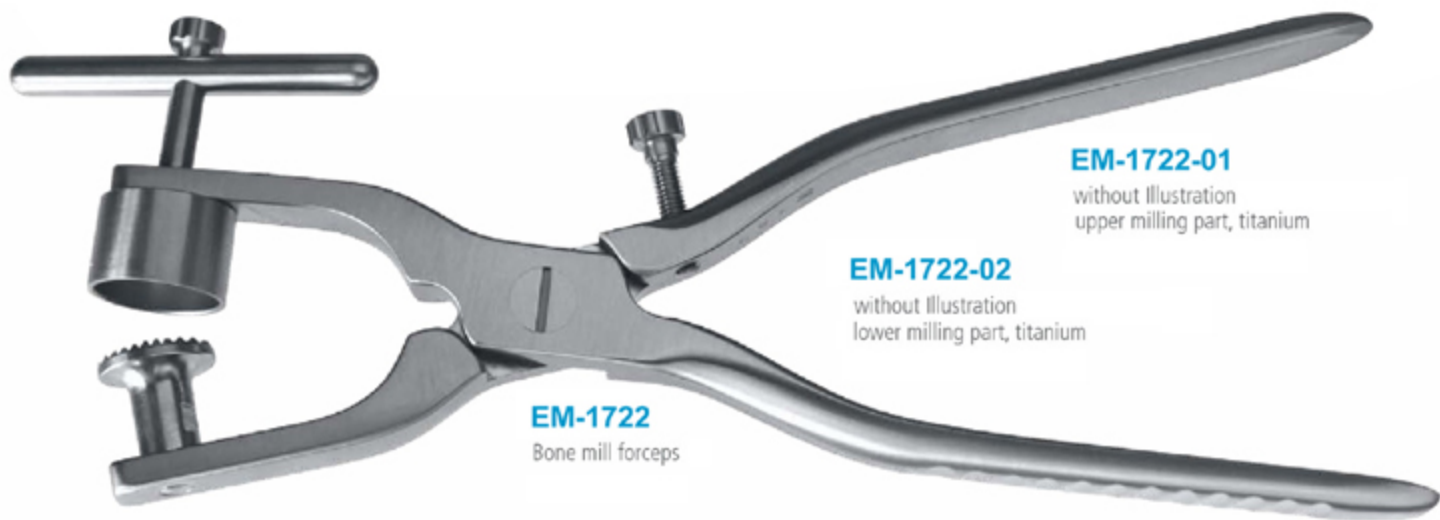

EM-1722-01
without illustration
upper milling part, titanium

EM-1722-02
without illustration
lower milling part, titanium

EM-1722
Bone mill forceps



EM-1724
Bone crusher



4. Chirurgie • Surgery

Knochenschaber • Bone scraper



EM-1723-1
15,5 cm
straight



EM-1723-11
Spare blade

TiN coated blades,
extra sharp and durable



EM-1723-16 **EM-1723-6**
Spare blade 15,5 cm
curved



EM-1435-5
17,6 cm
Spoon instrument