



Scissors

Schere



Flat handles and cross serration:
 Provides a solid grip.

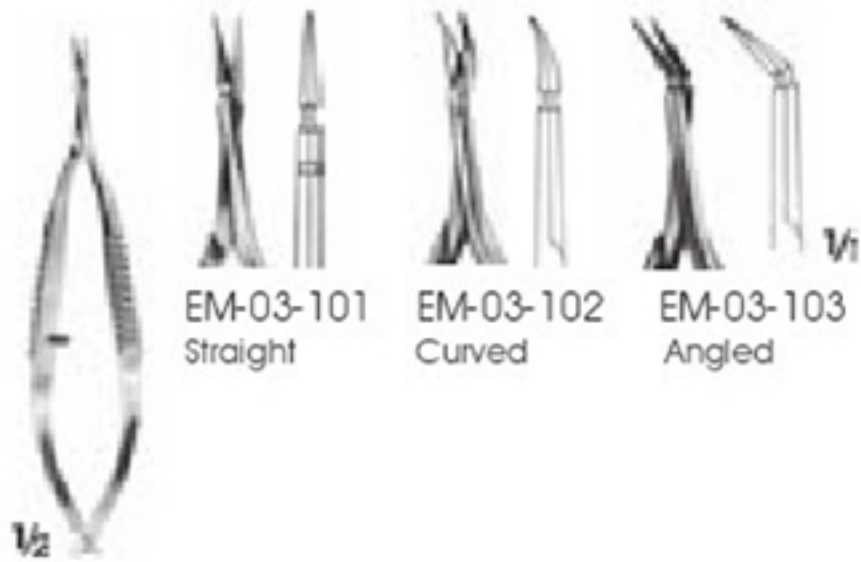

EM-03-101 Straight
 EM-03-102 Curved
 EM-03-103 Angled

$\frac{1}{2}$
 VANNAS
 EM-03-101 - 103
 Delicate
 8.5 cm

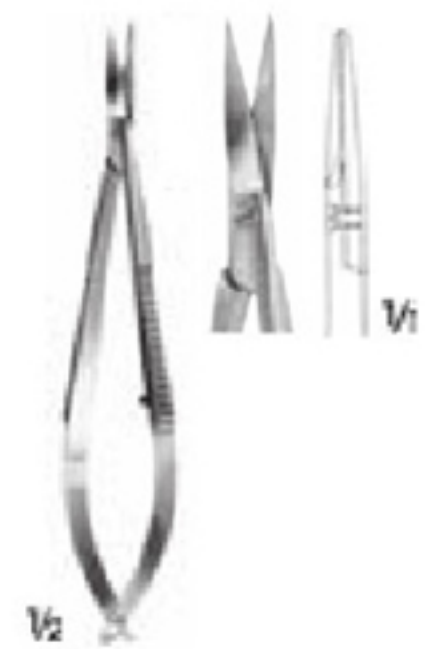

$\frac{1}{2}$
 MC CLURE
 EM-03-104
 Straight
 Eye scissors
 9.5 cm

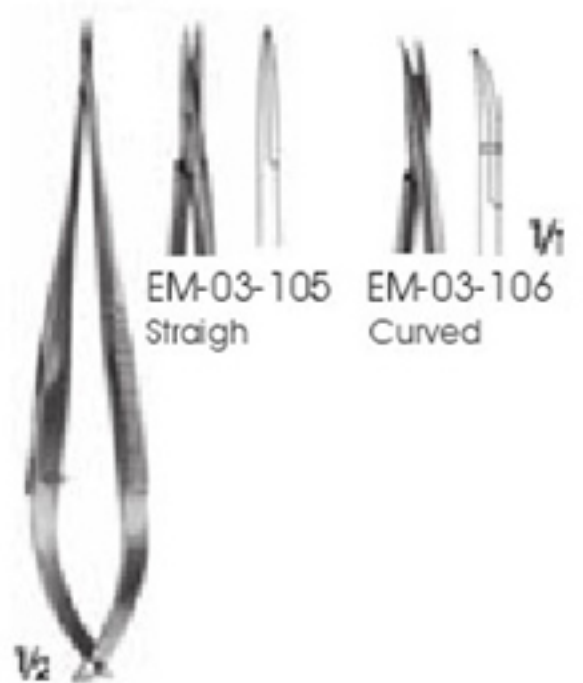

$\frac{1}{2}$
 EM-03-105 - 106
 Eye scissors
 10.5 cm

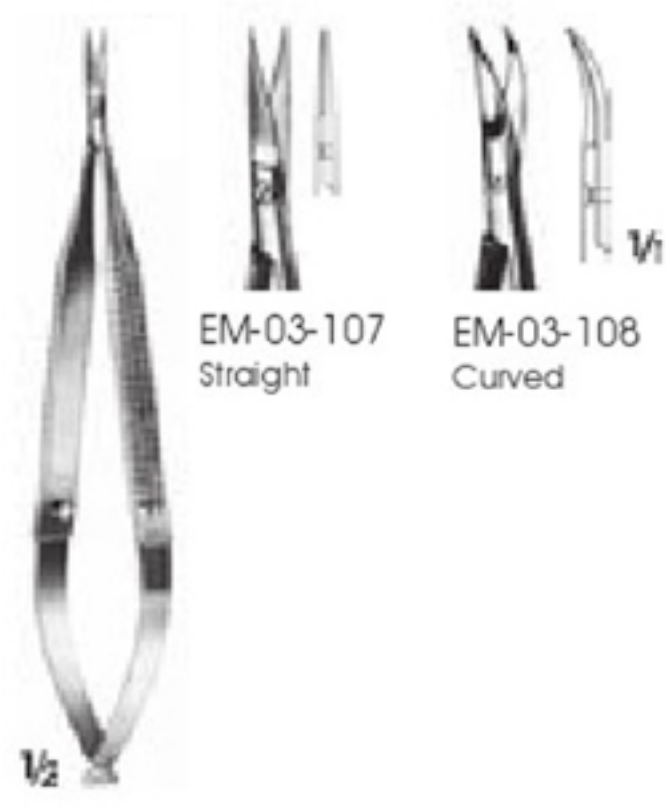

EM-03-107 Straight
 EM-03-108 Curved

$\frac{1}{2}$
 EM-03-107 - 108
 Micro scissors
 12 cm



$\frac{1}{2}$
 VANNAS
 EM-03-109
 Straight
 Micro scissors
 12 cm



$\frac{1}{2}$
 VANNAS
 EM-03-110
 Micro scissors
 12 cm

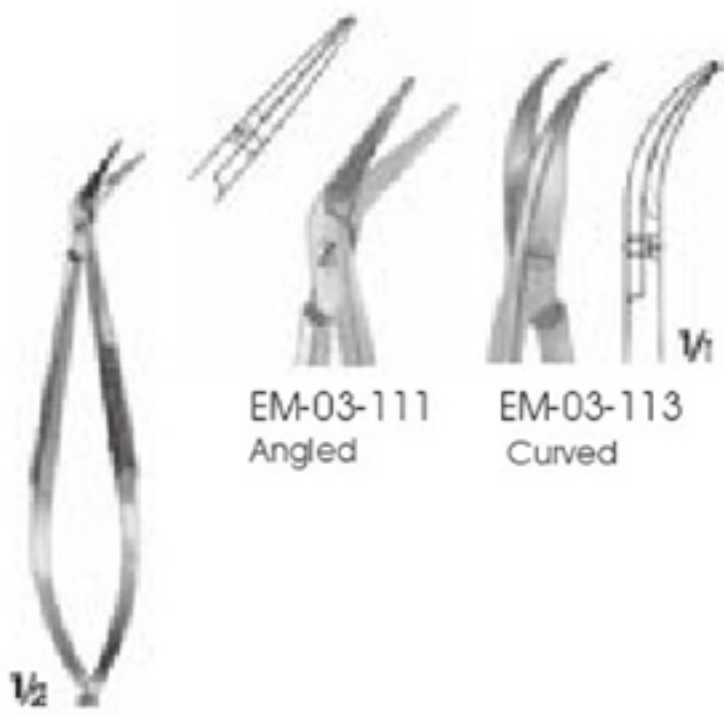

CASTROVIEJO
 EM-03-111 - 113
 Eye Scissors
 9.5 cm

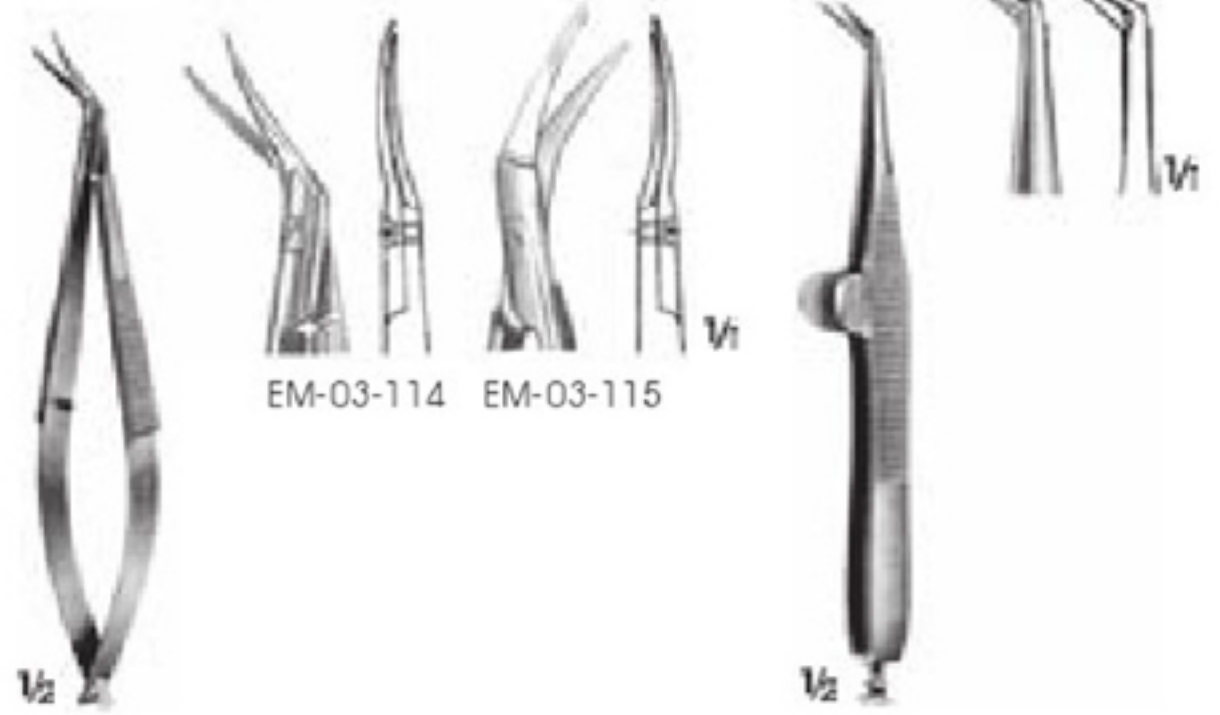

CASTROVIEJO
 EM-03-114 - 115
 Eye scissors
 11 cm

WECKER
 EM-03-116 Pointed-pointed
 EM-03-117 Pointed-blunt, right
 EM-03-118 Pointed-blunt, left
 EM-03-119 Blunt-blunt
 Eye scissors
 11 cm

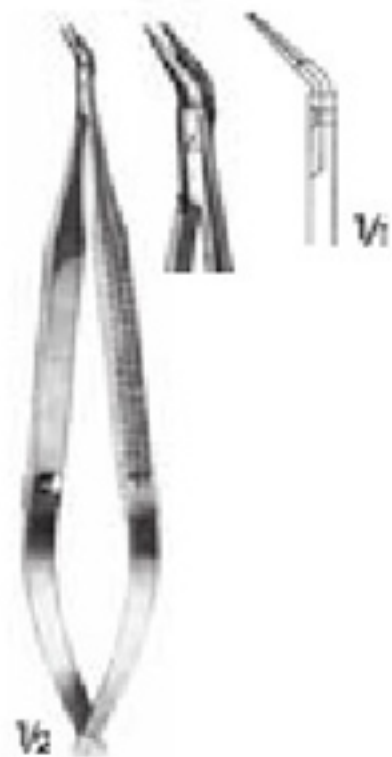

VANNAS
 EM-03-120
 Micro scissors
 Angled on flat
 12 cm



NOYES
 EM-03-121
 Eye scissors
 Straight
 12.5 cm



EM-03-122
 Vein scissors for roughening
 Vessel ends
 13 cm



Flat handles and cross serration:
 Provides a solid grip.



EM-03-123 - 124
 16 cm

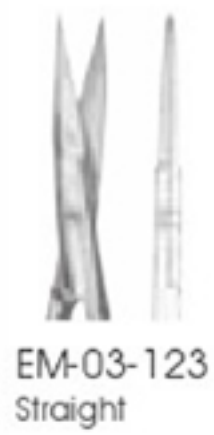

EM-03-123
 Straight

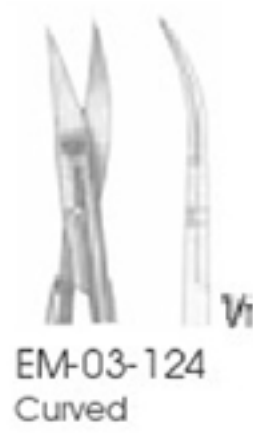

EM-03-124
 Curved



VANNAS
 EM-03-125 - 126
 16 cm



EM-03-125
 Straight

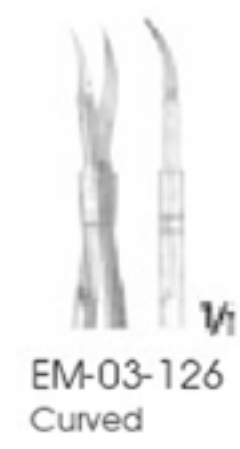

EM-03-126
 Curved



MILLESI
 EM-03-127 - 128
 Both jaws serrated
 16 cm



EM-03-127
 Straight

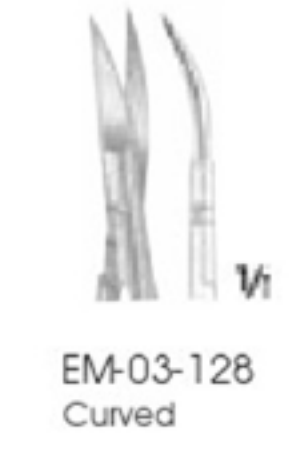

EM-03-128
 Curved



EM-03-129 - 130
 18.5 cm



YASARGIL
 EM-03-129
 Straight

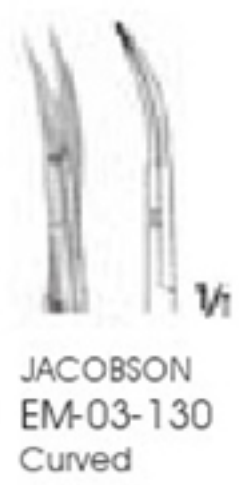

JACOBSON
 EM-03-130
 Curved



EM-03-131-01 - 131-02
 Straight
 16.5 cm



EM-03-131-01
 Ultra delicate blade



EM-03-131-02
 Delicate blade



EM-03-132-01 - 132-02
 Curved
 16.5 cm



EM-03-132-01
 Ultra delicate blade



EM-03-132-02
 Delicate blade



Round Handle

- Allows rotation between the fingers as required
- Due to carved and strong handle, each instrument provides optimum balance.

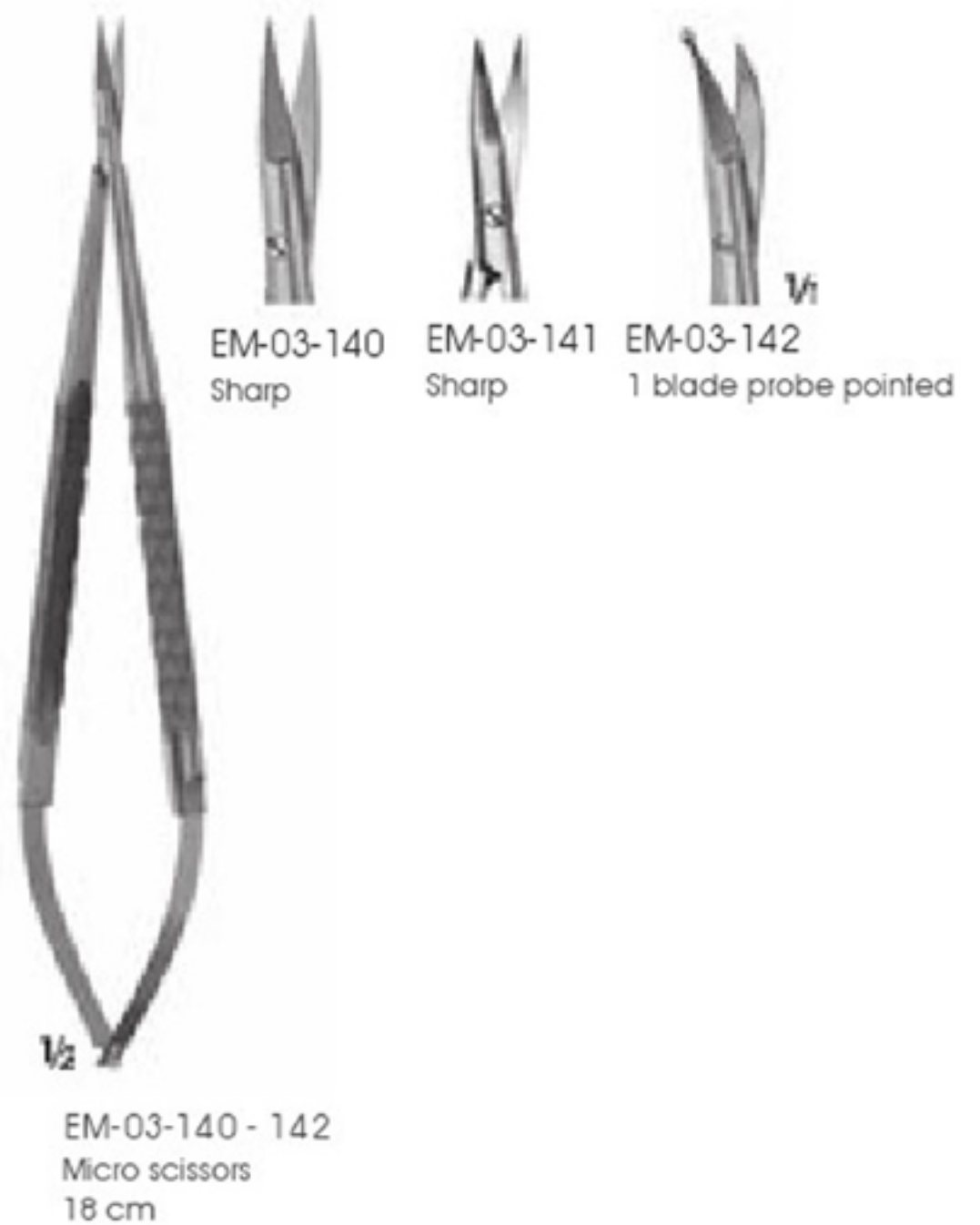
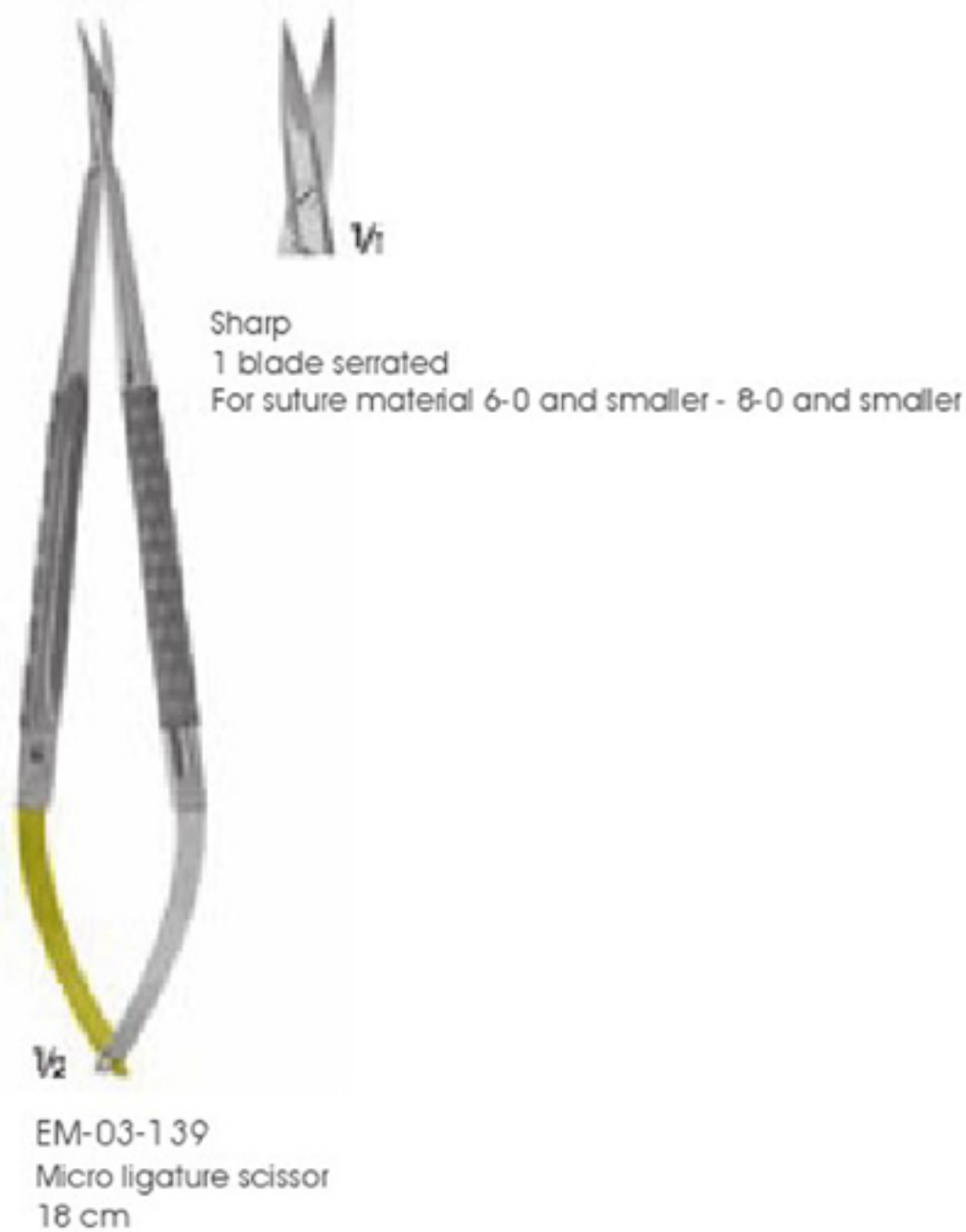
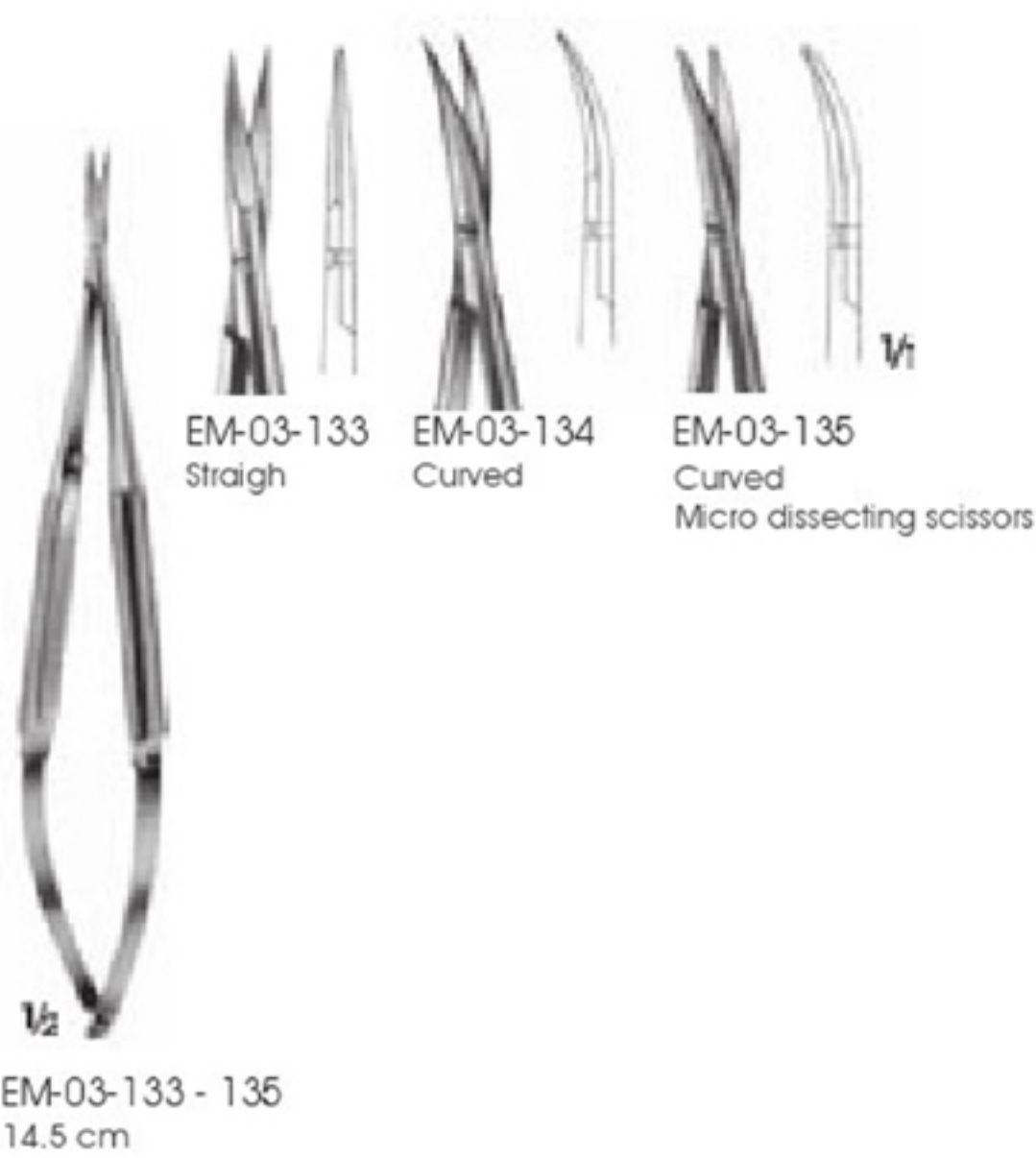



25° 45° 60° 90° 125°

Ultra delicate blade



EM-03-143-01 EM-03-143-02 EM-03-143-03 EM-03-143-04 EM-03-143-05
 EM-03-144-01 EM-03-144-02 EM-03-144-03 EM-03-144-04 EM-03-144-05

Delicate blade



EM-03-143-06 EM-03-143-07 EM-03-143-08 EM-03-143-09 EM-03-143-10
 EM-03-144-06 EM-03-144-07 EM-03-144-08 EM-03-144-09 EM-03-144-10

Fine blade,
 with 1 probe pointed blade

Flat handle Round handle



EM-03-143-11 EM-03-143-12 EM-03-143-13 EM-03-143-14 EM-03-143-15
 EM-03-144-11 EM-03-144-12 EM-03-144-13 EM-03-144-14 EM-03-144-15

Fine blade



EM-03-143-16 EM-03-143-17 EM-03-143-18 EM-03-143-19 EM-03-143-20
 EM-03-144-16 EM-03-144-17 EM-03-144-18 EM-03-144-19 EM-03-144-20

EM-03-143-01 - 144-20 EM-03-144-01 - 177-20
 16.5 cm 16.5 cm

Lightweigh plastic handles to increase grip surface :

- Provides cramp free, natural holding positions and sensitivity
- Round cross-section of the instrument provides an easy and smooth rotation. Expands the working and application area.
- Retention profile with pin ensures safe gripping.
- Ergonomic, light weight plastic handle provides fatigue free, optimal usage.

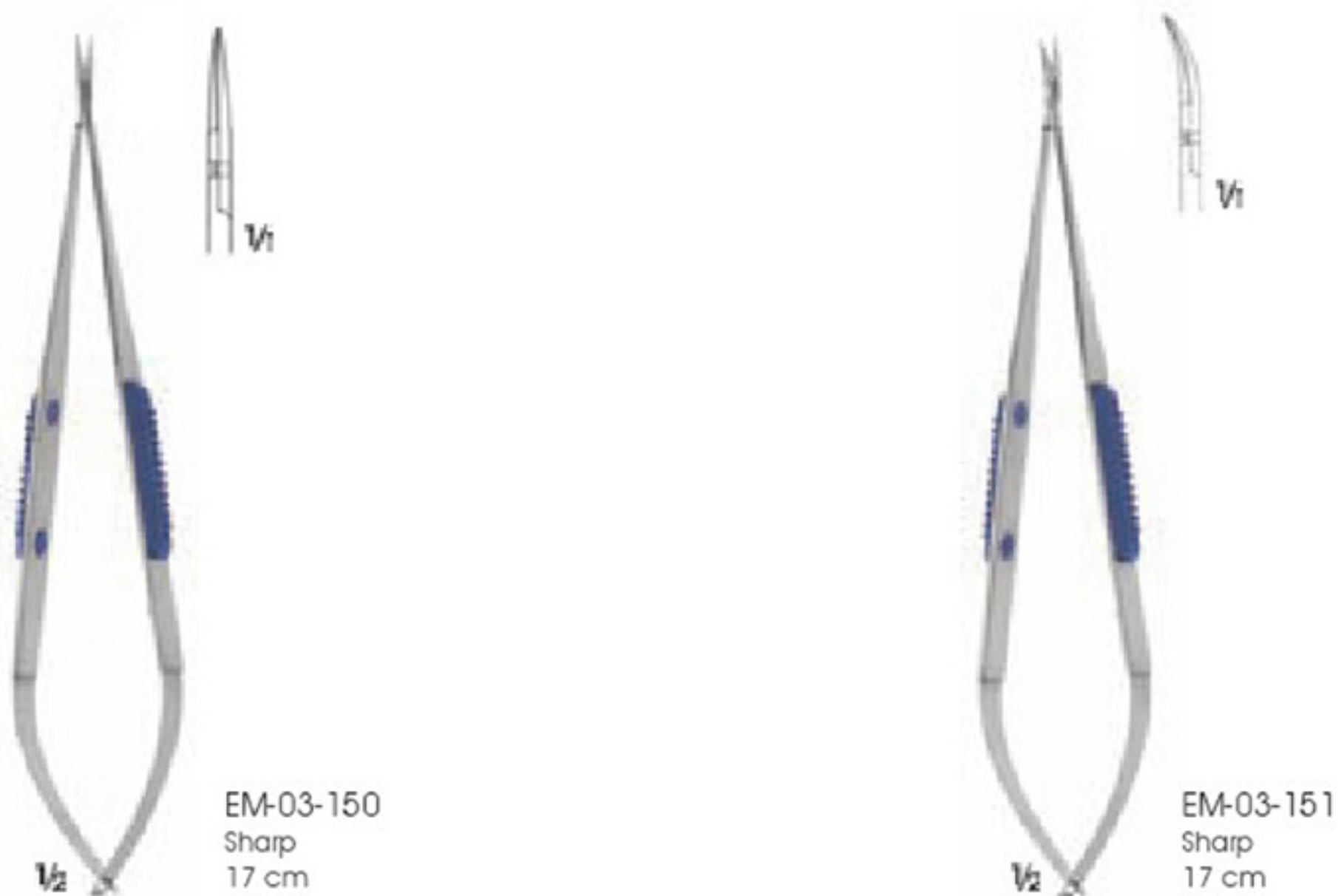

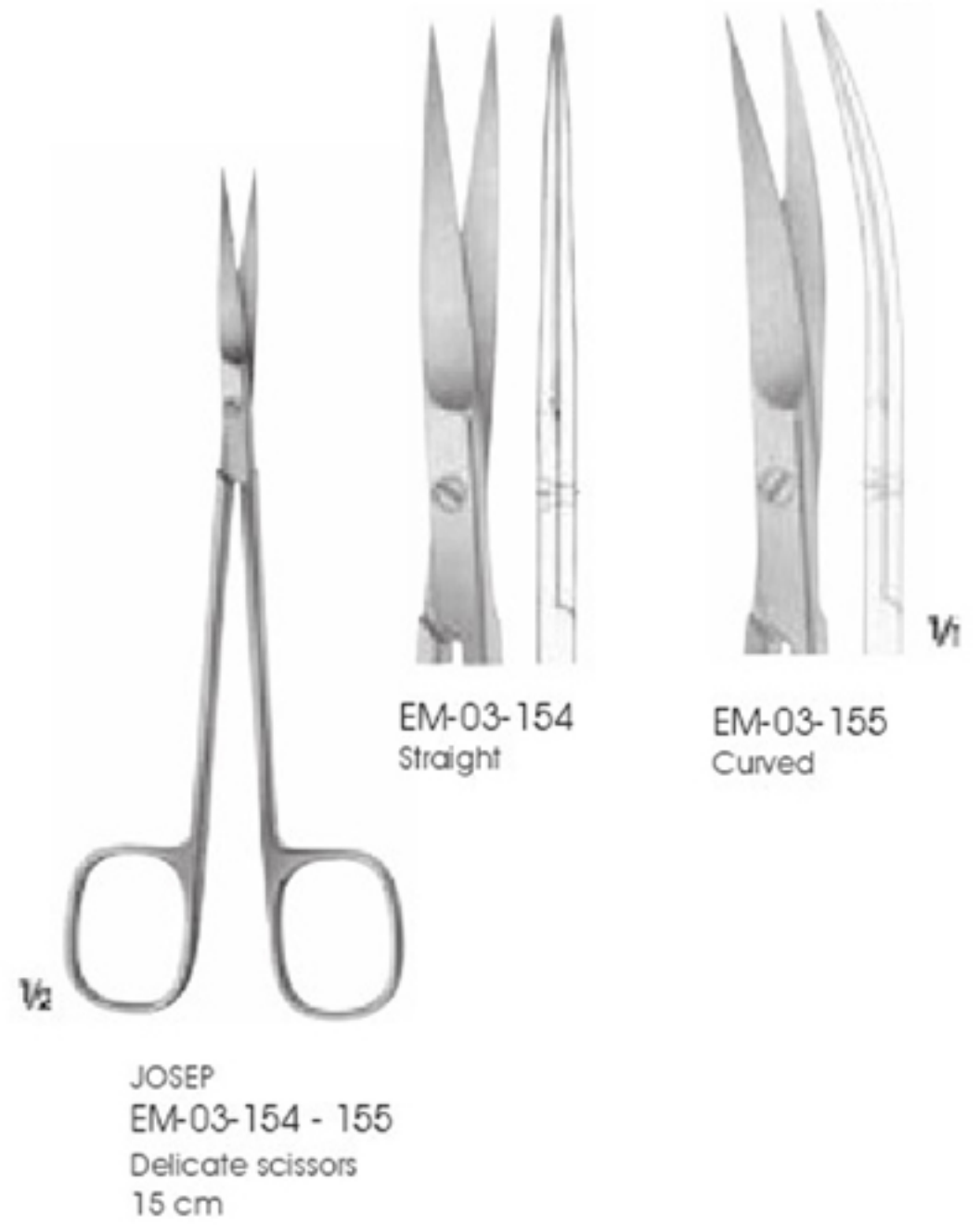

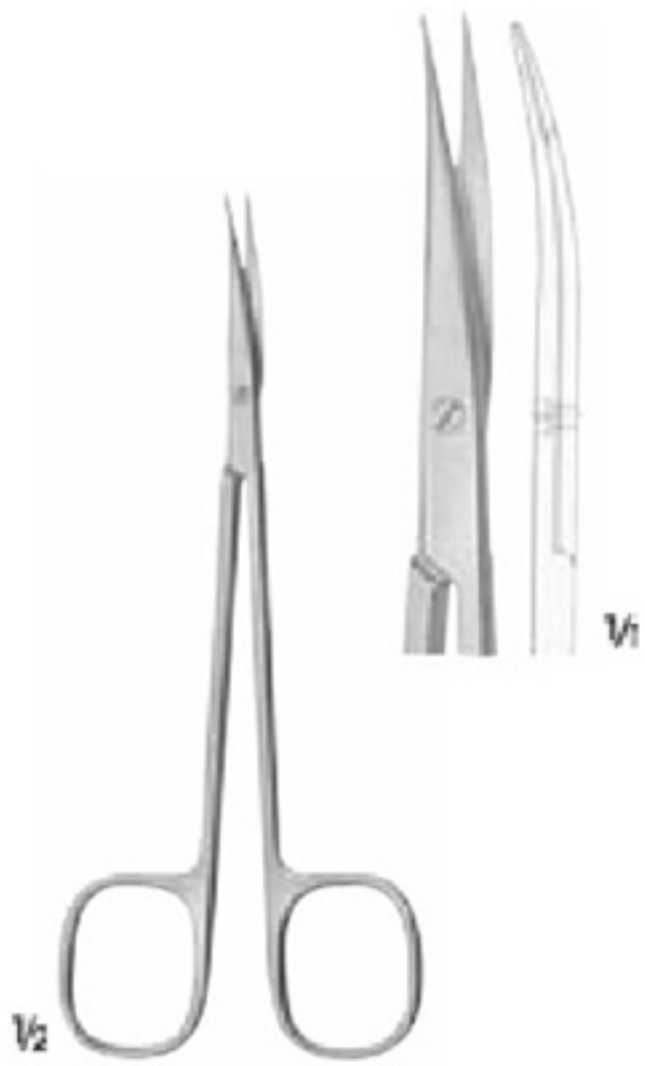

REYNOLDS-JAMESON
 EM-03-162
 Vascular scissors
 14 cm



EM-03-163
 Straight

EM-03-164
 Curved

METZENBAUM
 EM-03-163 - 164
 Dissecting scissors
 14.5 cm

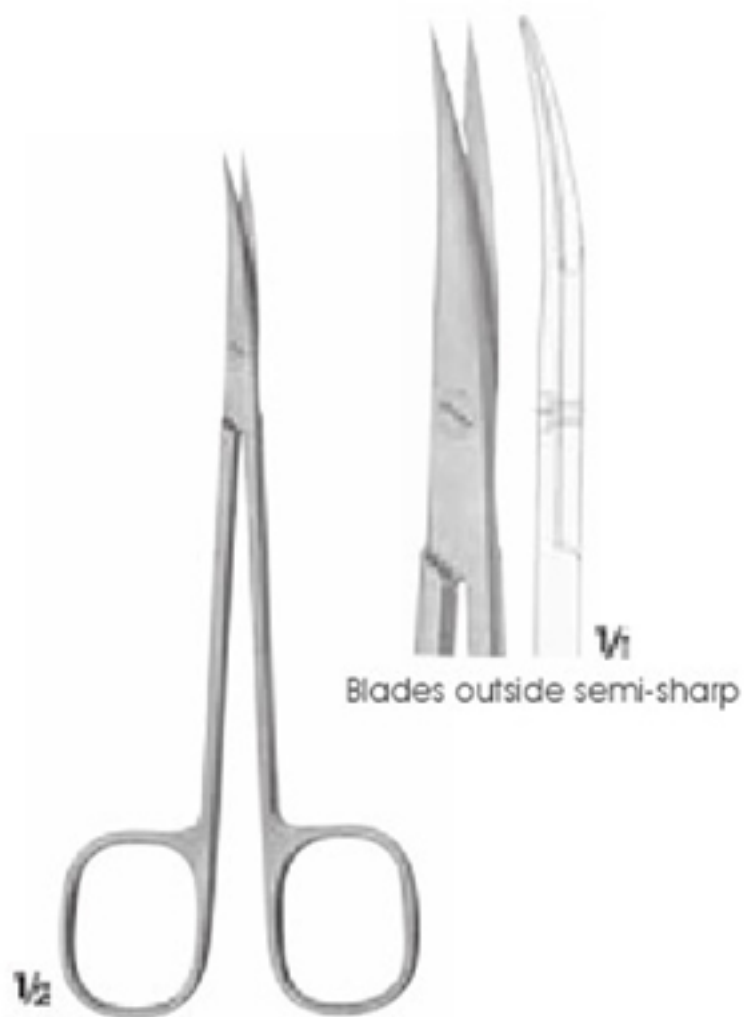

EM-03-165
 Nerve dissecting scissors
 14 cm



EM-03-166
 Straight
 13.5 cm

EM-03-167
 Curved
 13.5 cm

EM-03-168
 Curved
 15 cm

RAGNELL
 EM-03-166 - 168
 Special flat points for dissecting and
 undermining the skin

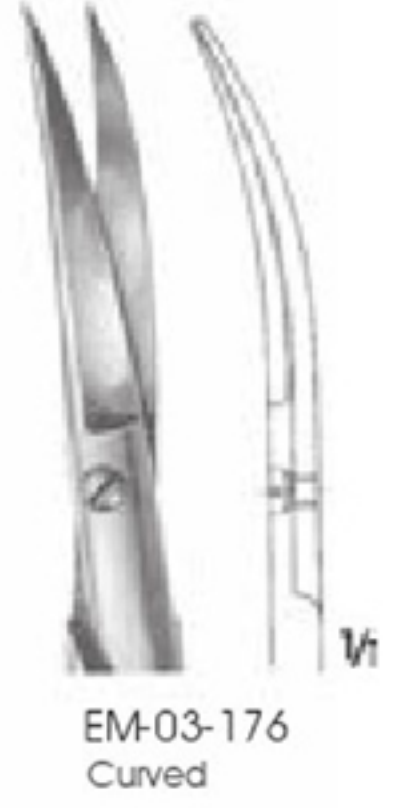
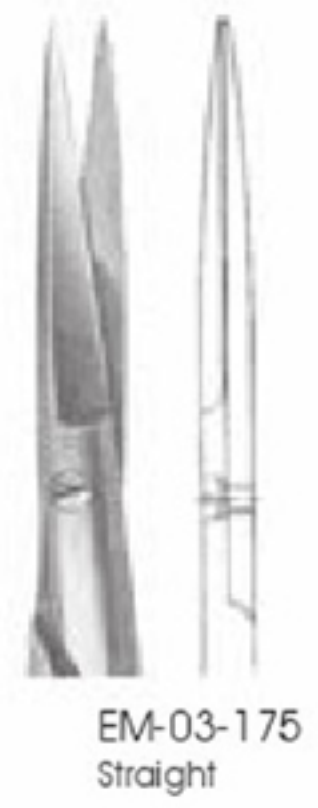
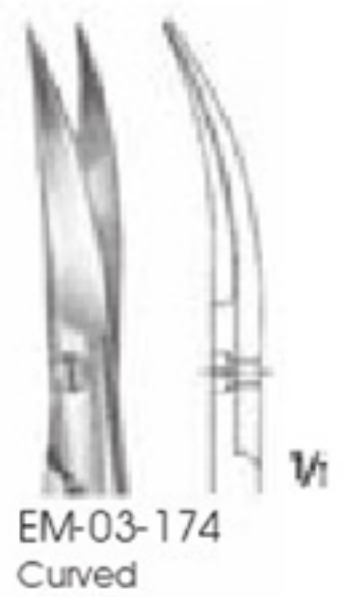
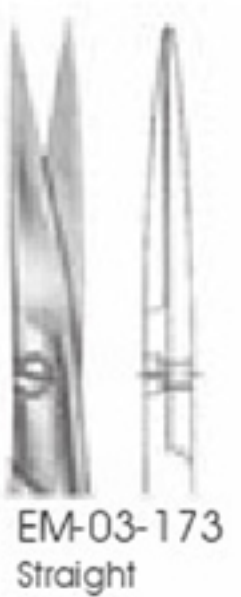
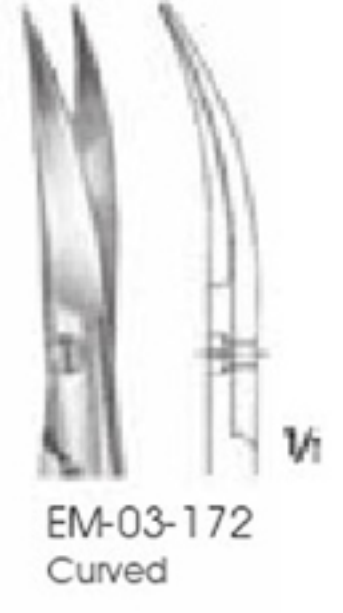
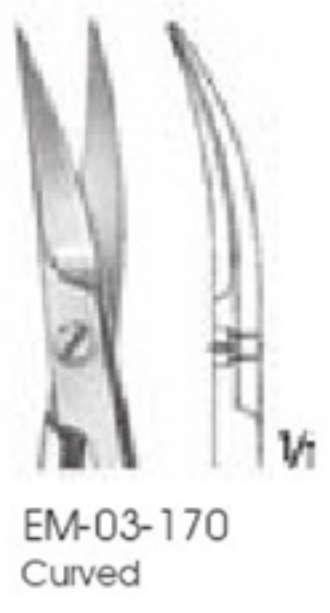



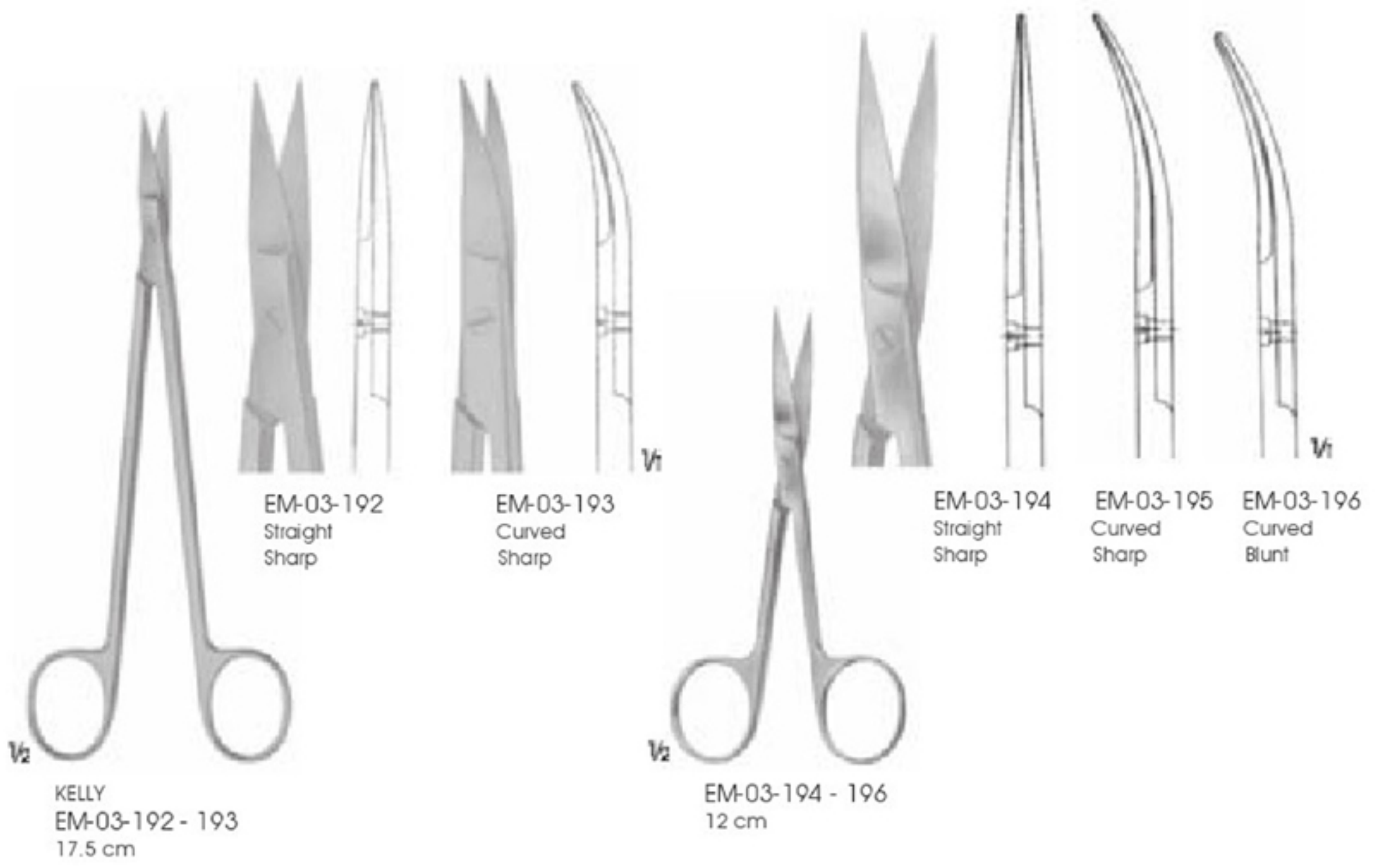

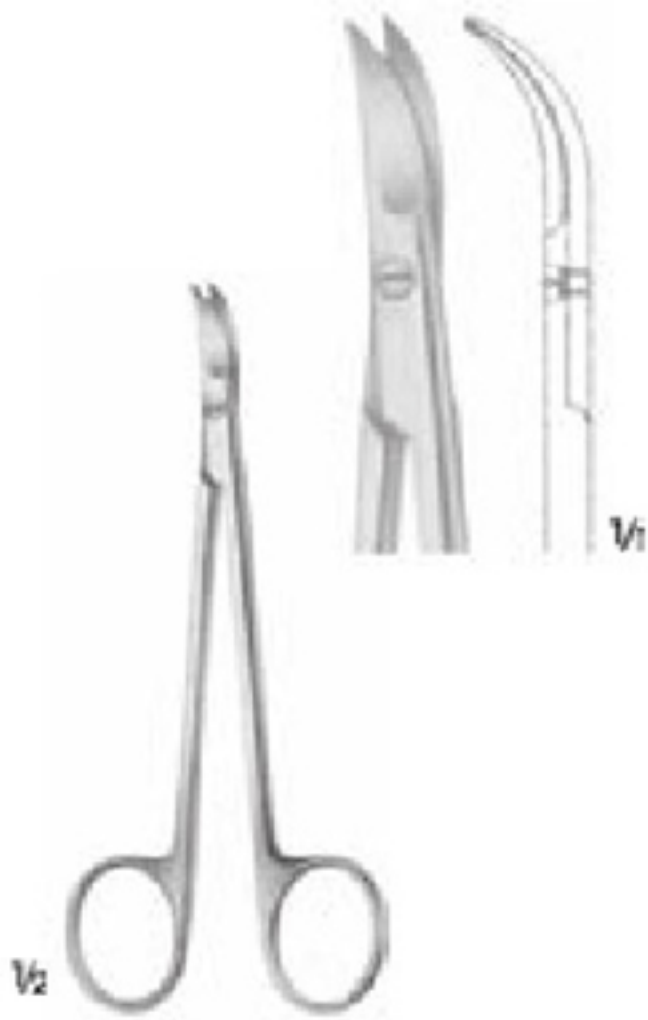

CHADWICK
EM-03-197
11.5 cm

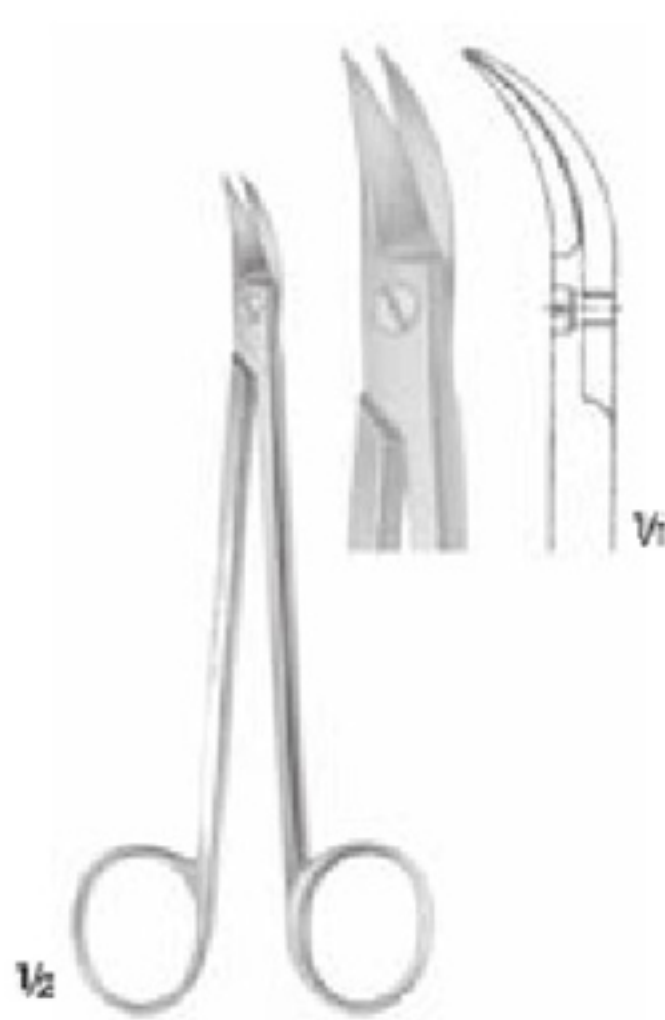

QUINBY
EM-03-198
13 cm

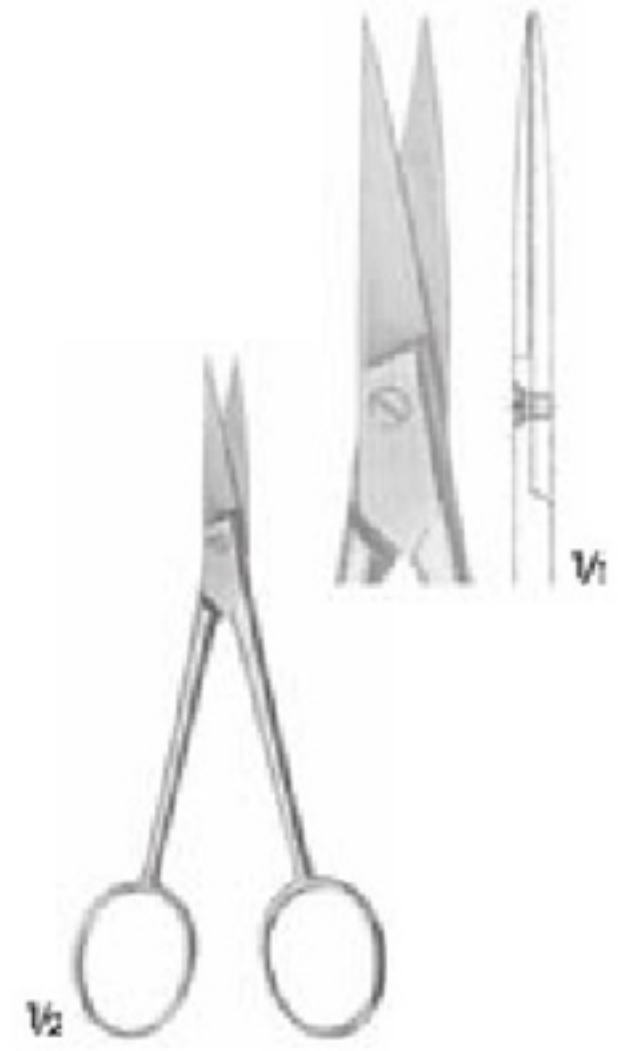

EM-03-199
11 cm

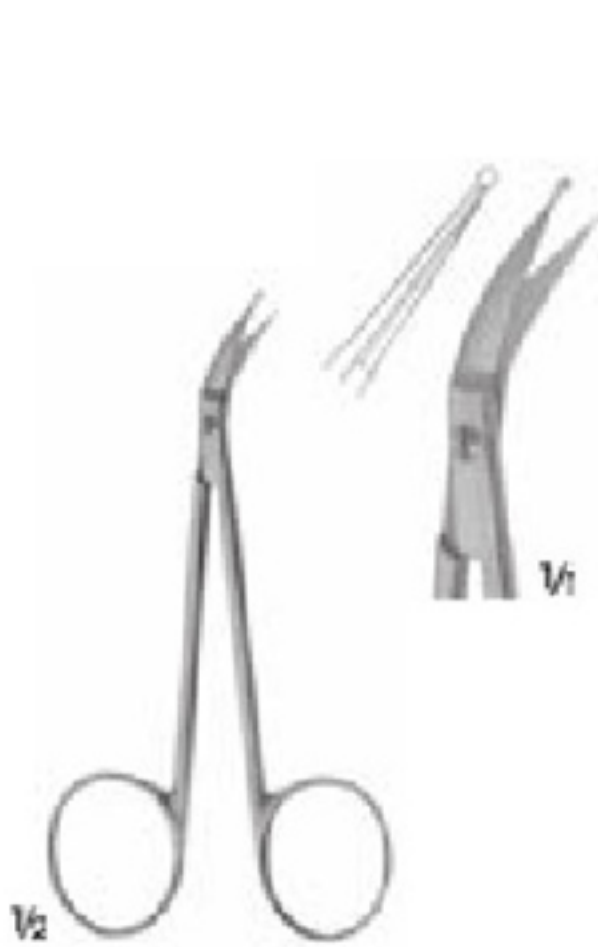

PERWITSCHKY
EM-03-200
With 1 probe pointed blade, curved to side
10 cm



EM-03-201
Angled to side
11.5 cm

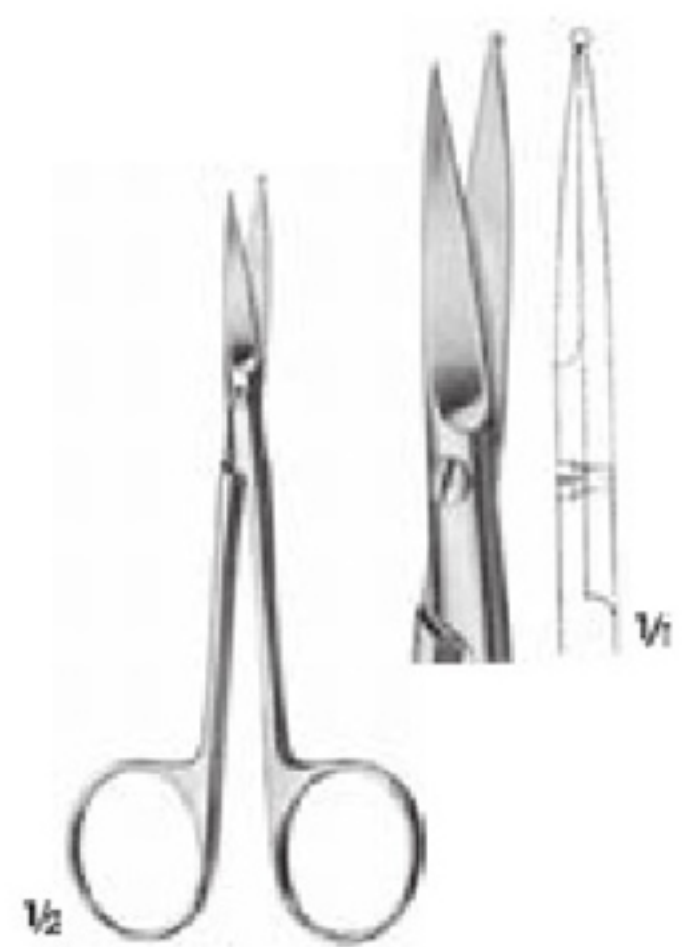

EM-03-202
With 1 probe pointed blade
12 cm

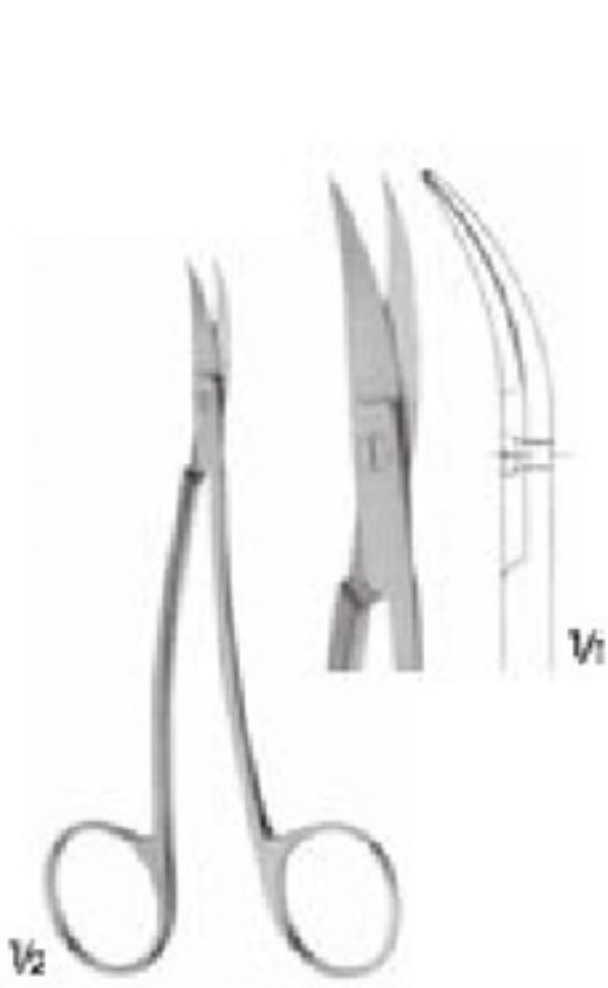

LA GRANGE
EM-03-203
One jaw serrated
11 cm



EM-03-204
Angled on flat, one jaw serrated
12.5 cm

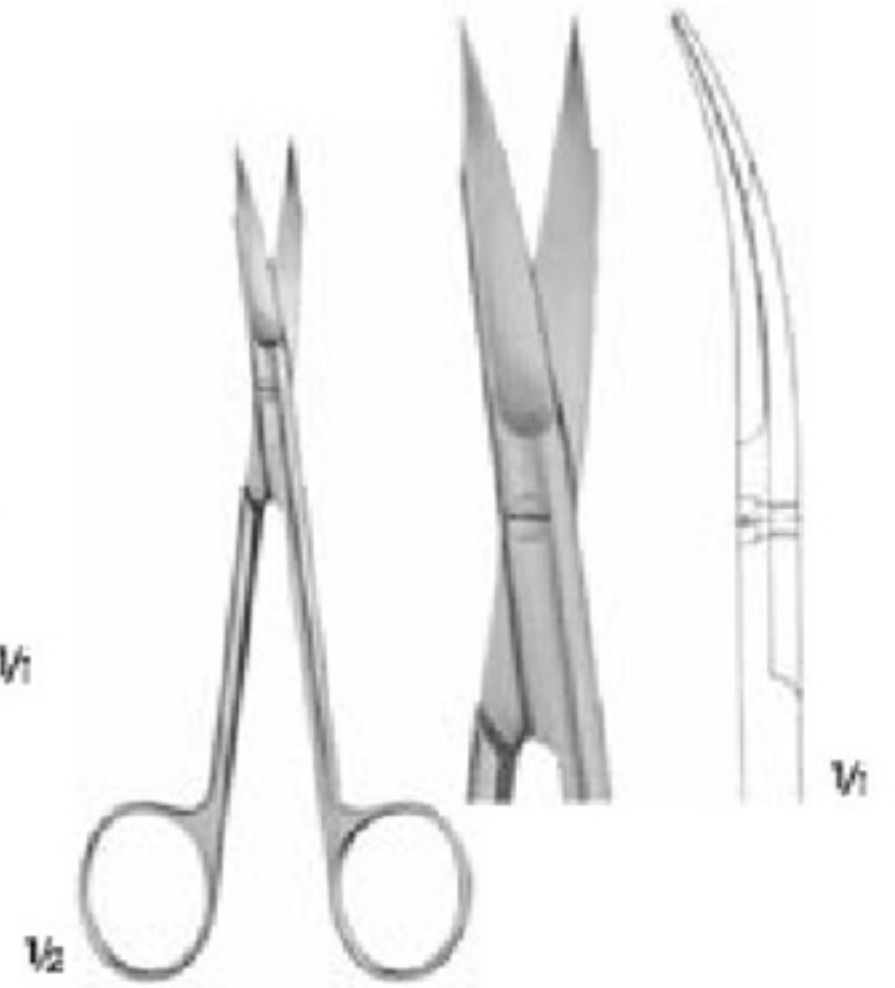

EM-03-205
One jaw fine serrated
13 cm

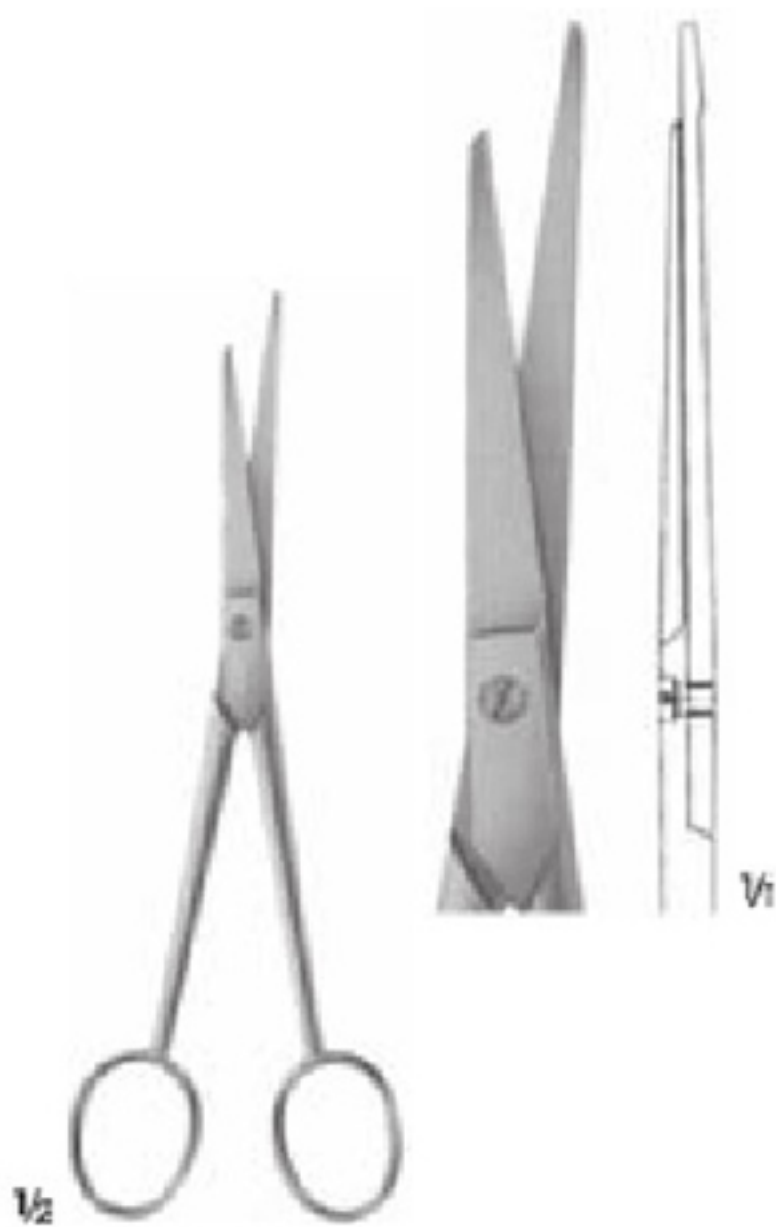

EM-03-206
With 1 probe pointed blade
14.5 cm



LOCKLIN
EM-03-207
Angled to side, one jaw serrated
15.5 cm

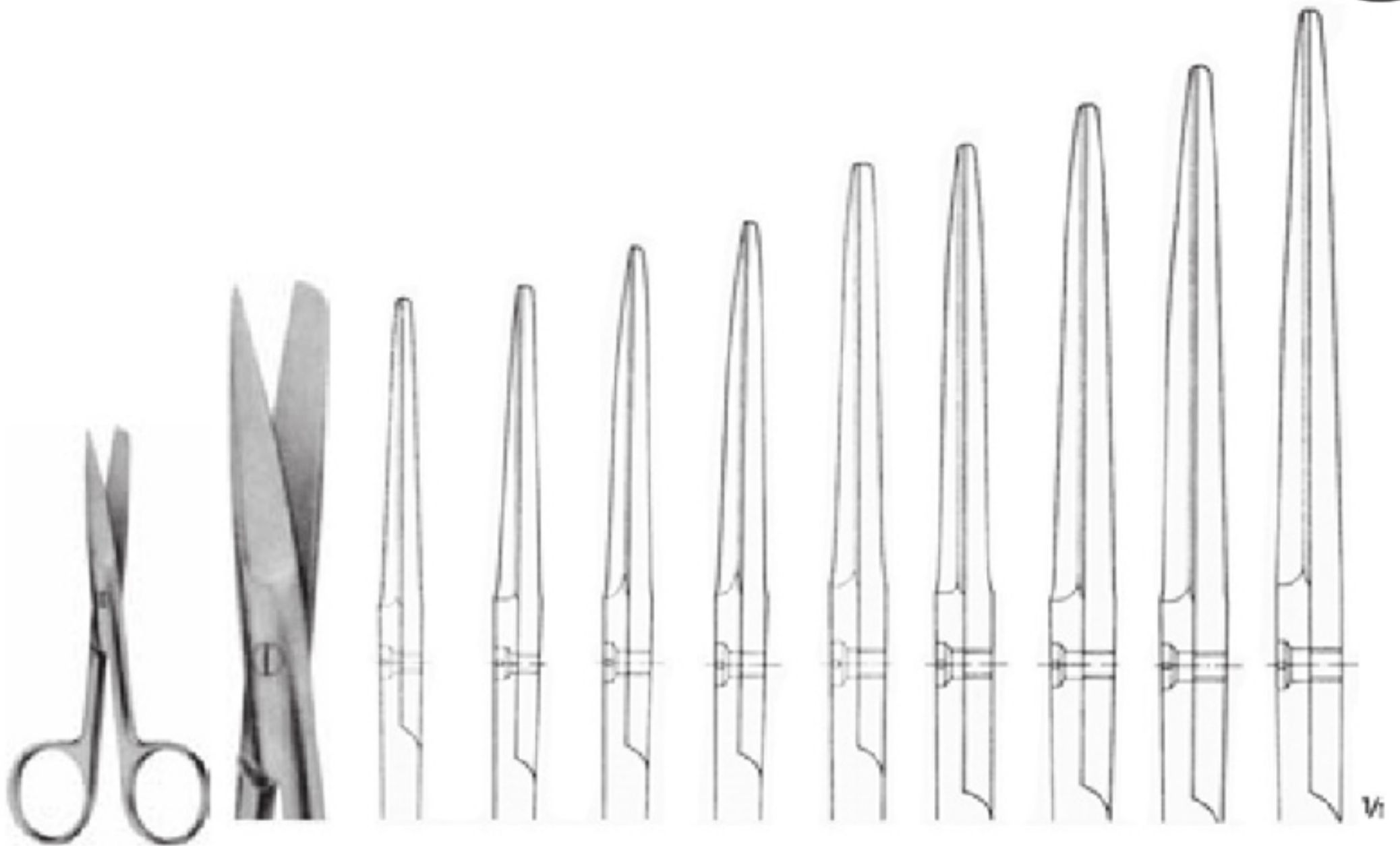

EM-03-208-01 10.5 cm
EM-03-208-02 11.5 cm
EM-03-208-03 13 cm
EM-03-208-04 14.5 cm
EM-03-208-05 15 cm
EM-03-208-06 16.5 cm
EM-03-208-07 17.5 cm
EM-03-208-08 18.5 cm
EM-03-208-09 20 cm

EM-03-208-01 - 208-09
Standart patterns
Sharp-Blunt
Straight

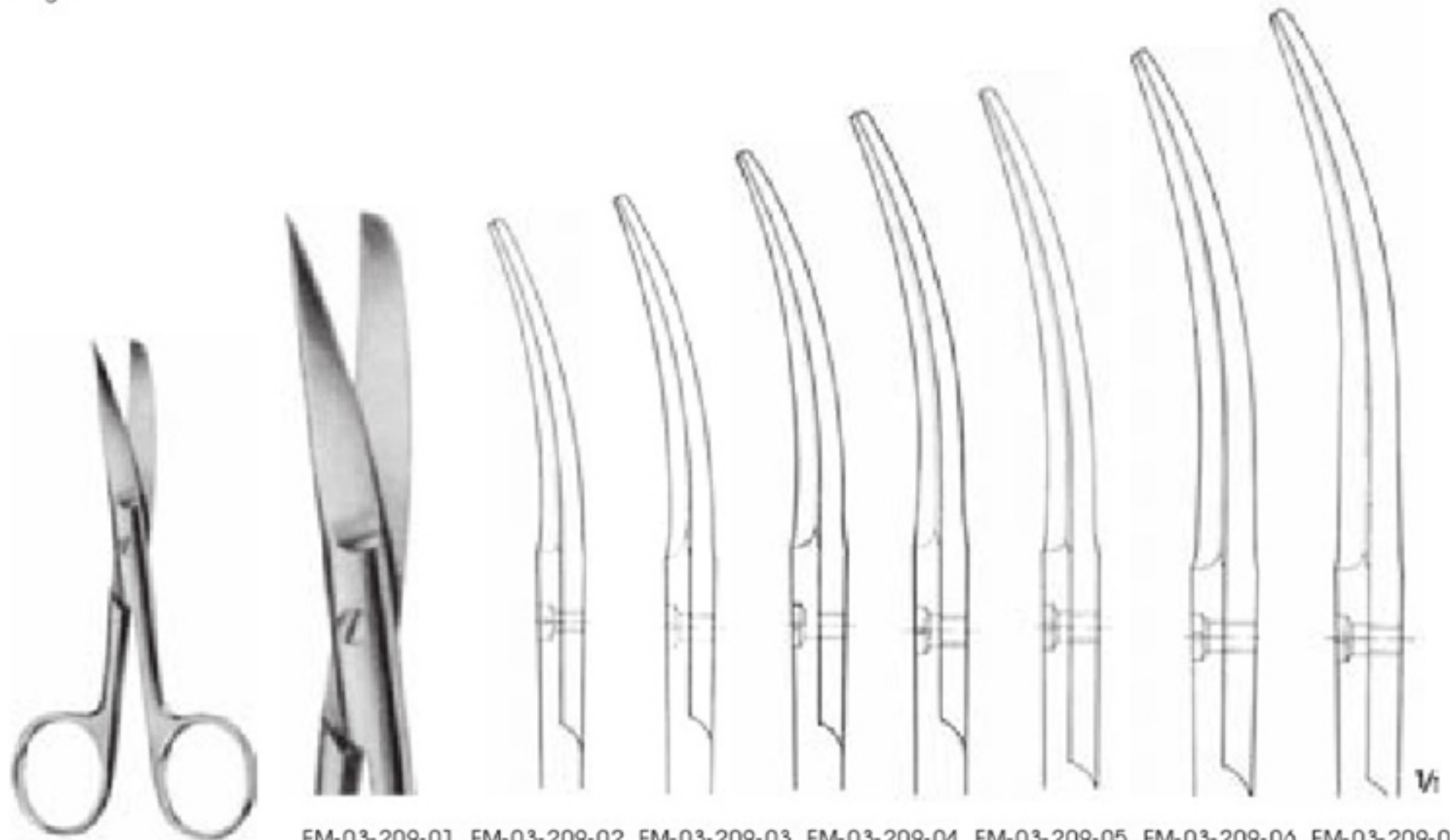

EM-03-209-01 11.5 cm
EM-03-209-02 13 cm
EM-03-209-03 14.5 cm
EM-03-209-04 15 cm
EM-03-209-05 16.5 cm
EM-03-209-06 17.5 cm
EM-03-209-07 18.5 cm

EM-03-209-01 - 209-07
Standart patterns
Sharp-Blunt
Curved

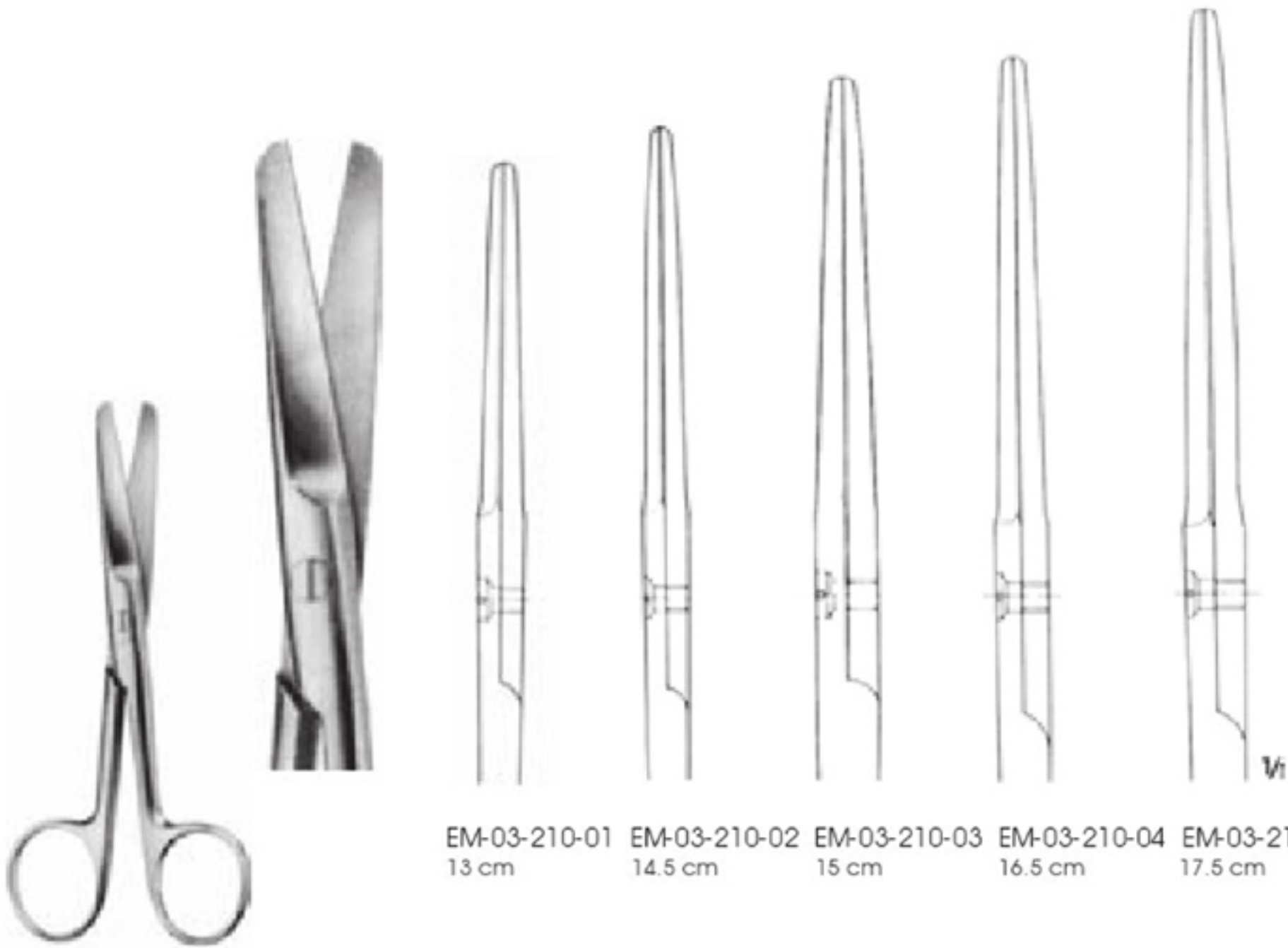

EM-03-210-01 13 cm
EM-03-210-02 14.5 cm
EM-03-210-03 15 cm
EM-03-210-04 16.5 cm
EM-03-210-05 17.5 cm

EM-03-210-01 - 210-05
Standart patterns
Blunt
Straight

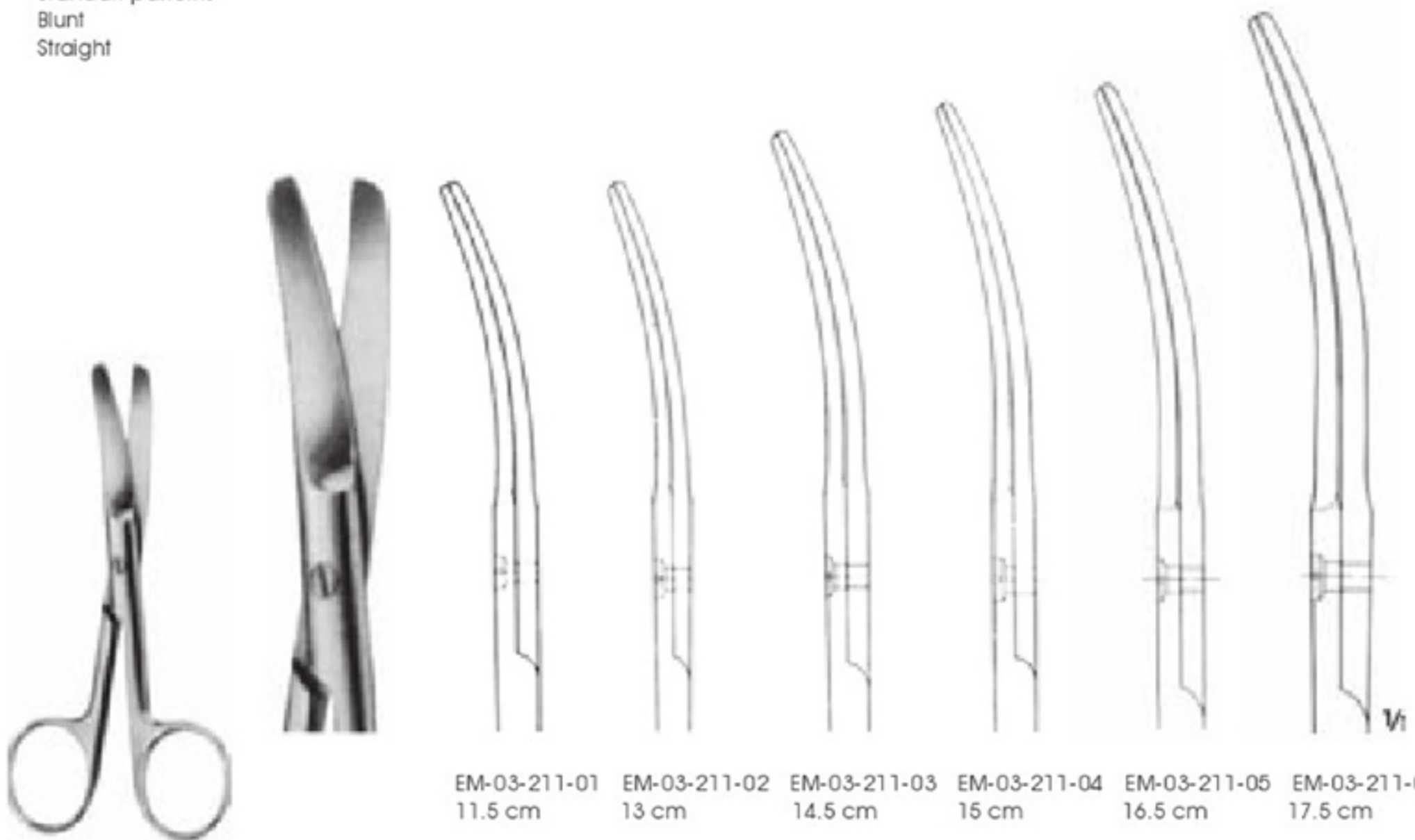

EM-03-211-01 11.5 cm
EM-03-211-02 13 cm
EM-03-211-03 14.5 cm
EM-03-211-04 15 cm
EM-03-211-05 16.5 cm
EM-03-211-06 17.5 cm

COOPER
EM-03-211-01 - 211-06
Standart patterns
Blunt
Curved

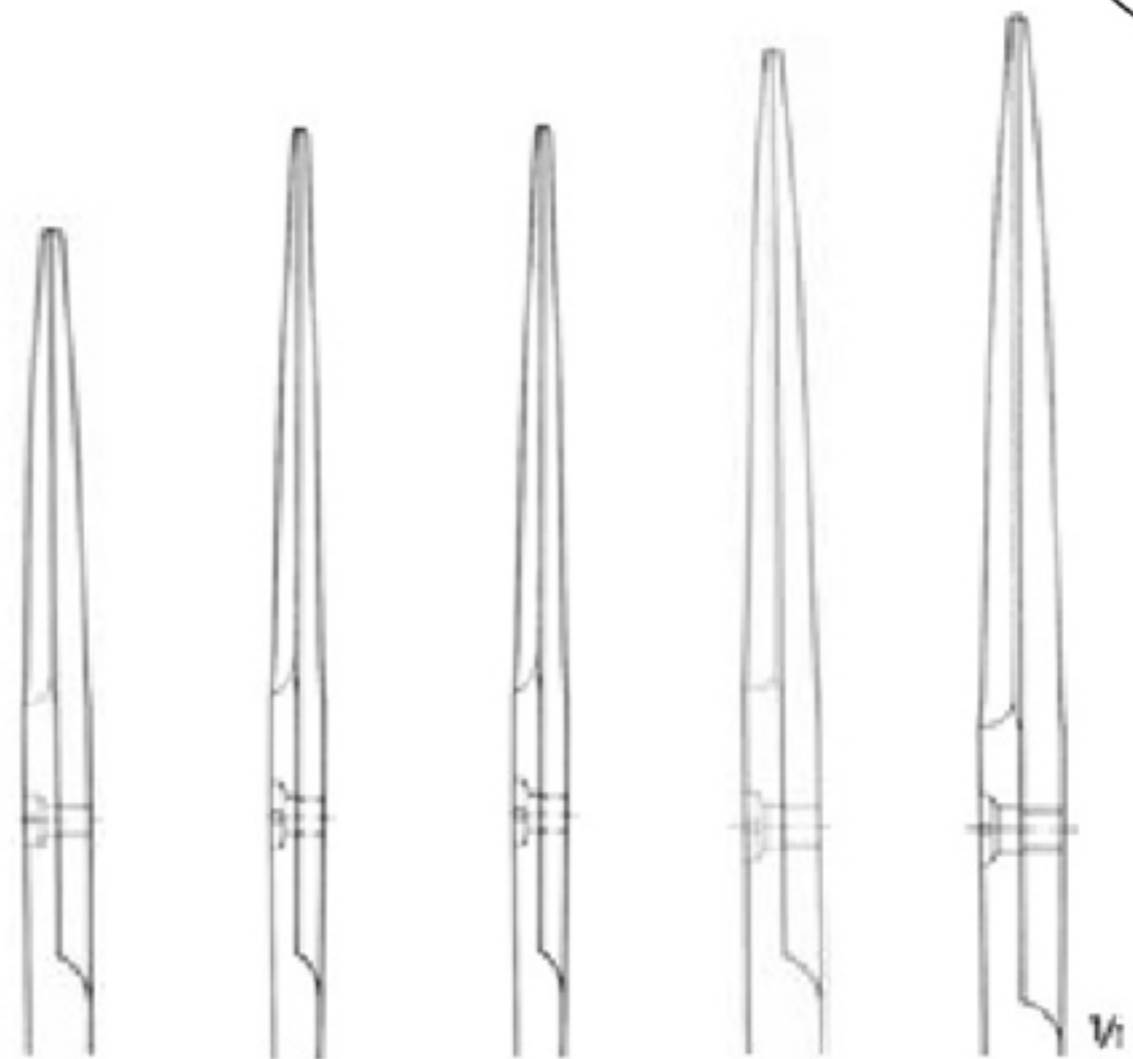

EM-03-212-01 11.5 cm
EM-03-212-02 13 cm
EM-03-212-03 14.5 cm
EM-03-212-04 15 cm
EM-03-212-05 16.5 cm

EM-03-212-01 - 212-05
Standart patterns
Sharp
Straight

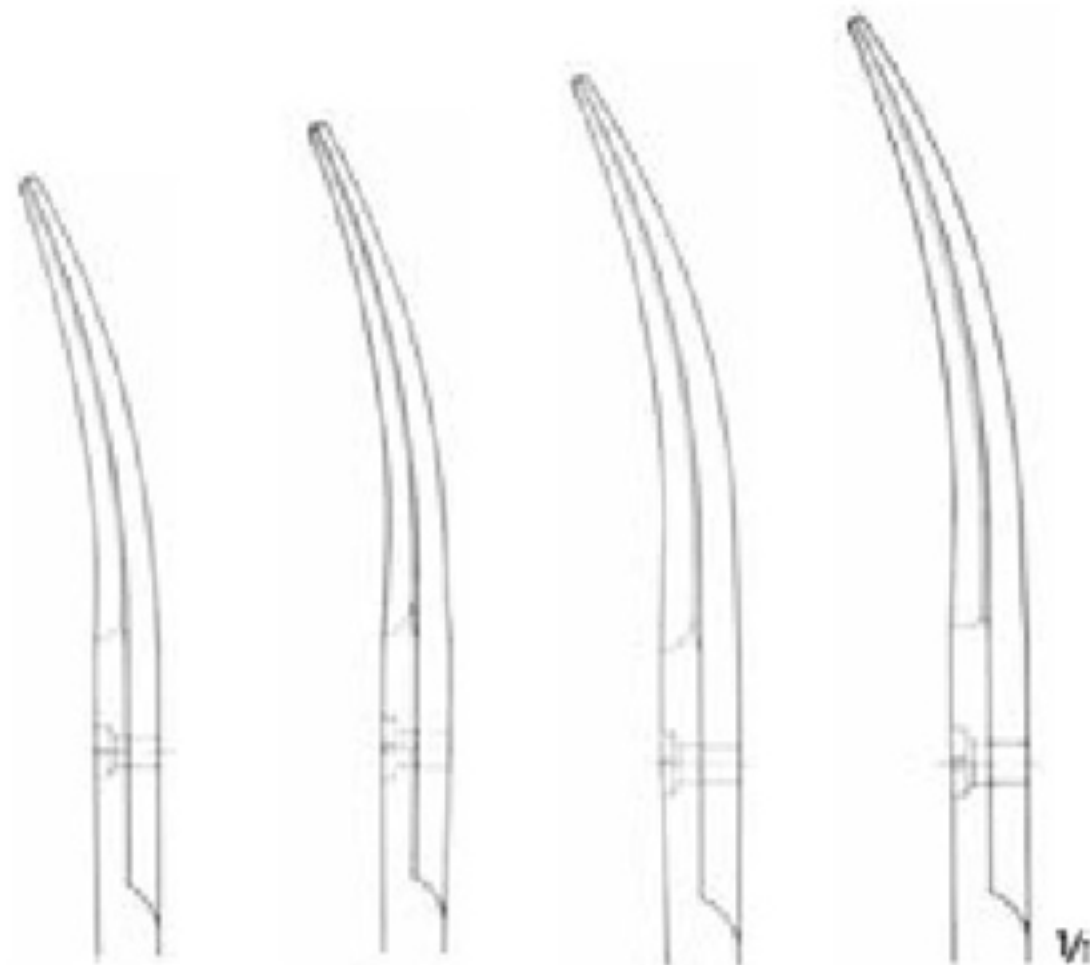
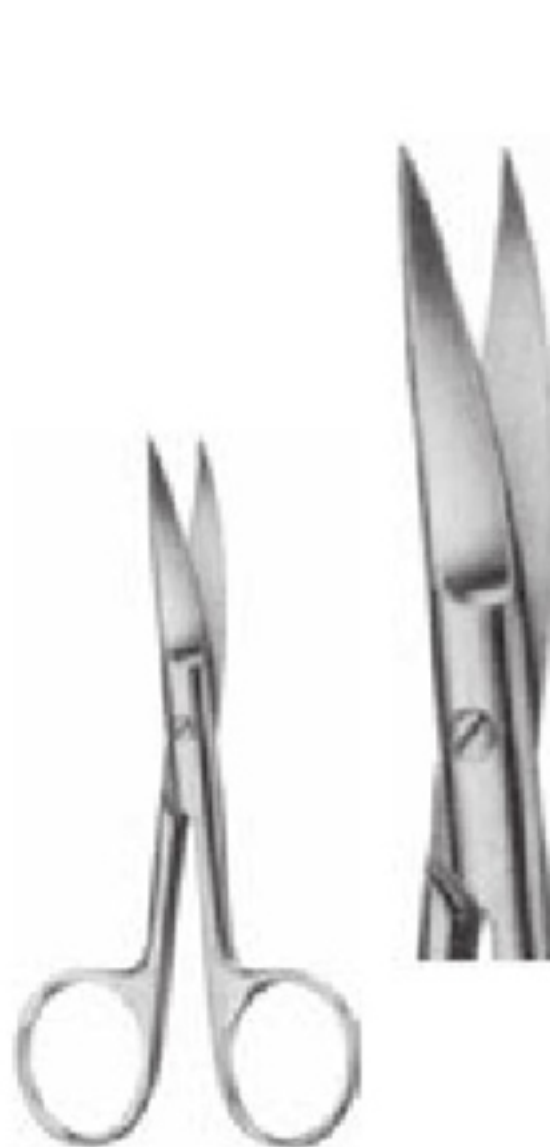

EM-03-213-01 11.5 cm
EM-03-213-02 13 cm
EM-03-213-03 14.5 cm
EM-03-213-04 15 cm

EM-03-213-01 - 213-04
Standart patterns
Sharp
Curved

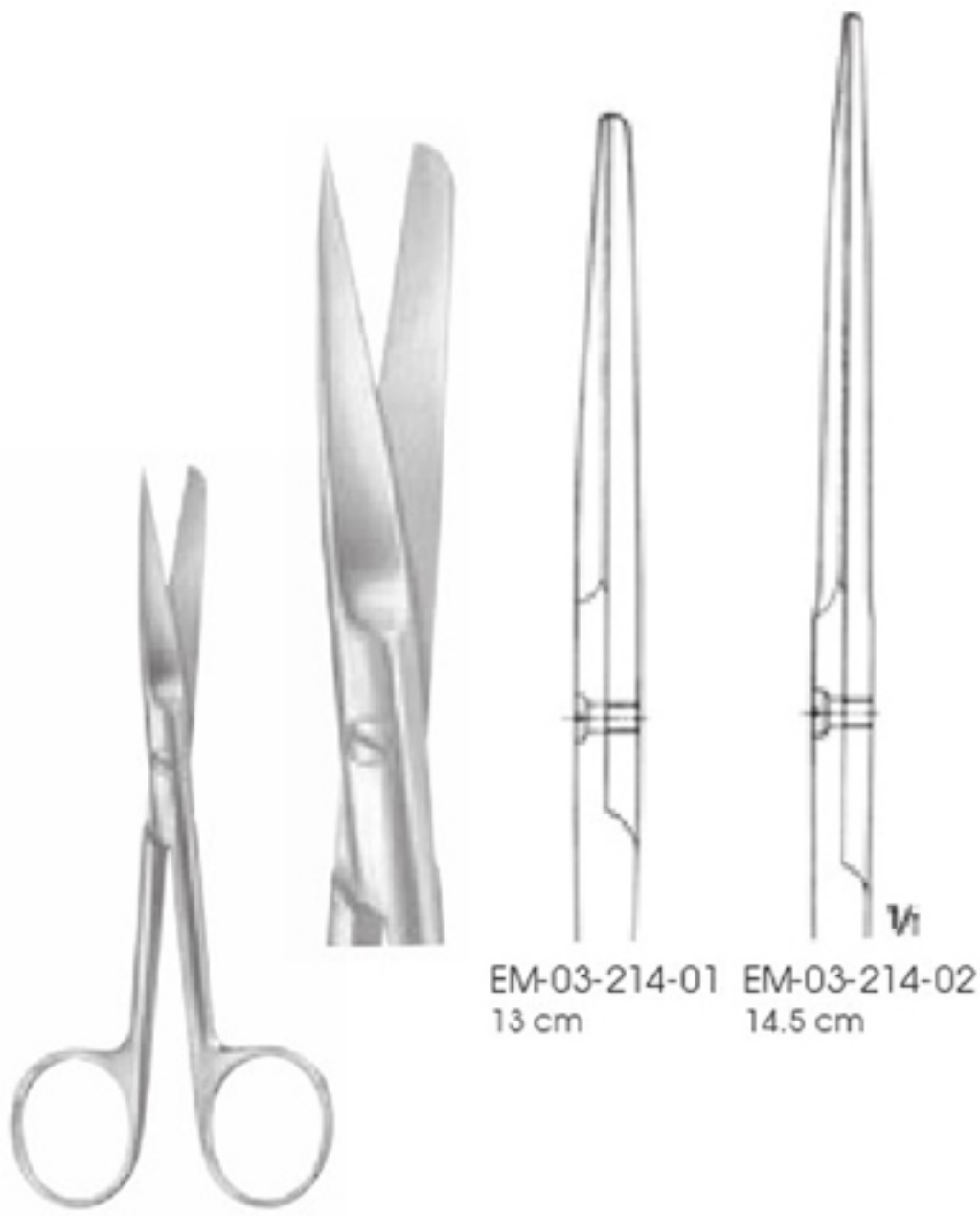

EM-03-214-01 13 cm
EM-03-214-02 14.5 cm

EM-03-214-01 - 214-02
Slender patterns
Sharp-Blunt
Straight

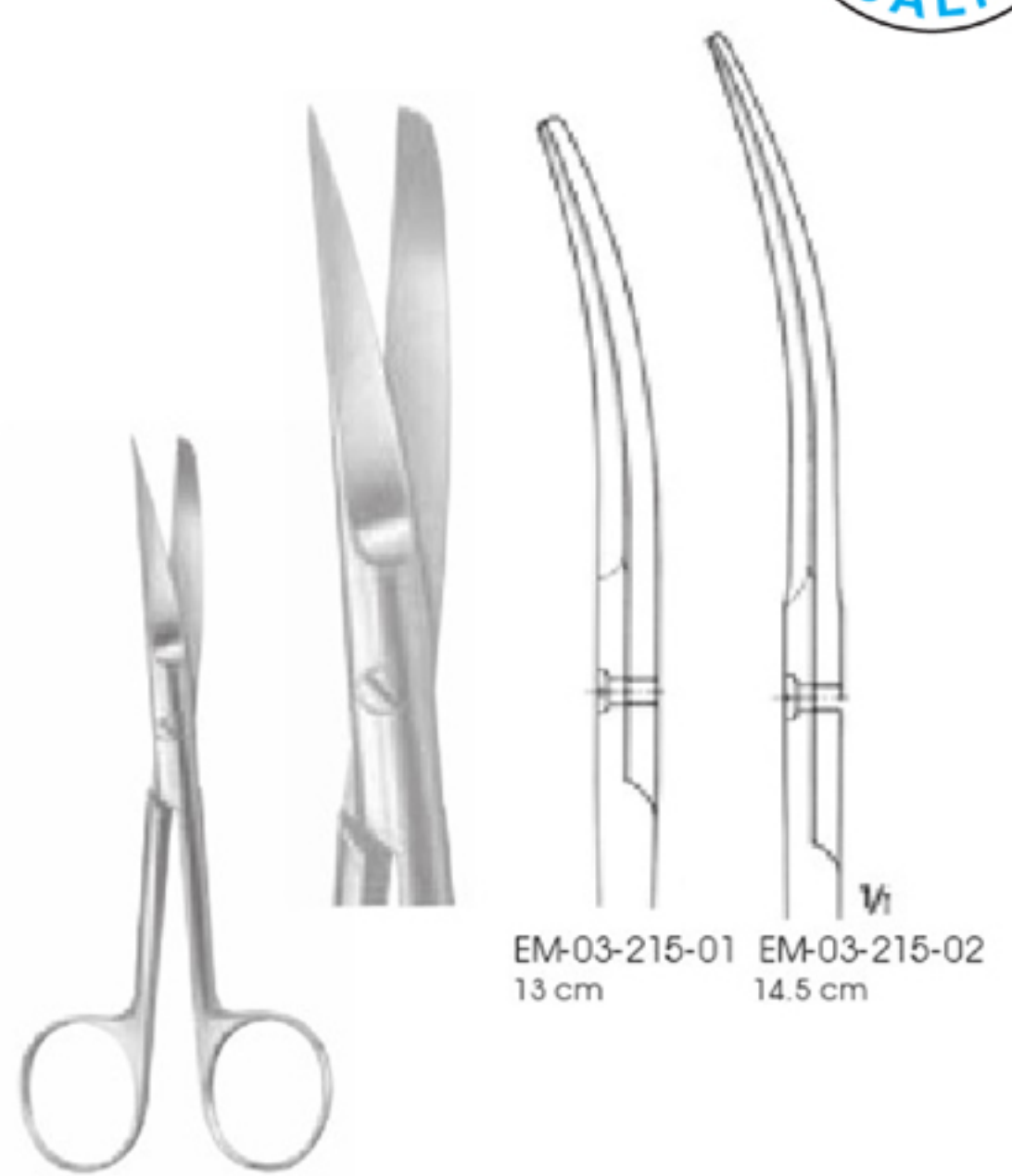

EM-03-215-01 13 cm
EM-03-215-02 14.5 cm

EM-03-215-01 - 215-02
Slender patterns
Sharp-Blunt
Curved

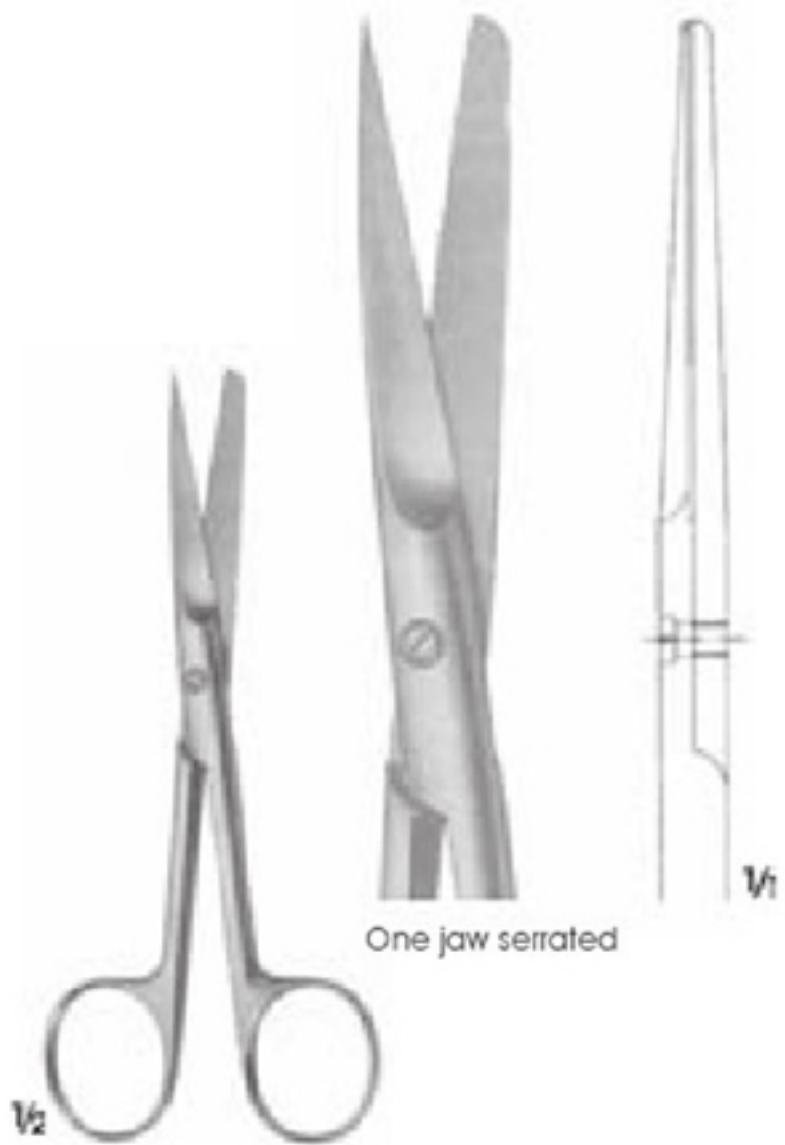

One jaw serrated

EM-03-216
Scissors for wound edges
Sharp-Blunt
Straight
13 cm



One jaw serrated

EM-03-217
Scissors for wound edges
Sharp-Blunt
Curved
13 cm

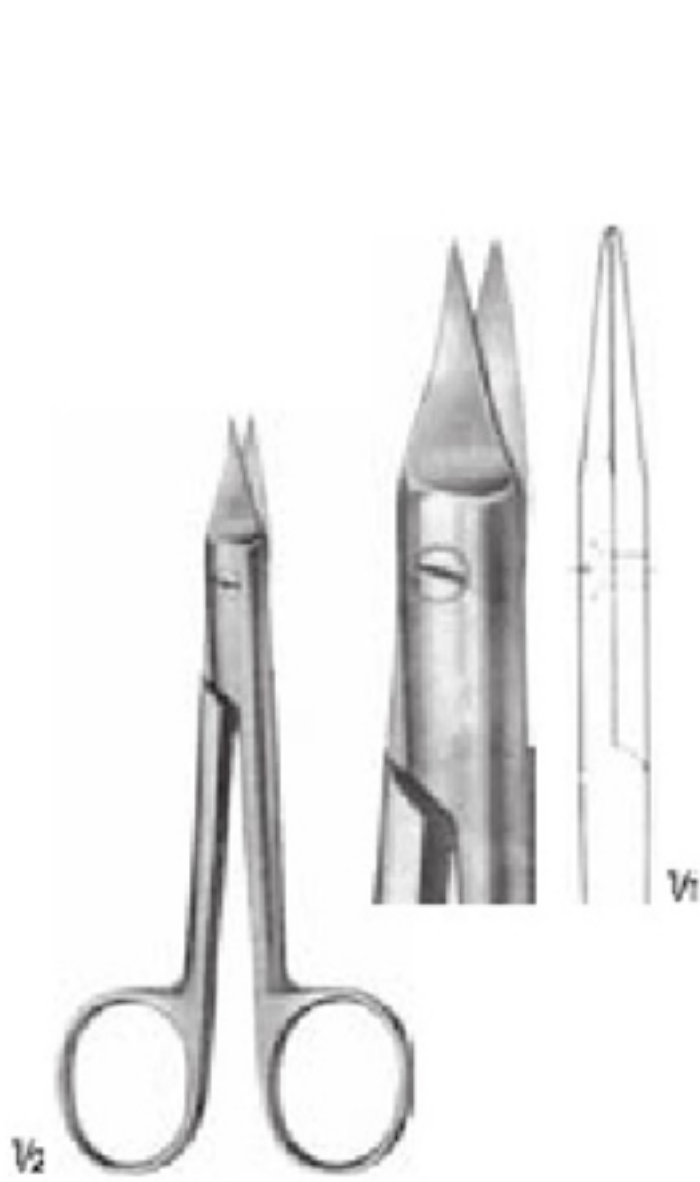

SYSTRUNK
EM-03-218
Sert doku makası/Nail splitting scissors
13 cm



EM-03-219-01 - 219-03
Incision scissors
Straight

EM-03-219-01 13 cm
EM-03-219-02 14.5 cm
EM-03-219-03 16.5 cm

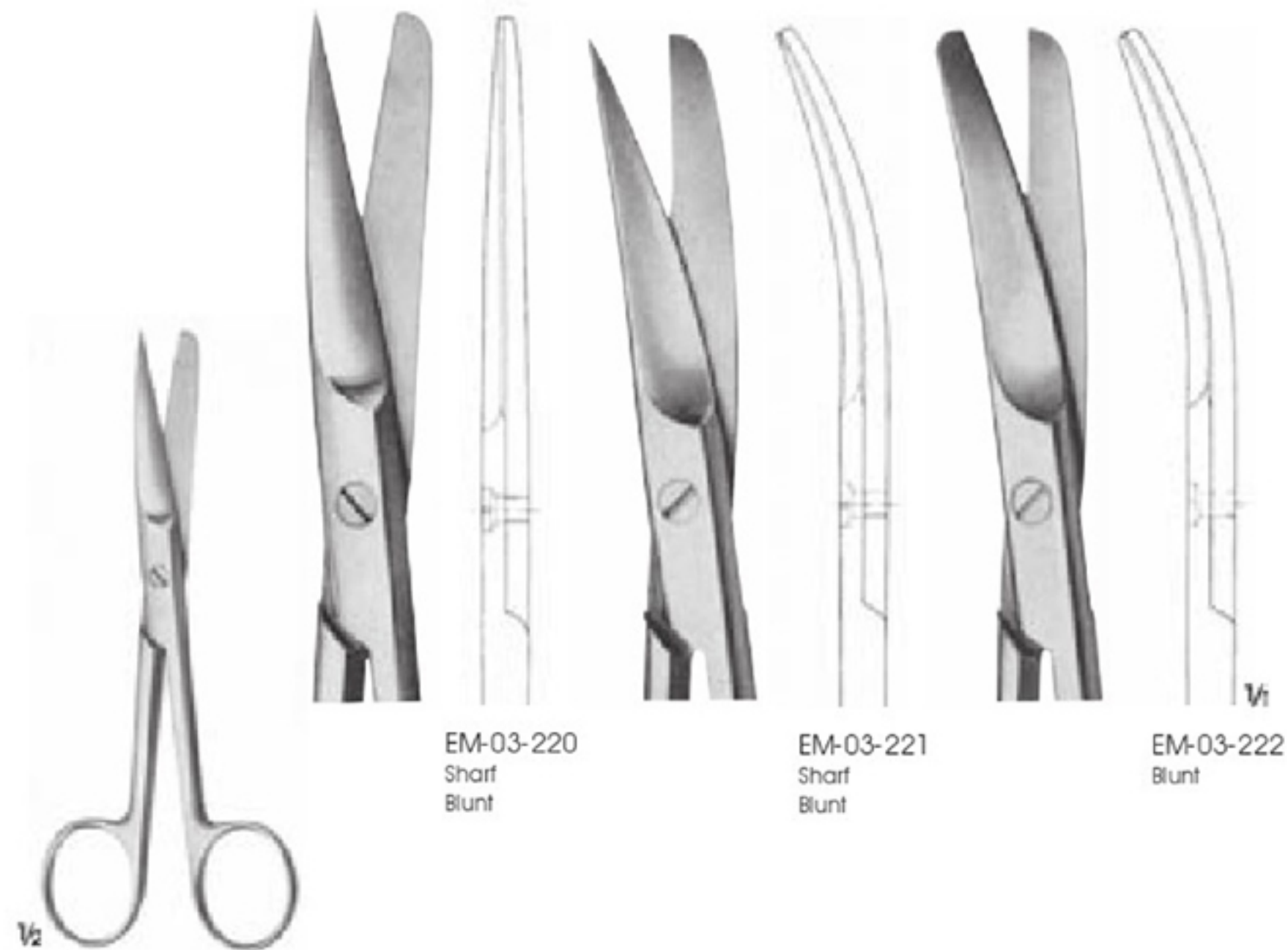

DEAVER
EM-03-220 - 222
Surgical scissors
14.5 cm

EM-03-220
Sharf
Blunt

EM-03-221
Sharf
Blunt

EM-03-222
Blunt



GRAEFE
 EM-03-223 Blunt
 Dissecting scissors
 10 cm



EM-03-224 Straight
 EM-03-225 Curved
 Dissecting scissors
 11.5 cm



COTTLE
 EM-03-226
 Bulldog scissors
 11.5 cm



LITTLER
 EM-03-227
 Dissecting scissors, tips with eye suture
 11.5 cm



KILNER
 EM-03-228
 Delicate dissecting scissors
 11.5 cm



EM-03-229-01
 Curved
 12.5 cm

EM-03-229-02
 Curved
 15 cm

KILNER
 EM-03-229-01 - 229-02
 Special flat points for dissecting and
 undermining the skin



EM-03-230
 Sharp

EM-03-231
 Blunt

COTTLE-MASING
 EM-03-230 - 231
 Scissors for plastic surgery
 10.5 cm



EM-03-232
 Curved
 11.5 cm

EM-03-233
 Curved
 13.5 cm

FOMON
 EM-03-232 - 233
 Lower lateral scissors

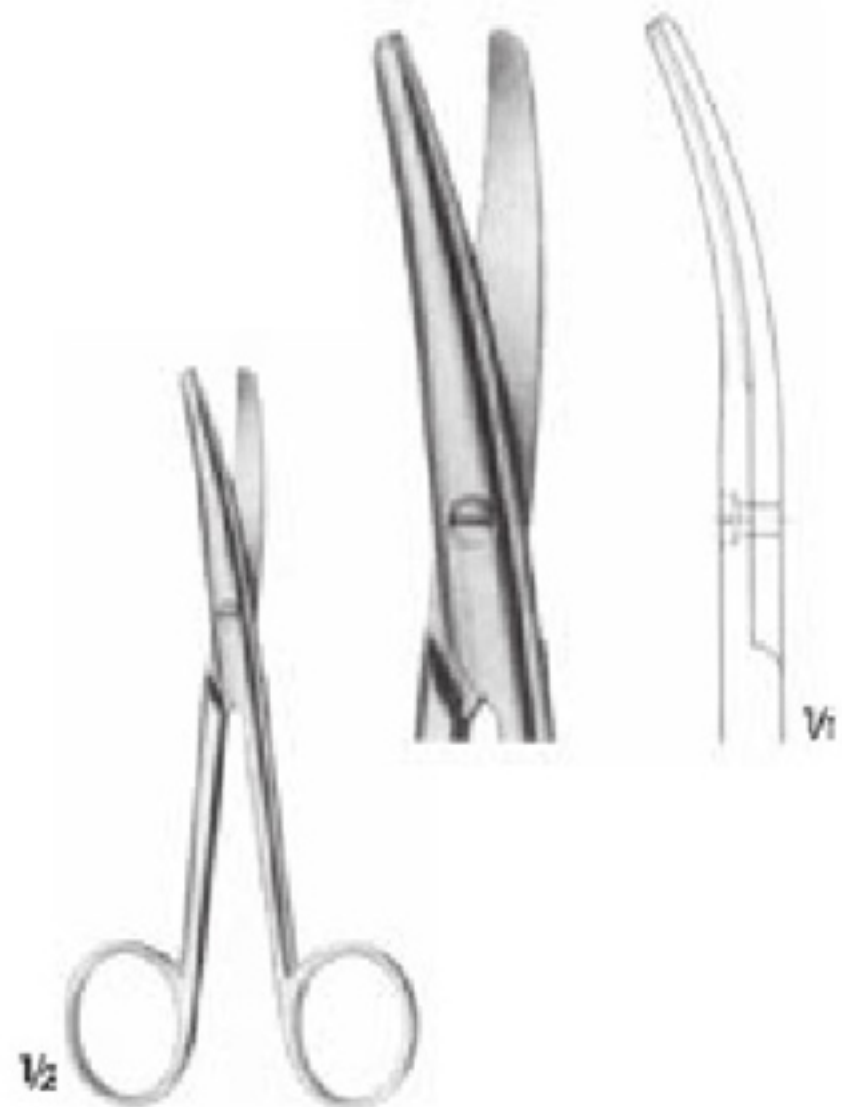

LANDOLT
 EM-03-234
 Enucleation scissors
 12 cm



AreCut



EM-03-235-01
 Straight

EM-03-235-02
 Curved

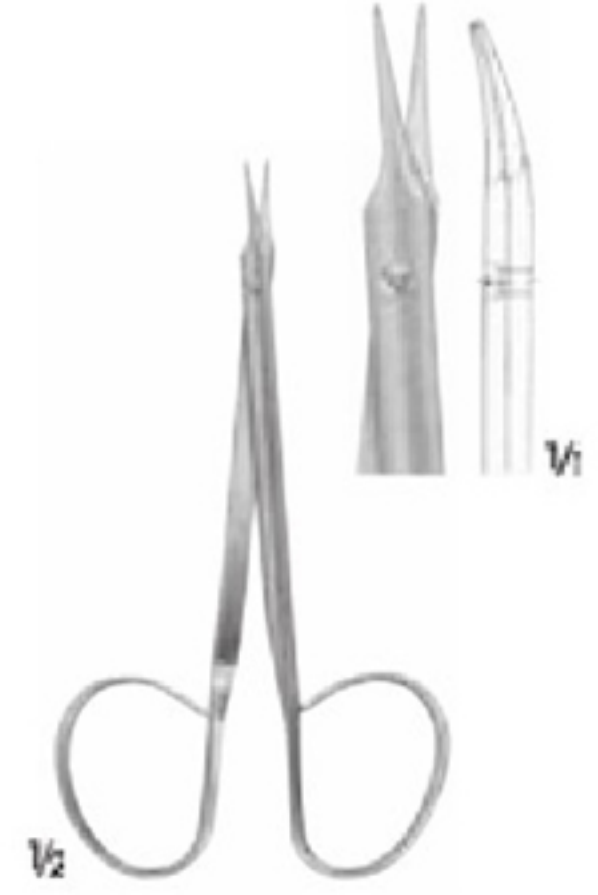

STEVENS
 EM-03-236
 Delicate dissecting scissors
 11 cm

STEVENS
 EM-03-235-01 - 235-02
 Vascular and tendon scissors
 10 cm

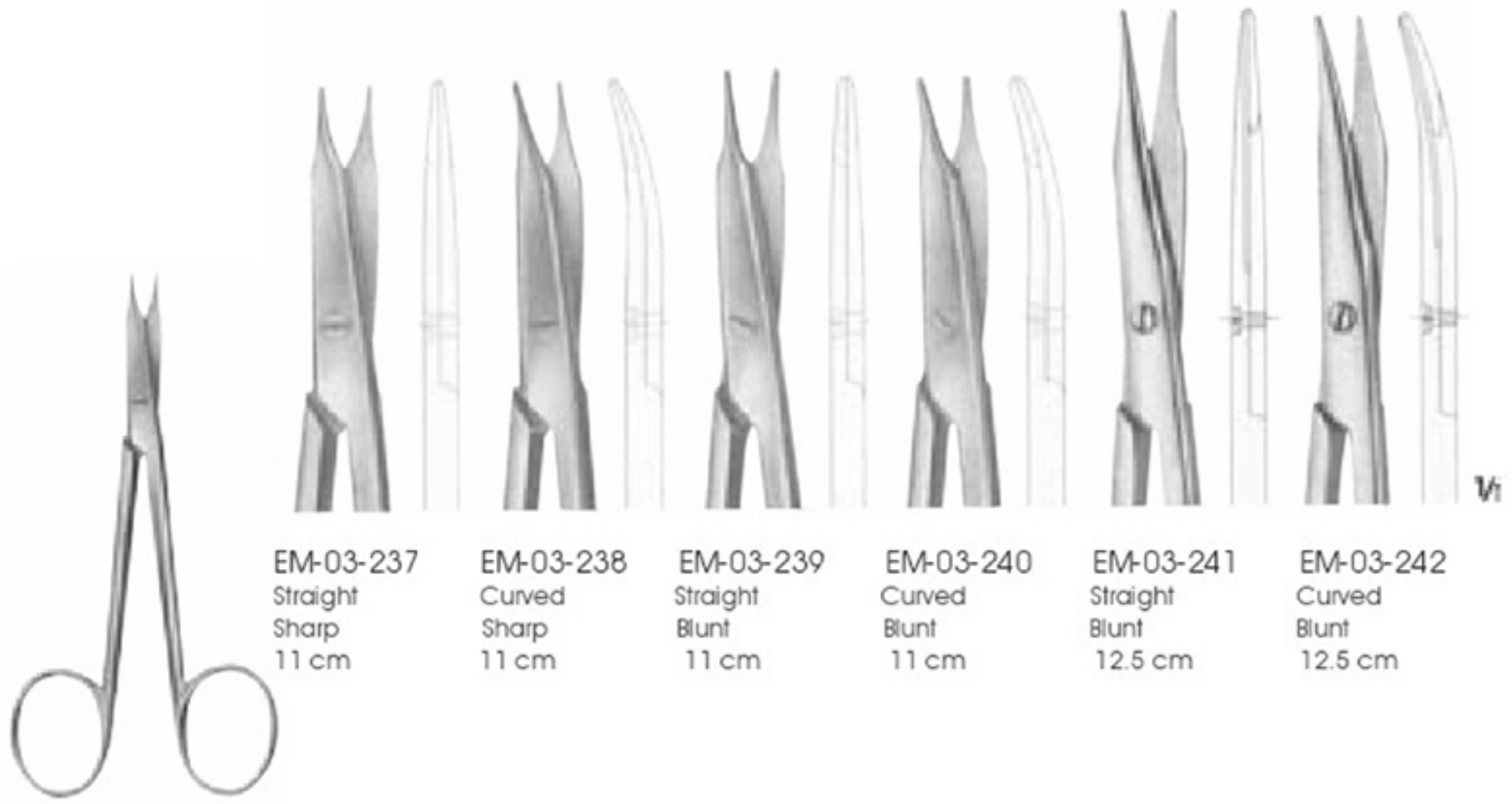

EM-03-237
 Straight
 Sharp
 11 cm

EM-03-238
 Curved
 Sharp
 11 cm

EM-03-239
 Straight
 Blunt
 11 cm

EM-03-240
 Curved
 Blunt
 11 cm

EM-03-241
 Straight
 Blunt
 12.5 cm

EM-03-242
 Curved
 Blunt
 12.5 cm

STEVENS
 EM-03-237 - 242
 Vascular and tendon scissors

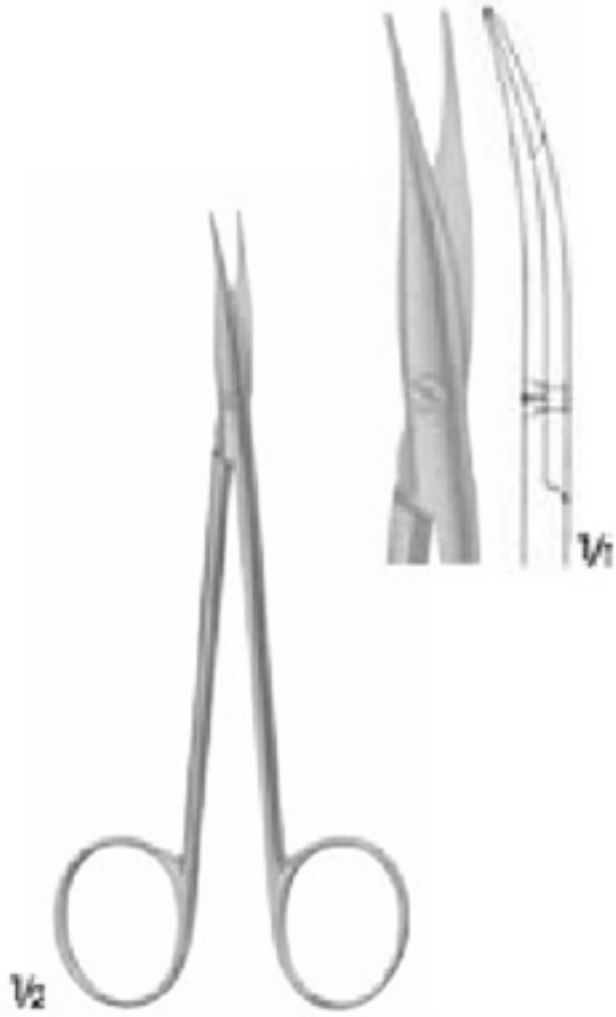

JAMESON-WERBER
 EM-03-243
 Dissecting scissors
 13 cm



JAMESON
 EM-03-244
 Dissecting scissors
 15 cm

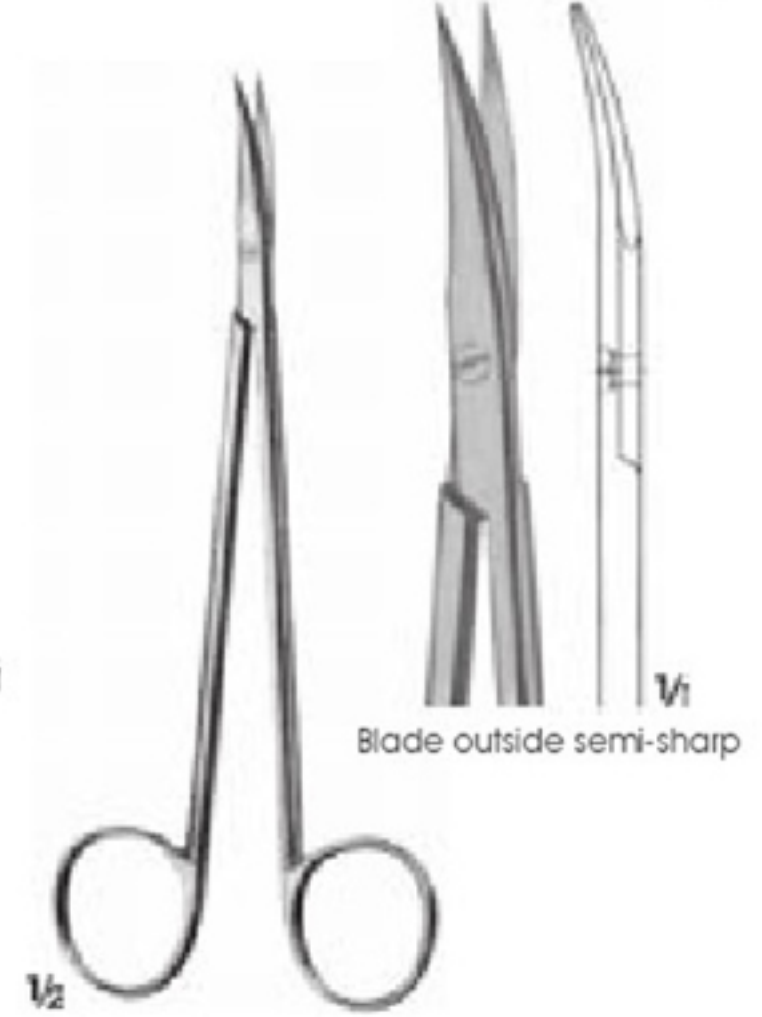

EM-03-245
 Nerve dissection scissors
 15 cm

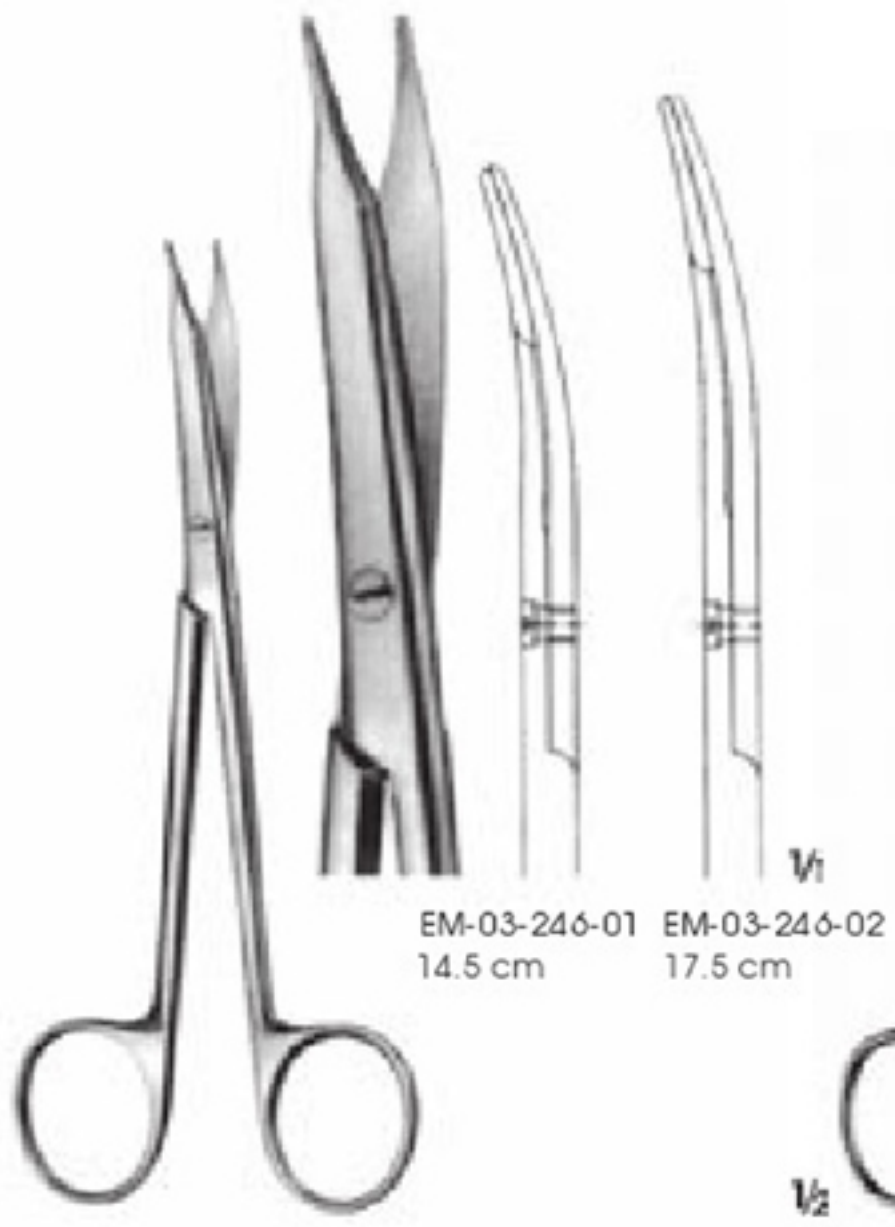

EM-03-246-01 14.5 cm
 EM-03-246-02 17.5 cm

EM-03-246-01 - 246-02
 Dissecting scissors

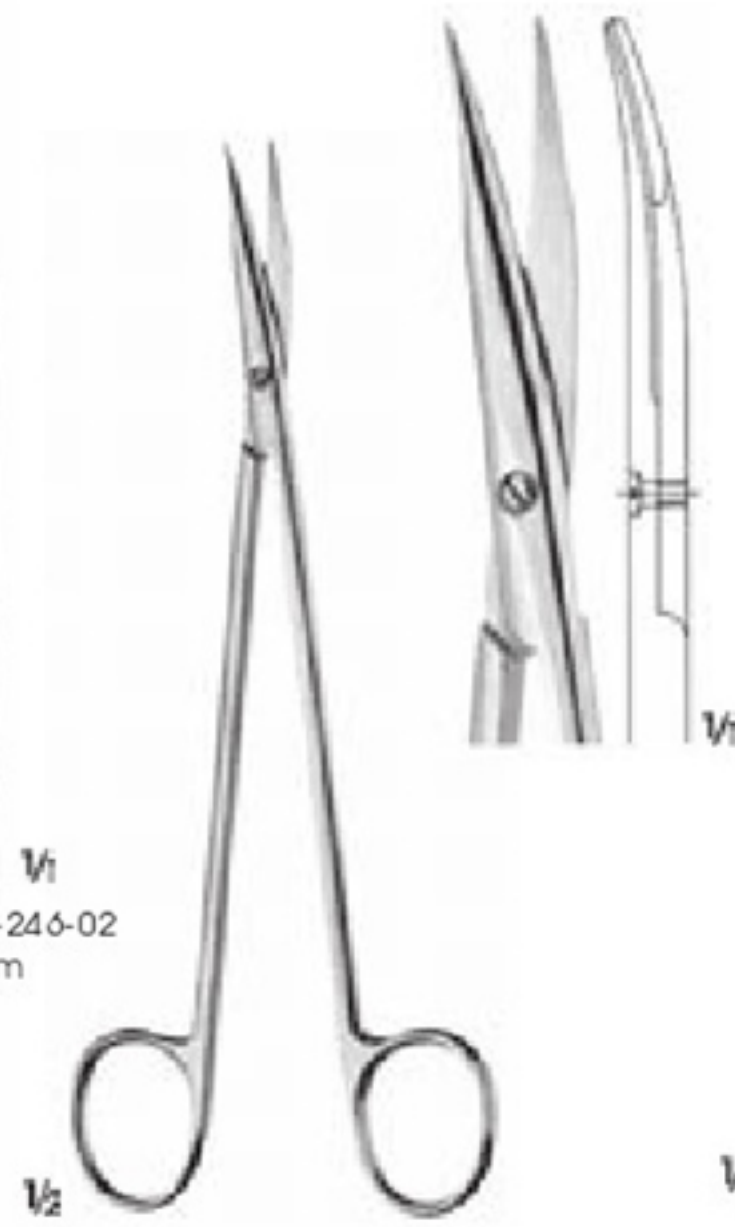

EM-03-247
 Dissecting scissors
 18 cm

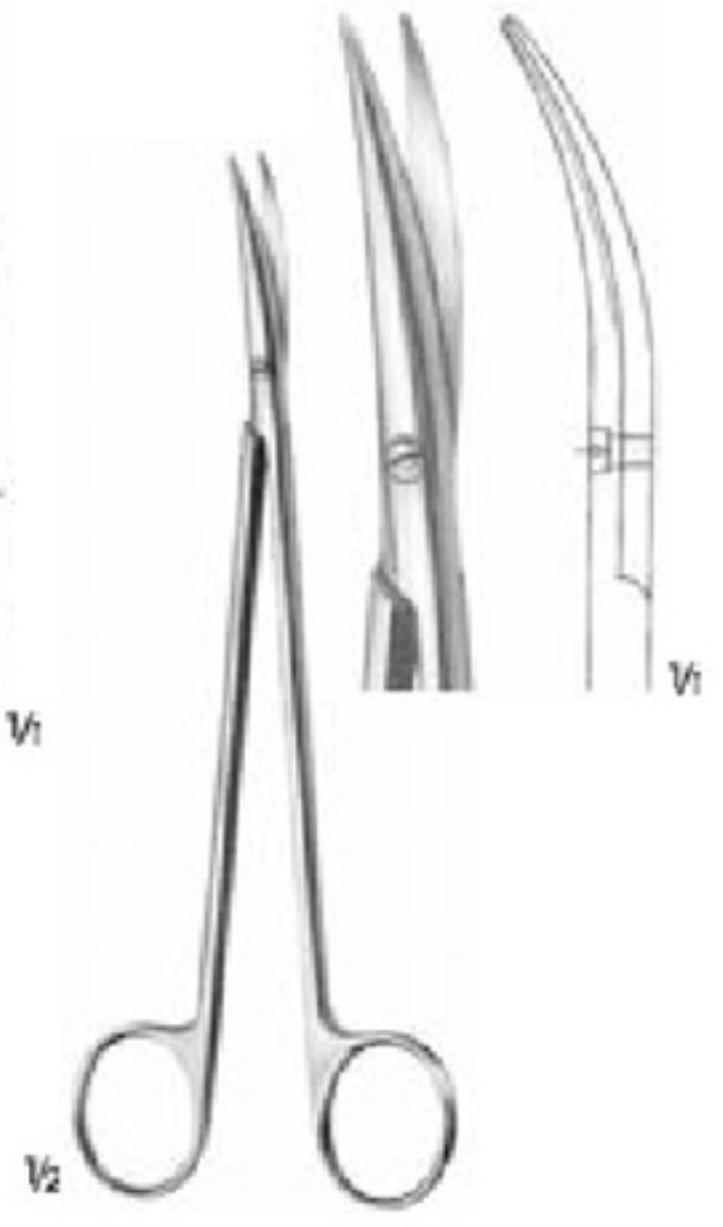

EM-03-248
 Arteriotomy scissors
 17.5 cm



EM-03-249
 Düz/Straight
 Künt/Blunt

EM-03-250
 Eğri/Curved
 Künt/Blunt



EM-03-251
 Straight

EM-03-252
 Curved

EM-03-249 - 250
 Scissors for plastic surgery
 10.5 cm

EM-03-251 - 252
 Dissecting scissors
 14.5 cm



EM-03-253-01
 Straight
 20 cm

EM-03-253-02
 Curved
 16 cm



EM-03-254-01
 Very delicate

EM-03-254-02
 Delicate

EM-03-253-01 - 253-02
 Dissecting scissors

EM-03-254-01 - 254-02
 Dissecting scissors
 17.5 cm

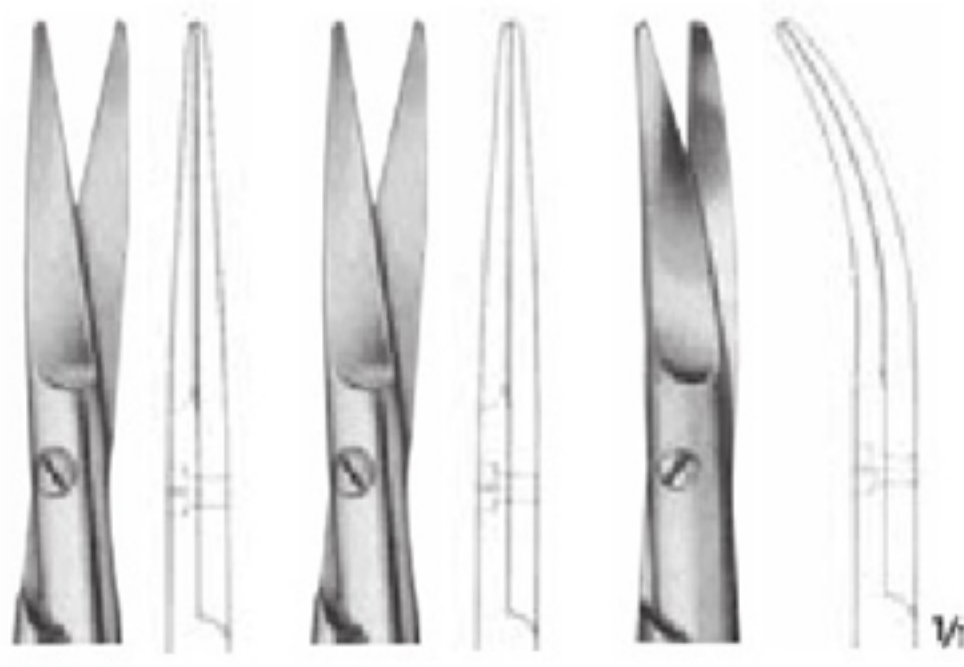

EM-03-255-01
 Very delicate

EM-03-255-02
 Delicate

EM-03-255-03
 Delicate

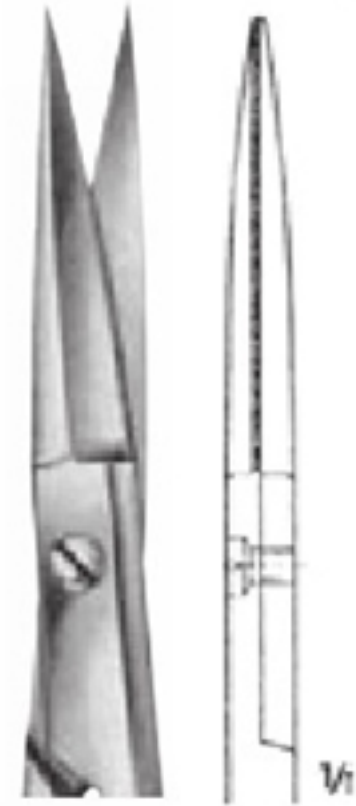
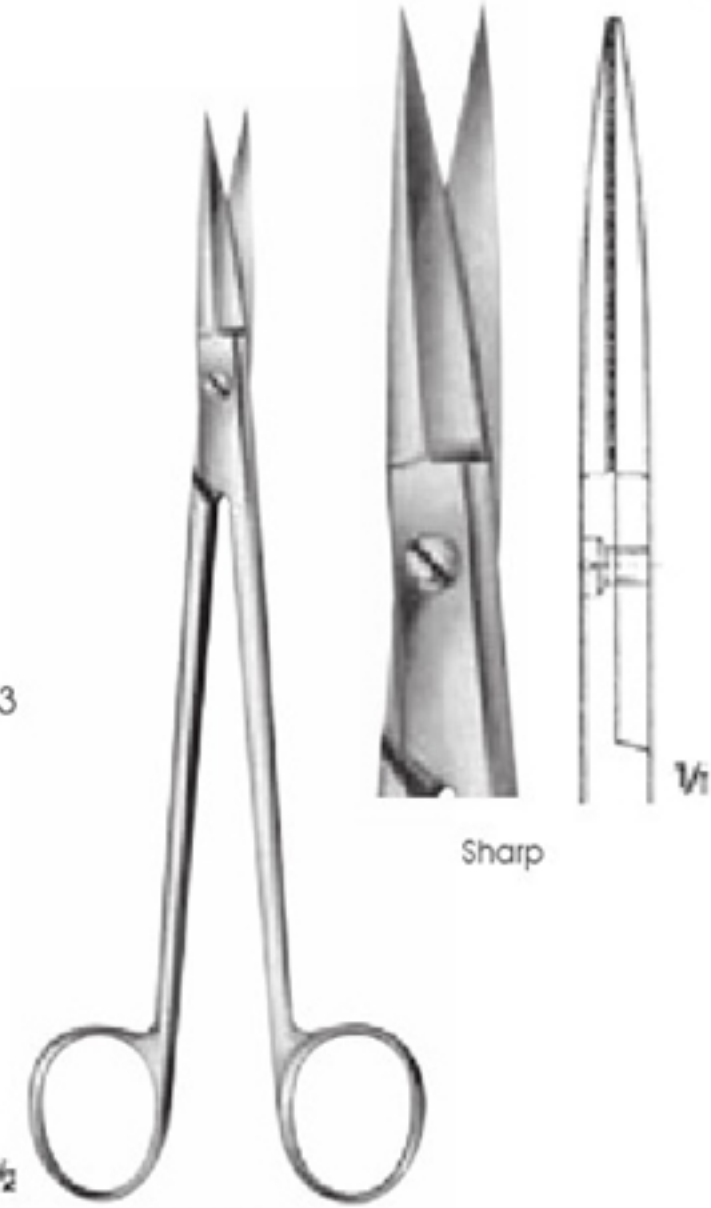

Sharp

EM-03-255-01 - 255-03
 Dissecting scissors
 18 cm

EM-03-256
 Cartilage scissors, blades
 cutting on both sides
 18.5 cm



Blade : Outside semi-sharp
 Inside fine serrated

EM-03-257
 Dissection scissor for plastic surgery
 12.5 cm



EM-03-258
 Straight

EM-03-259
 Curved

EM-03-258 - 259
 Dissection scissors for plastic surgery
 19.5 cm

Blades : Outside semi-sharp
 Inside fine serrated

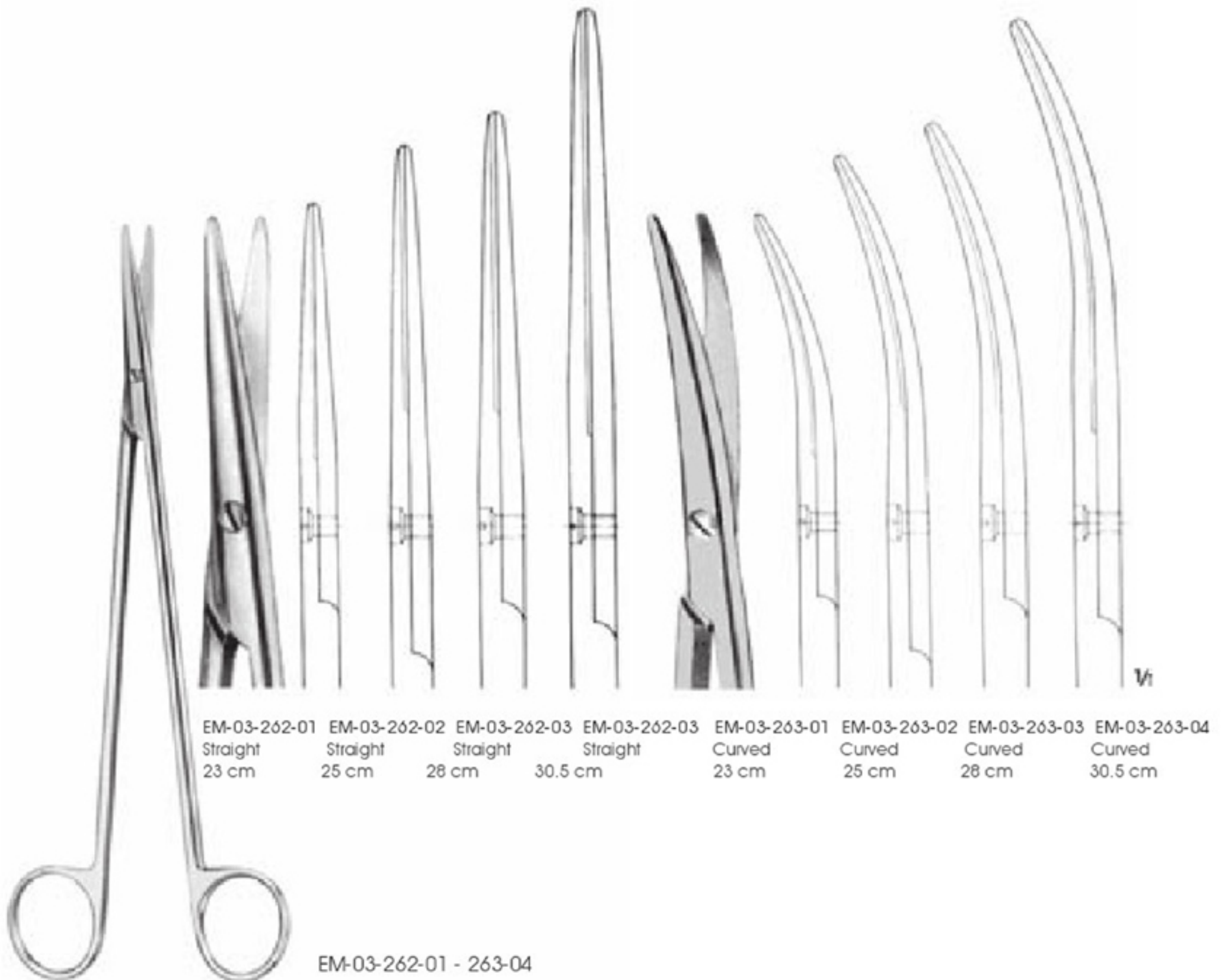
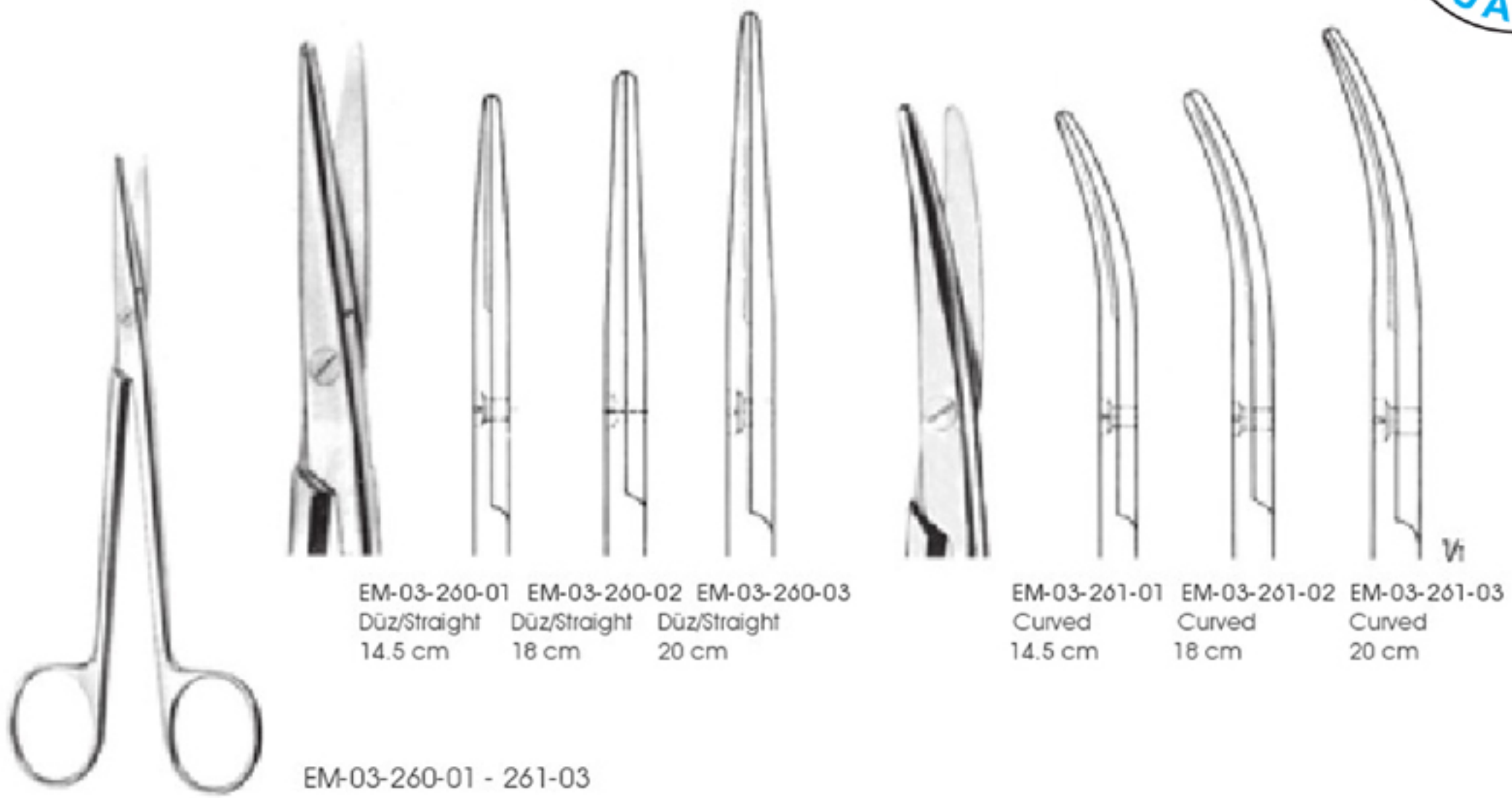



EM-03-264-01 - 265-02
With chamfered blades



EM-03-264-01
14 cm



EM-03-264-02
17 cm



EM-03-265-01
14 cm



EM-03-265-02
17 cm

Vi



MAYO
EM-03-266-01 - 267-02
With chamfered blades



EM-03-266-01
19 cm



EM-03-266-02
21.5 cm



EM-03-267-01
19 cm



EM-03-267-02
21.5 cm

Vi

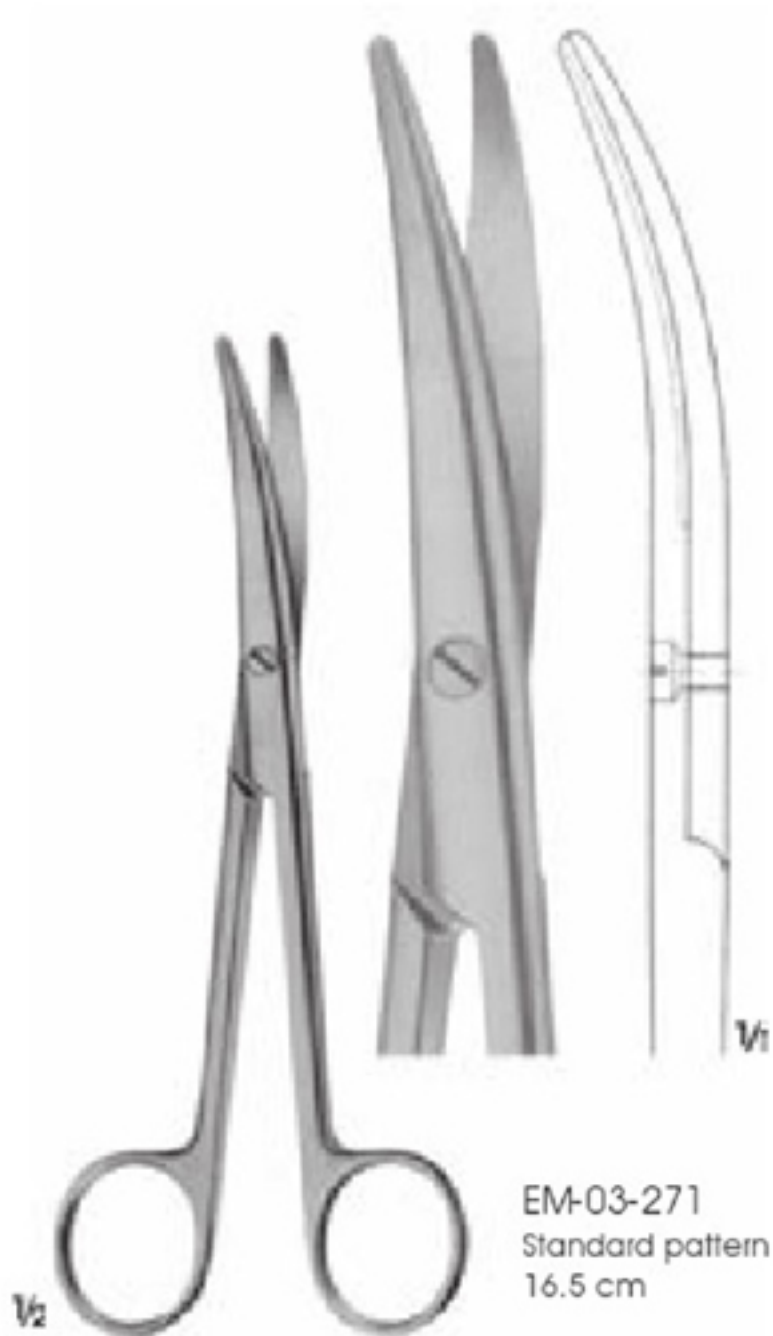
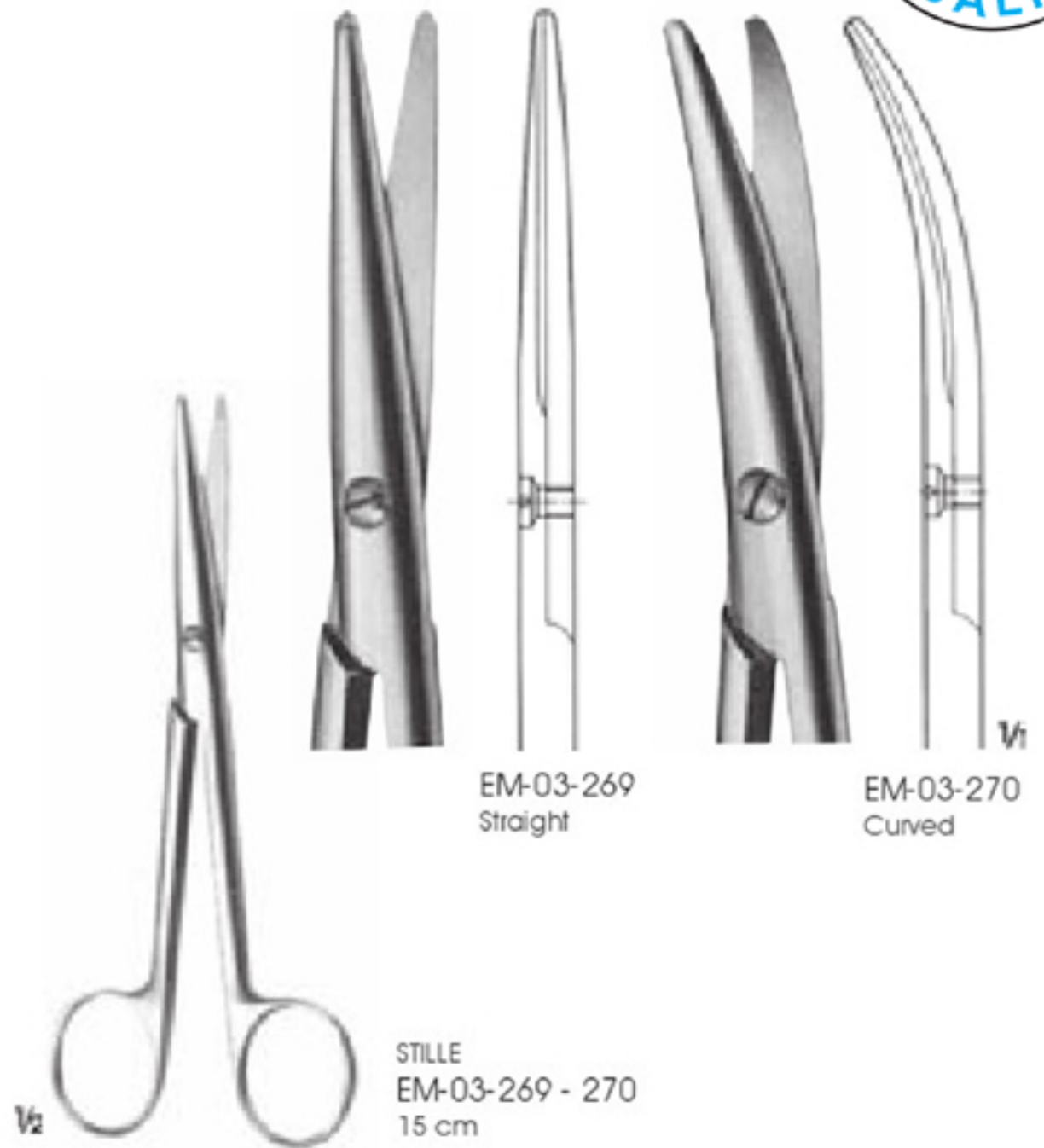
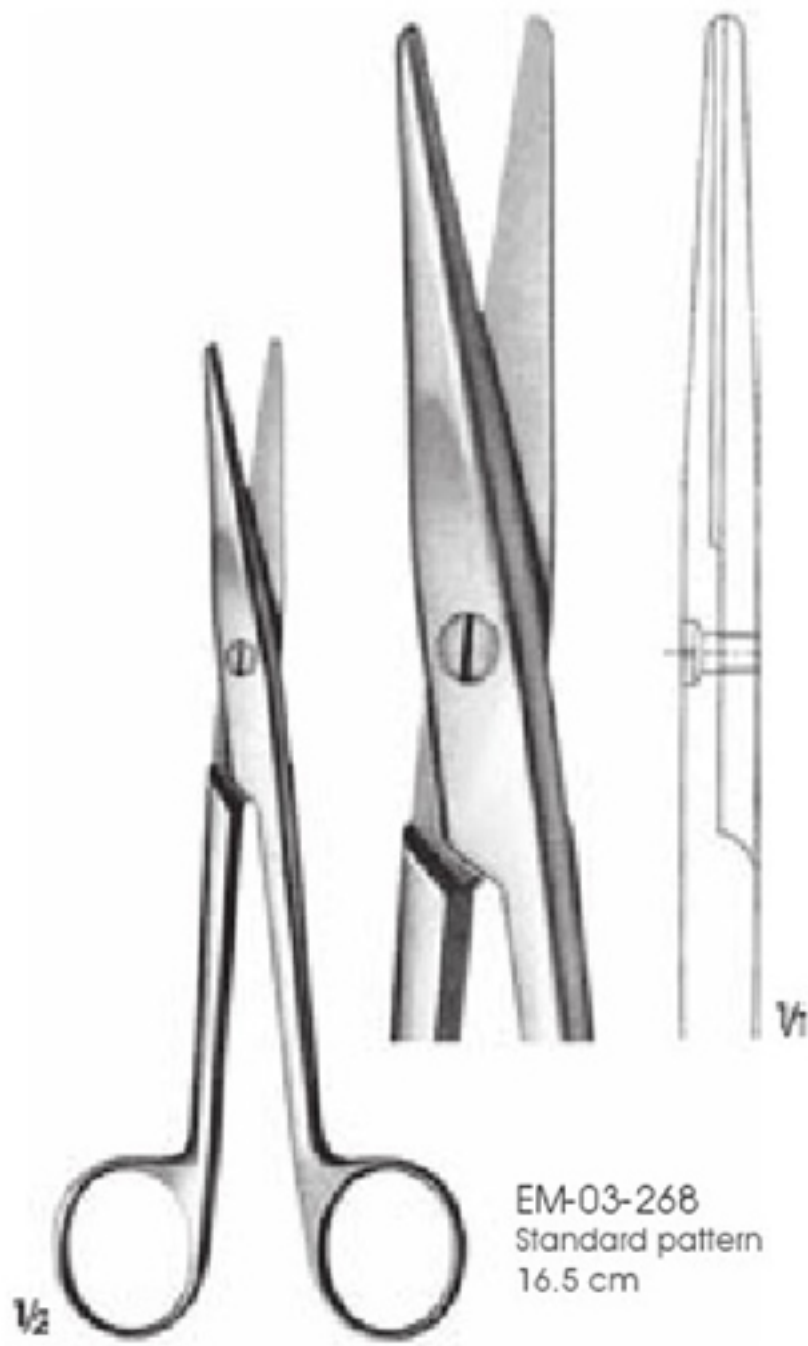

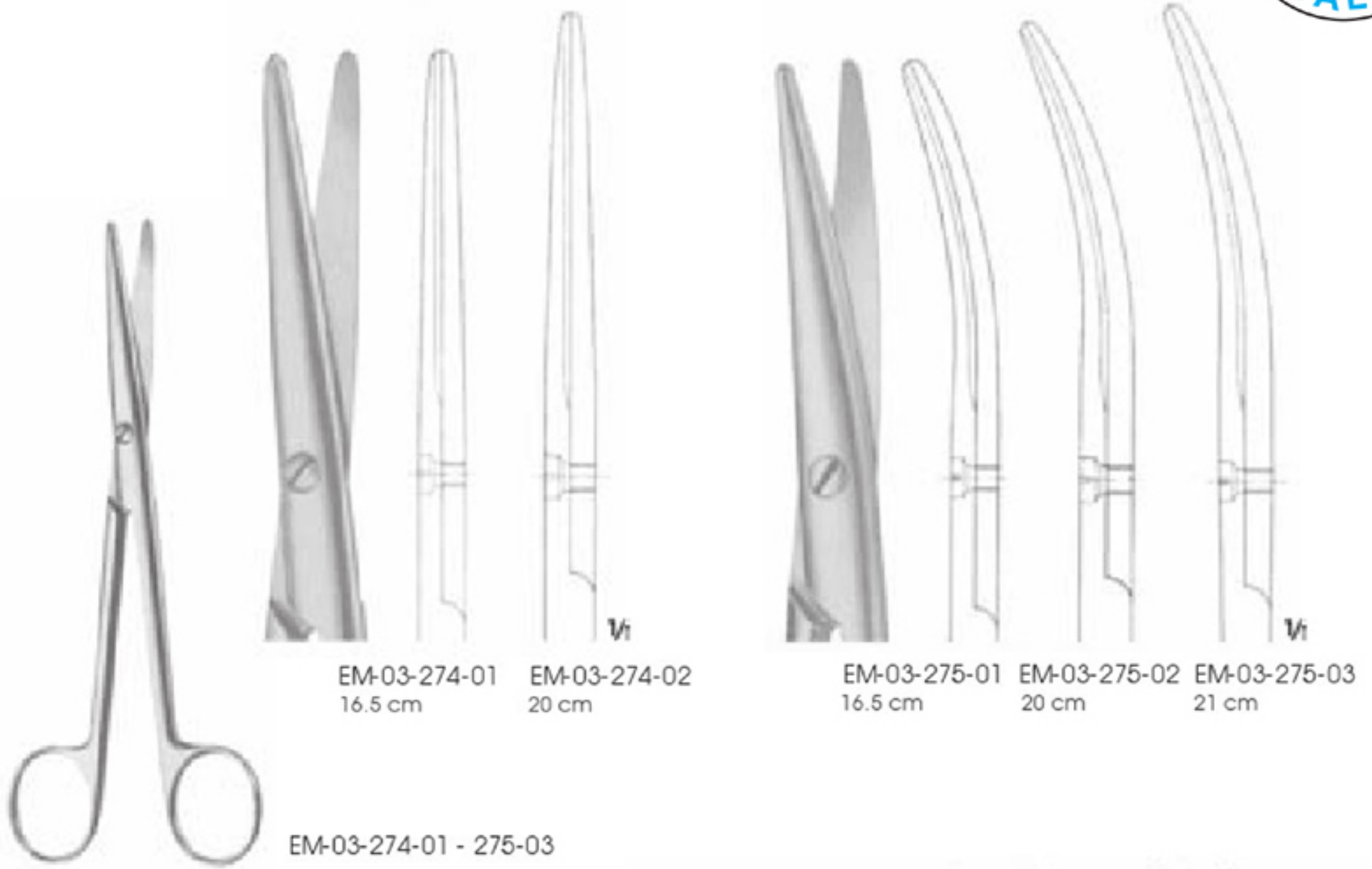

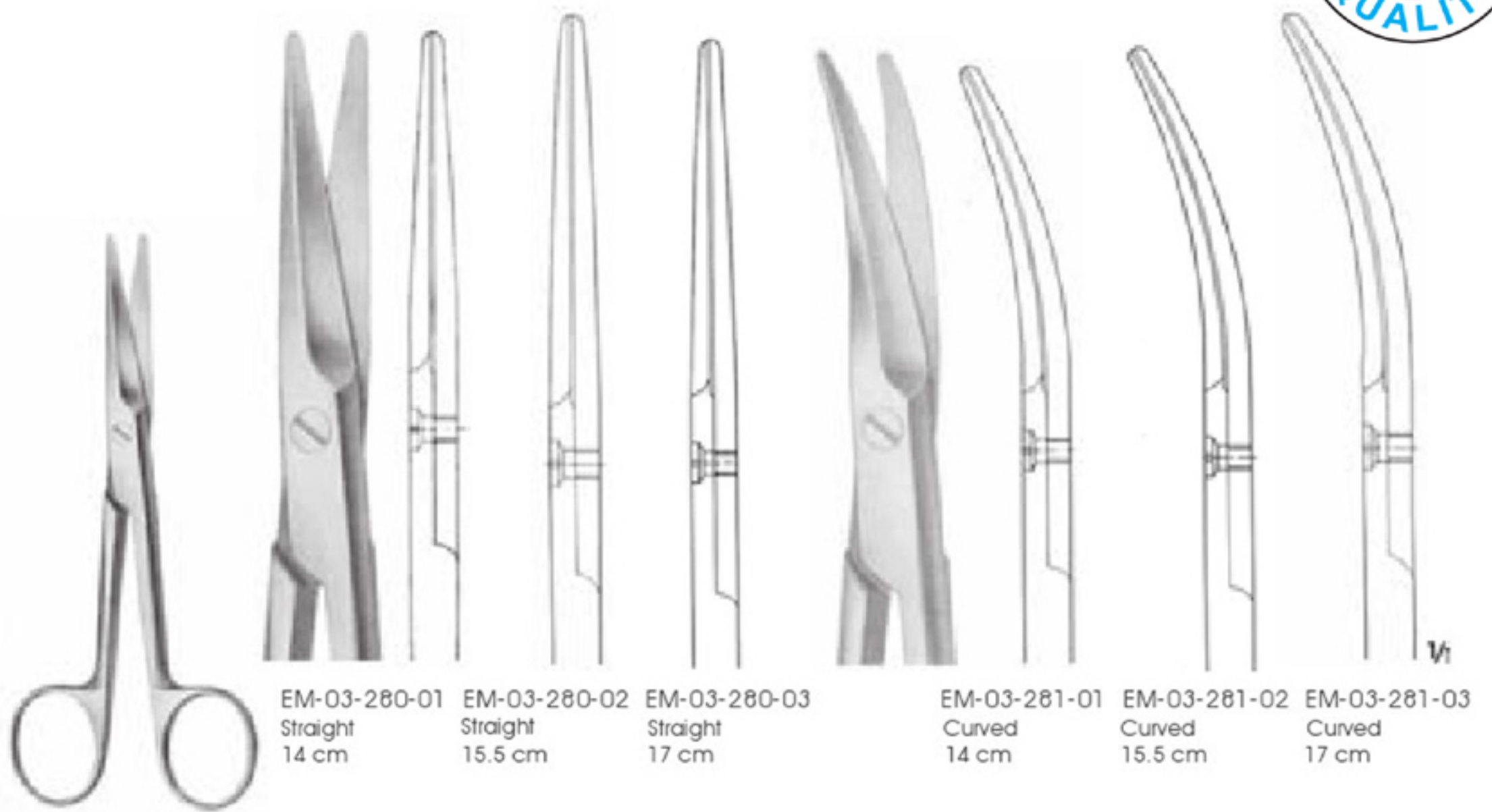

EM-03-280-01 - 281-03

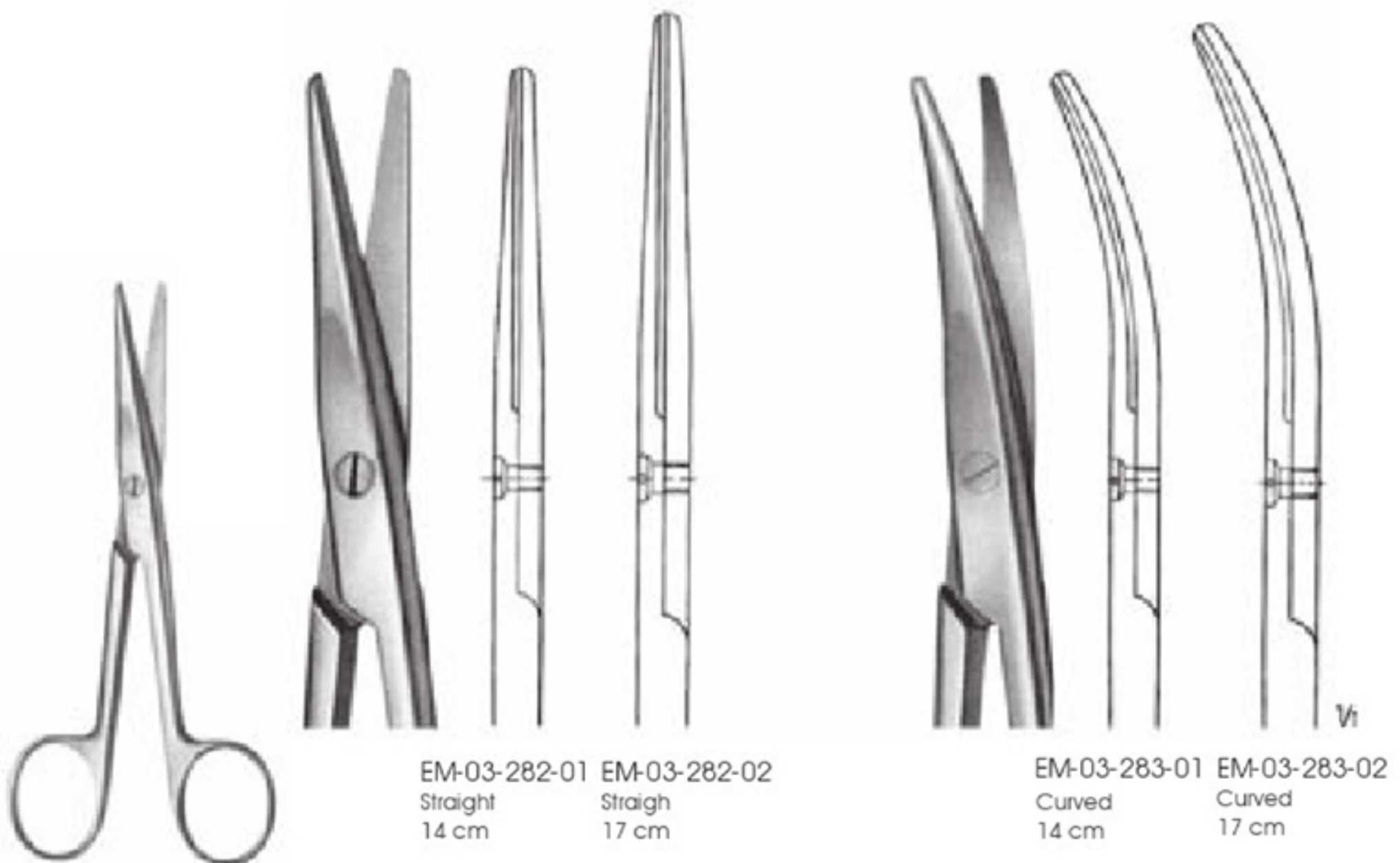

EM-03-282-01 - 283-02

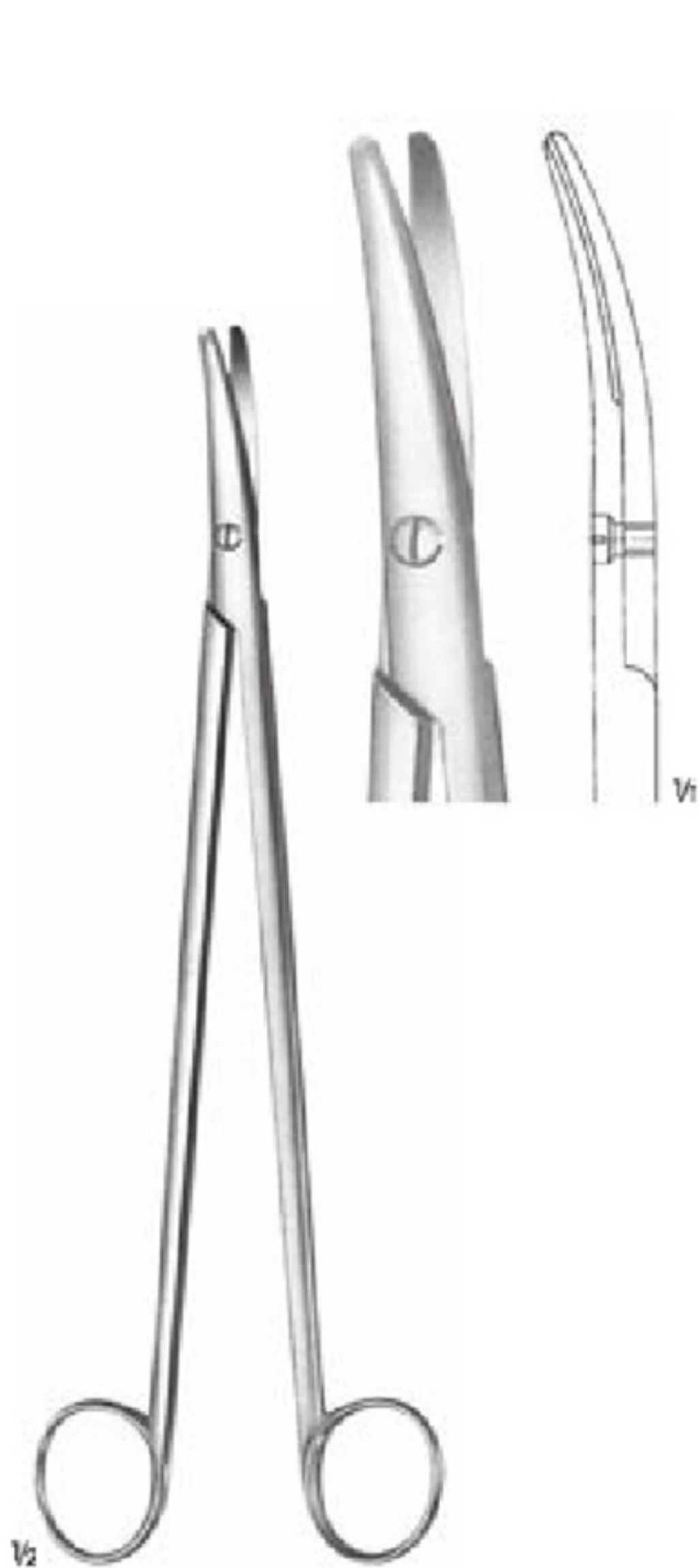

WELLER
EM-03-284
Dissecting scissors, heavy pattern
28 cm

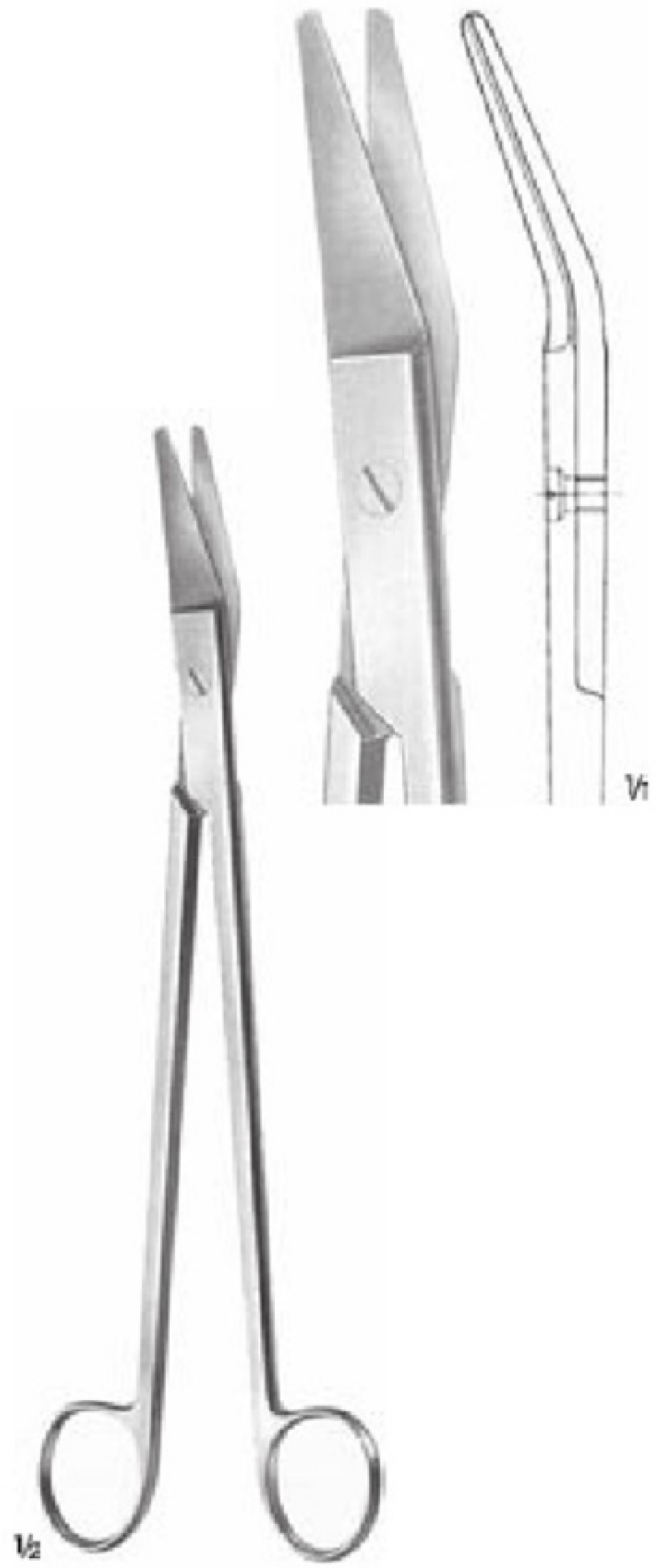

RESANO
EM-03-285
Cartilage scissors
25 cm

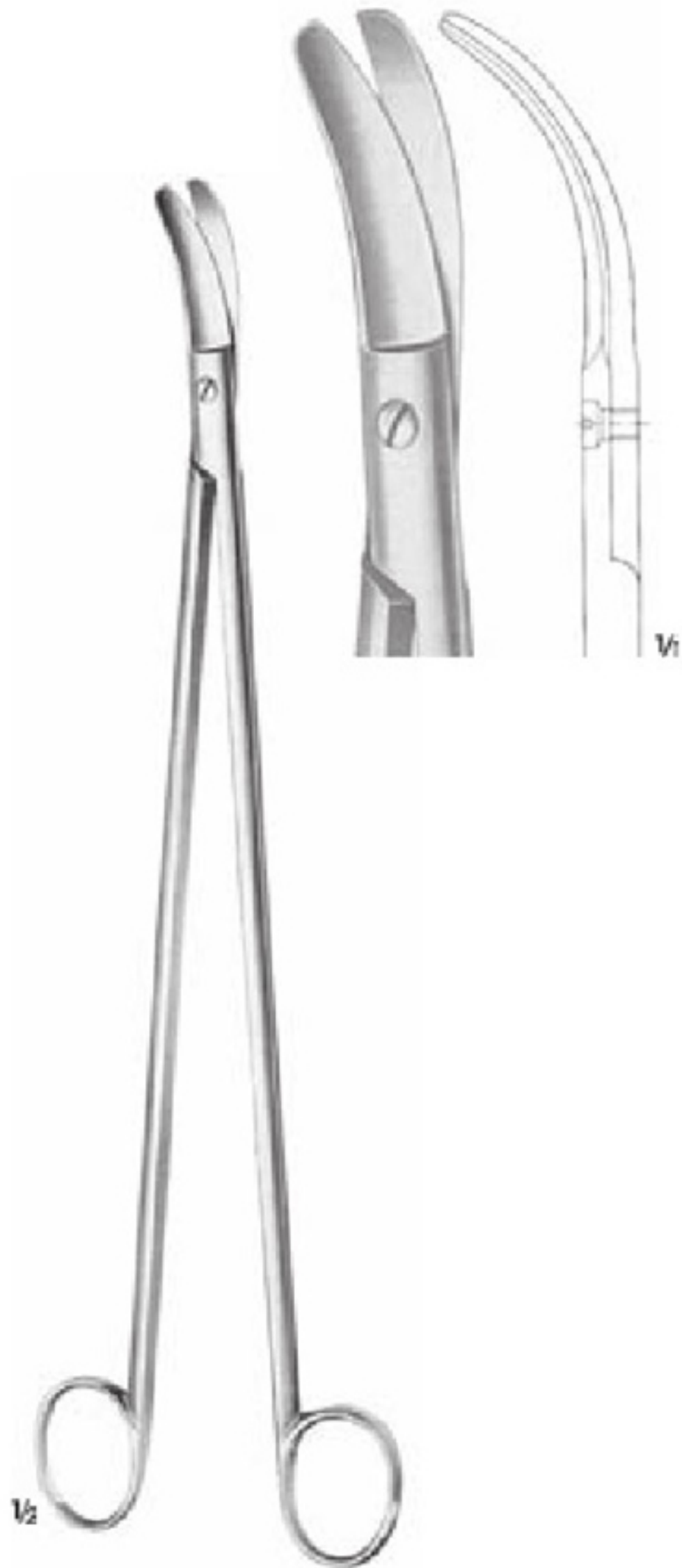

LLOYD-DEVIES(GOLIGHER'S)
EM-03-286
Rectal scissors
25.5 cm



EM-03-287
Straight

EM-03-288
Curved

STELZNER
EM-03-287 - 288
Rectal scissors
31 cm

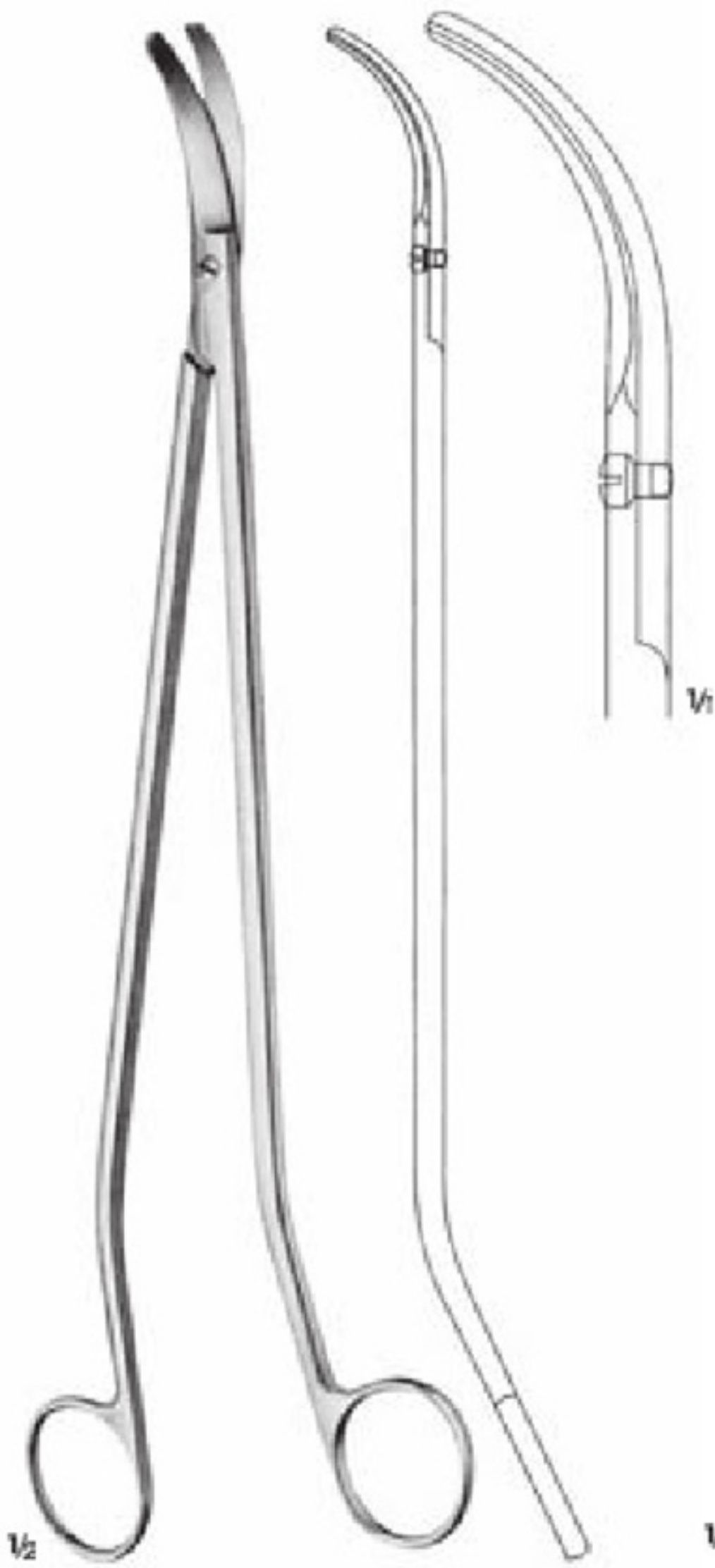

EM-03-289
Rectal scissors
S-shaped
32.5 cm

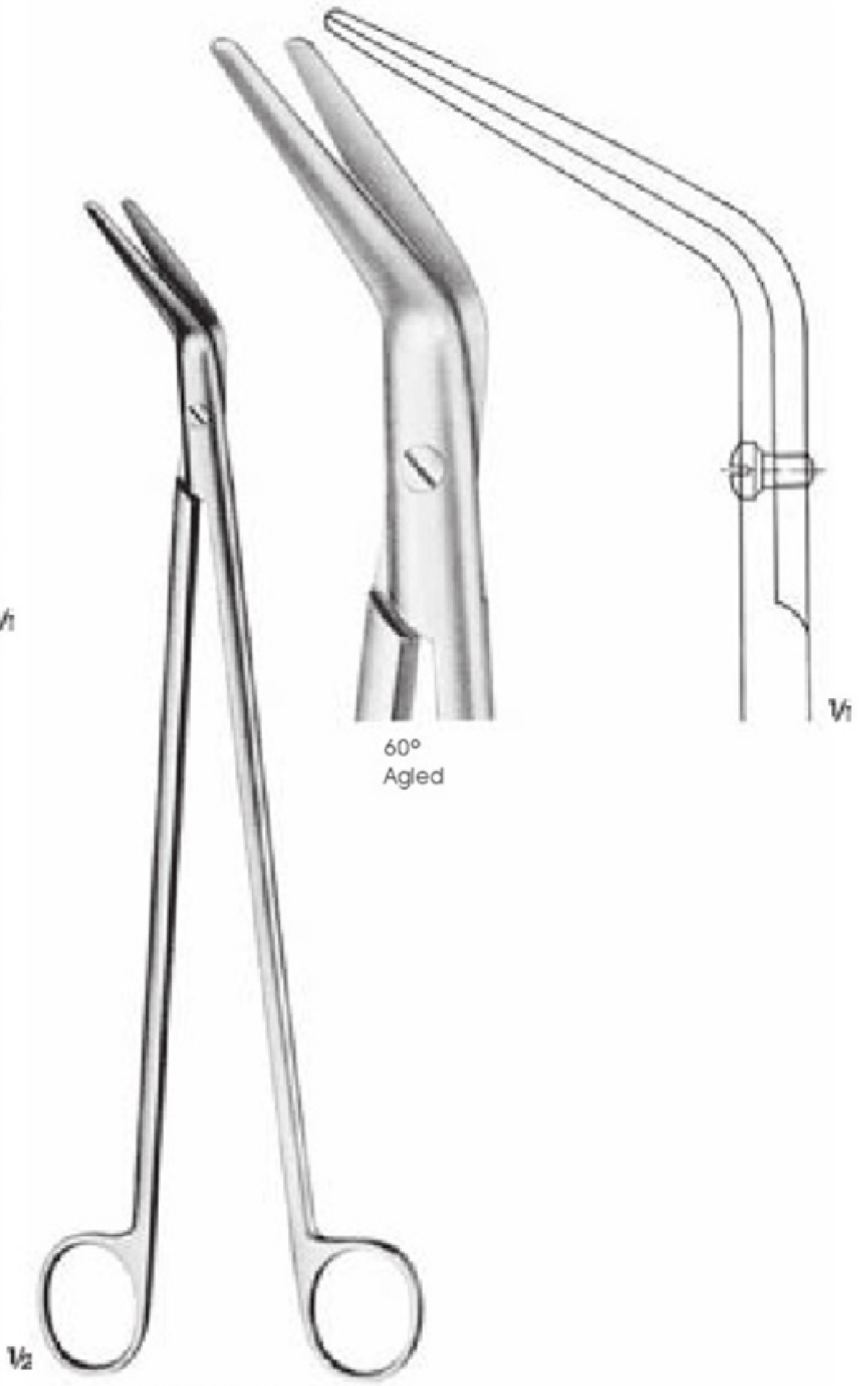

EM-03-290
Dissecting scissors for cutting
of the bowel after suturing with
suture device
28 cm



KIEBACK
 EM-03-291 - 292
 Parametrium scissors

EM-03-291 24 cm EM-03-292 35 cm

KEIBACK
 EM-03-293-01 - 293-02
 Parametrium scissors, curved to side,
 with one probe pointed blade

EM-03-293-01 26 cm EM-03-293-02 35 cm



1/2



1/2



1/2

BOZEMANN
EM-03-294
Uterine scissors
22 cm

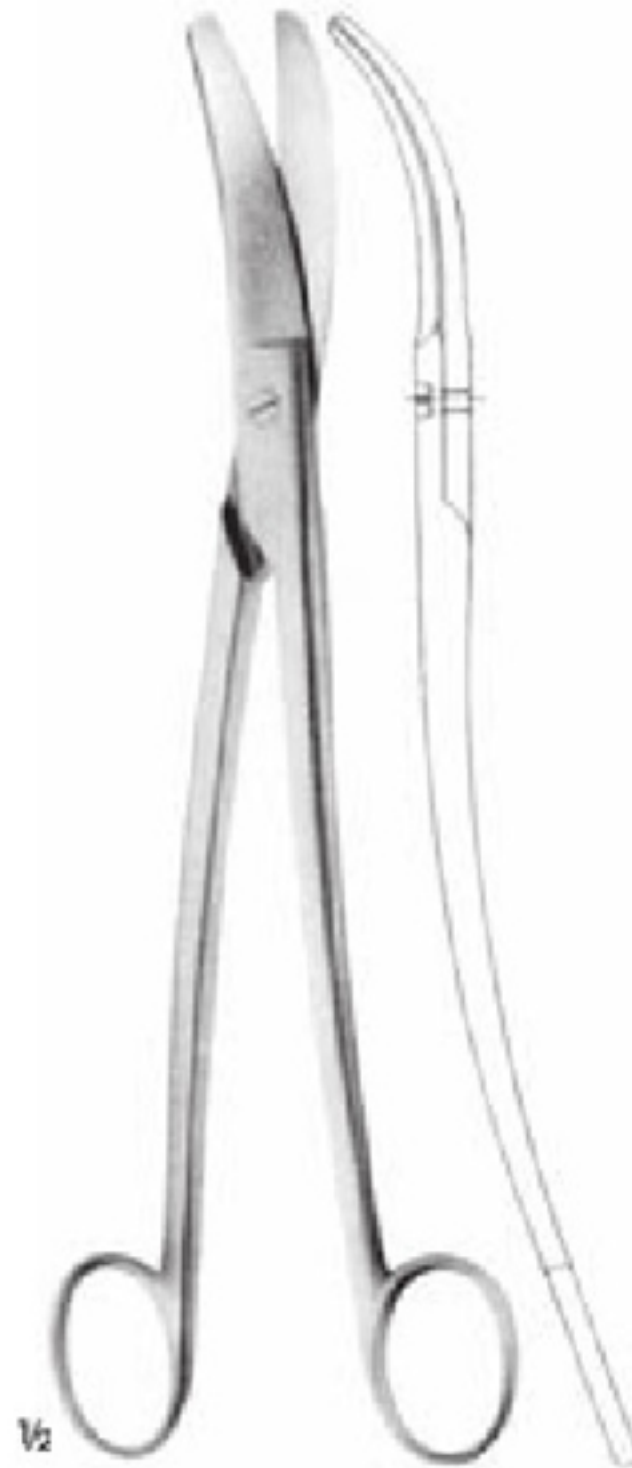

1/2

SIEBOLD
EM-03-295
Uterine scissors
24.5 cm

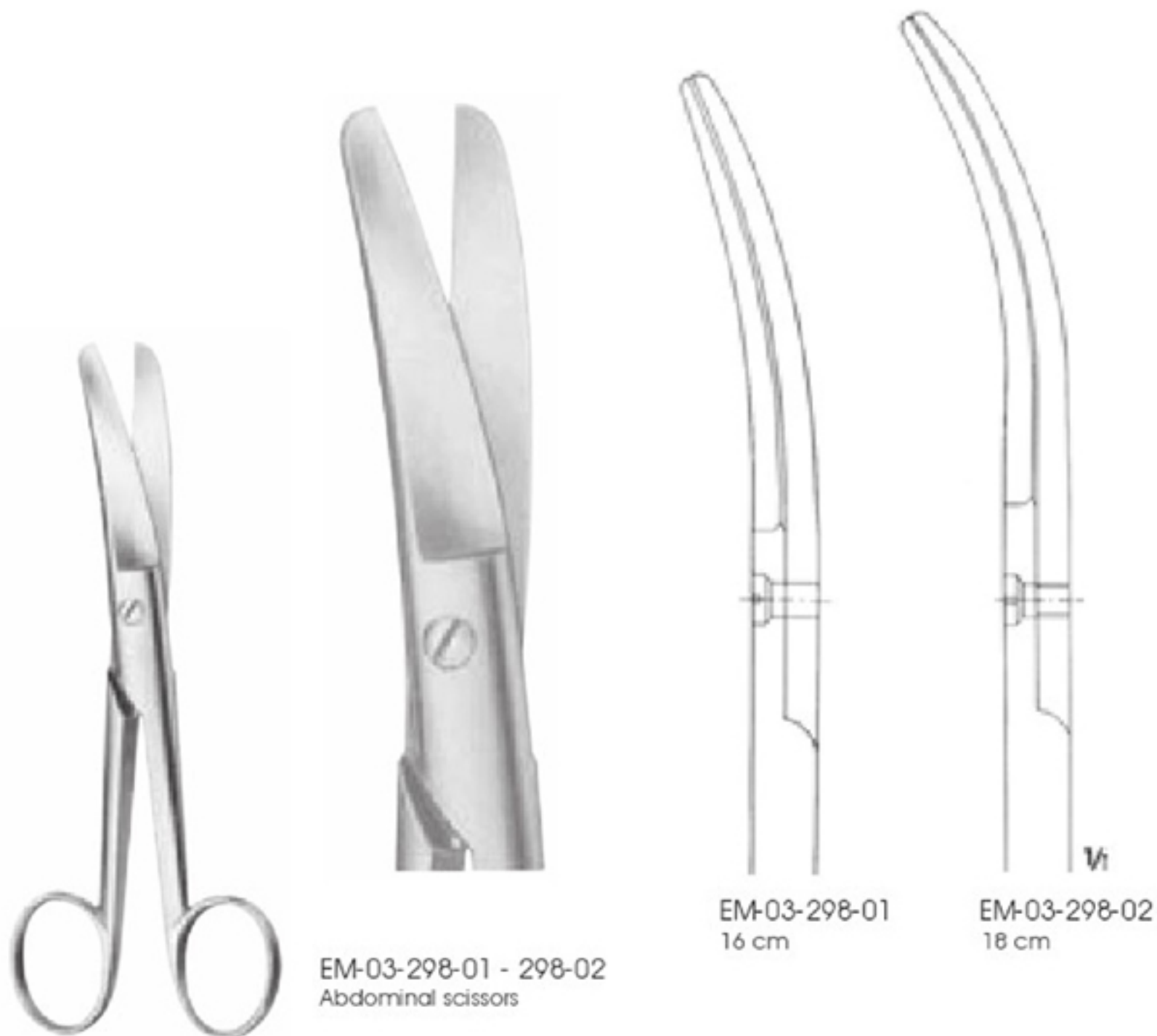

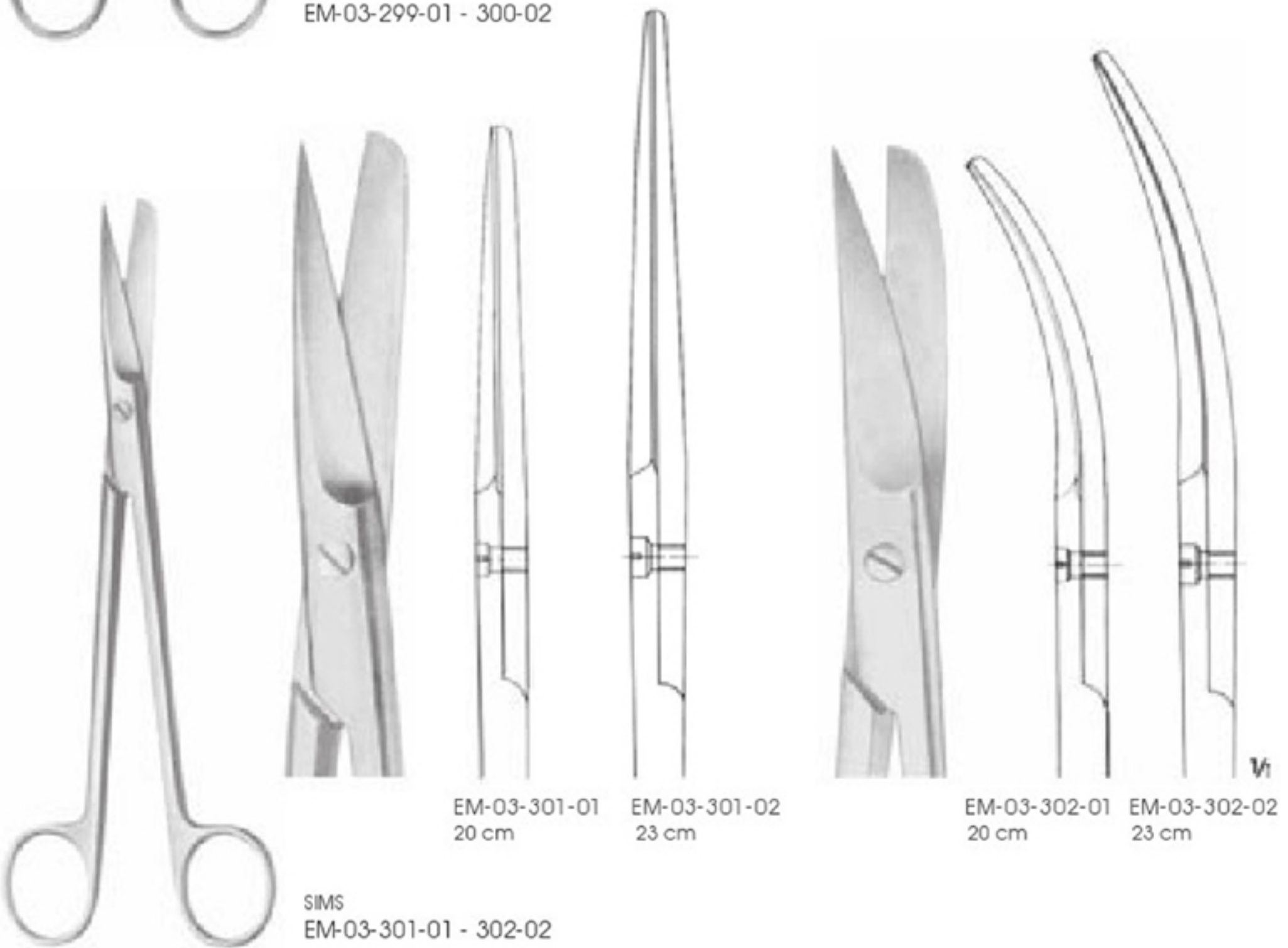
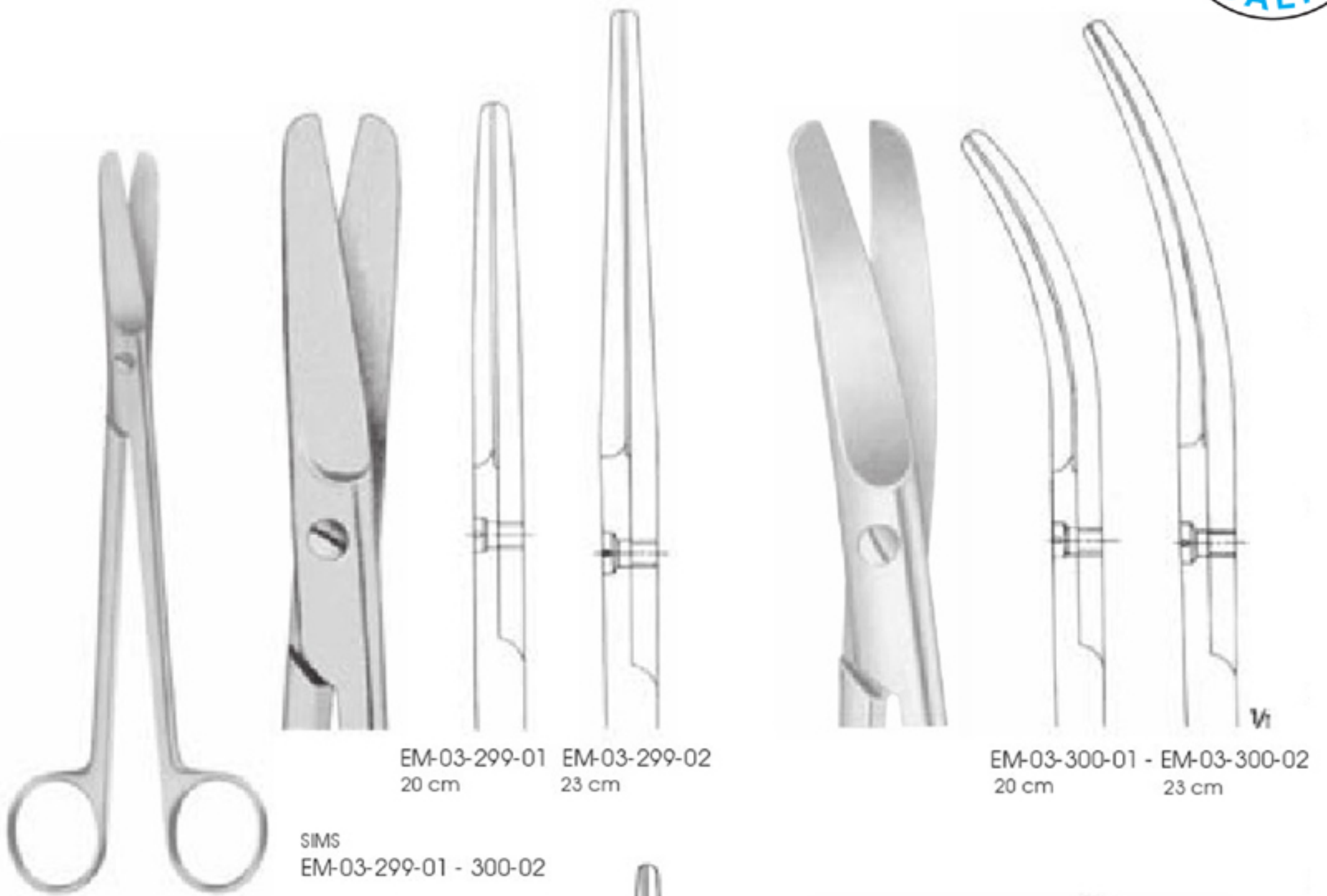

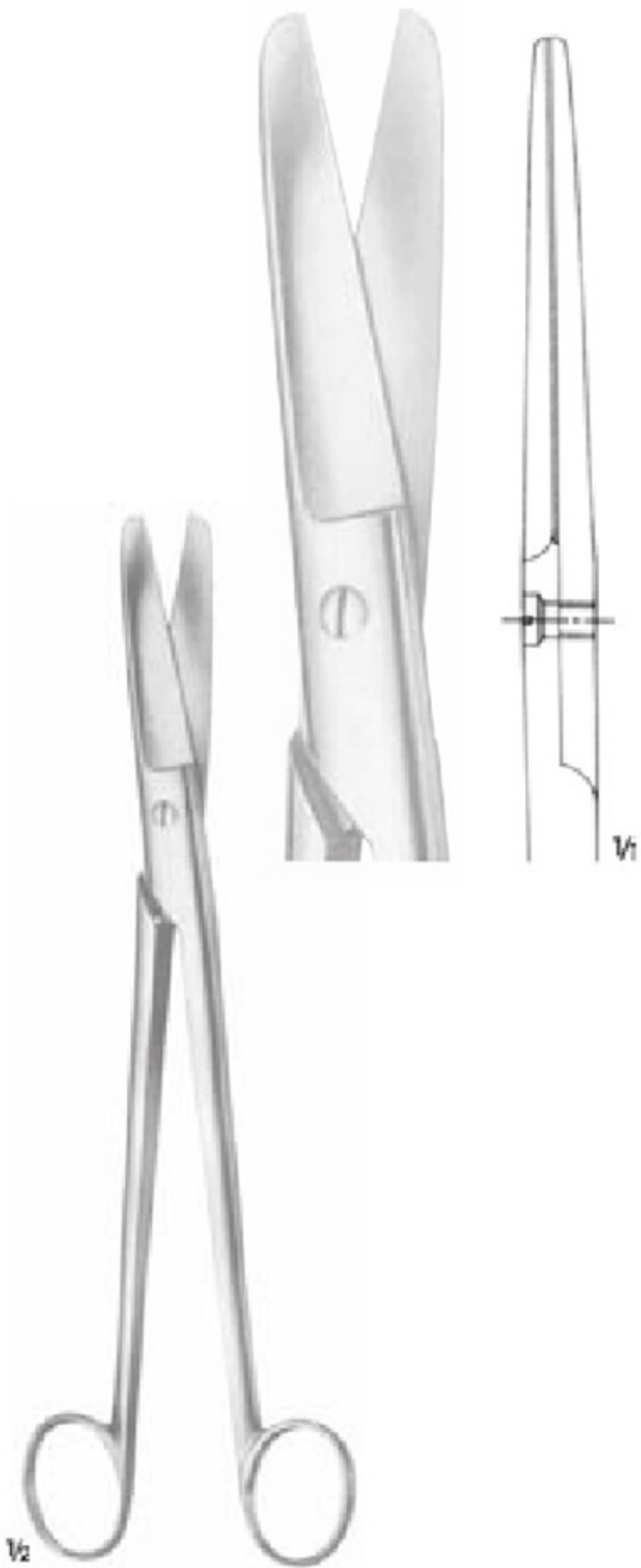

SIMS SIEBOLD
 EM-03-303
 Uterine scissors
 25 cm

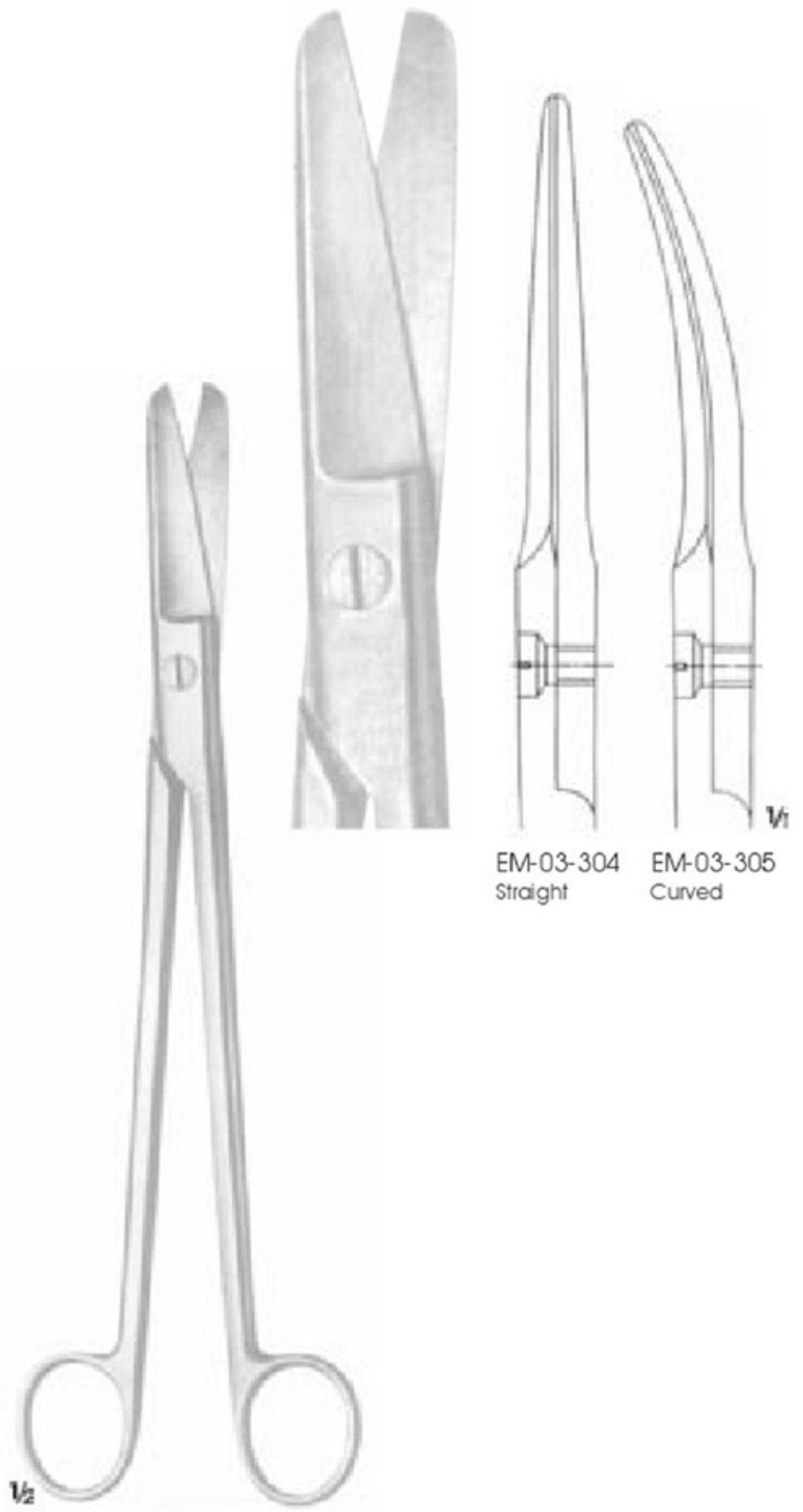

DUBOIS
 EM-03-304 - 305
 Embryo scissors
 27.5 cm

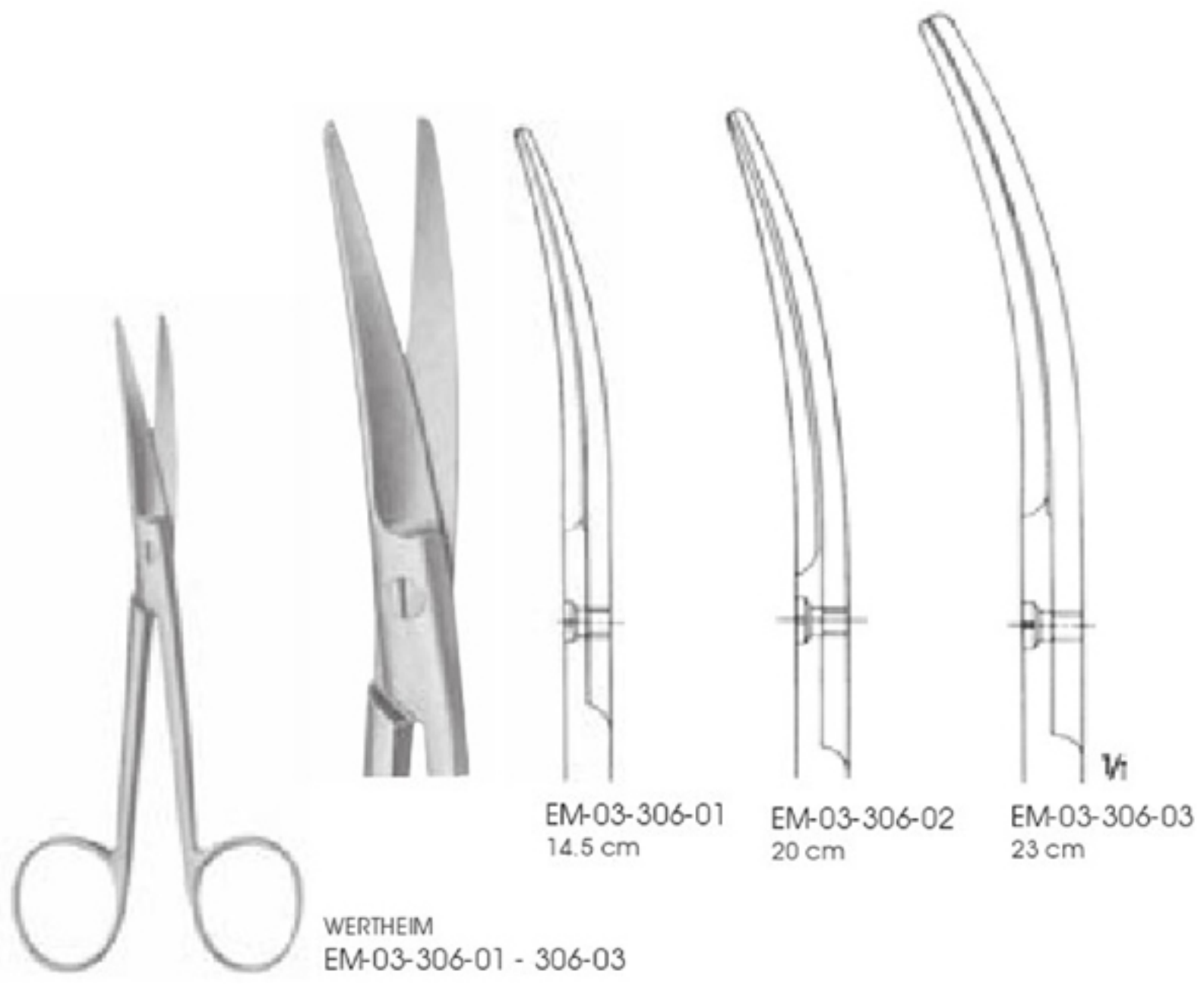

Standart bleyd
Standard blade



EM-03-309-01

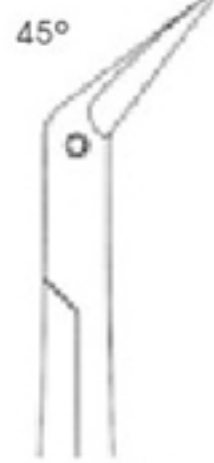

EM-03-309-02



EM-03-309-03



EM-03-309-04



EM-03-309-05

Delicate blade



EM-03-309-06



EM-03-309-07



EM-03-309-08



EM-03-309-09



EM-03-309-10

Ultra hassas bleyd
Ultra delicate blade



EM-03-309-11



EM-03-309-12



EM-03-309-13



EM-03-309-14



EM-03-309-15

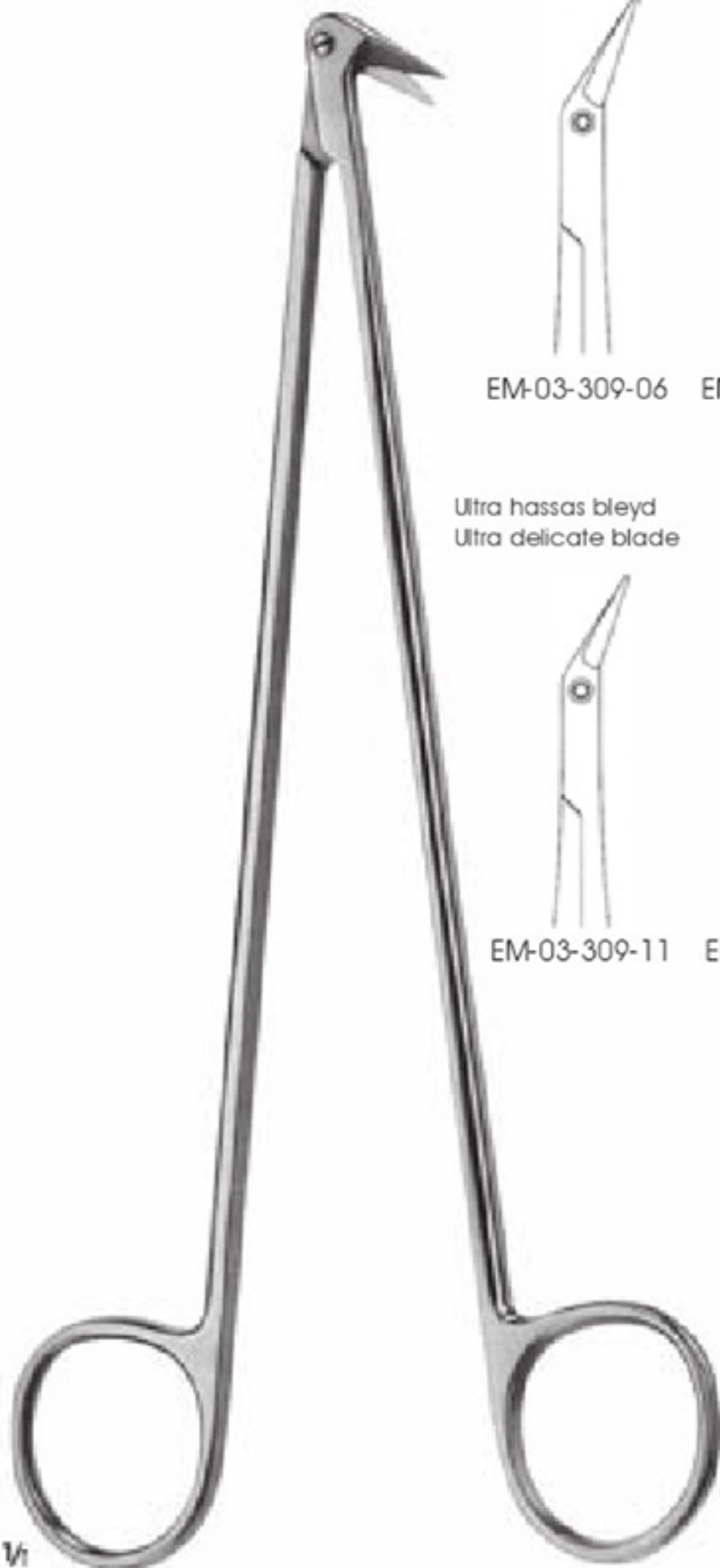

EM-03-309-01 - 309-15
18 cm

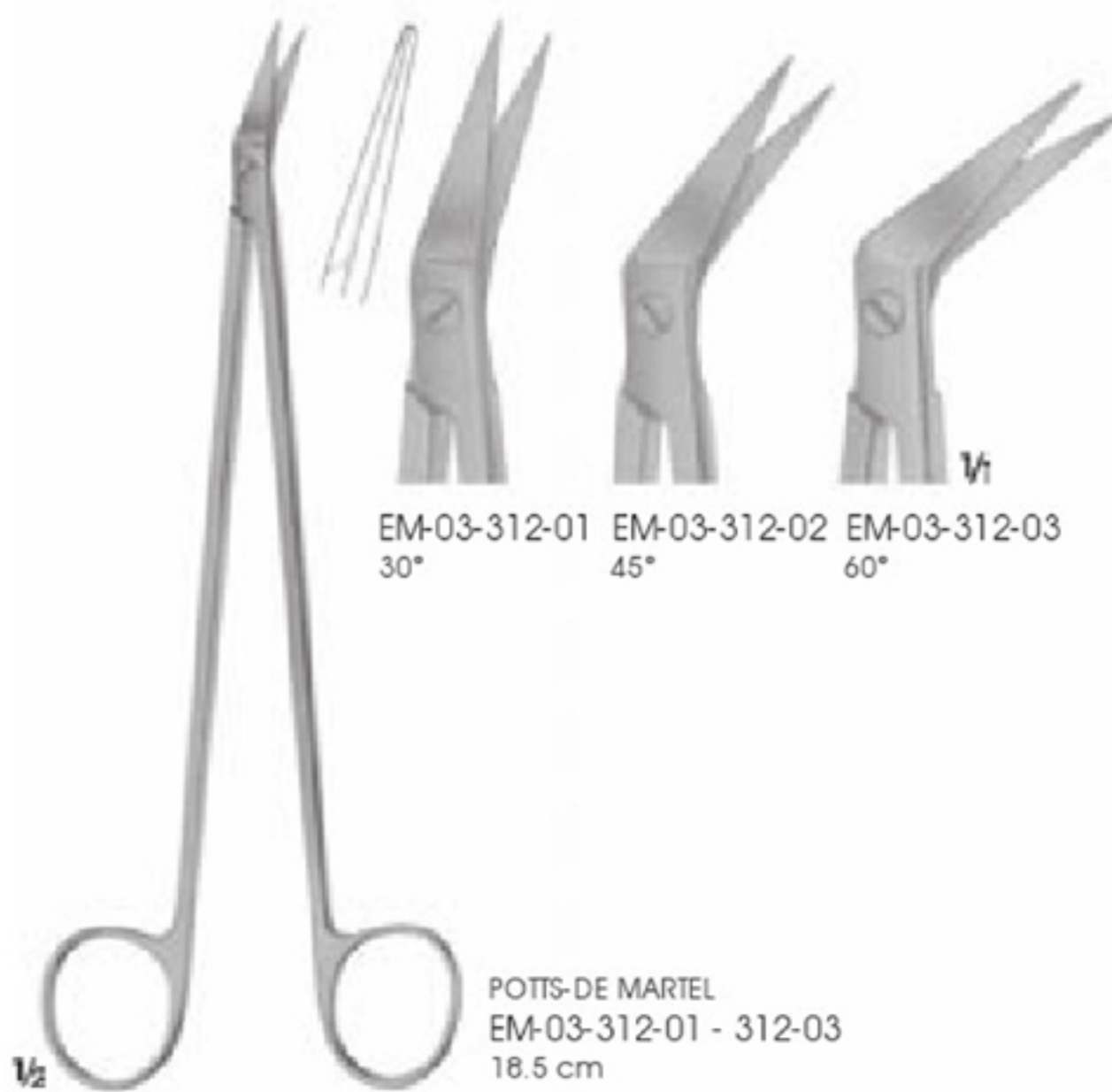
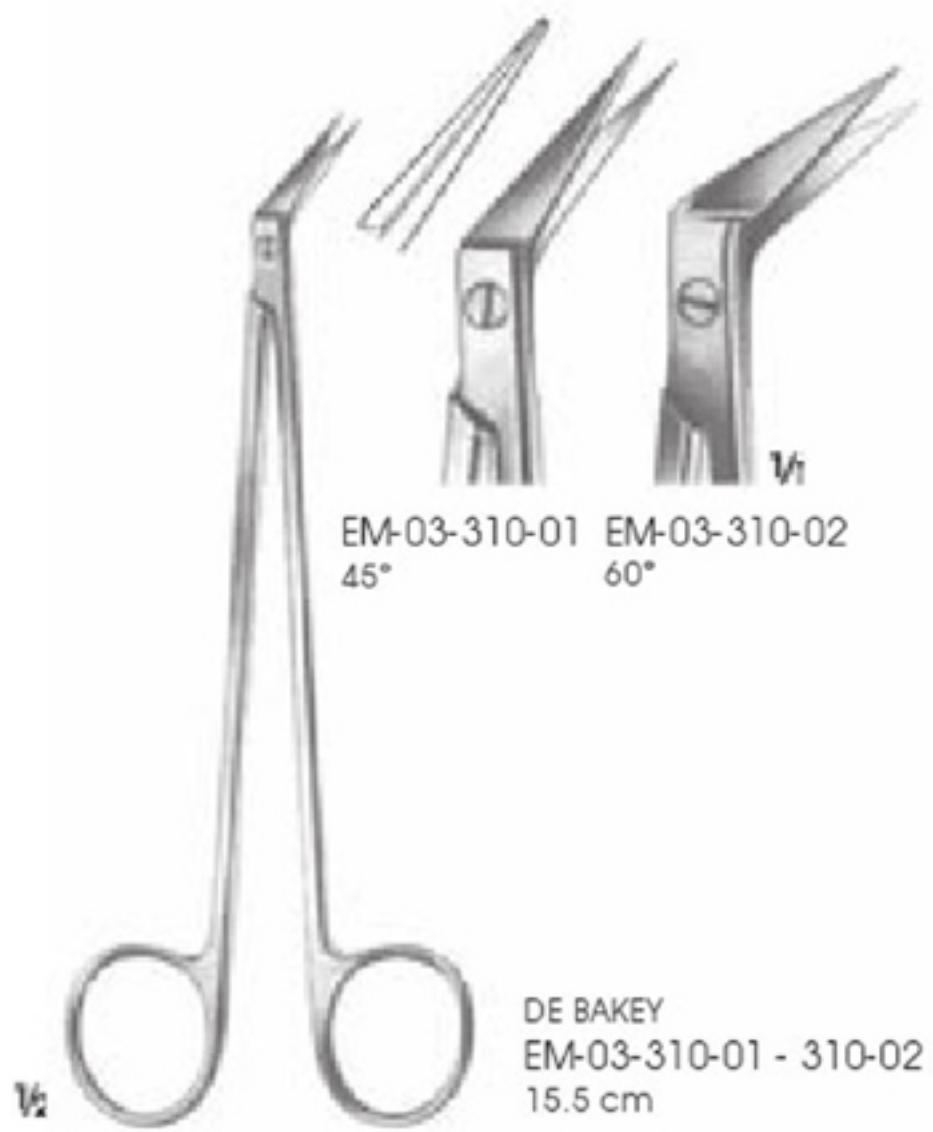

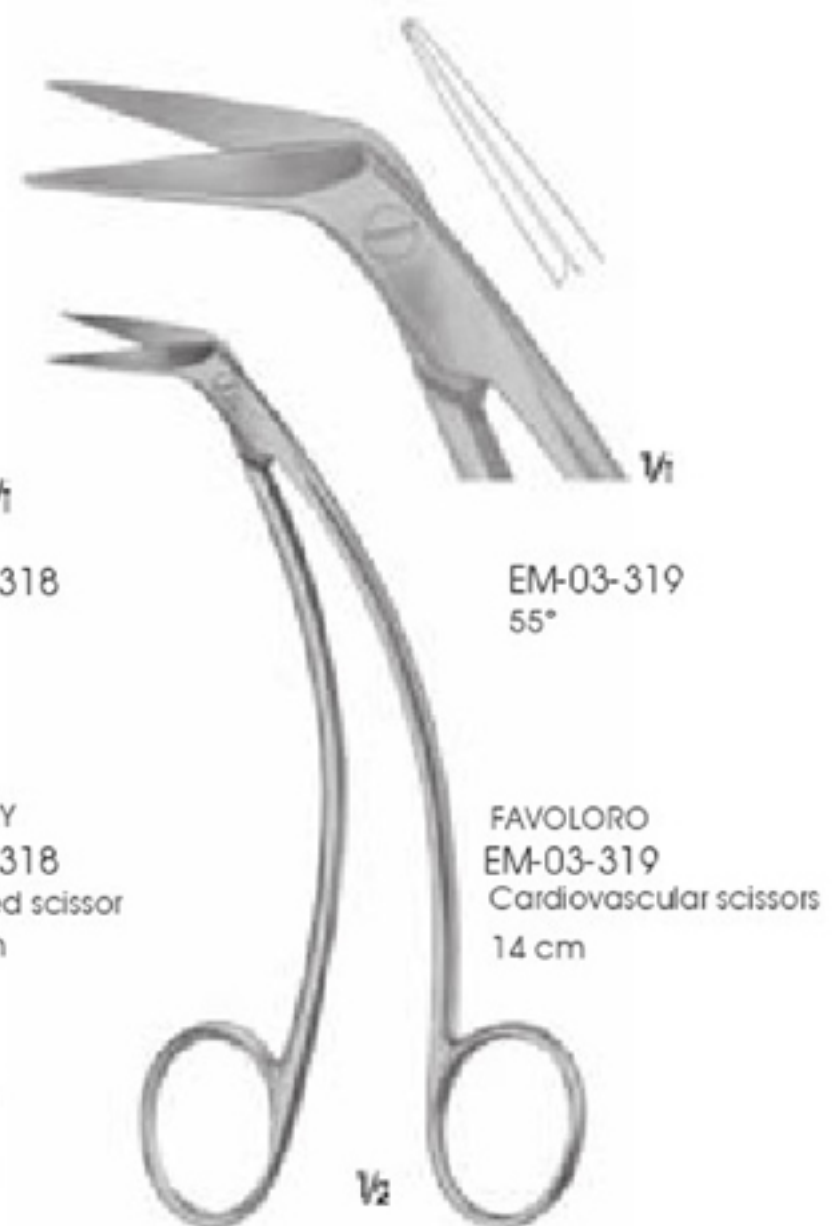
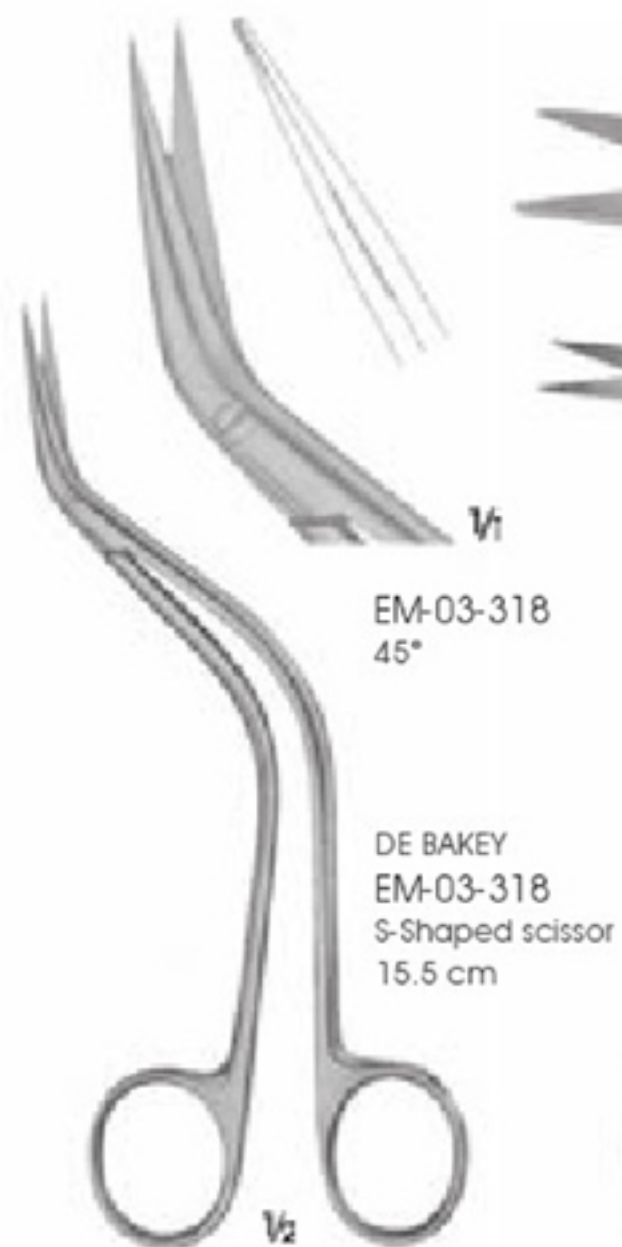
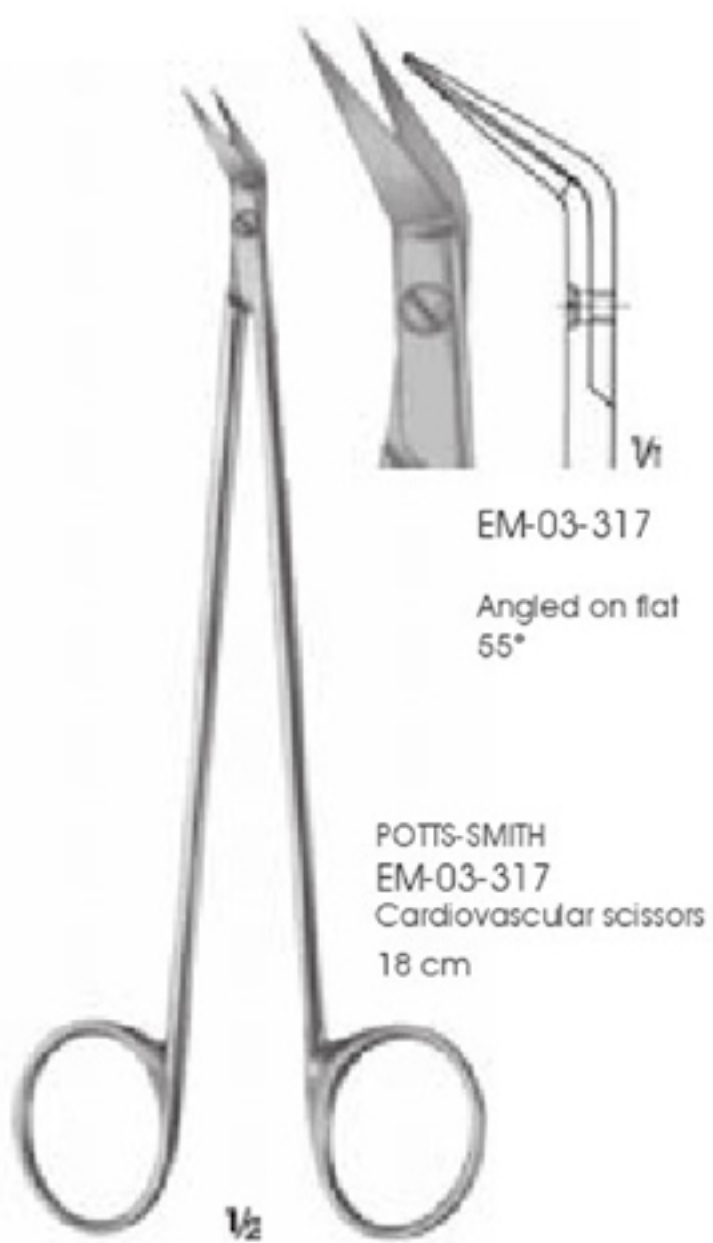
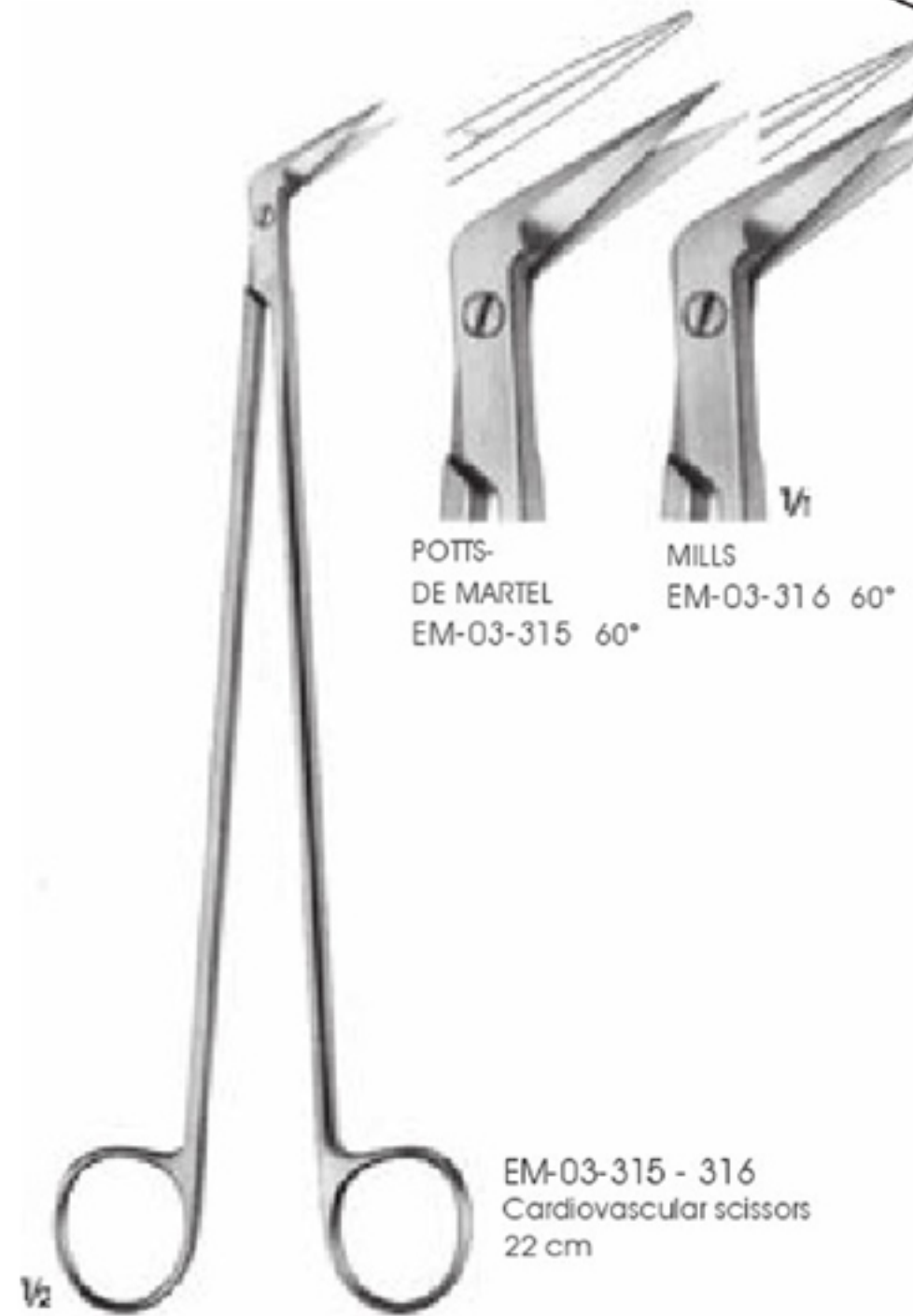
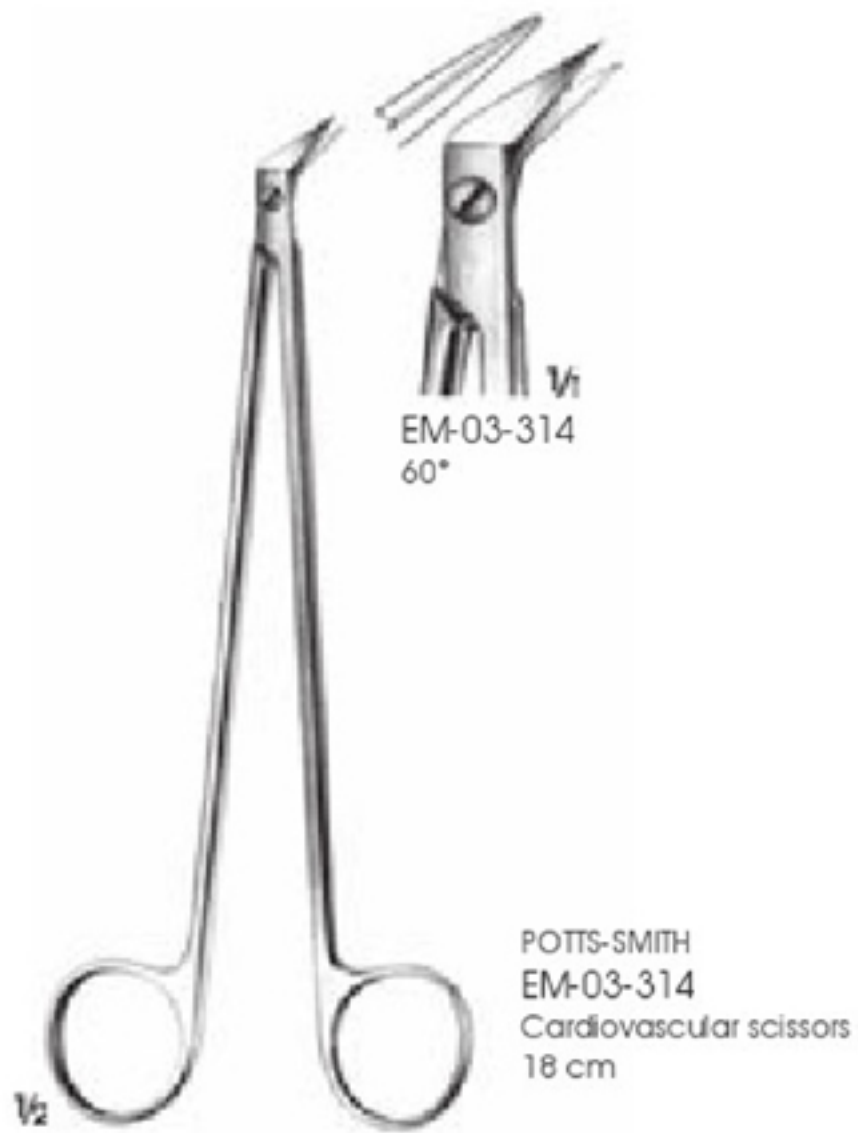

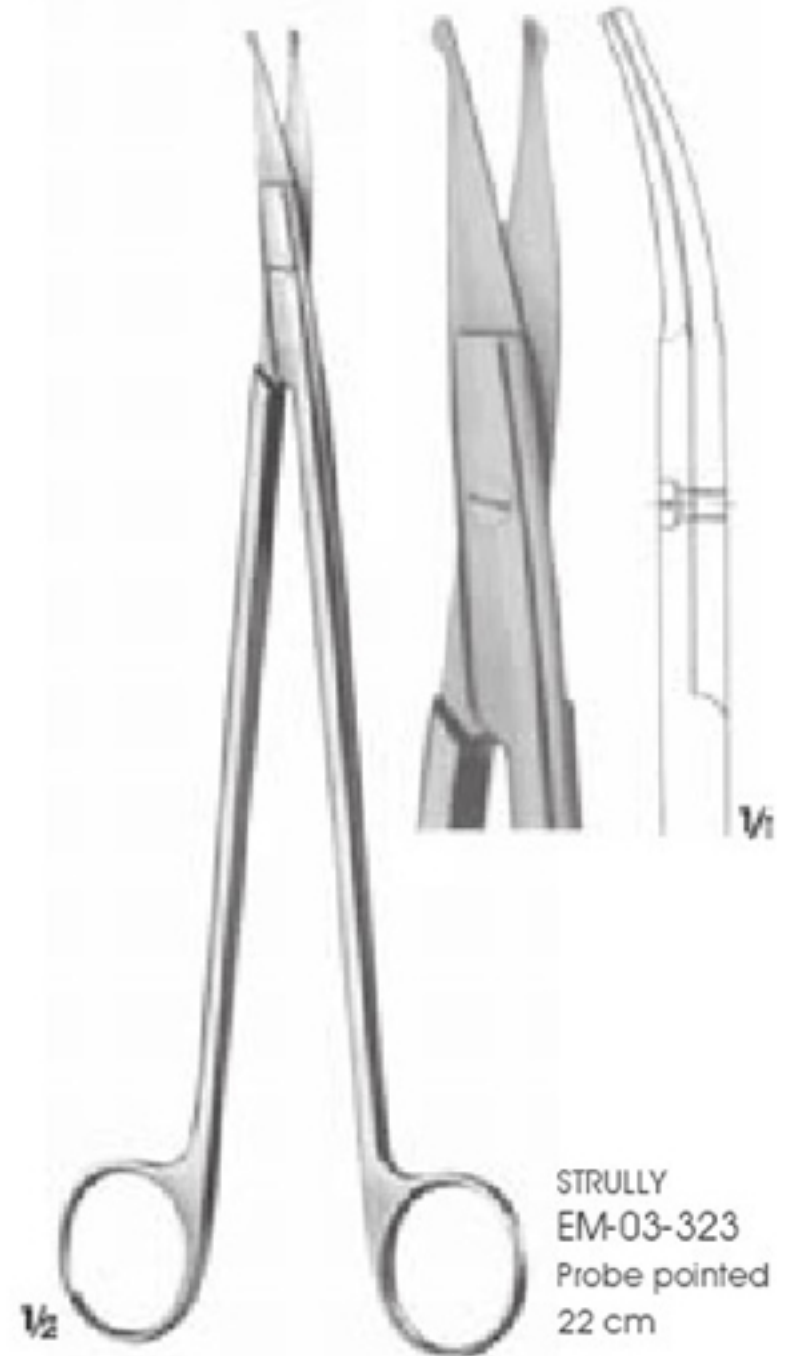
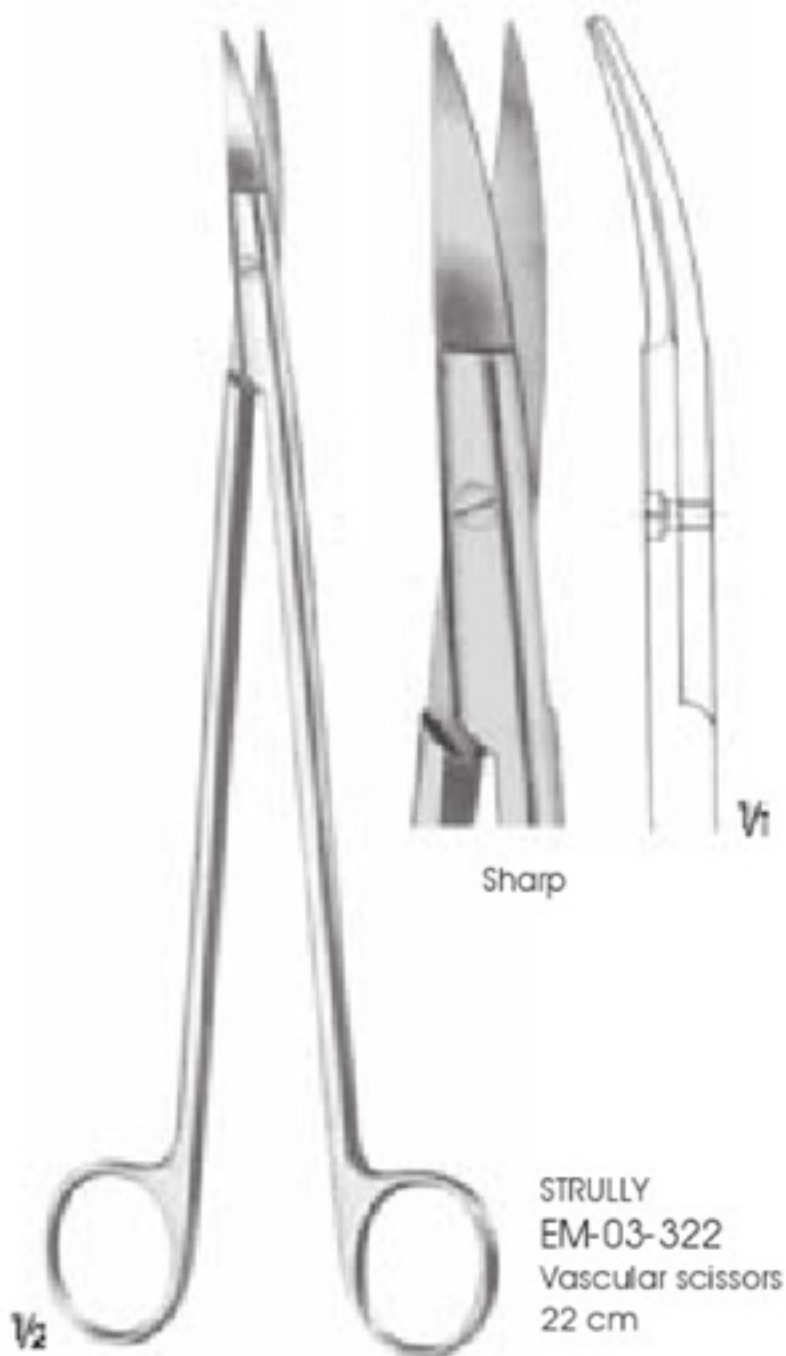
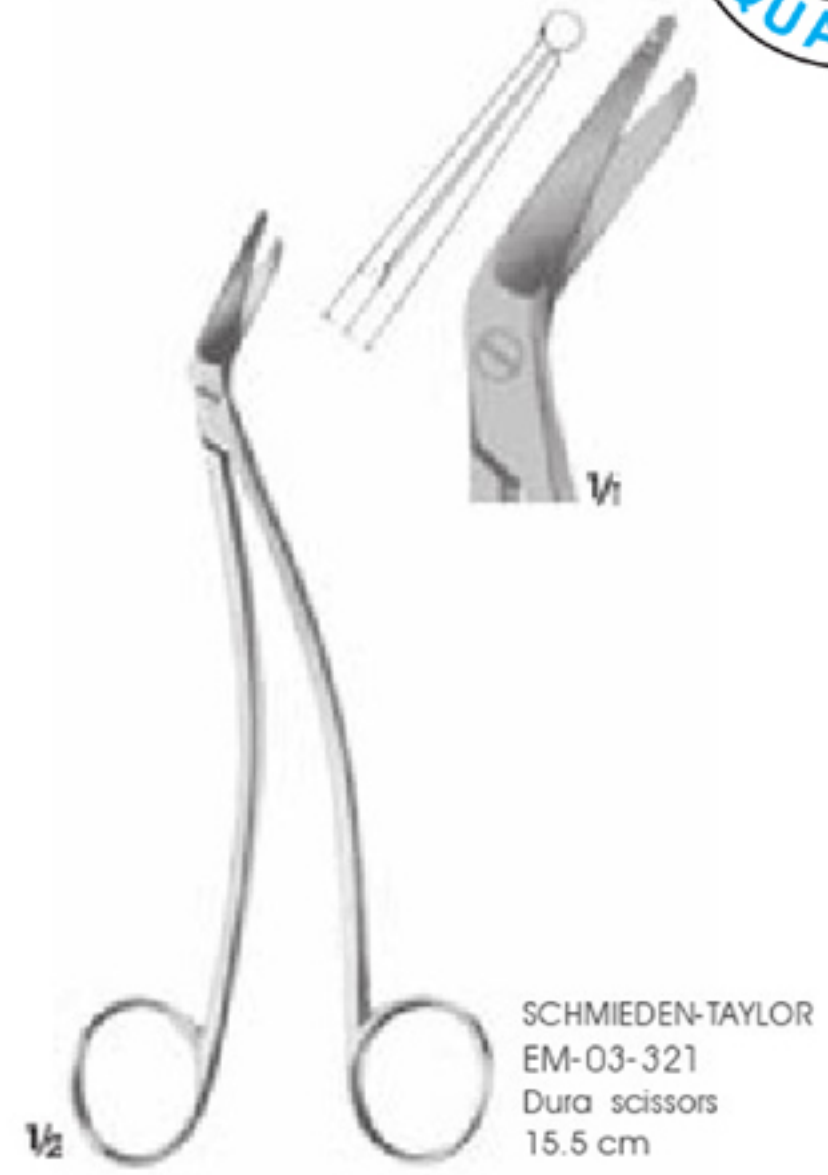
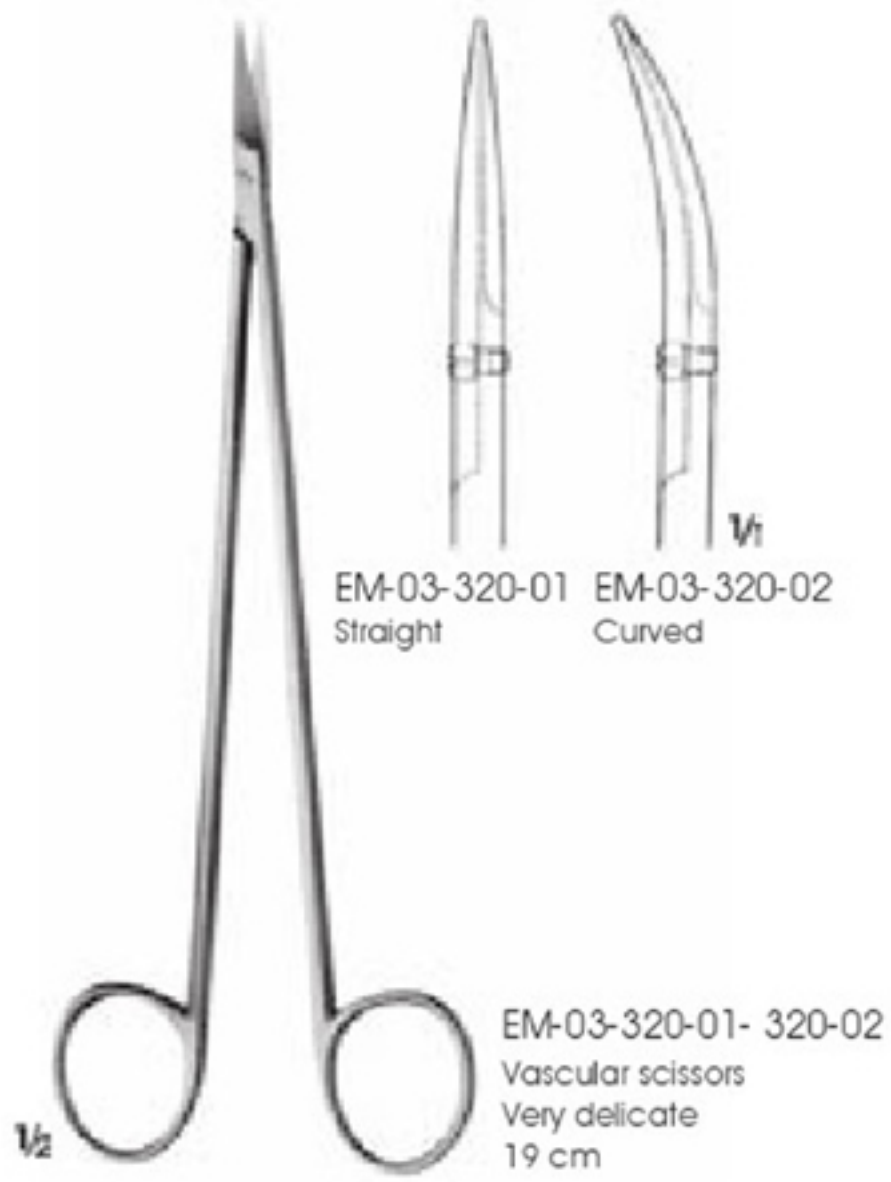

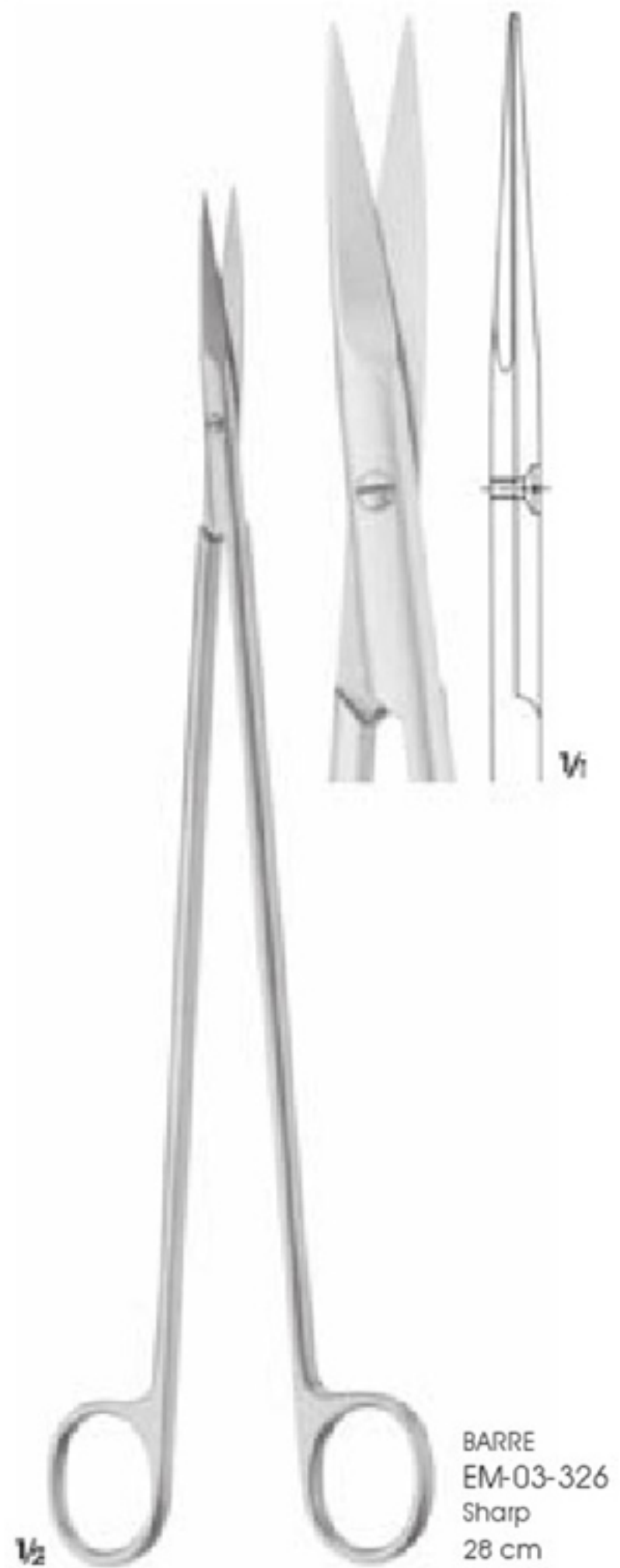
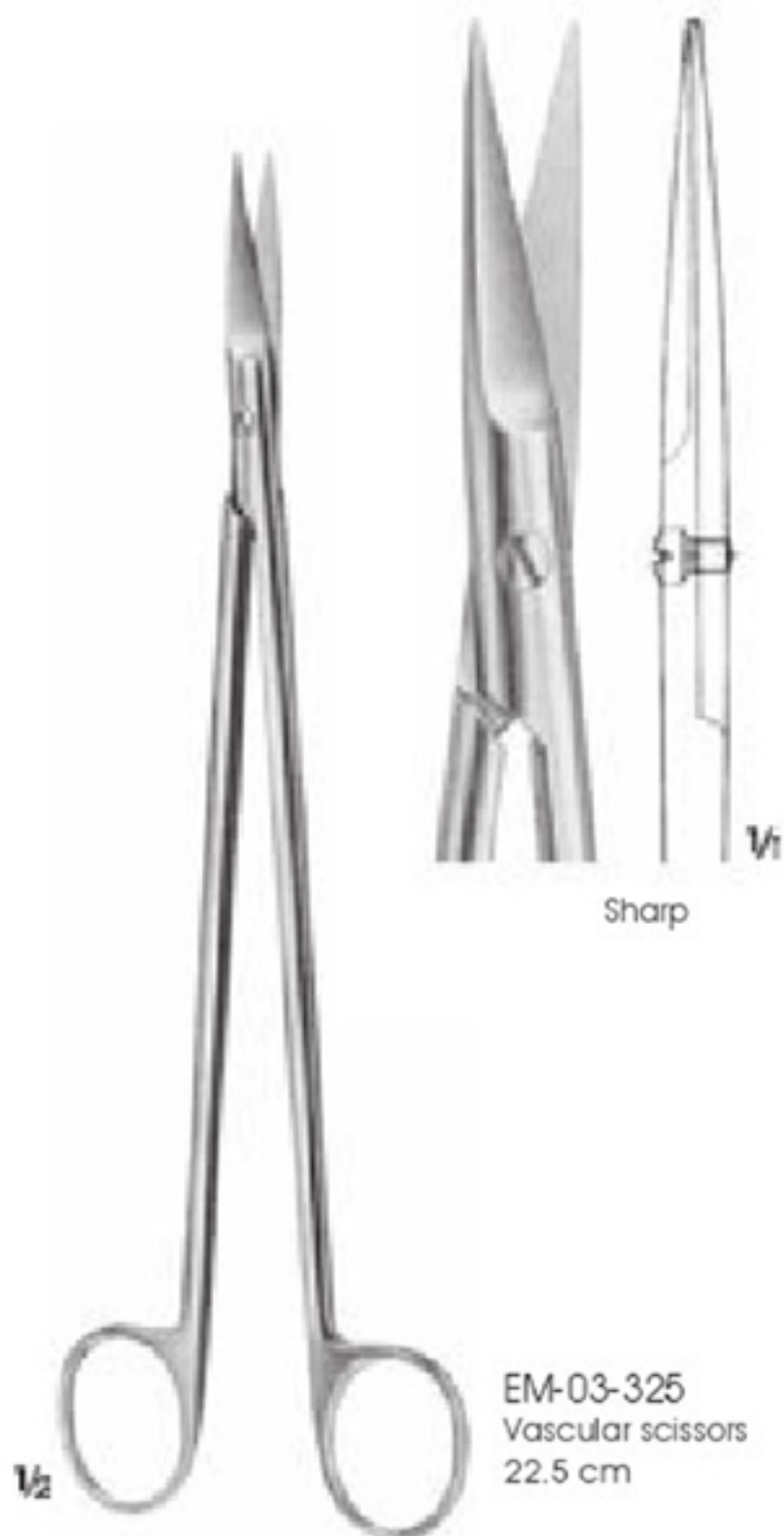
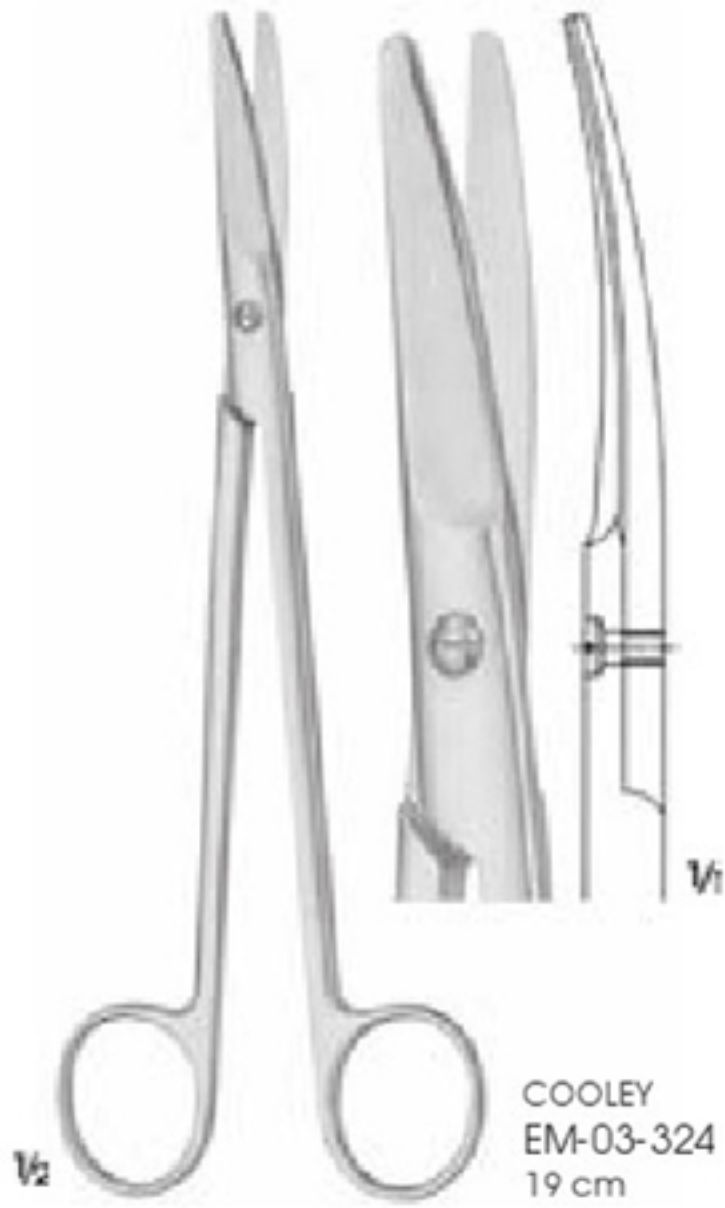

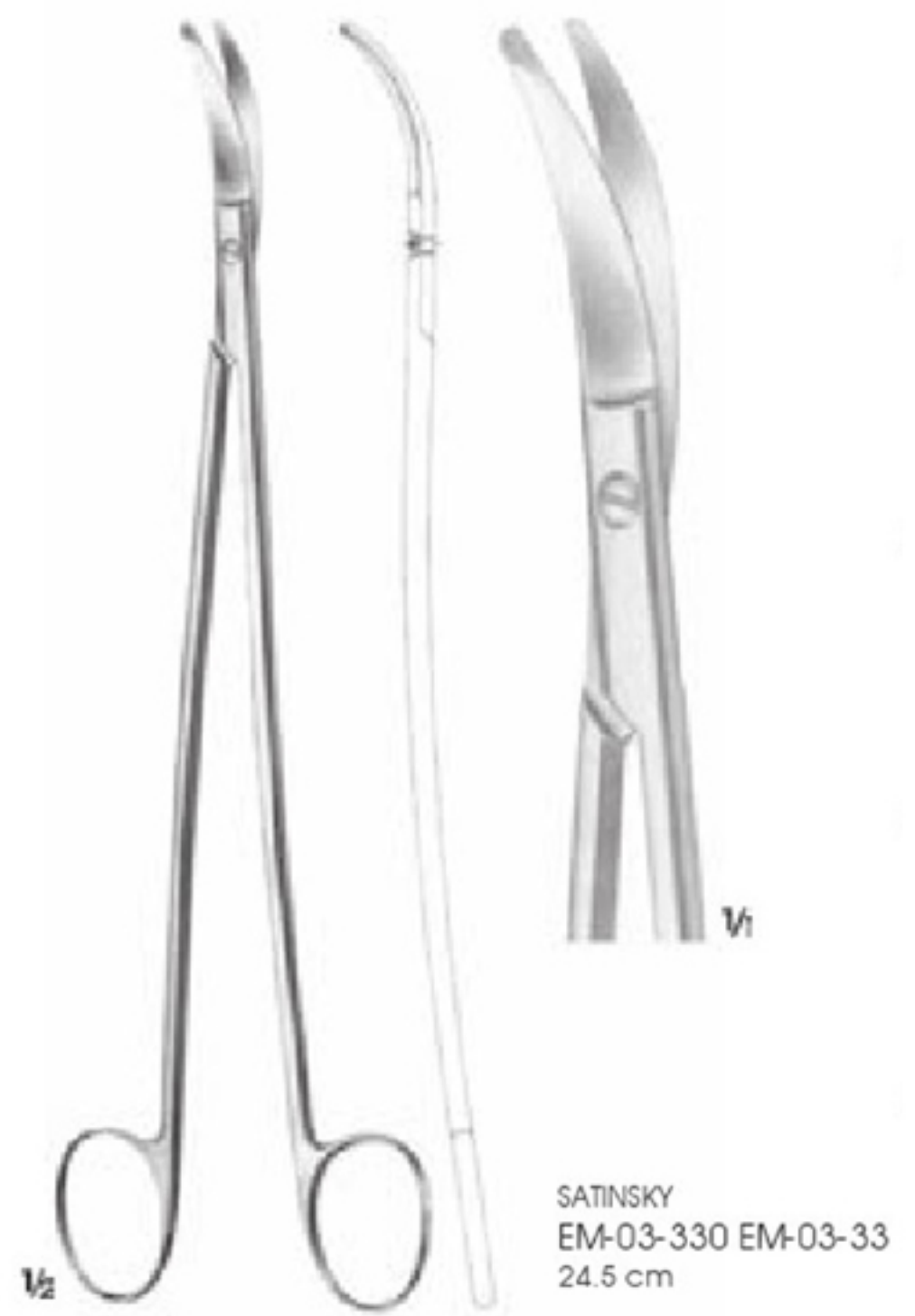
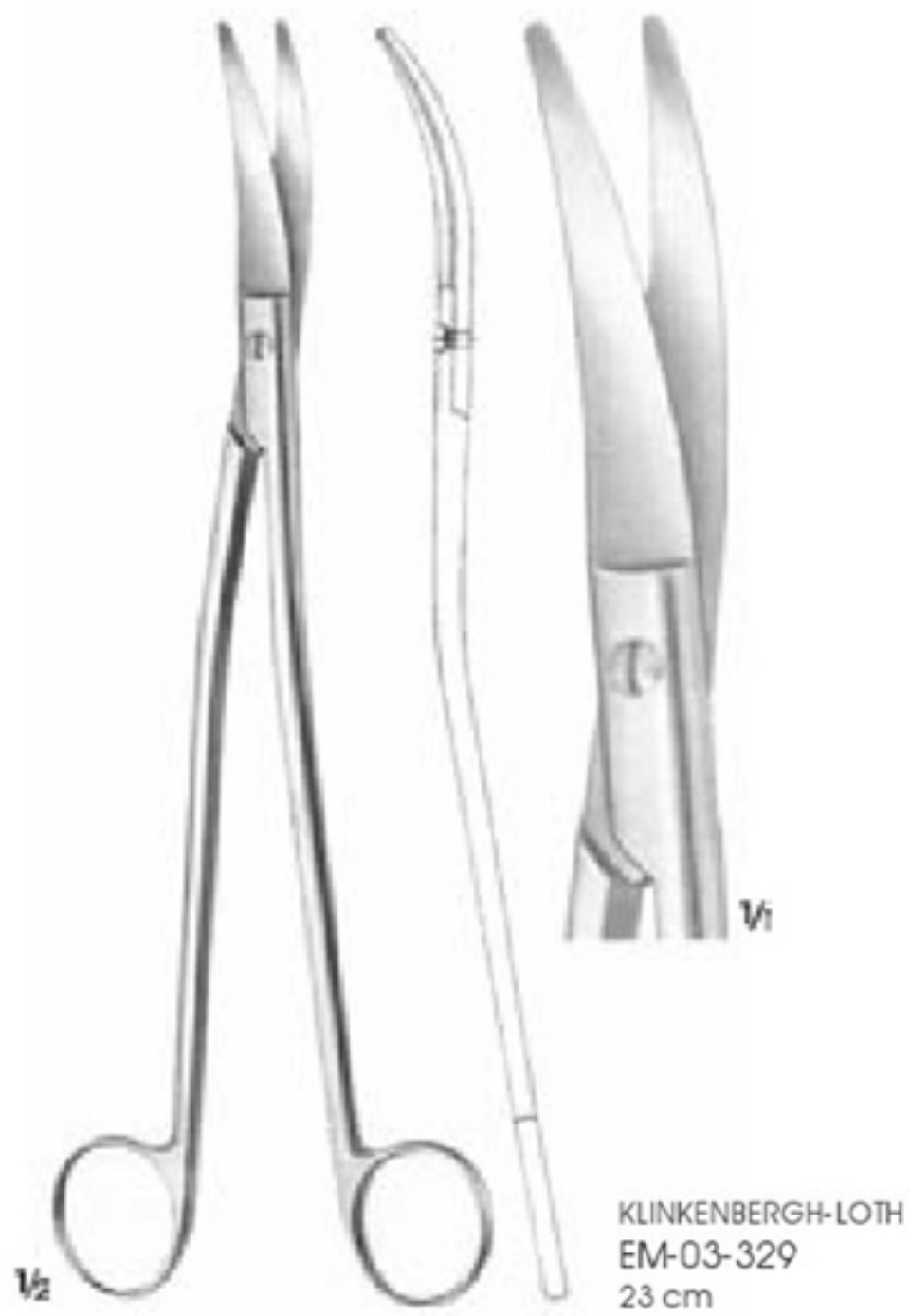
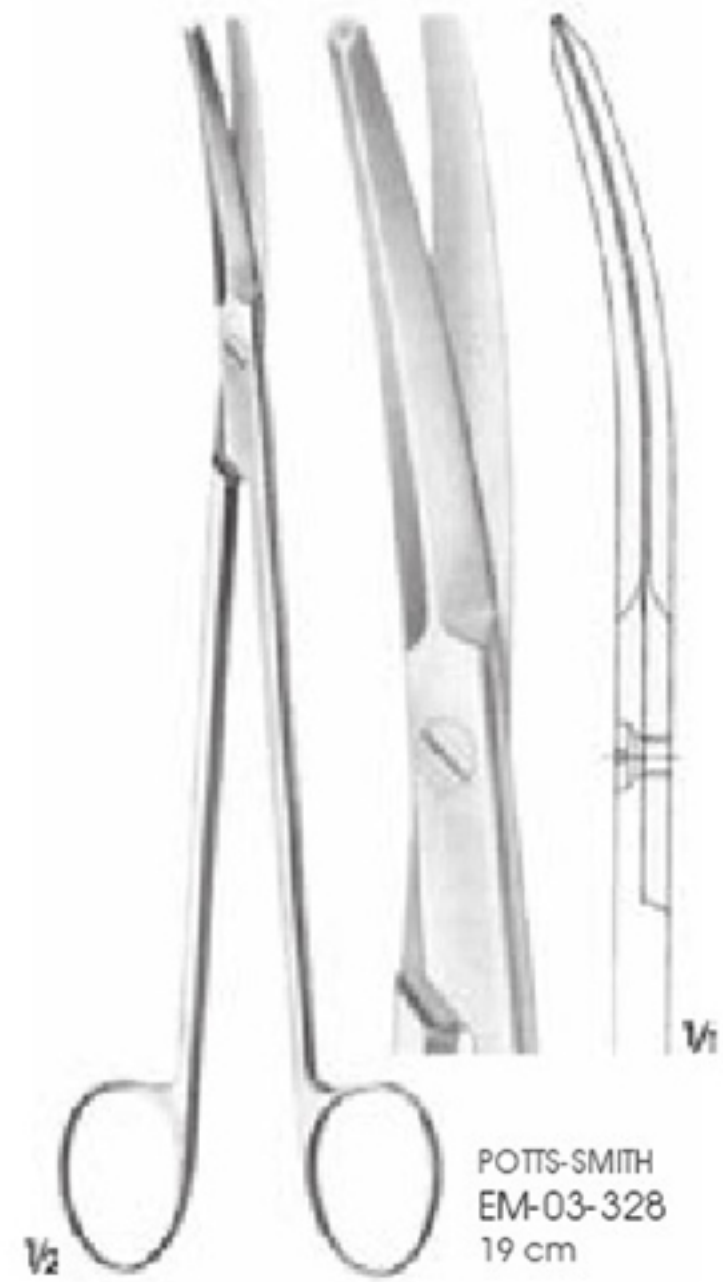
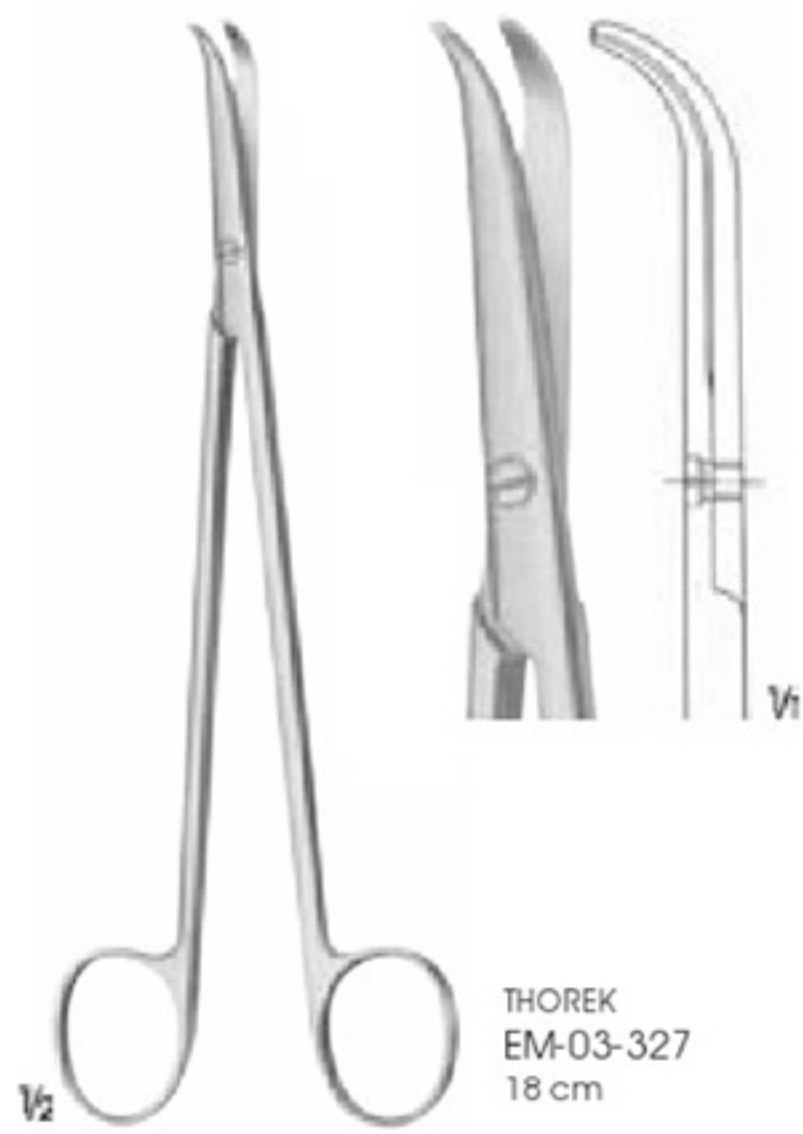

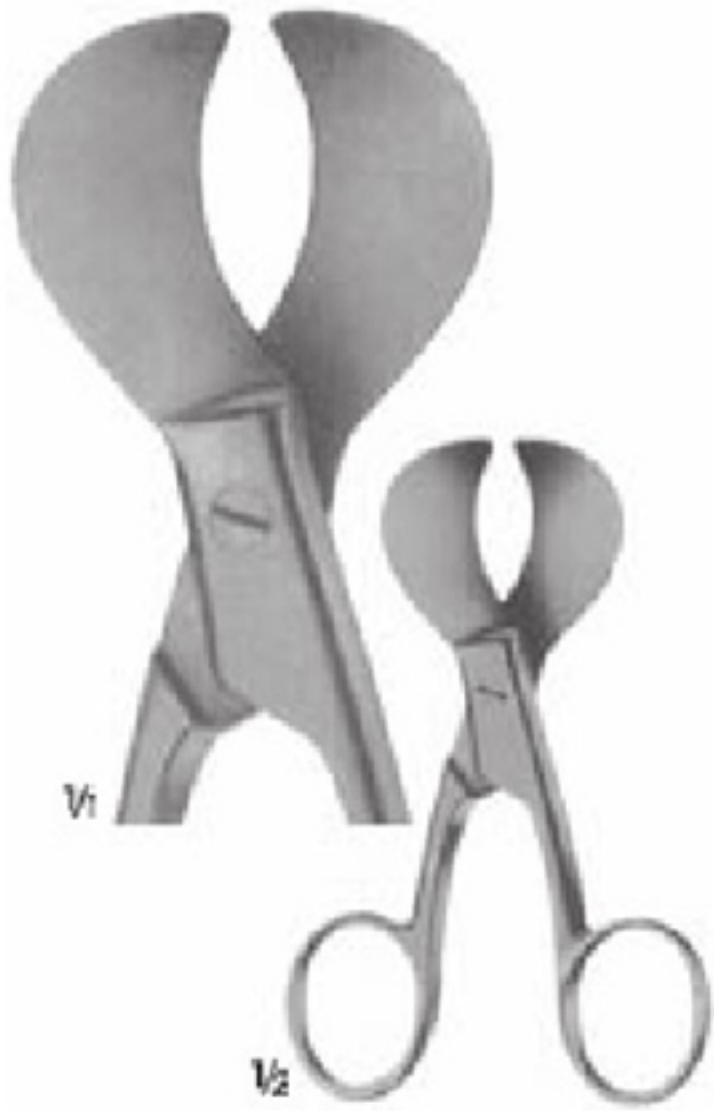

EM-03-331
Umbilical cord scissors
10.5 cm



SCHUMACHER
EM-03-332
Umbilical cord scissors
15.5 cm



EM-03-333-01 - 333-02
Umbilical Cord scissors

EM-03-333-01 13.5 cm
EM-03-333-02 16 cm



EM-03-334-01
14.5 cm



EM-03-334-02
20 cm

BRAUN-STADLER
EM-03-334-01 - 334-02
Episiotomy scissors



EM-03-335
Episiotomy scissors
24 cm

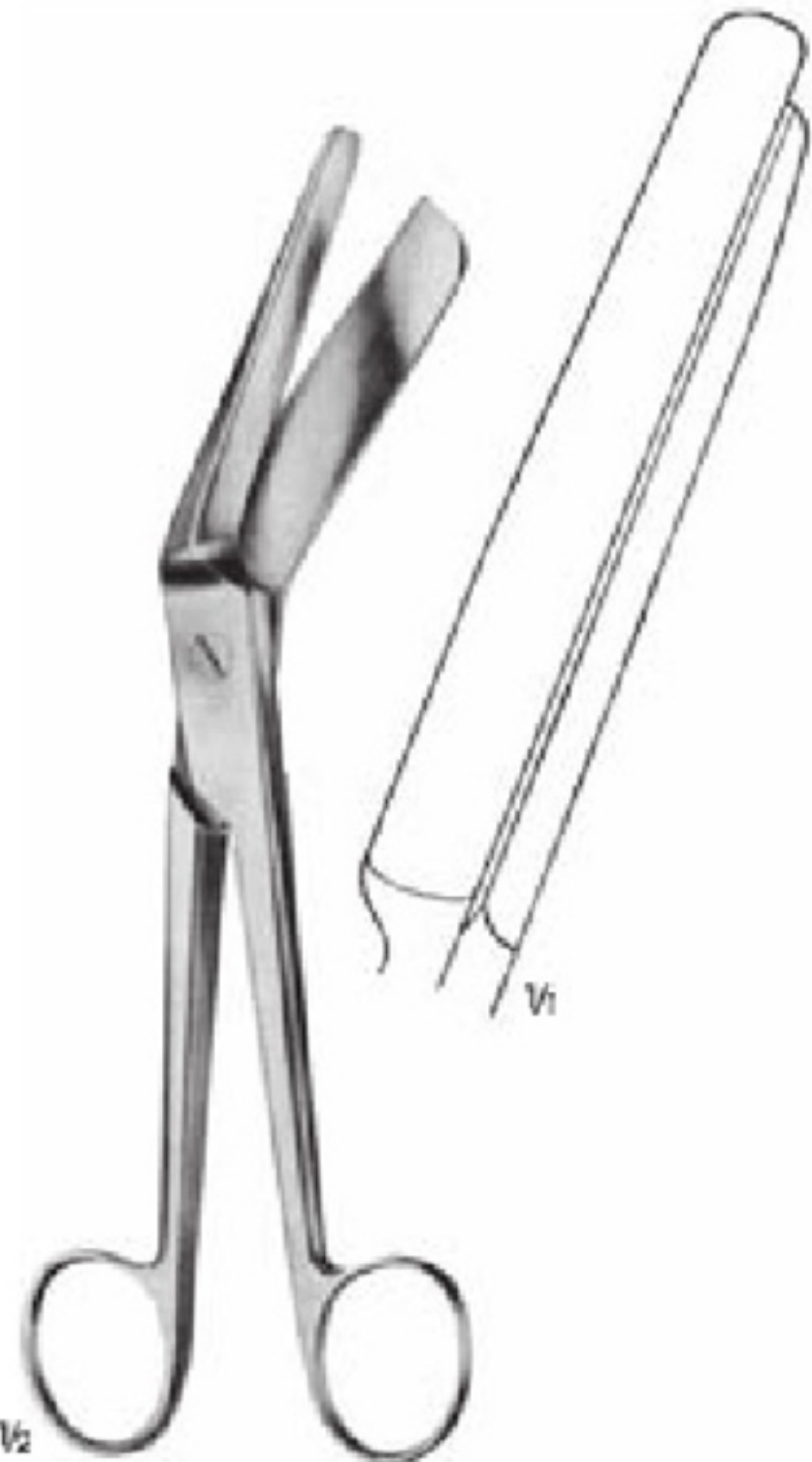

BRAUN-STADLER
EM-03-336
Bandage scissor
22.5 cm

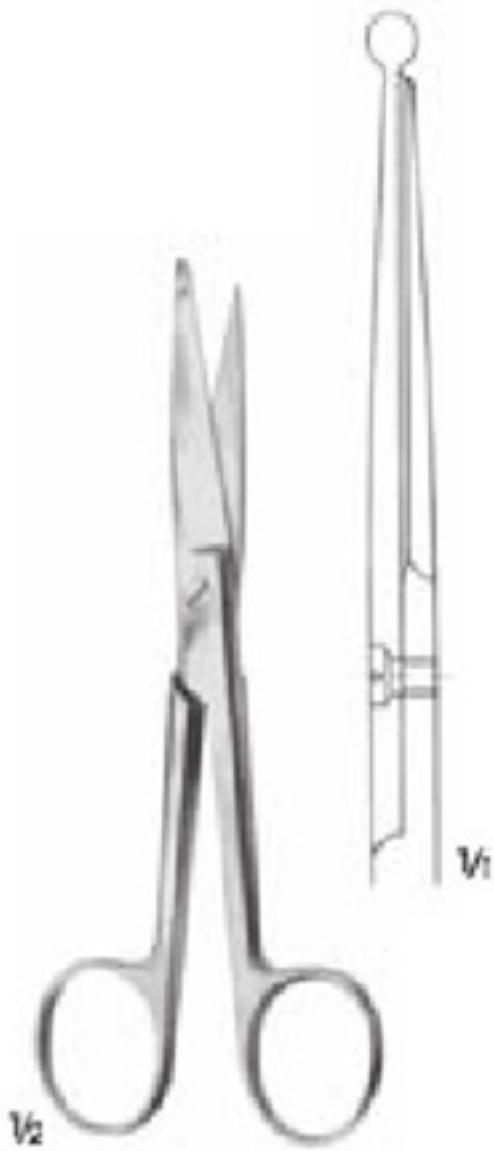

KNOWLES
 EM-03-337
 14.5 cm

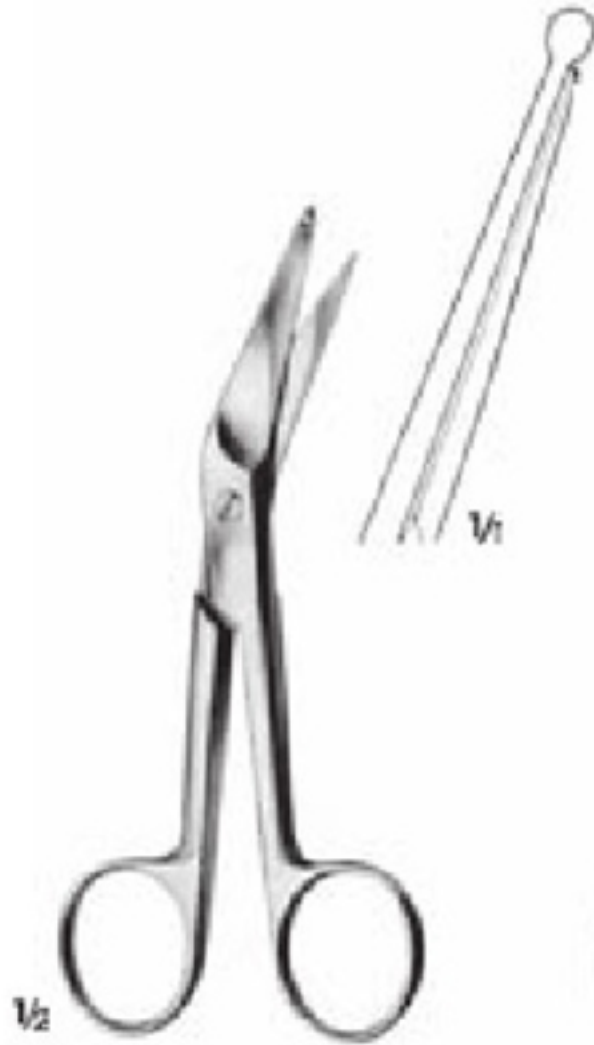

KNOWLES
 EM-03-338
 14 cm

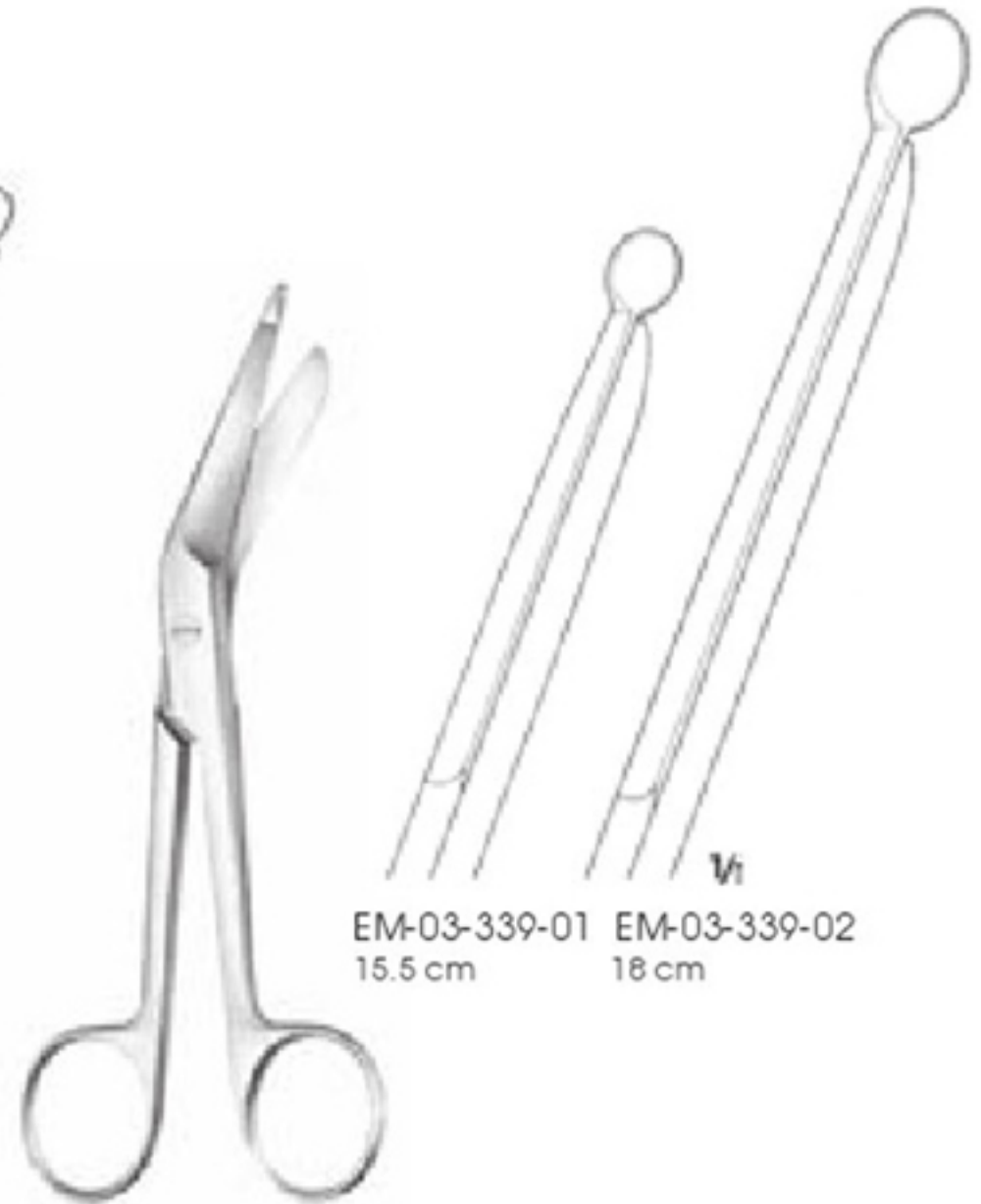

EM-03-339-01 EM-03-339-02
 15.5 cm 18 cm

KNOWLES
 EM-03-339-01 - 339-02



LISTER
 EM-03-340-01 - 340-01

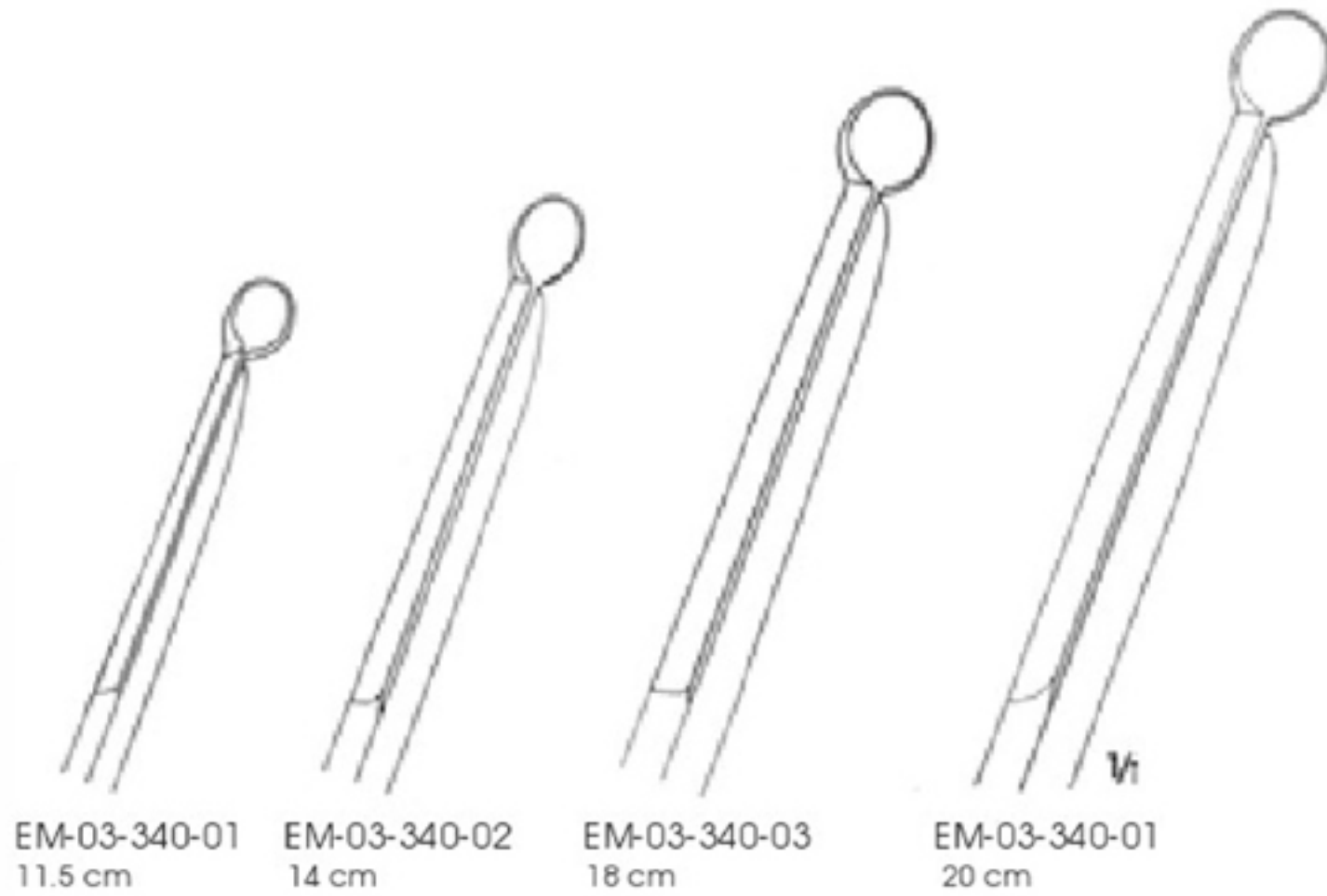

EM-03-340-01 EM-03-340-02 EM-03-340-03 EM-03-340-01
 11.5 cm 14 cm 18 cm 20 cm



LISTER
 EM-03-341
 Bandage scissor
 16 cm



EM-03-342
 For small plaster dressing
 One jaw serrated
 16 cm



EM-03-343-01 20 cm
 EM-03-343-02 23 cm
 ESMARCH
 EM-03-343-01 - 343-02
 Plaster scissors
 One jaw serrated



BERGMANN
 EM-03-344
 Plaster scissors
 One jaw serrated
 23 cm



SEUTIN
 EM-03-345
 Bandage scissors
 One jaw serrated
 23 cm

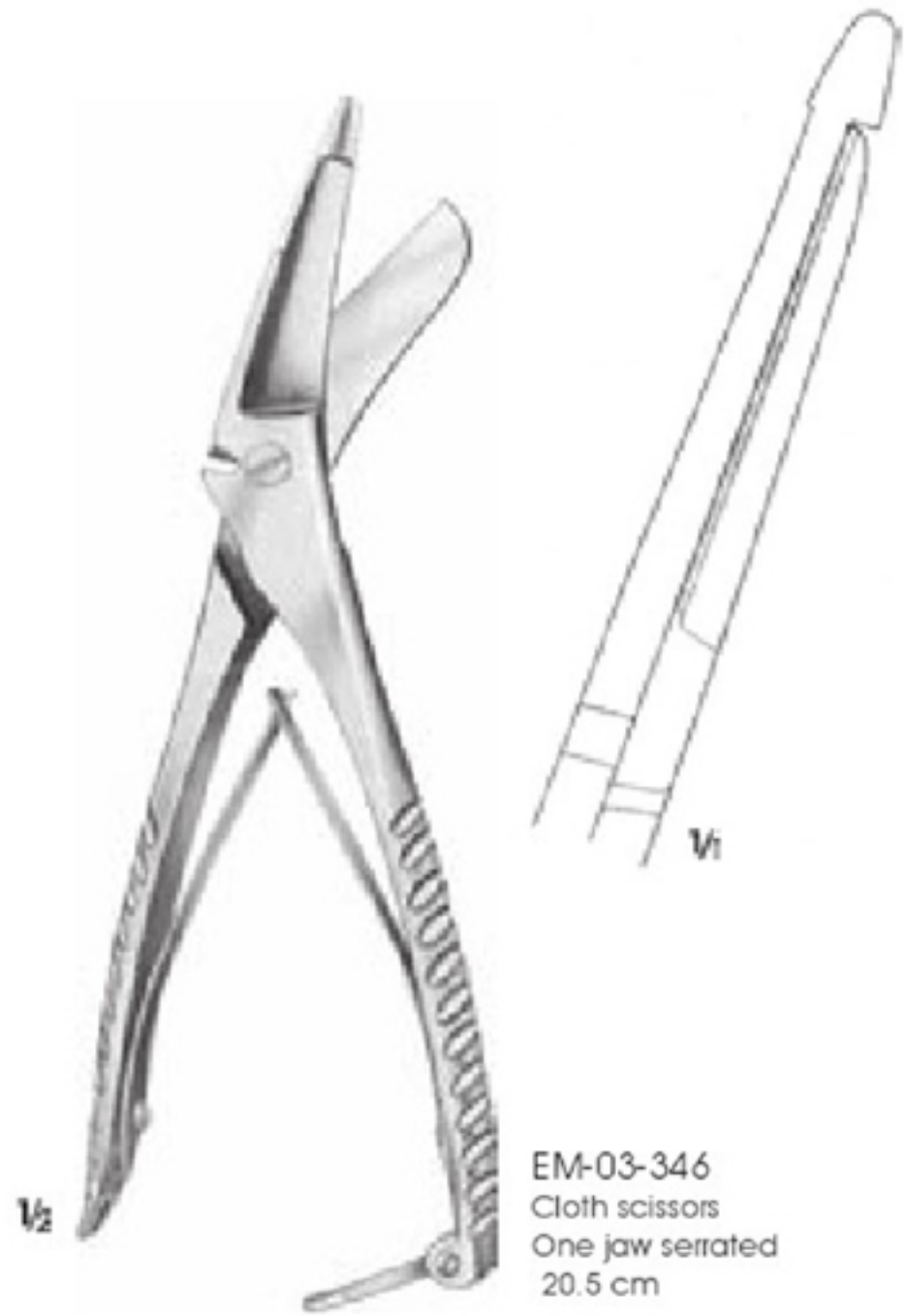

EM-03-346
 Cloth scissors
 One jaw serrated
 20.5 cm



BRUNS
 EM-03-347
 Plaster scissors
 23.5 cm

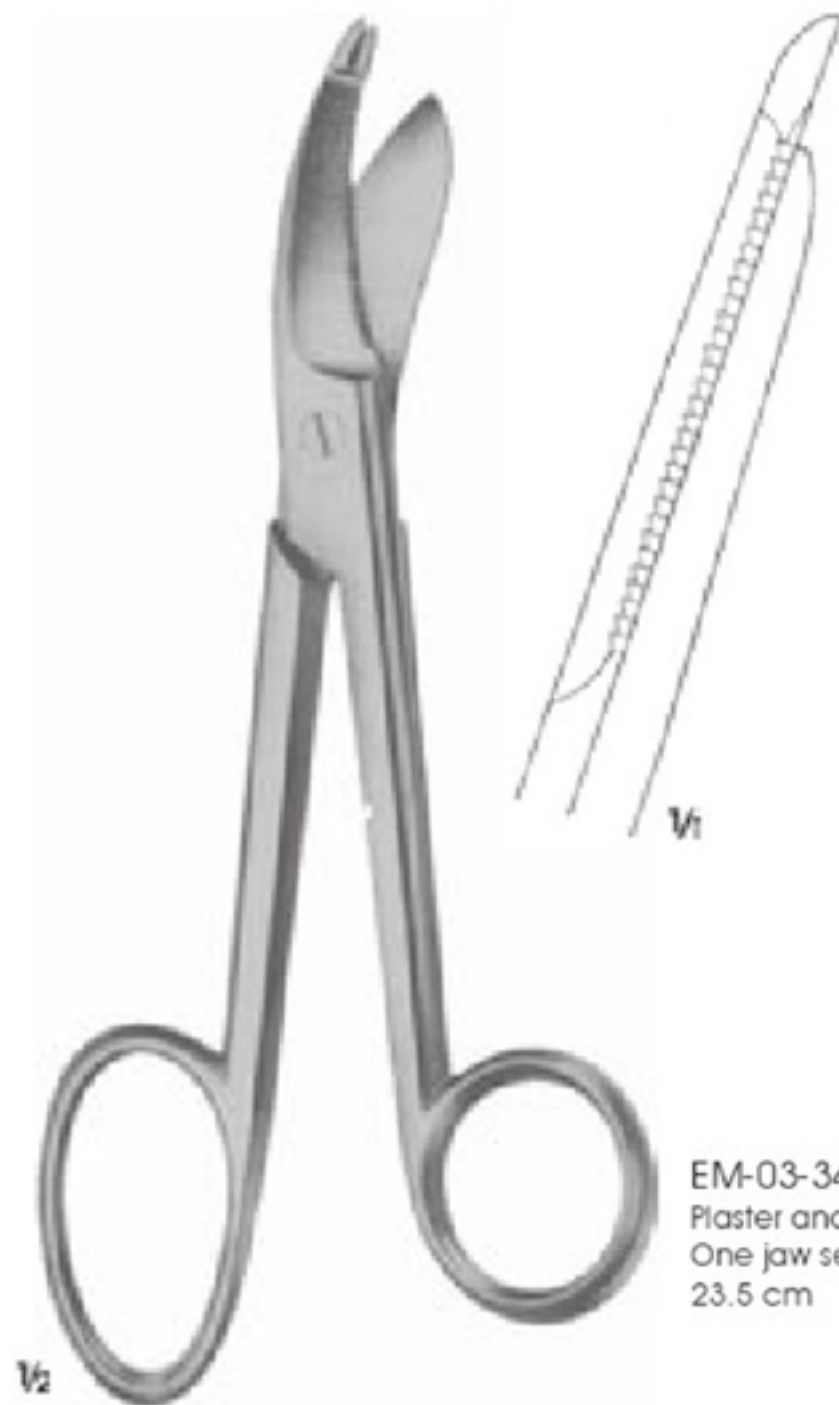

EM-03-348
 Plaster and cloth scissors
 One jaw serrated
 23.5 cm

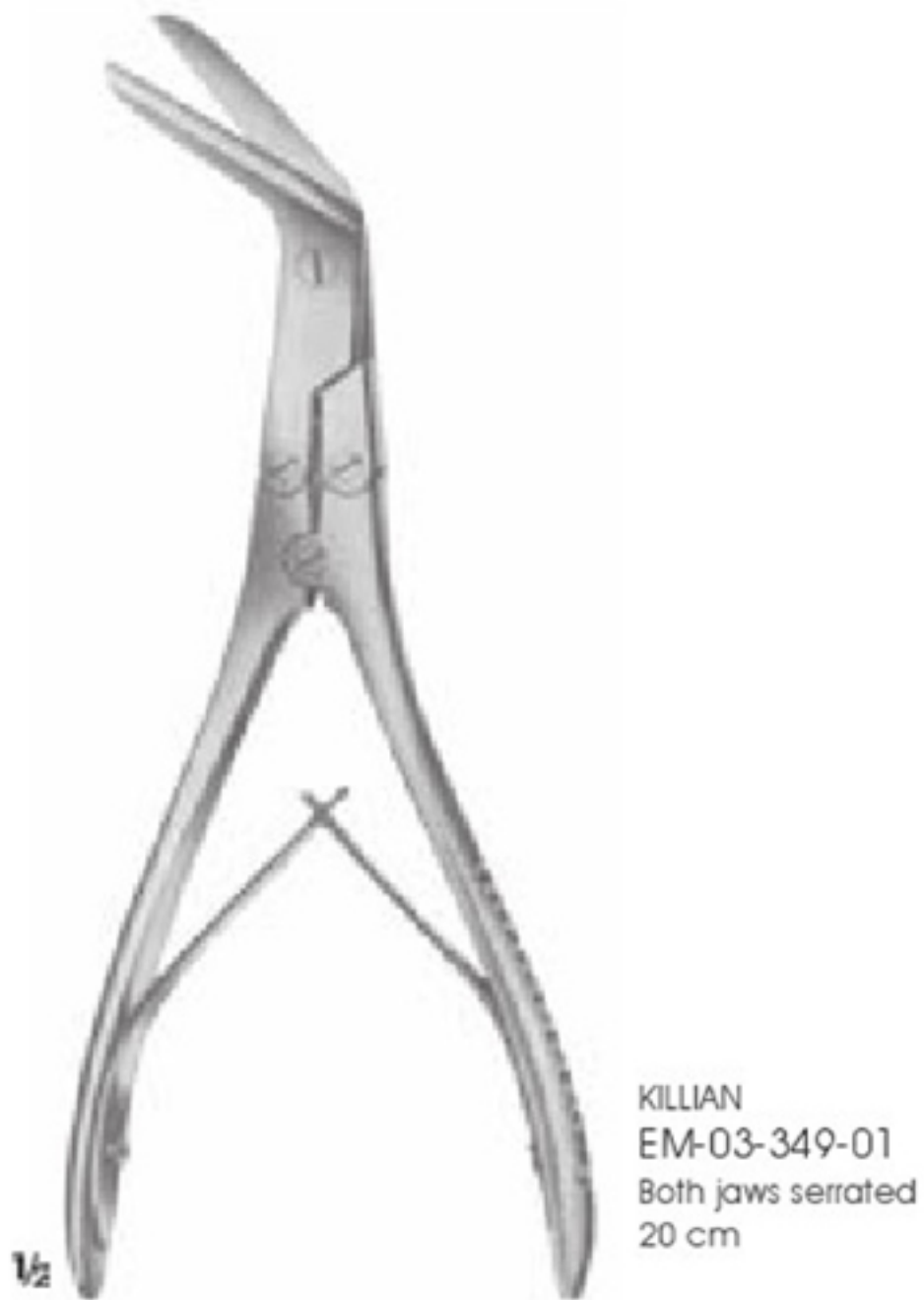
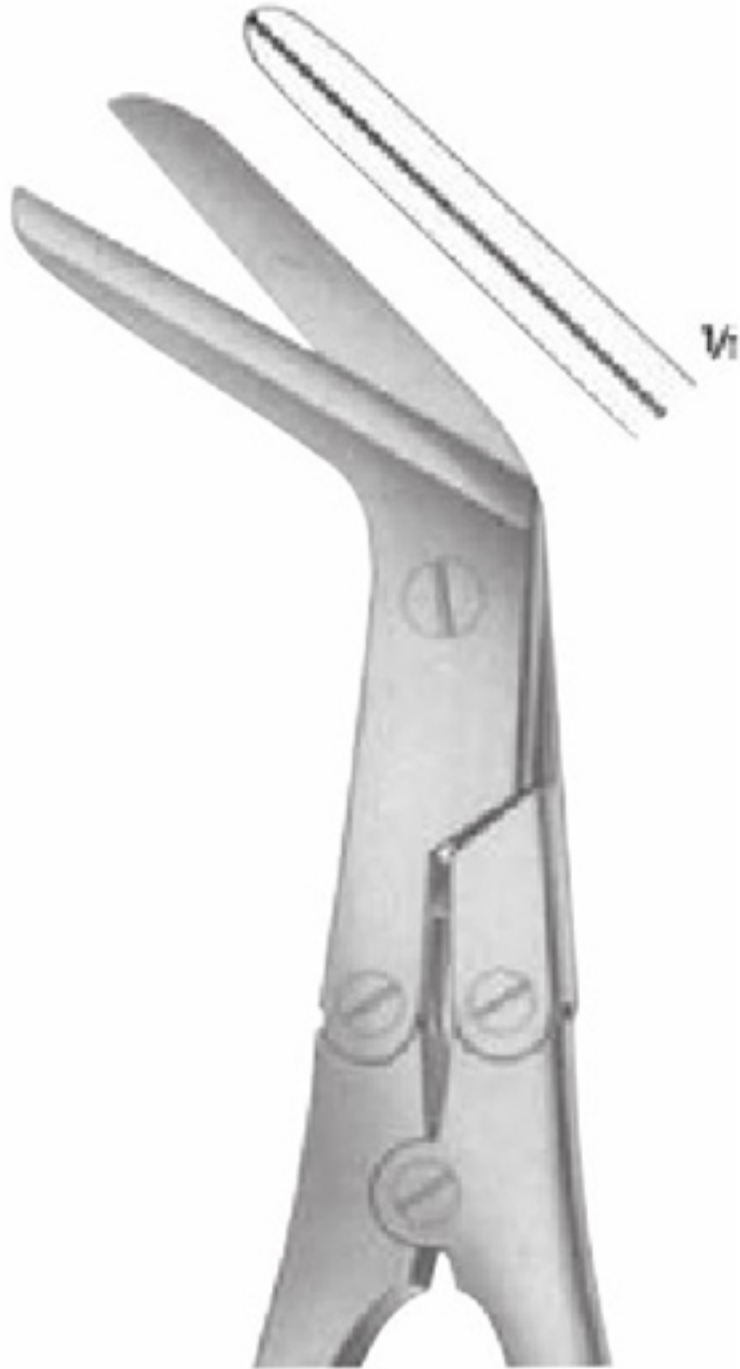

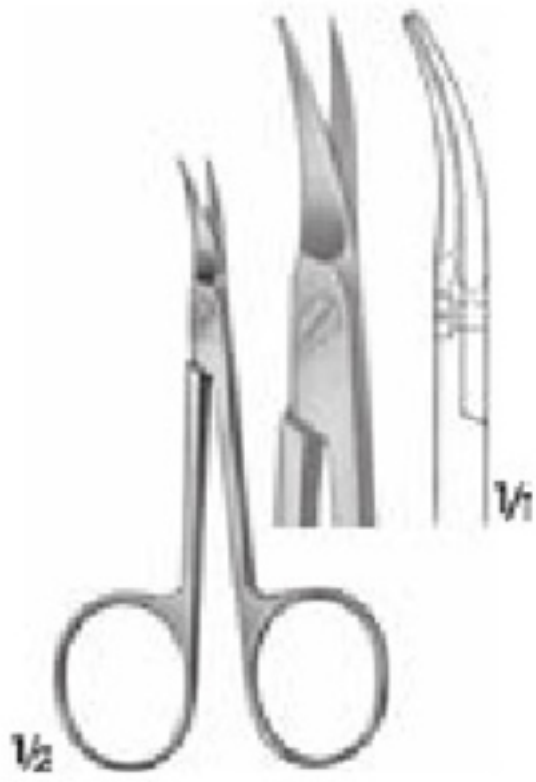

EM-03-350-01
Nail scissors
9 cm



EM-03-350-02
Nail Scissors, especially delicate
pattern
9 cm



EM-03-351
Baby nail scissors
8.5 cm



SPENCER
EM-03-352-01 - 352-02
Ligature scissors

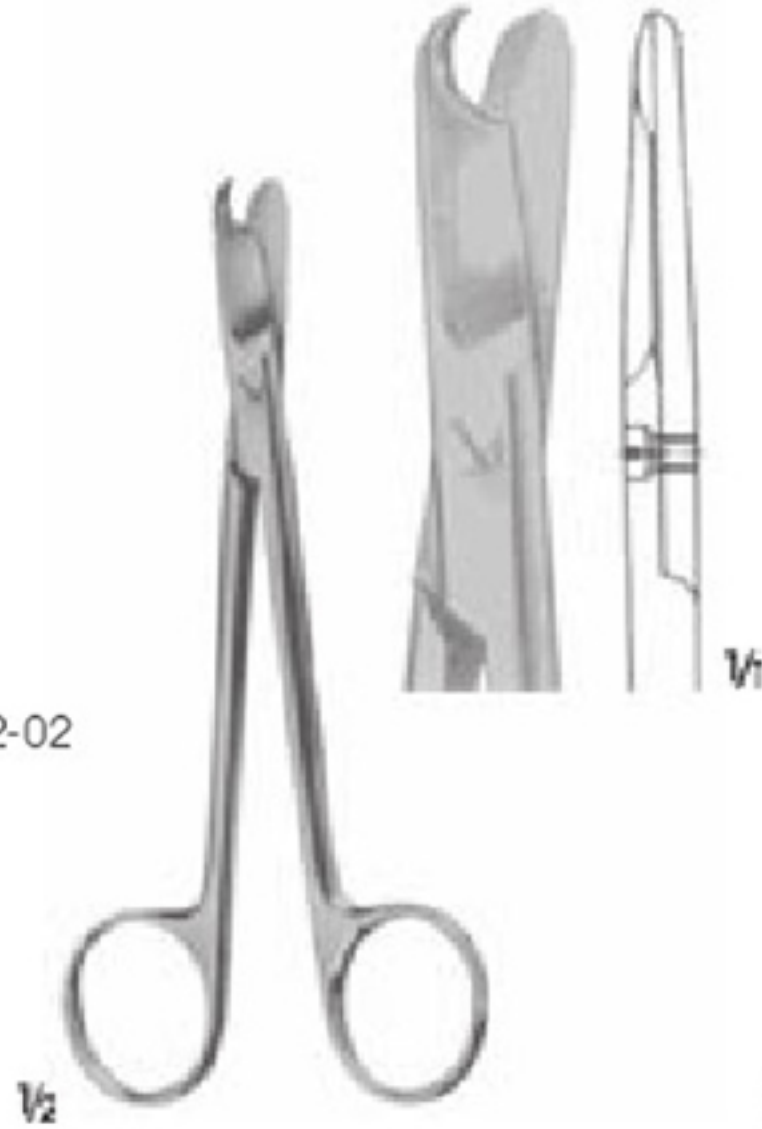

LITAUER
EM-03-353
Ligature scissors
13.5 cm

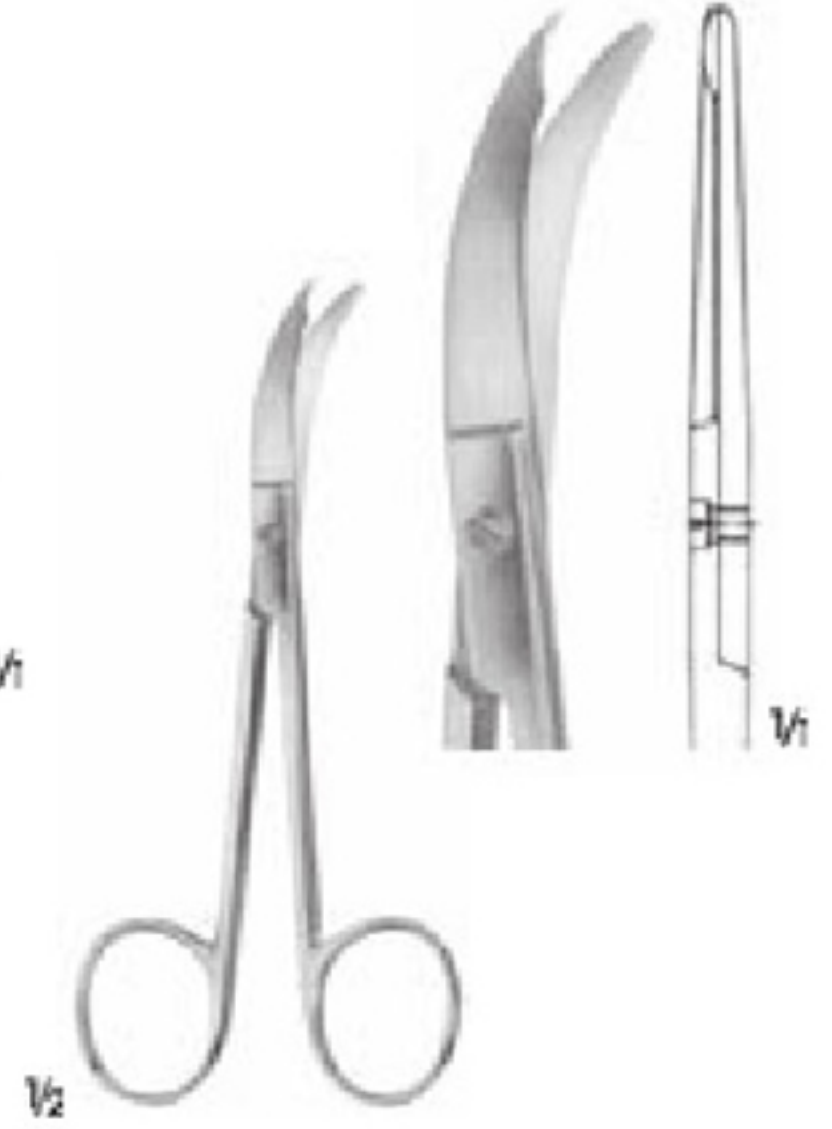

NORTHBENT
EM-03-354
Ligature scissors
12 cm



1/2

BEEBE
EM-03-355-01 - 355-02
11 cm



EM-03-355-01 EM-03-355-02



EM-03-356
Broad blades

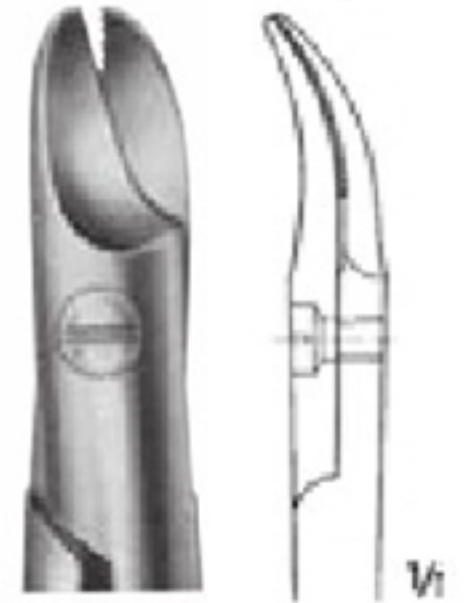

EM-03-357
One jaw serrated

1/1

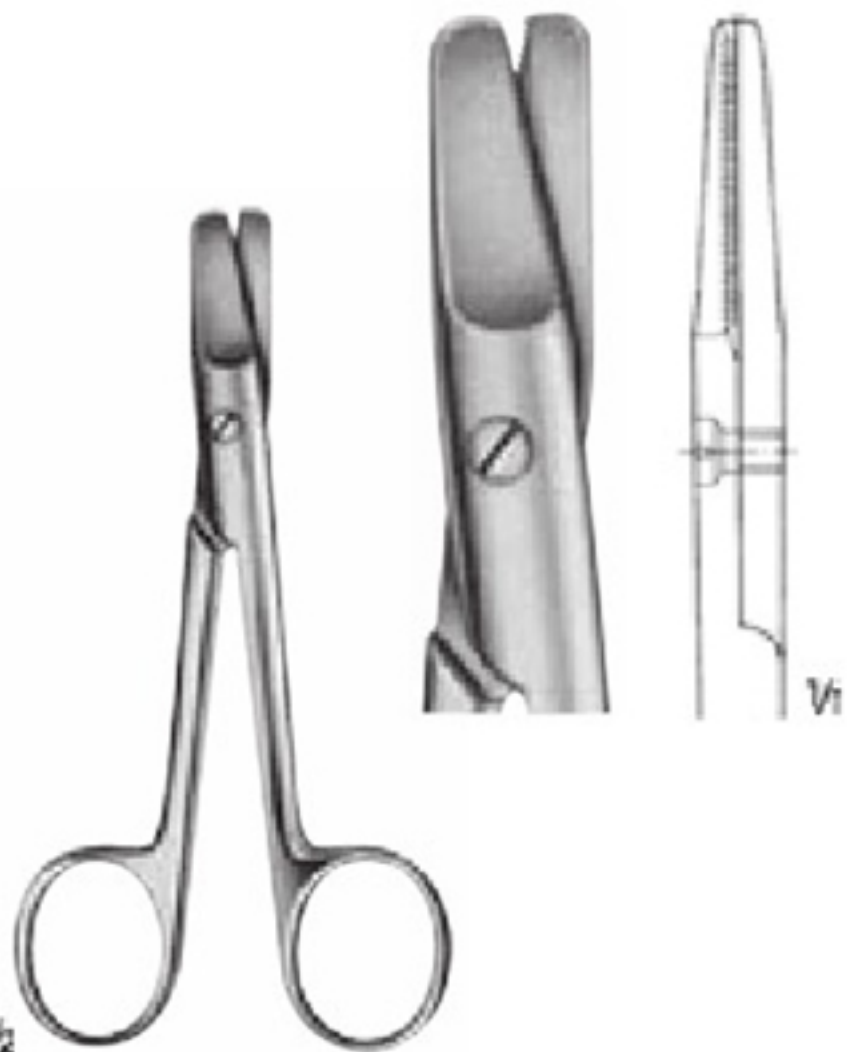

1/2

HARVEY
EM-03-358
Both jaws serrated
12.5 cm

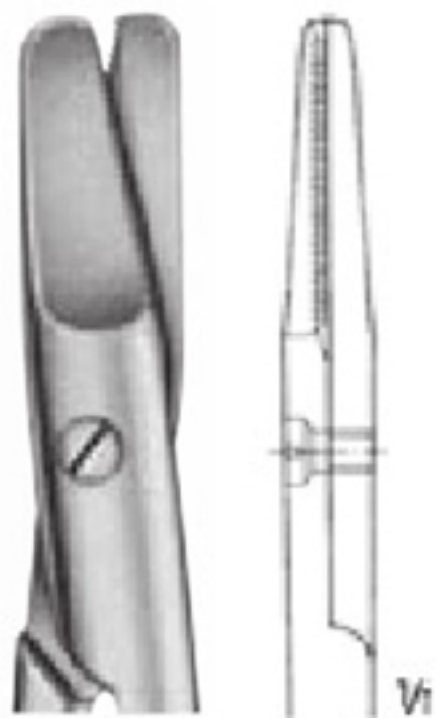

1/1

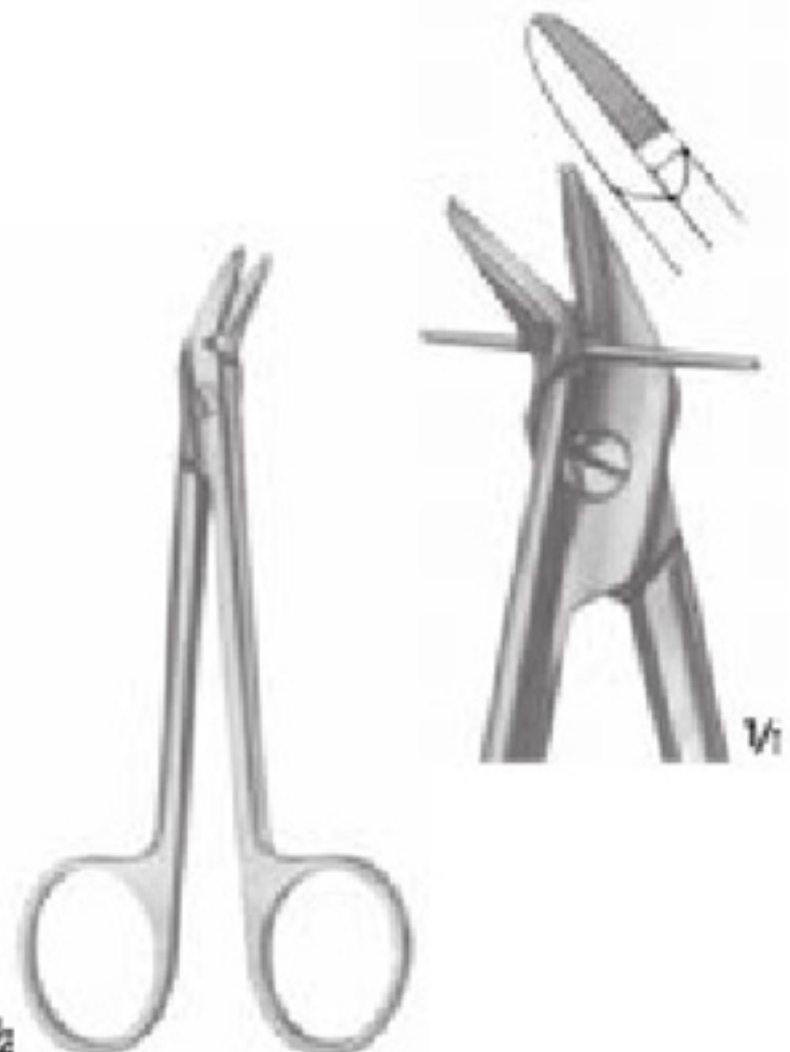

1/2

EM-03-359
One jaws serrated
12 cm



1/1

HARDTIPS scissors with inserted carbide cutting edges

- Excellent Cutting
- Long working

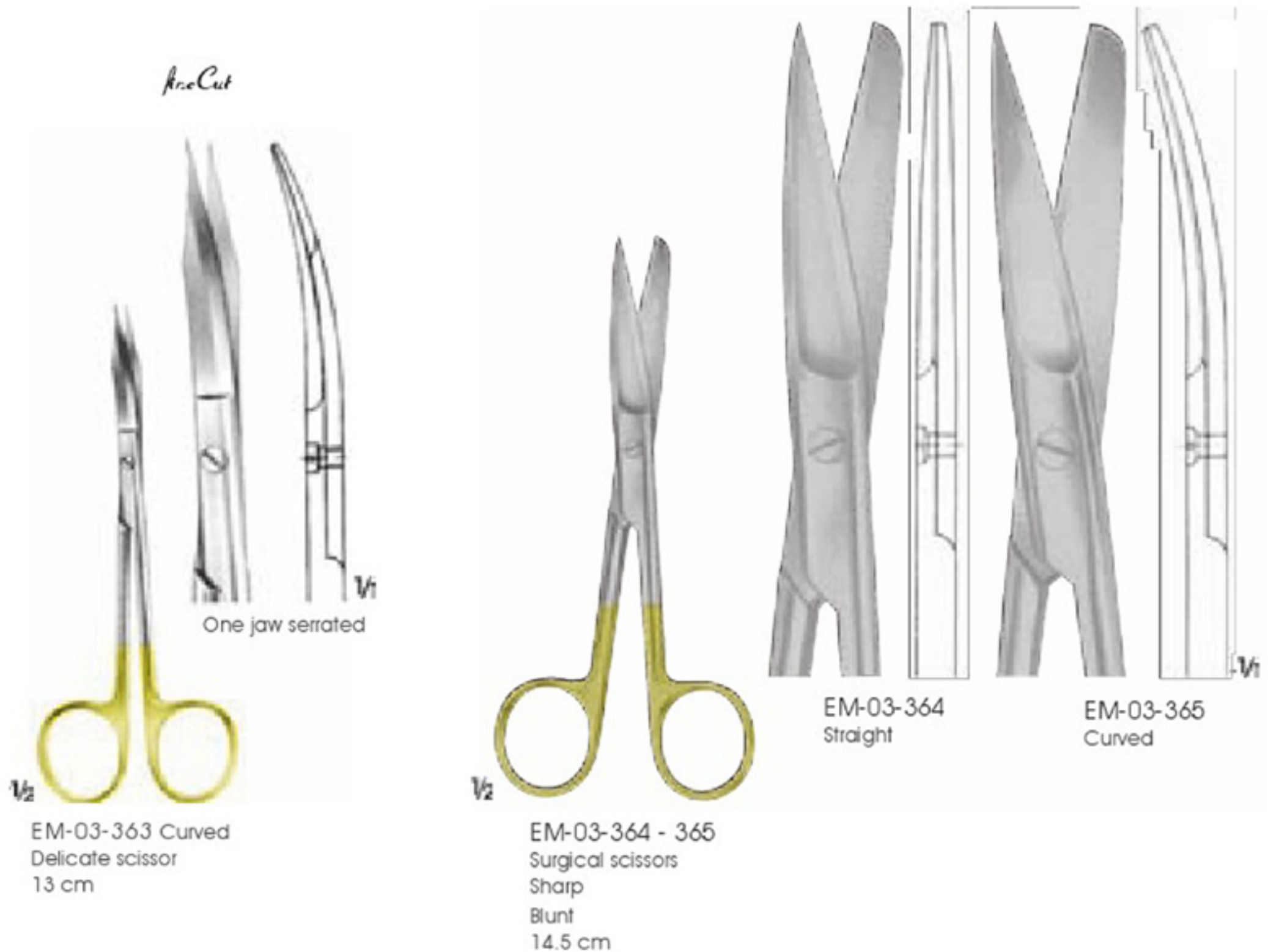
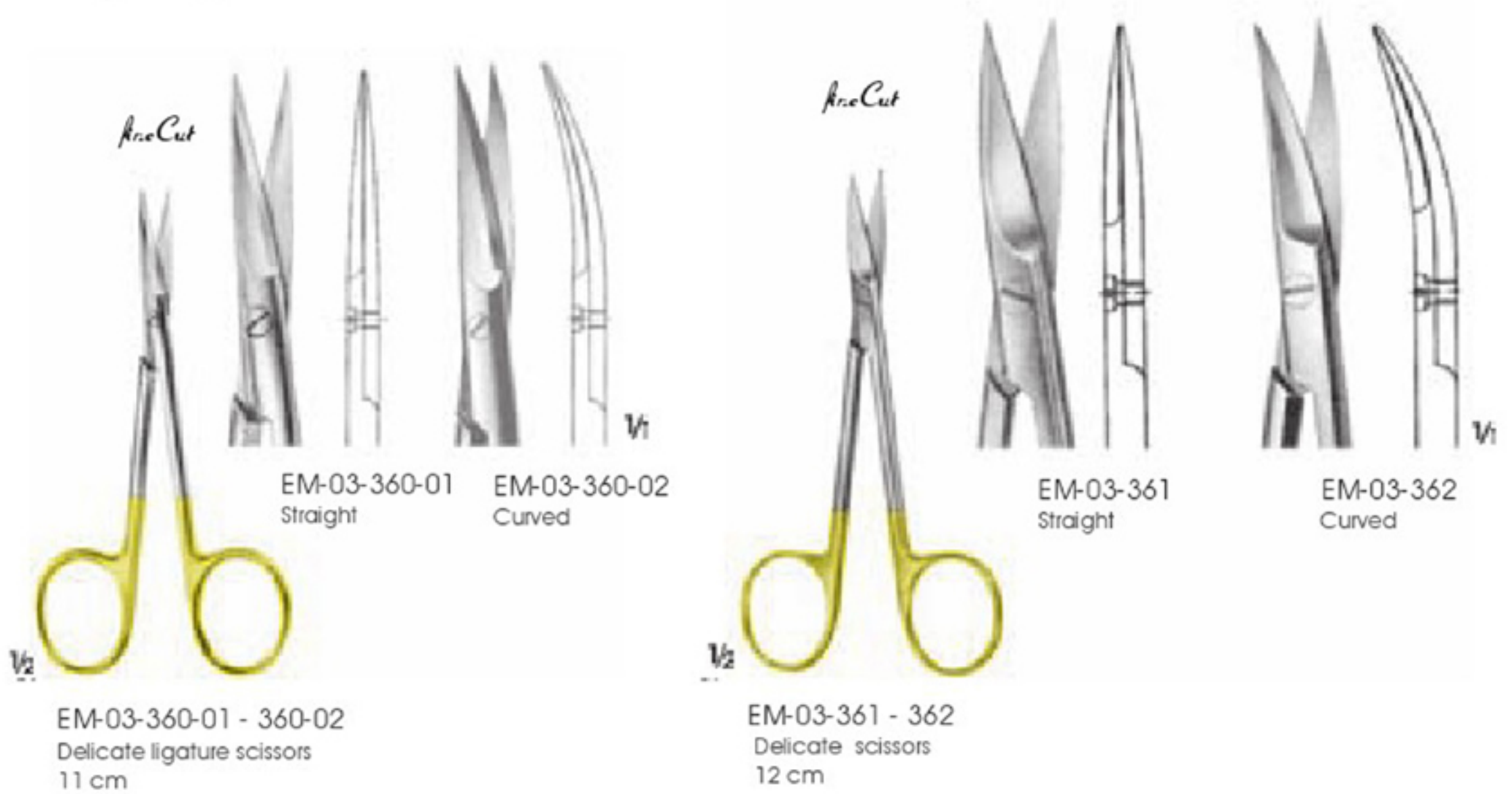

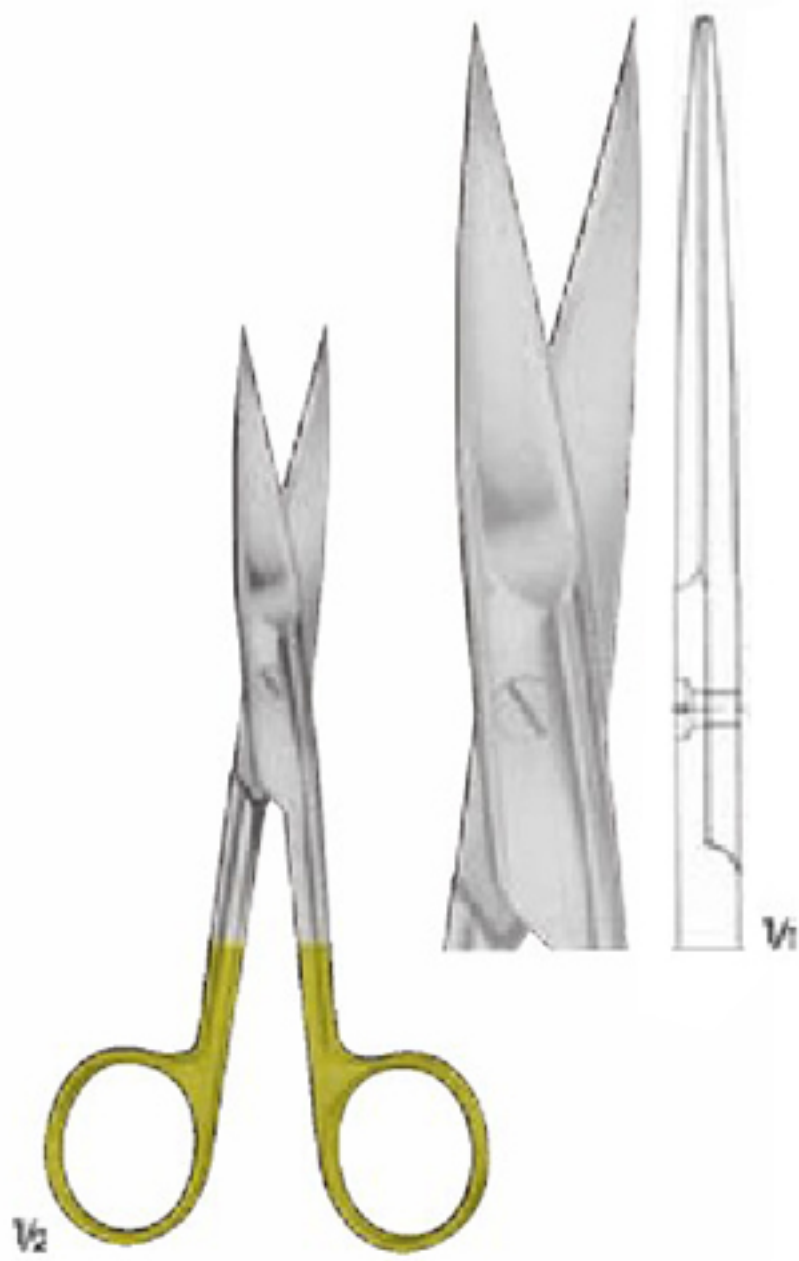

EM-03-366
Surgical scissors
14.5 cm

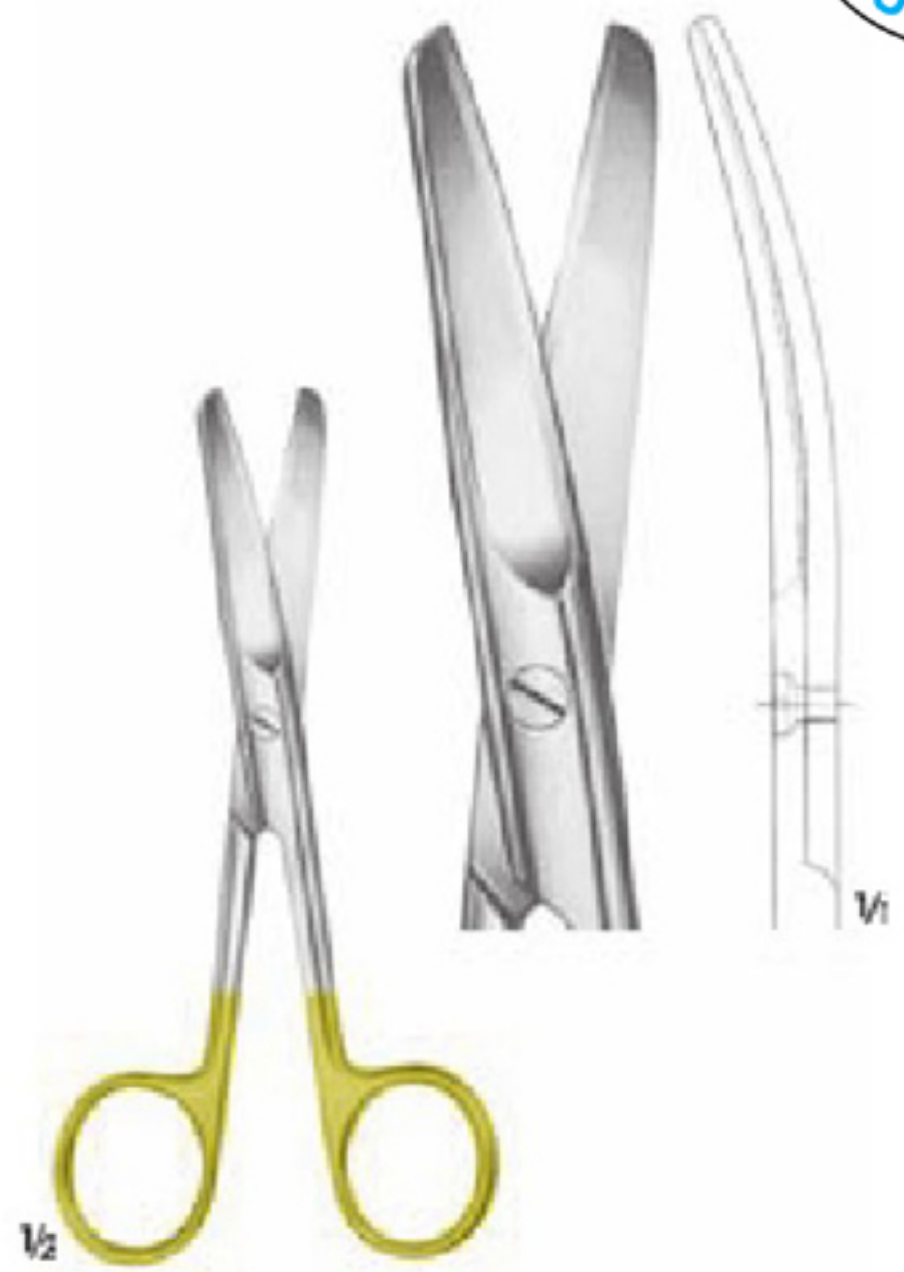

EM-03-367
Surgical scissors
14.5 cm

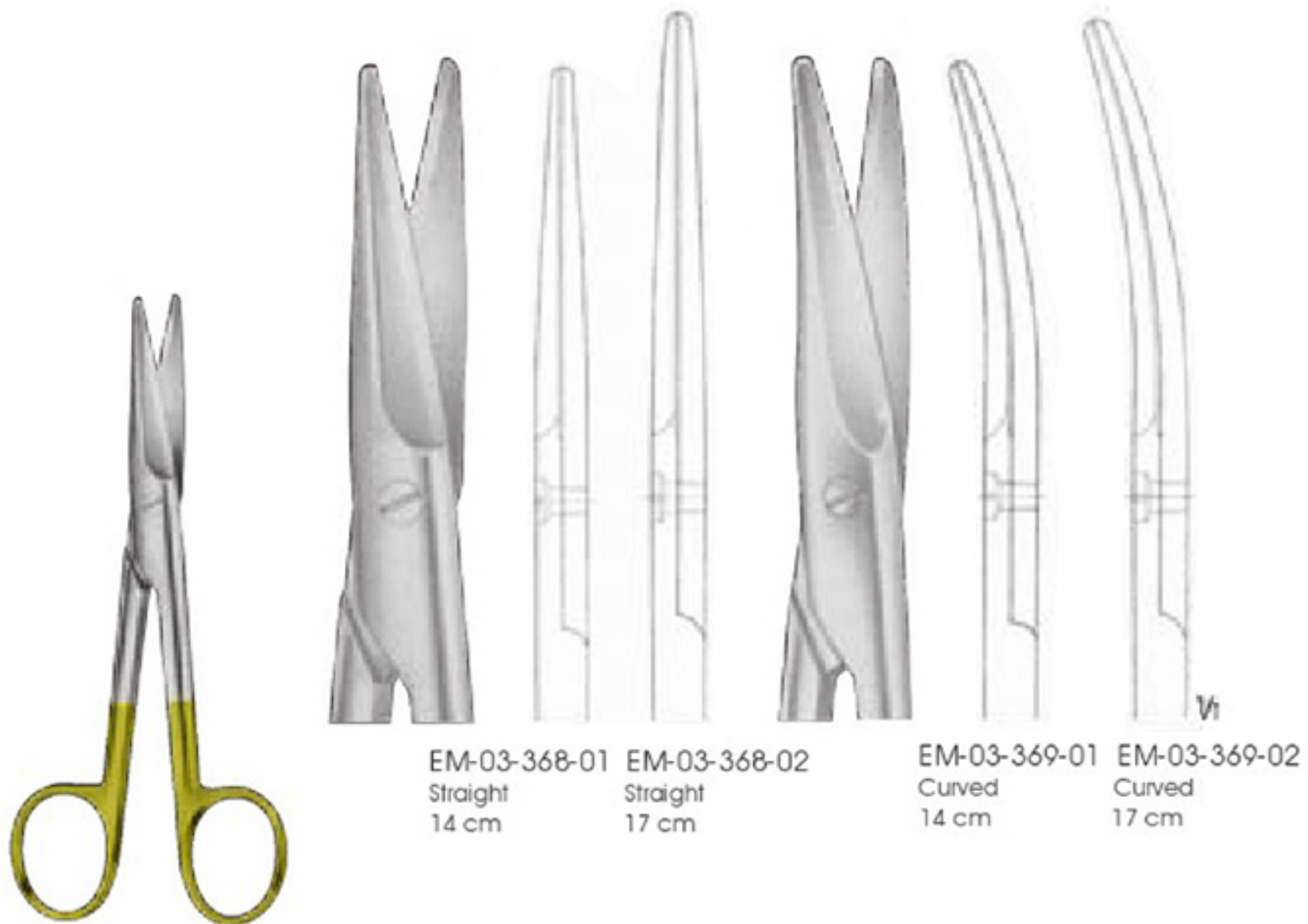

MAYO
EM-03-368-01 - 369-02
Dissecting scissors

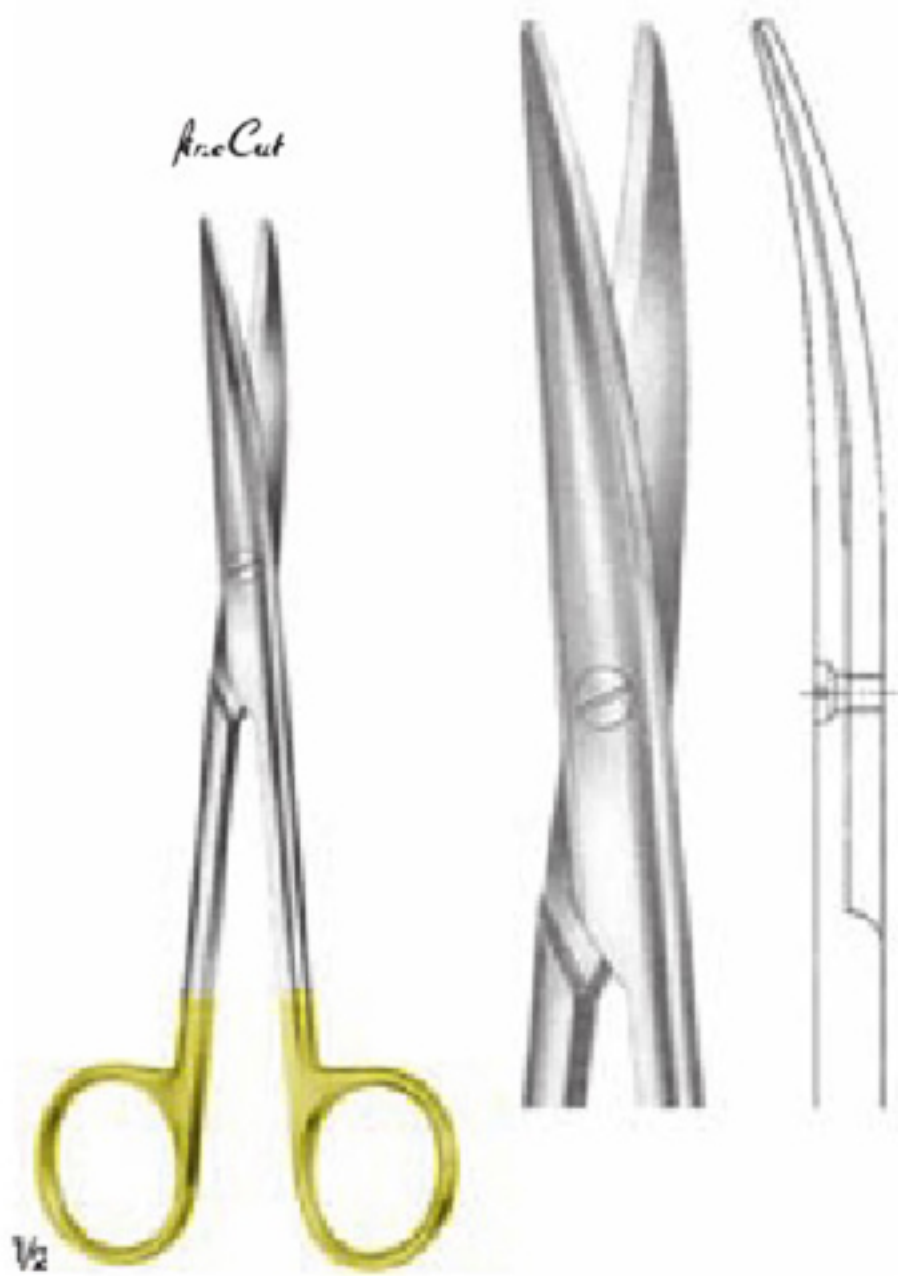

LEXER
EM-03-370
Dar/Narrow
16.5 cm



MAYO-LEXER
EM-03-371
16.5 cm

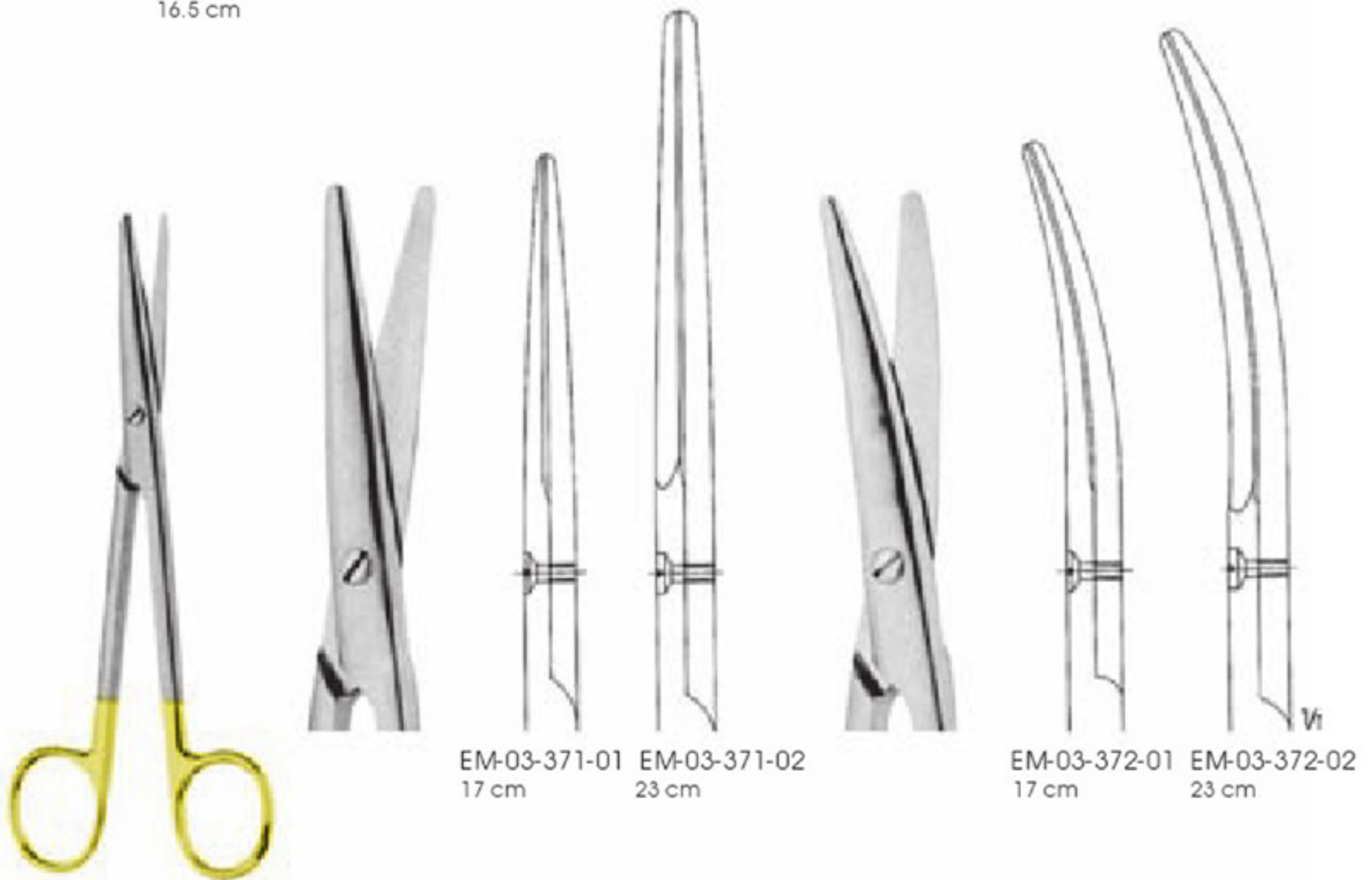

MAYO
EM-03-371-01 - 372-02

EM-03-371-01 17 cm
EM-03-371-02 23 cm

EM-03-372-01 17 cm
EM-03-372-02 23 cm

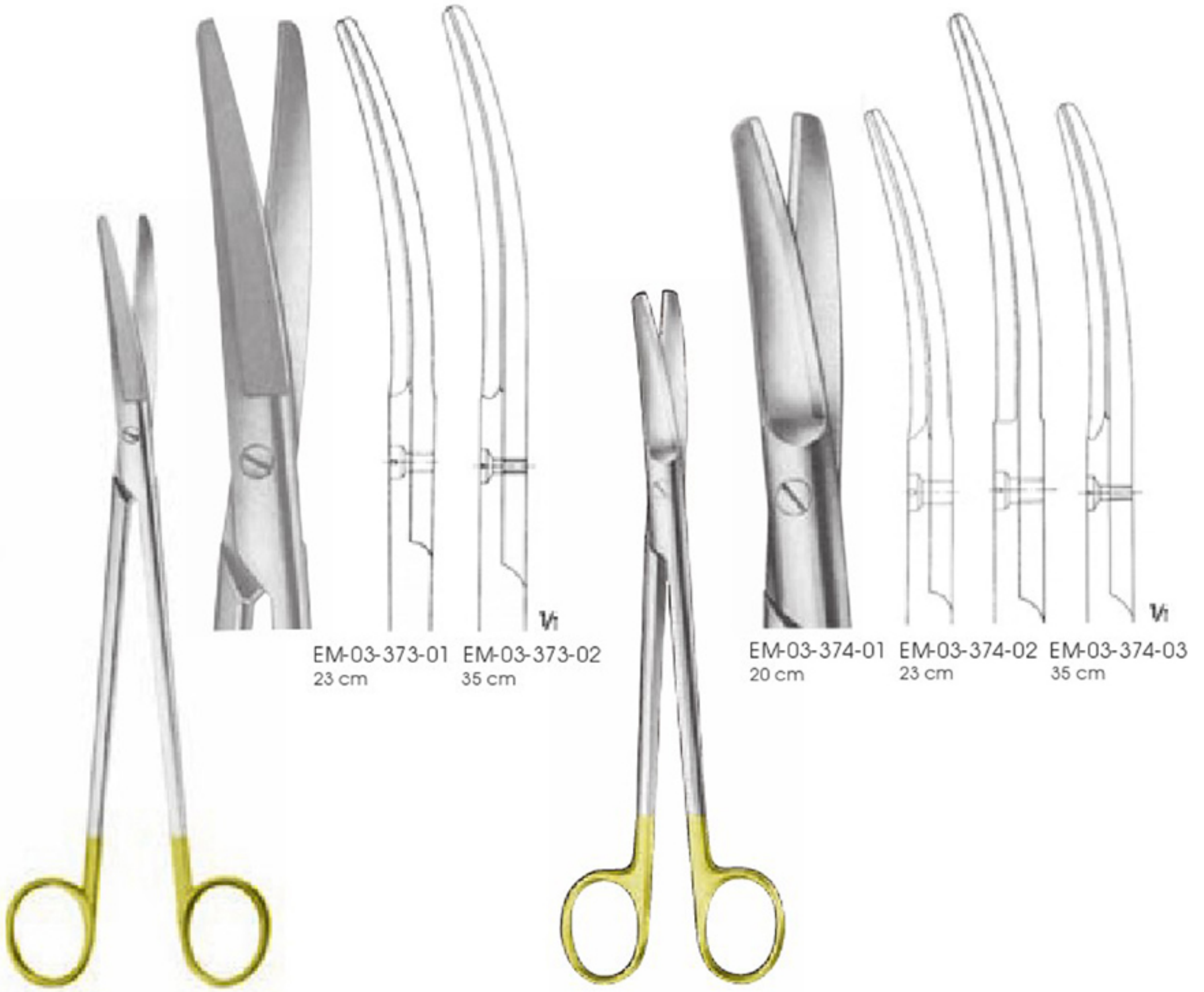

WERTHEIM
EM-03-373-01 - 373-02
Dissecting scissors

SIMS
EM-03-374-01 - 374-03
Uterine Scissors

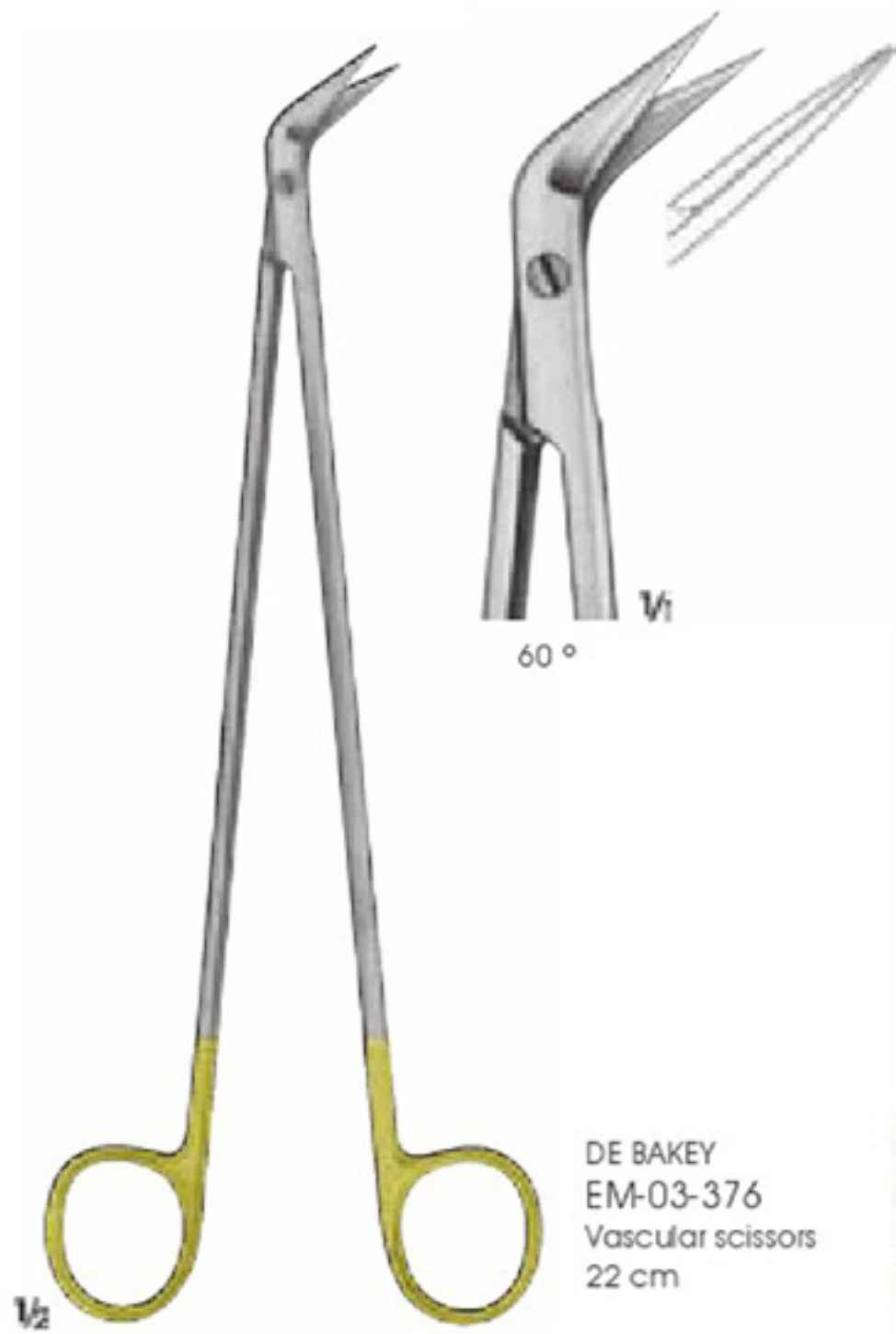
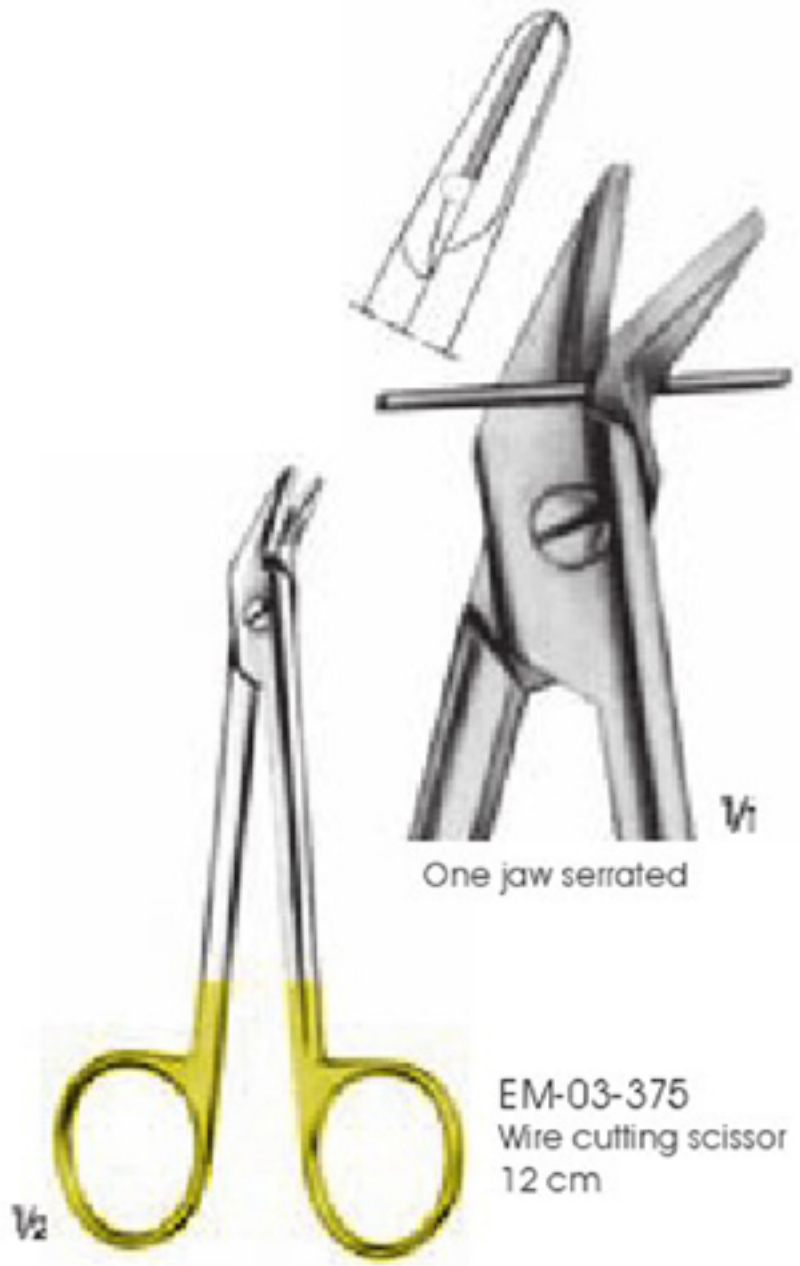





NELSON-METZENBAUM
EM-03-385-01 - 385-03



EM-03-385-01
26 cm

EM-03-385-02
28 cm

EM-03-385-03
28.5 cm

$\frac{1}{2}$



NELSON-METZENBAUM (MC INDOE)
EM-03-386-01 - 387-02



EM-03-386-01
23 cm

EM-03-387-01
23 cm

EM-03-387-02
30 cm

$\frac{1}{2}$

$\frac{1}{2}$



METZENBAUM
EM-03-388
23 cm



Broad blade ends

$\frac{1}{2}$

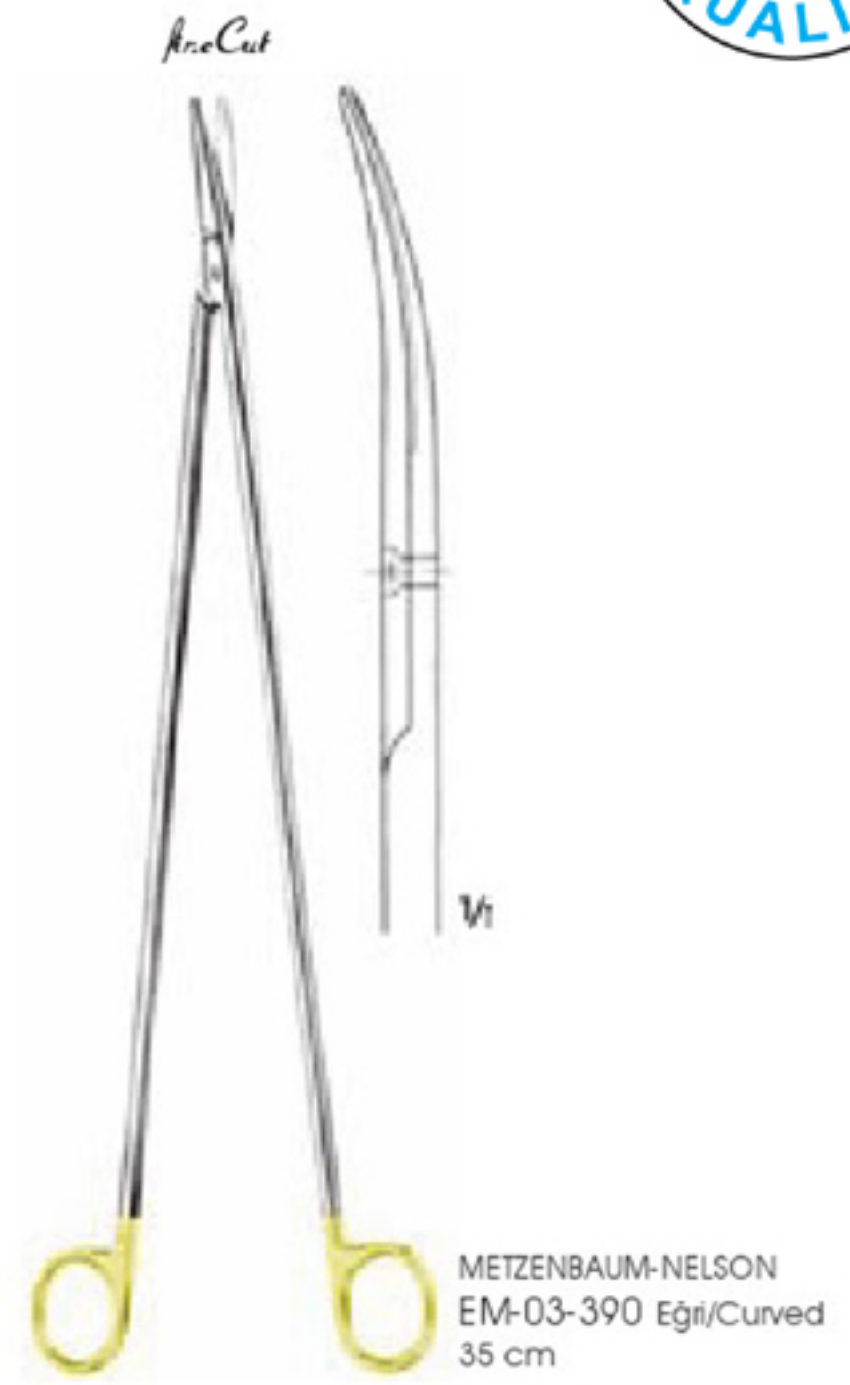
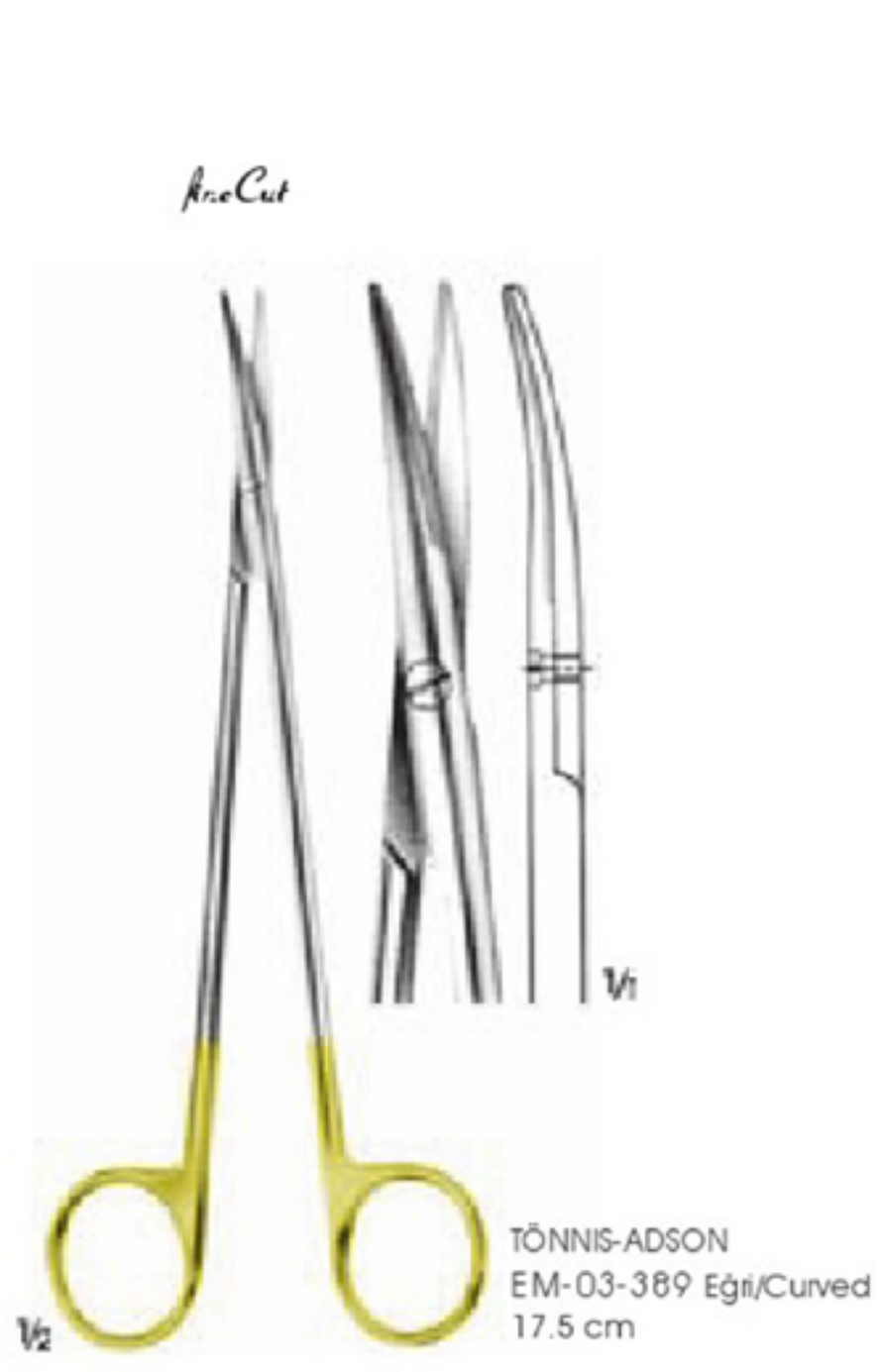



Cutting suture materials;

- Carbide inserts on *GripCut* scissors provide lasting sharpness. (including tip of the blades of the scissors)
- Serrated edges on *GripCut* scissors prevents suture materials from slipping out.

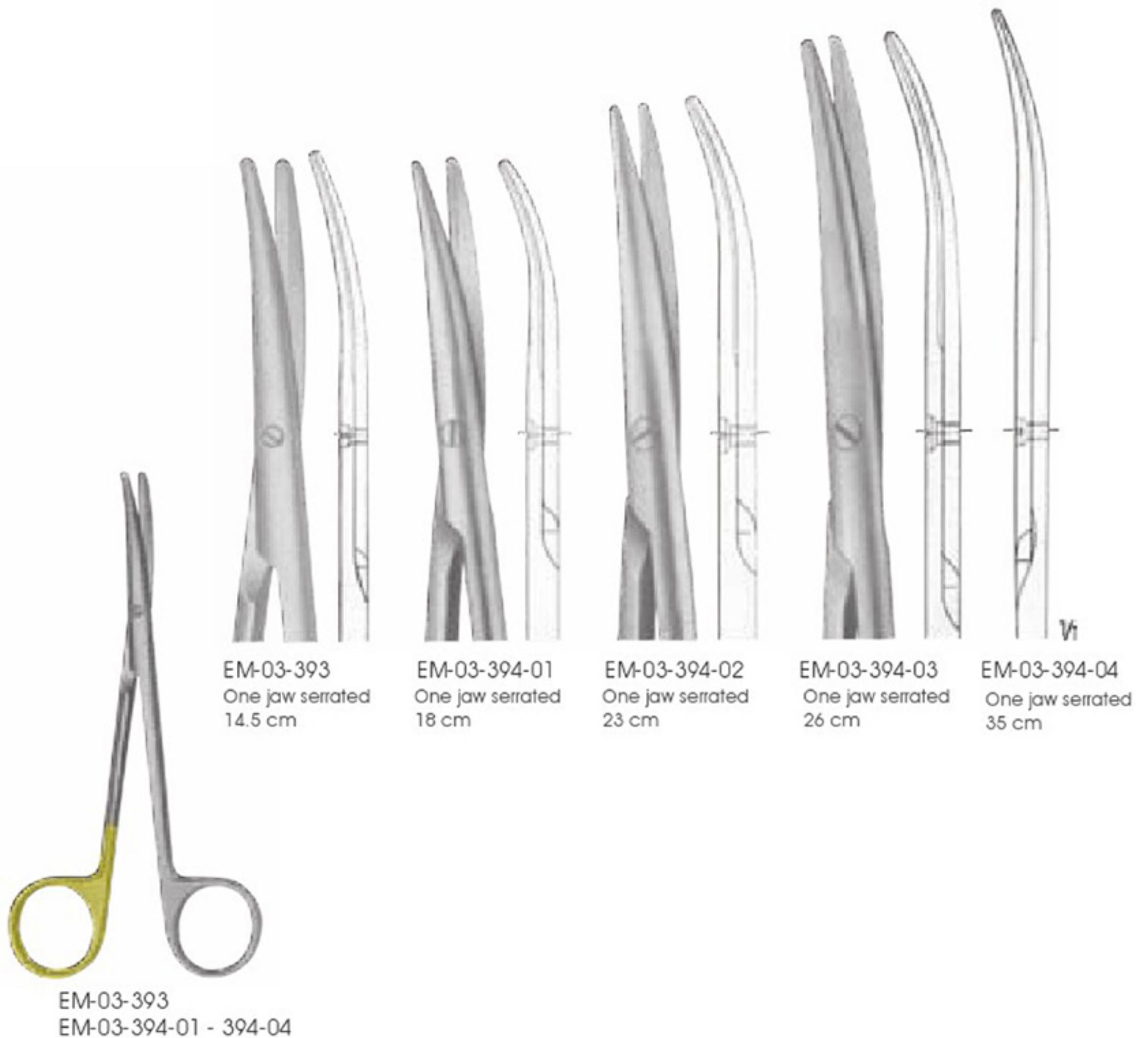

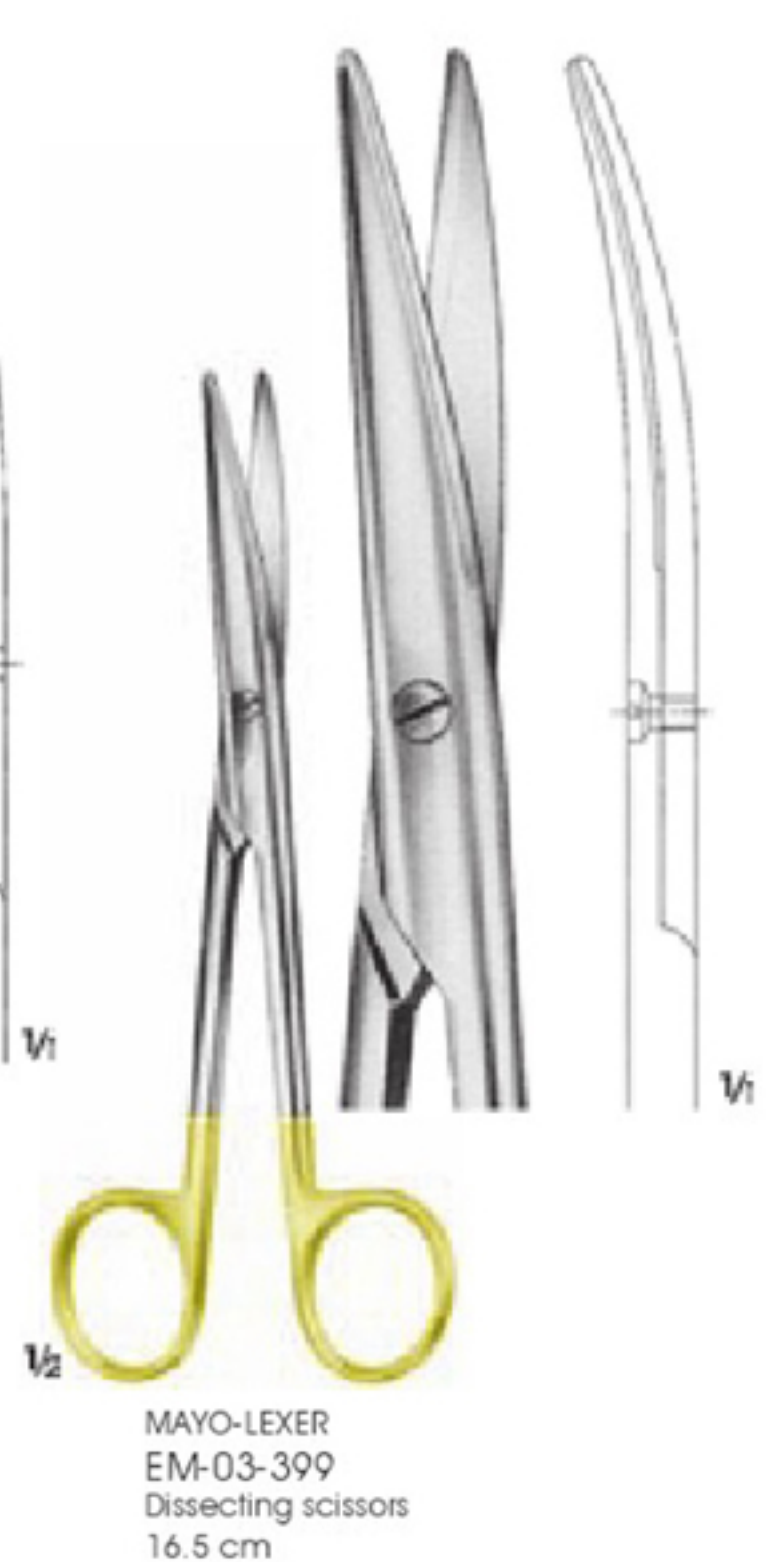
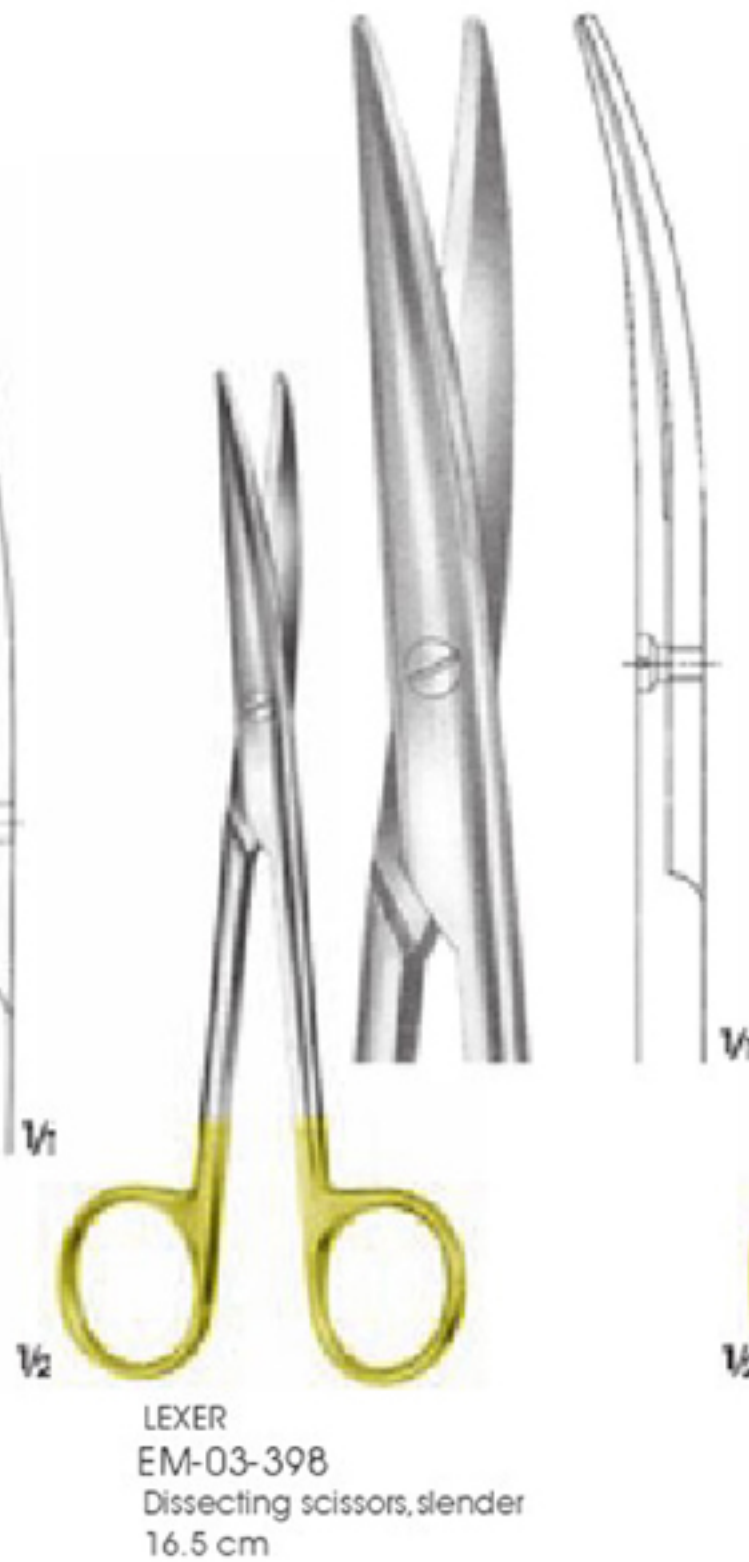
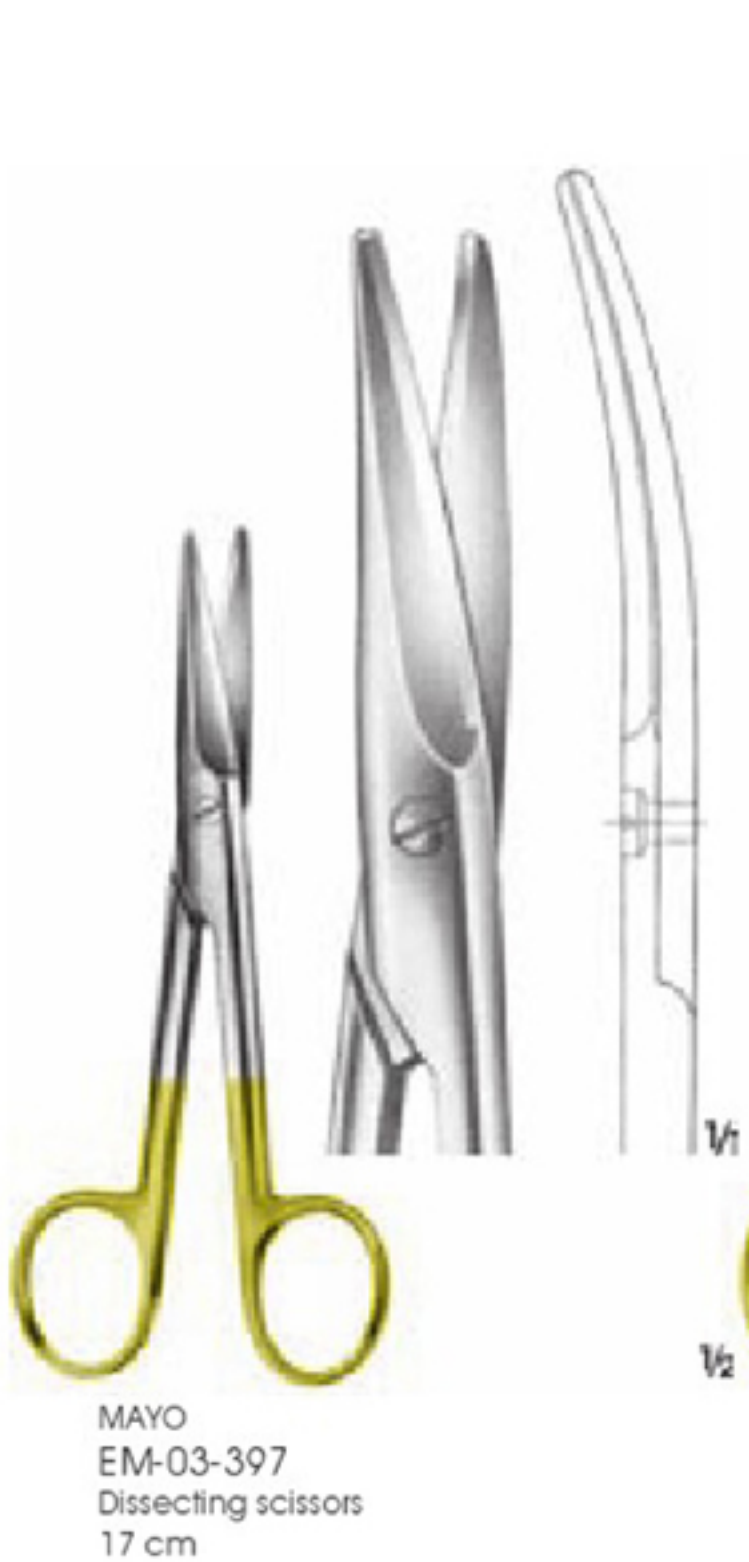
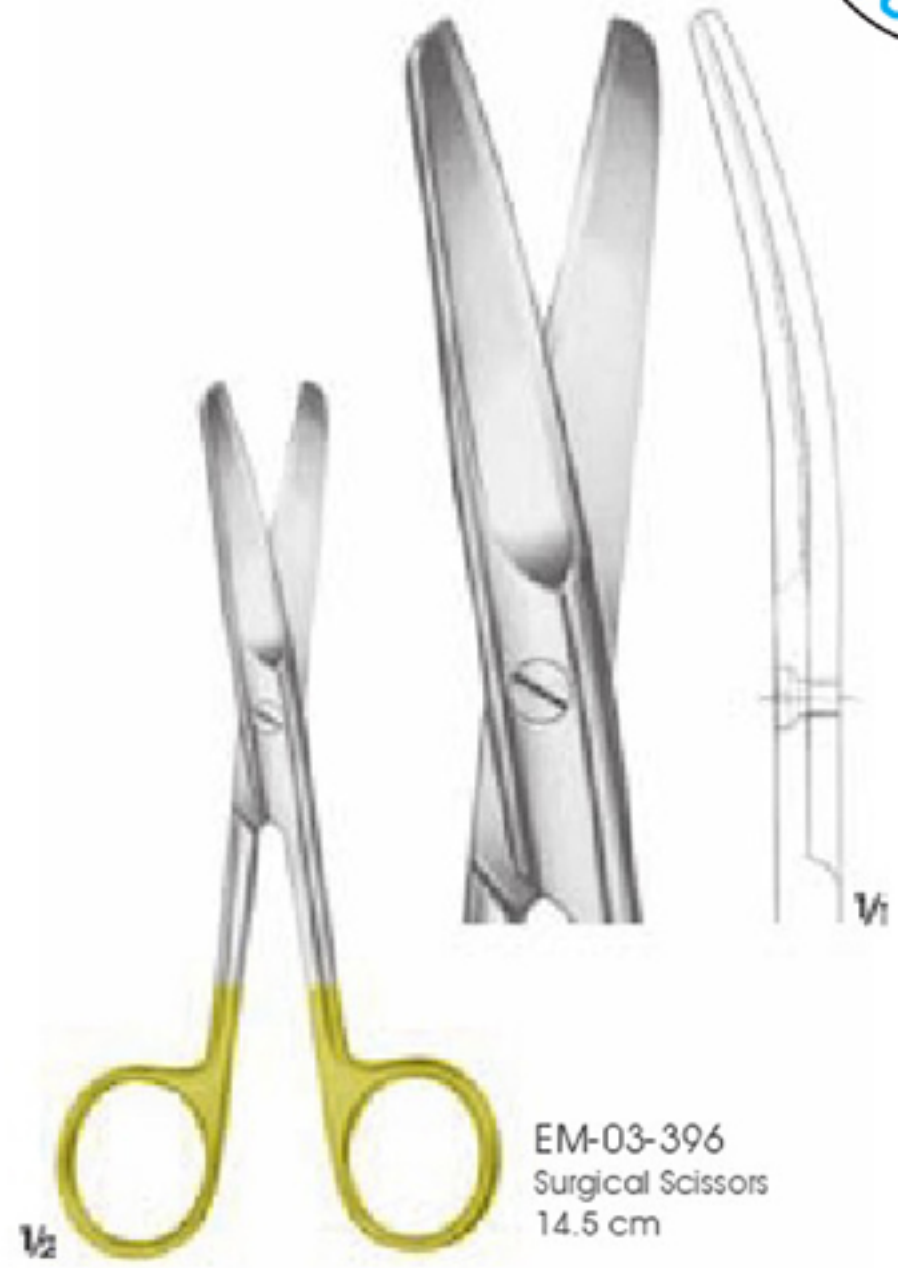

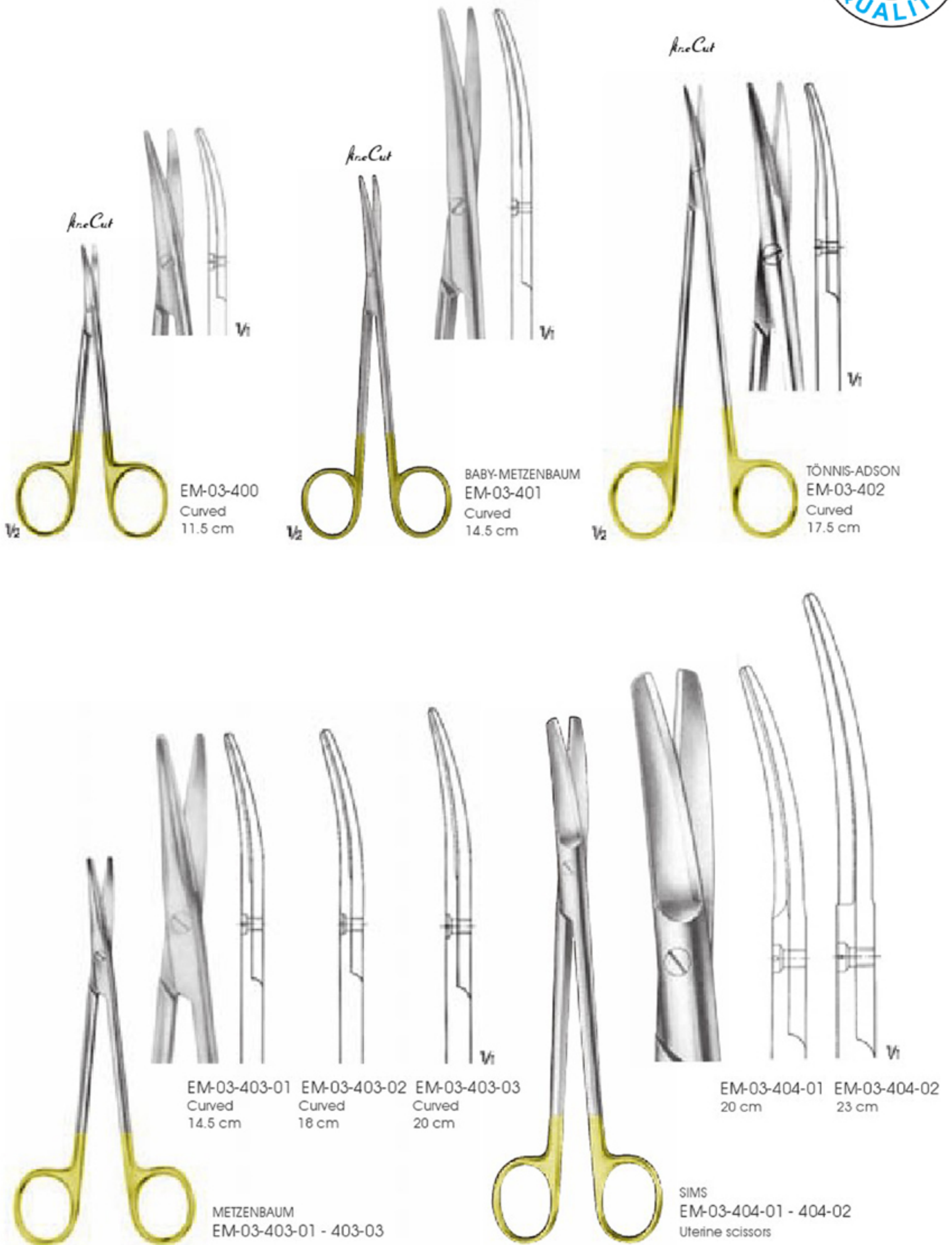

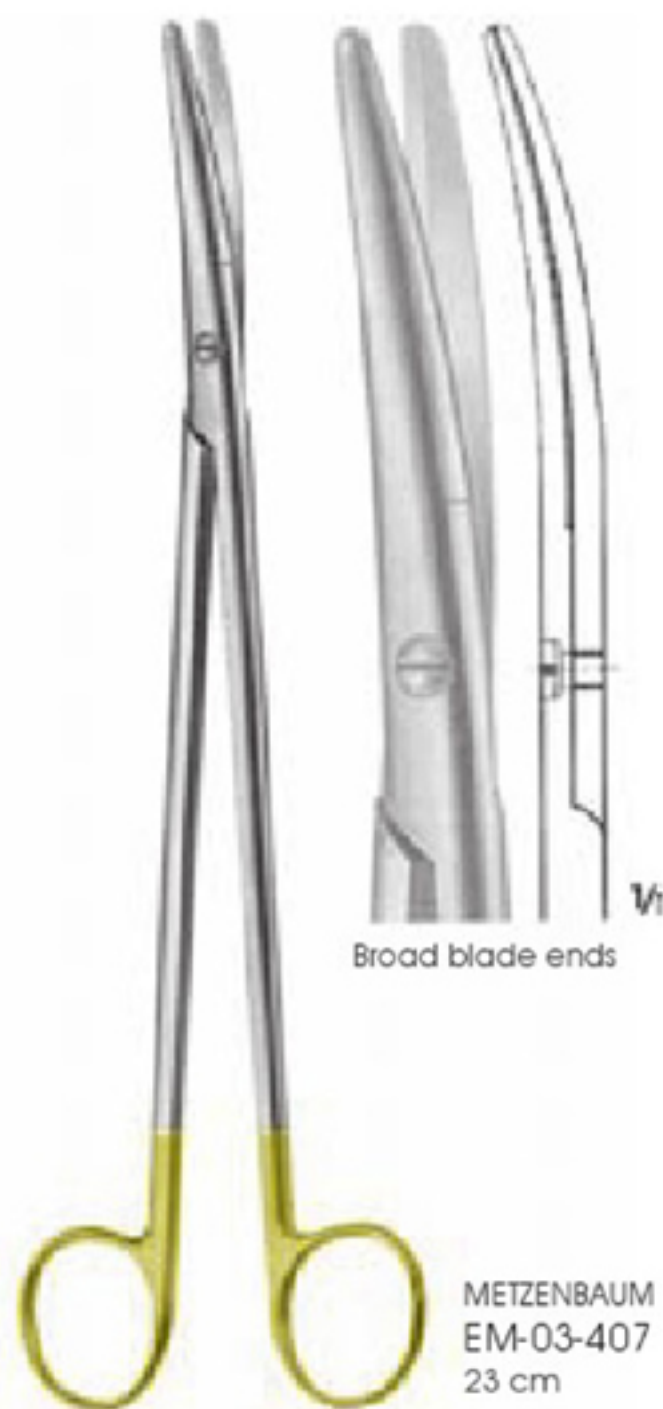
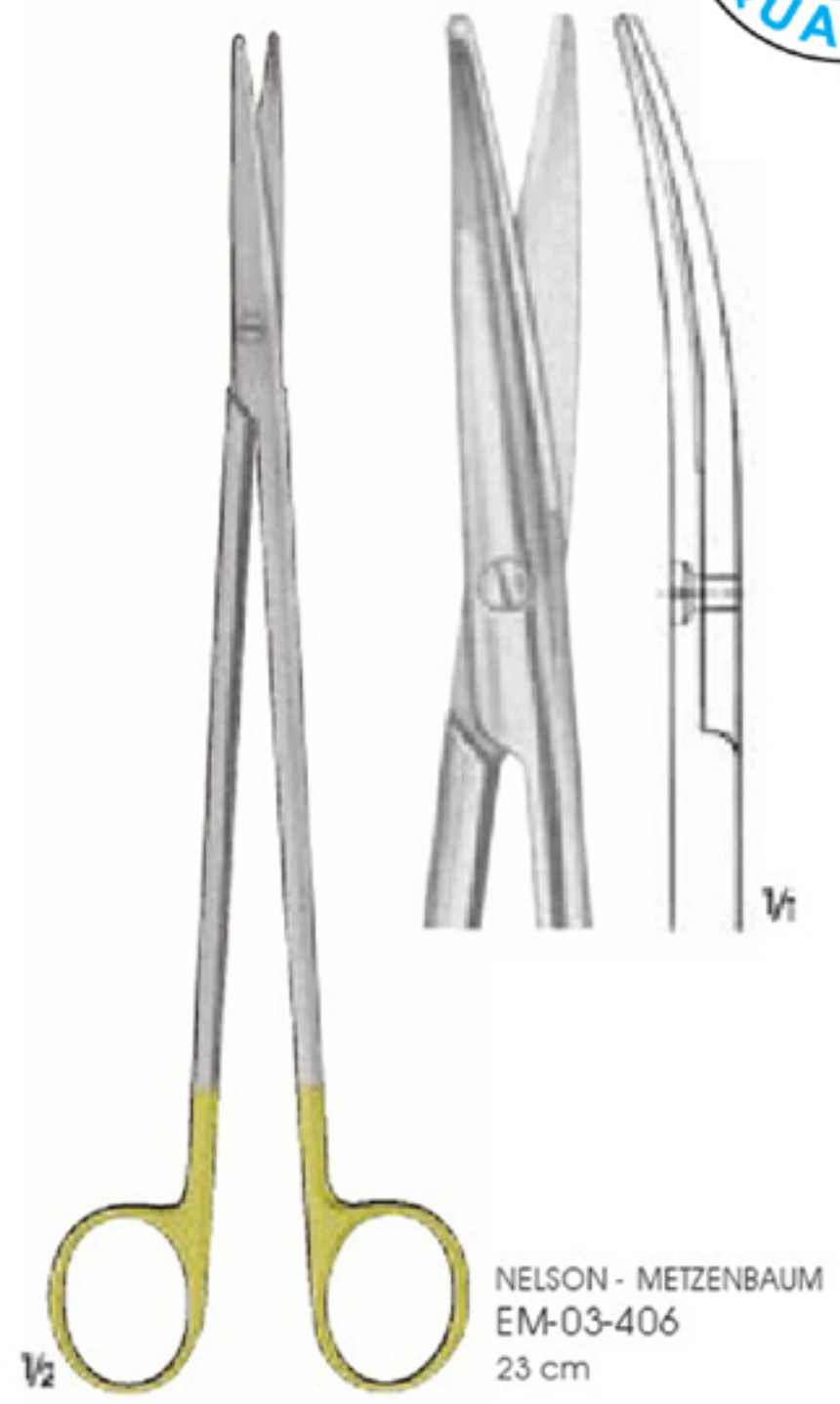



Dikiş malzemelerinin kesimi için ;

- *GripCut* makasın üzerindeki karbid uçları kalıcı keskinlik sağlar. (Makas ağzının uçları da dahil)
- *GripCut* makasın üzerindeki Tırtıklı ağız dikiş malzemelerinin dışarıya kaymasını engeller.

Cutting suture materials;

- Carbide inserts on *GripCut* scissors provide lasting sharpness. (including tip of the blades of the scissors)
- Serrated edges on *GripCut* scissors prevents suture materials from slipping out.







EM-03-416
11.5 cm



BABY-METZENBAUM
EM-03-417
14.5 cm



METZENBAUM
EM-03-418-01 - 419-02

MAYO-LEXER
EM-03-420-01 - 420-02
16.5 cm



GripCut kesme sırasında dokunun kaymasını engeller.

GripCut prevents tissue from slipping out during the cutting process

