

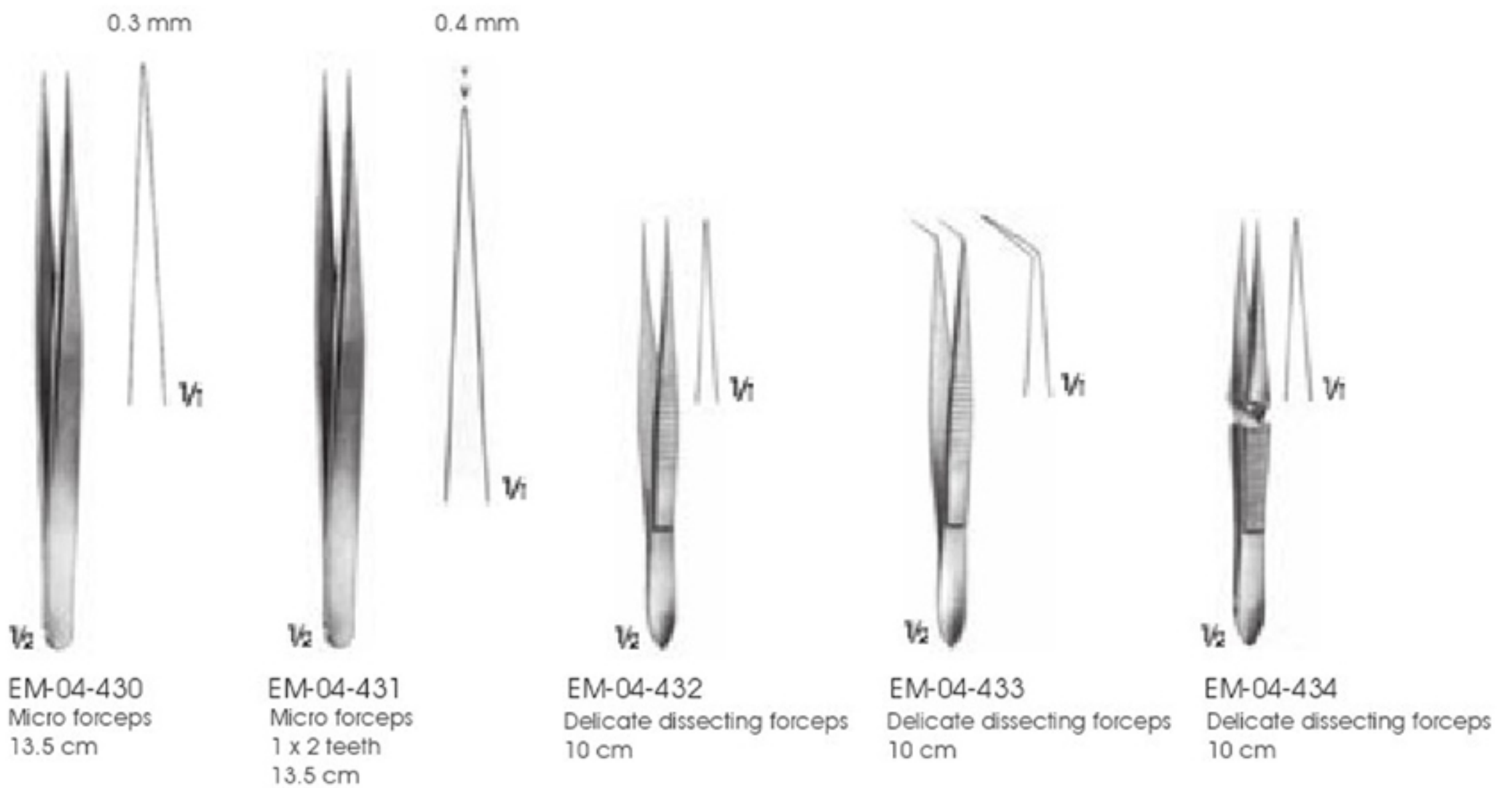

# Forceps Zange

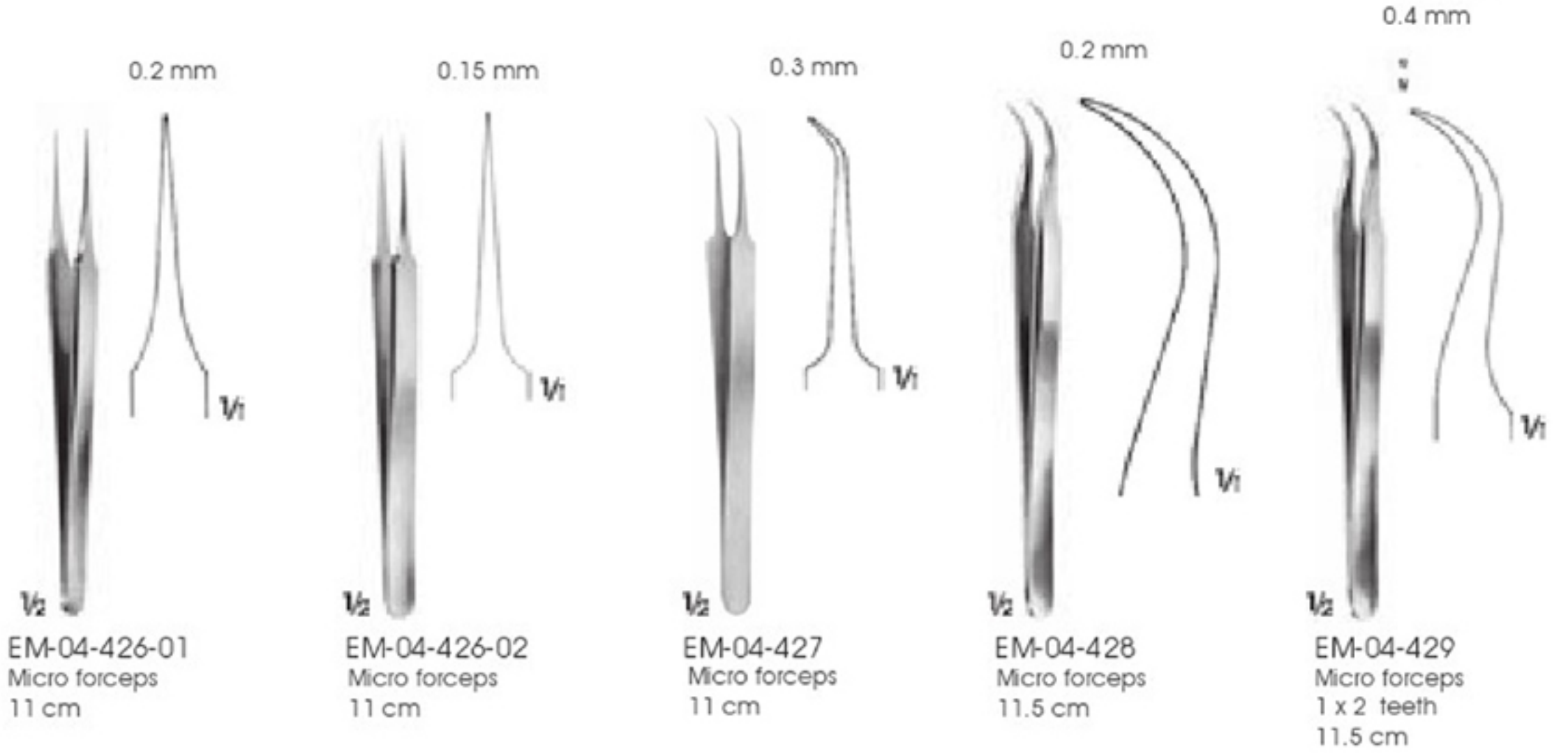

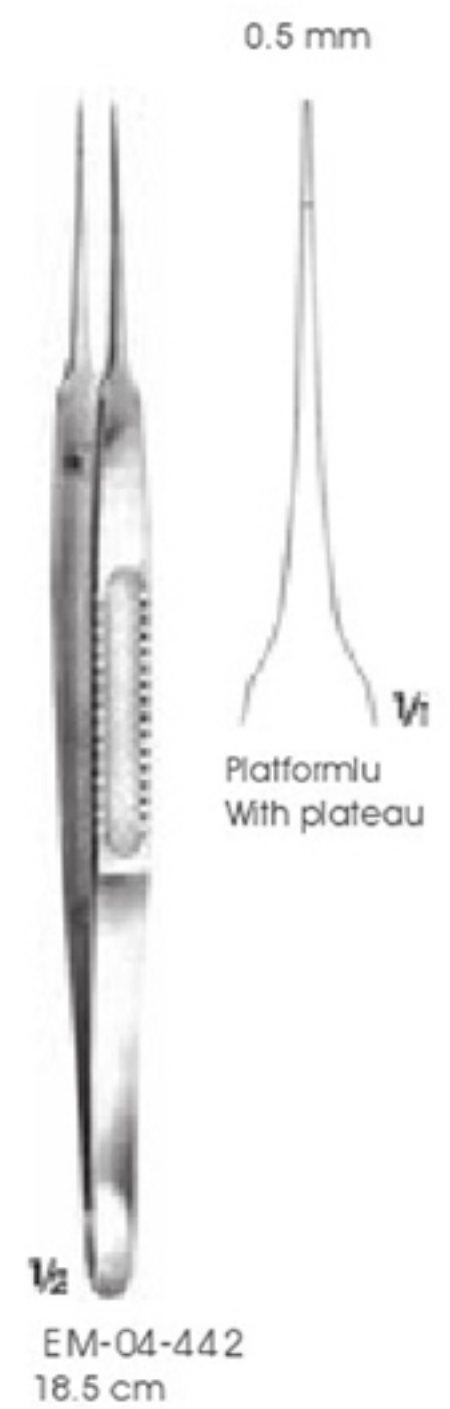
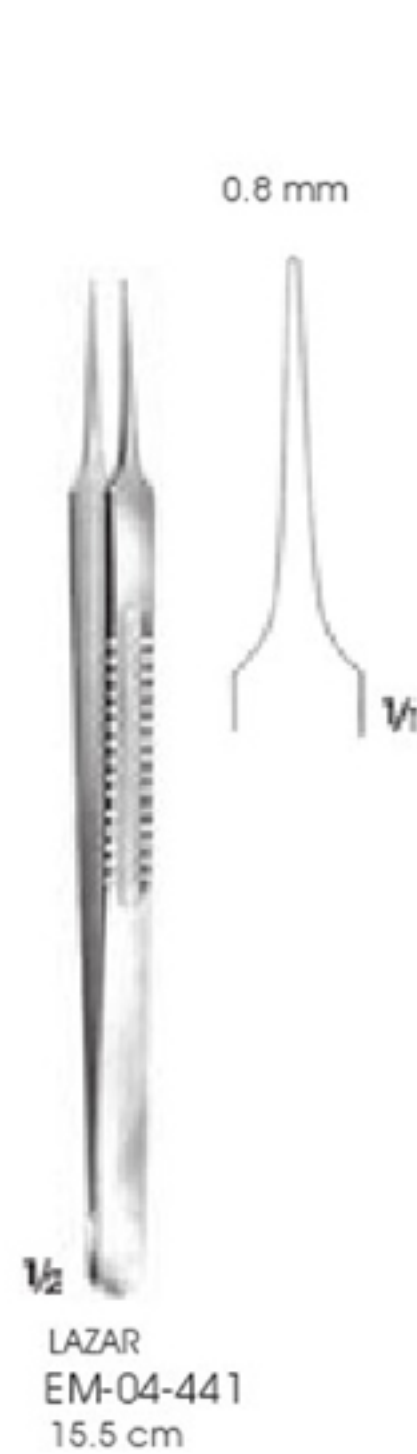
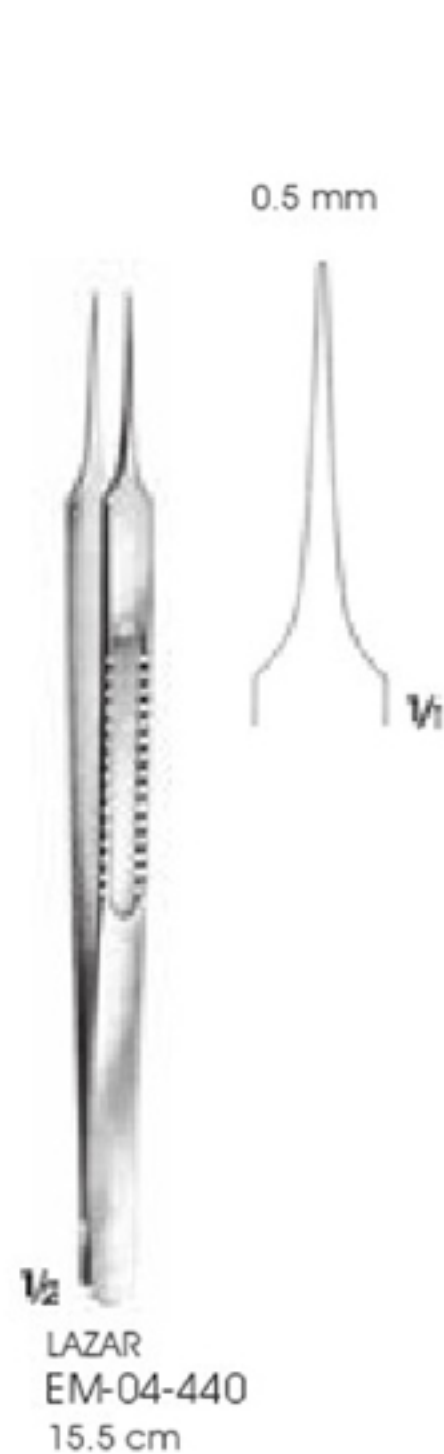
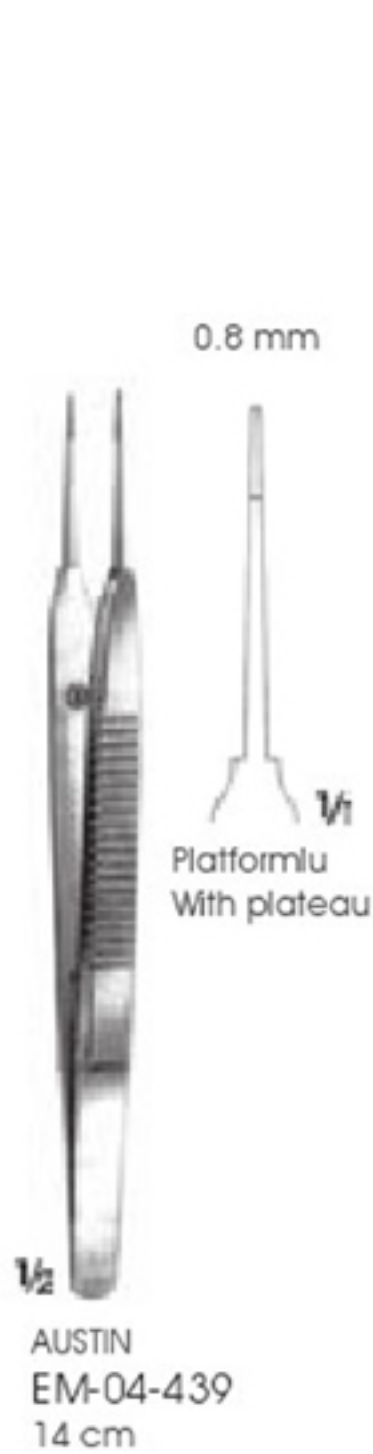

Lightweigh plastic handles to increase grip surface:

- Provides cramp free ,natural holding positions and sensitivity
- Round cross-section of the instrument provides an easy and smooth rotation.Expands the working and application area.
- Retention profile with pin ensures safe gripping.
- Ergonomic, light weight plastic handle provides fatigue free, optimal usage.

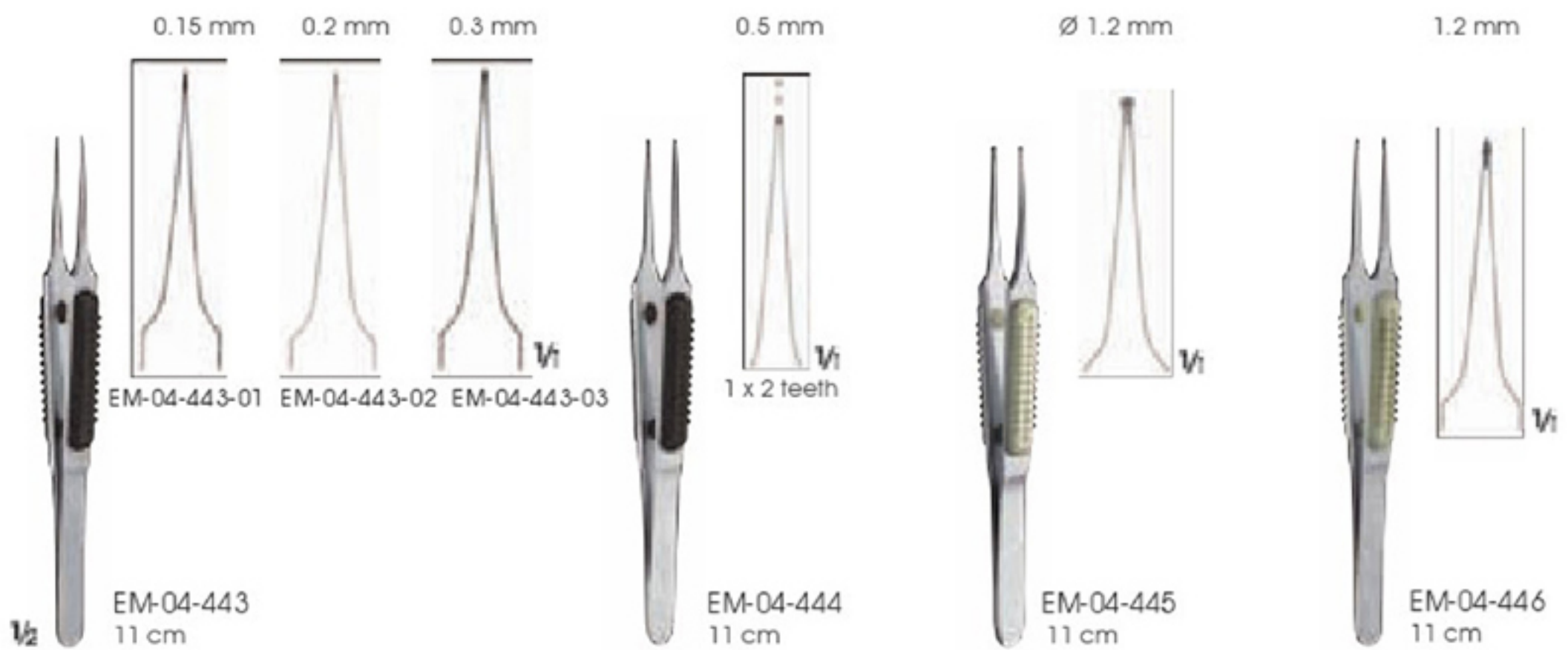



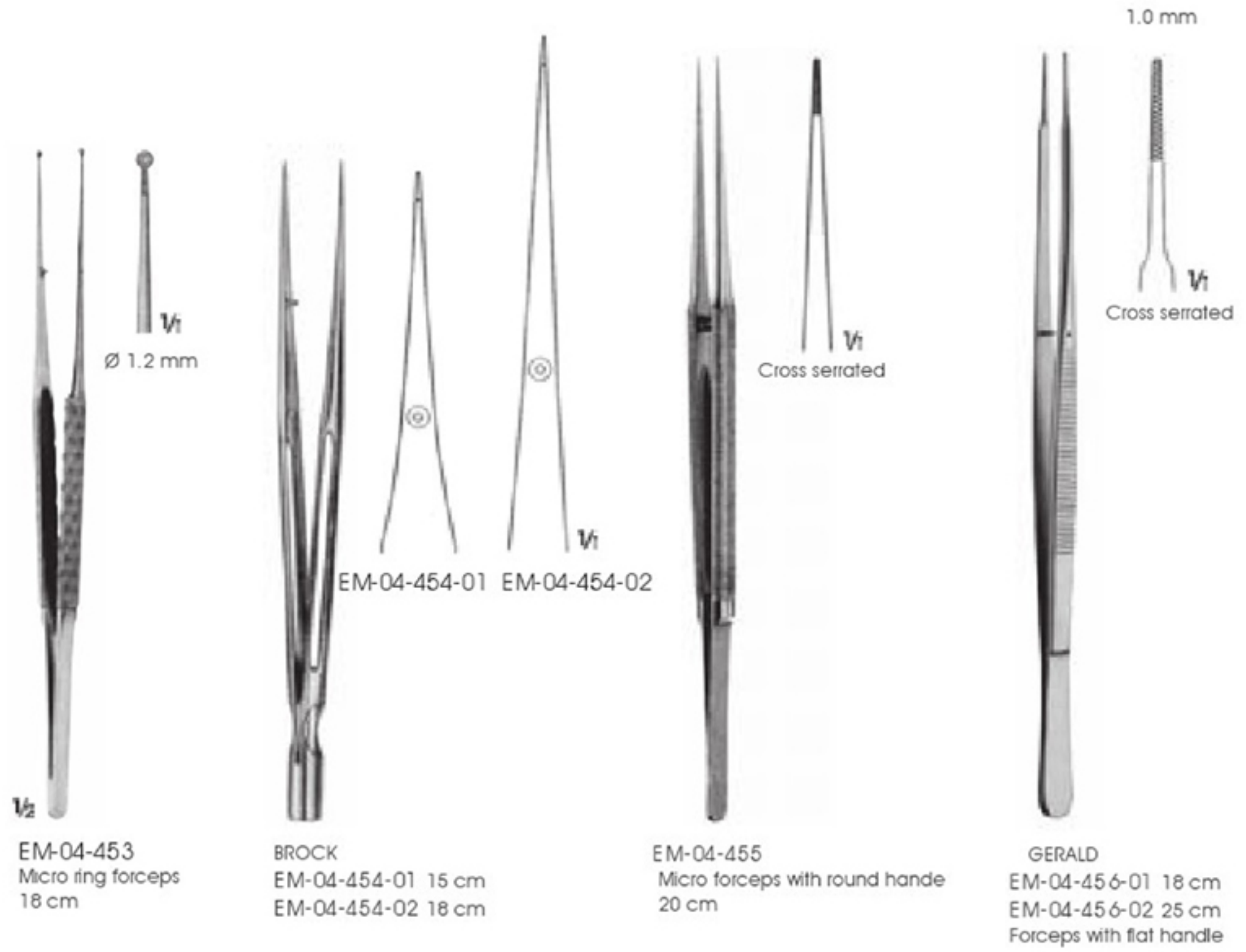
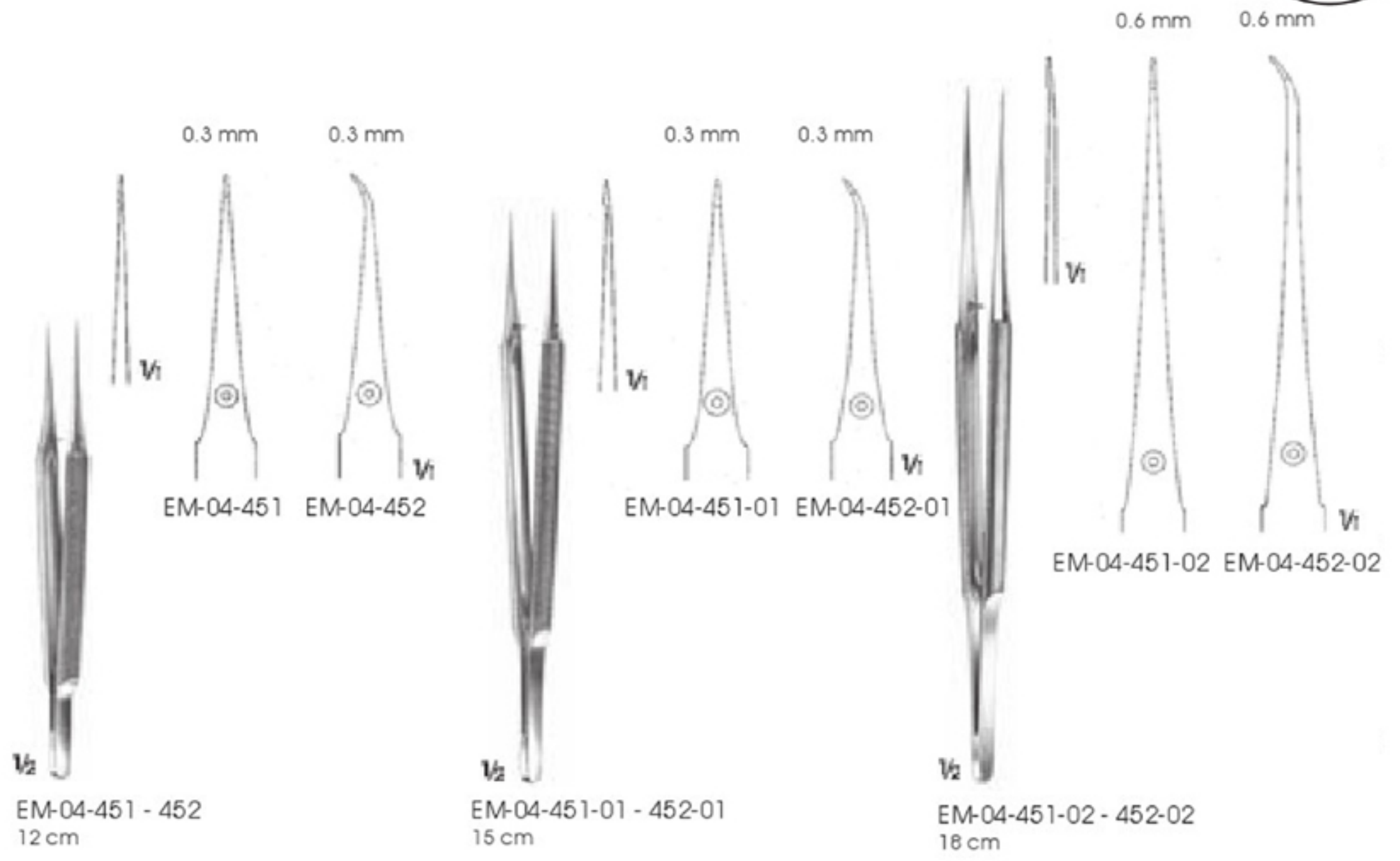

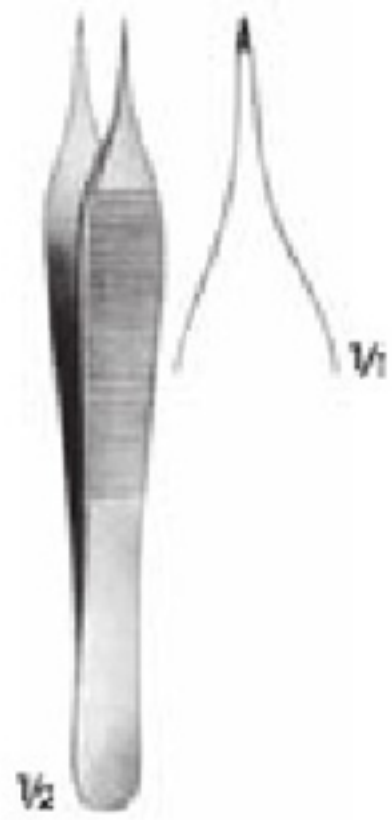

THORPE  
EM-04-457  
Korneal penset  
Corneal forceps  
12 cm

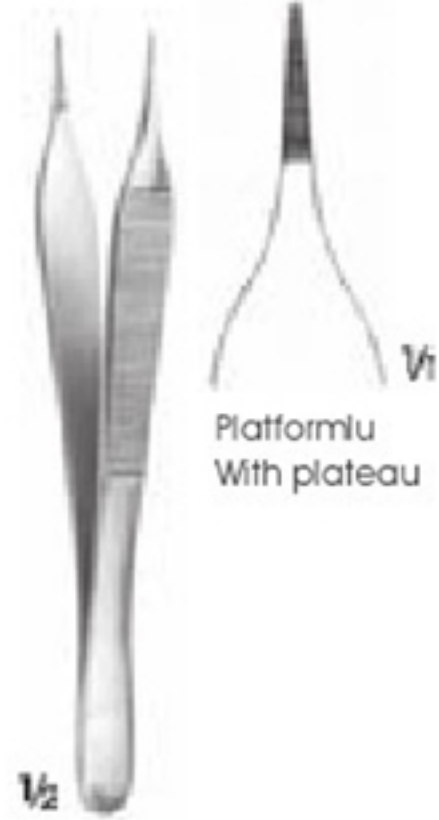

MICRO-ADSON  
EM-04-458  
12 cm

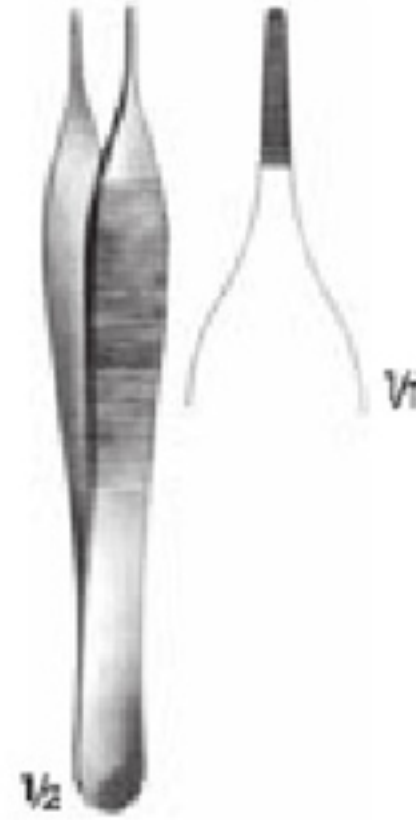

ADSON  
EM-04-459  
12 cm

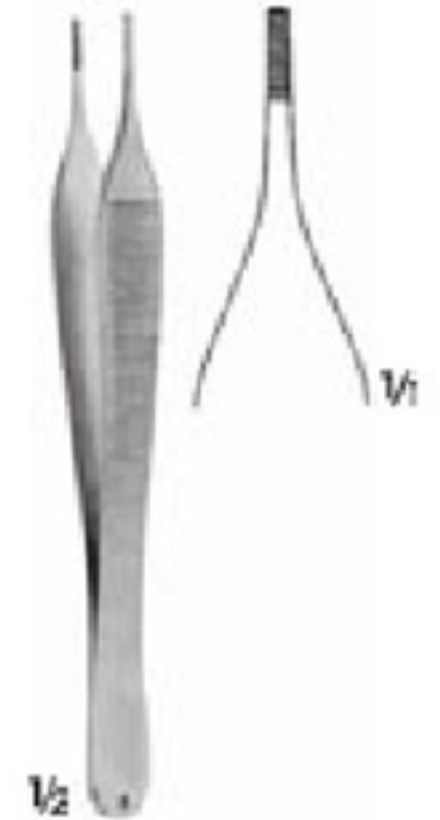

HUDSON  
EM-04-460  
12.5 cm

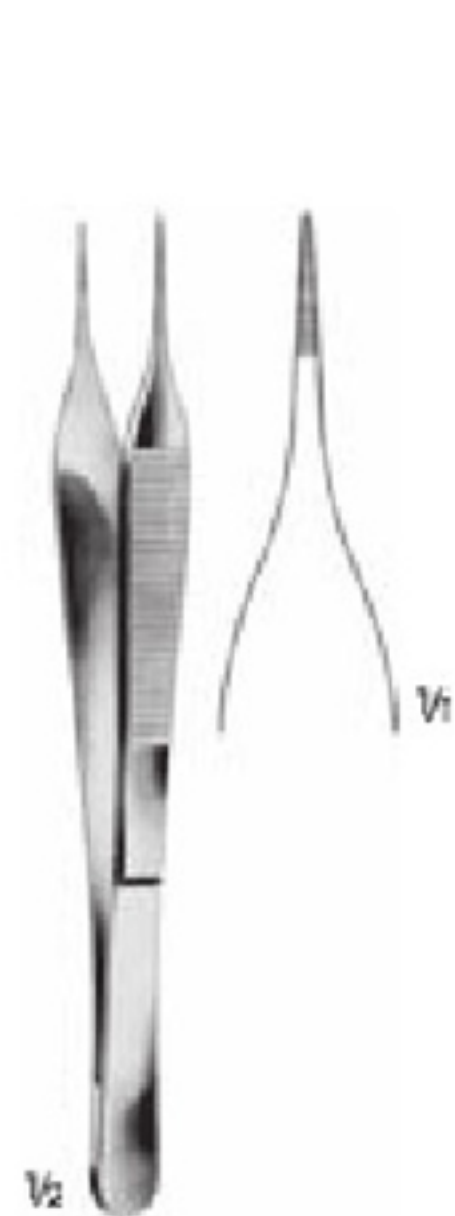

MICRO-ADSON  
EM-04-461  
15 cm

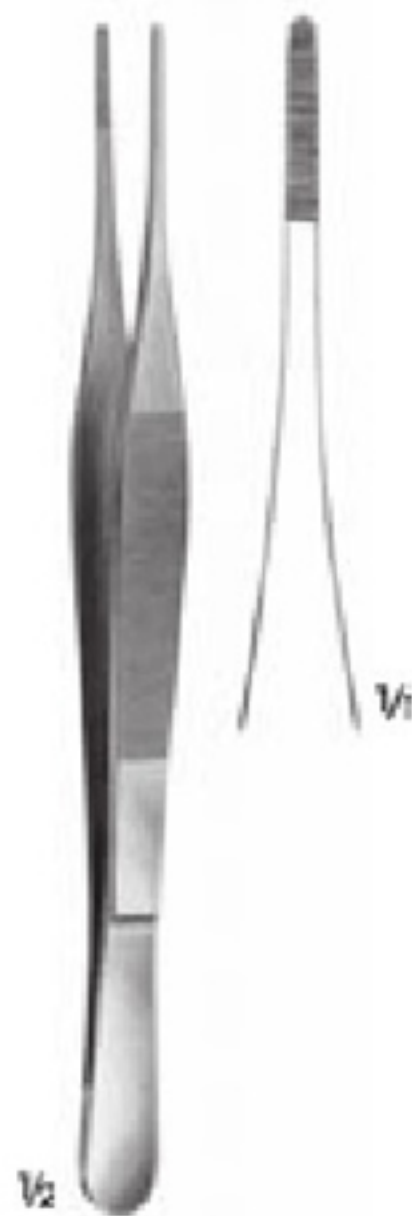

ADSON  
EM-04-462  
18 cm

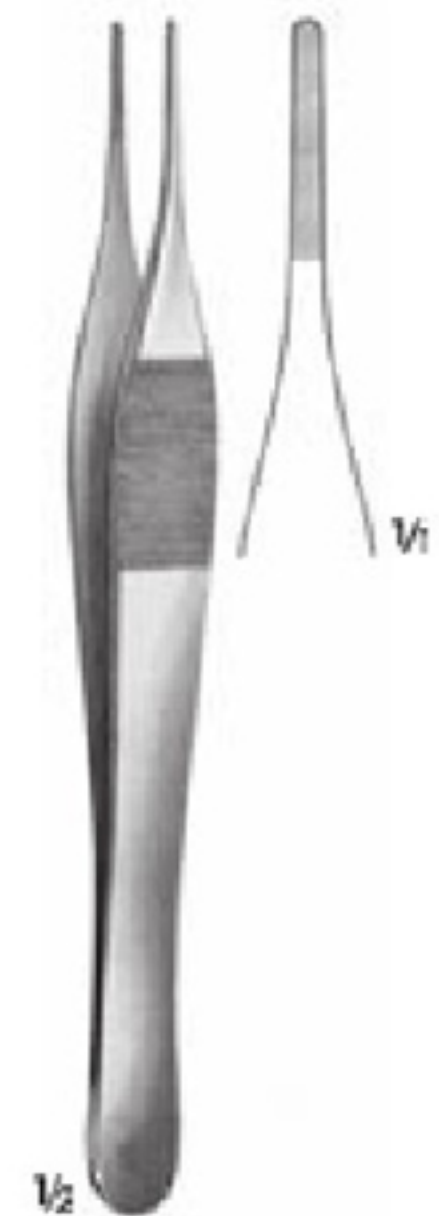

JEFFERSON  
EM-04-463  
18 cm

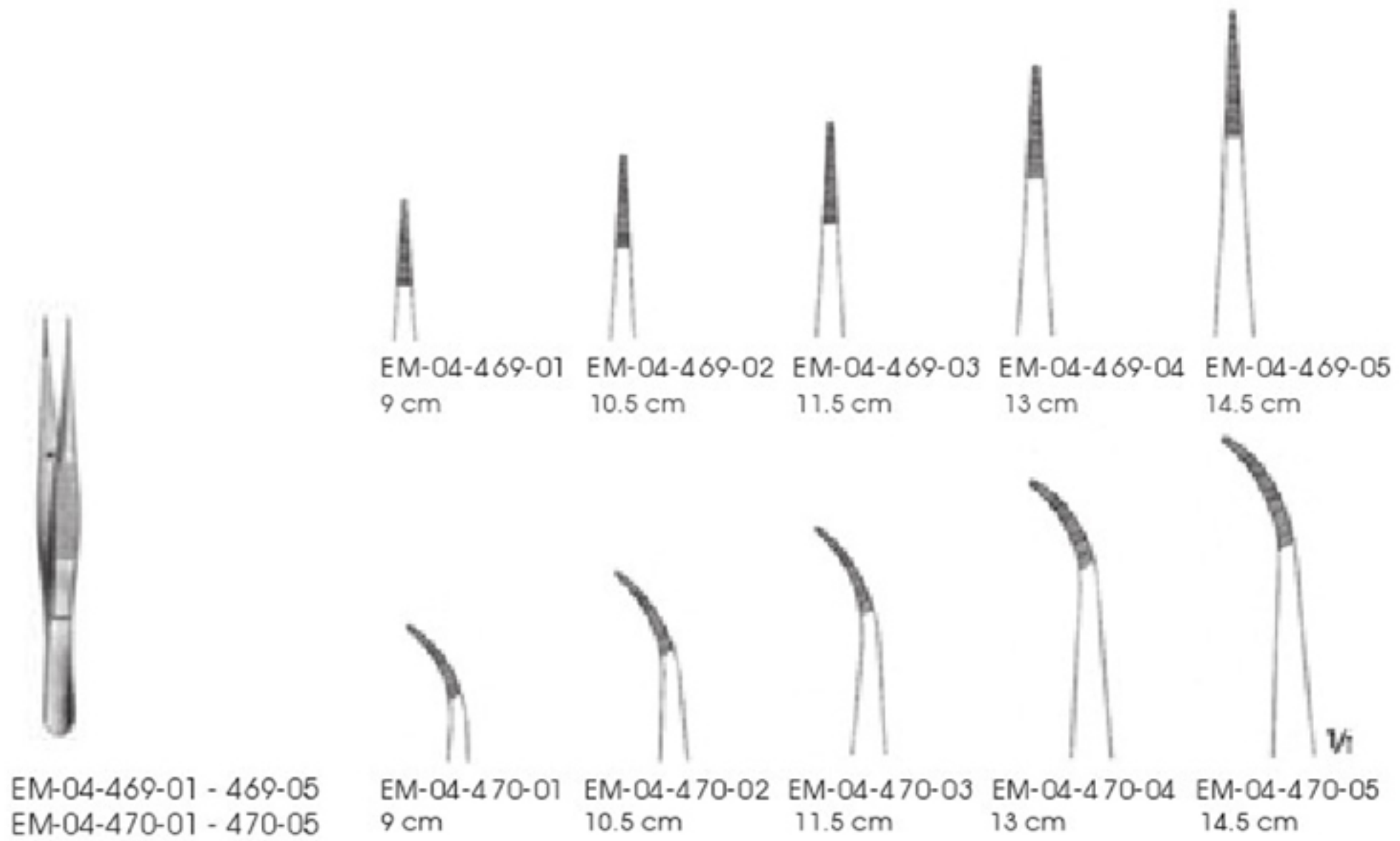
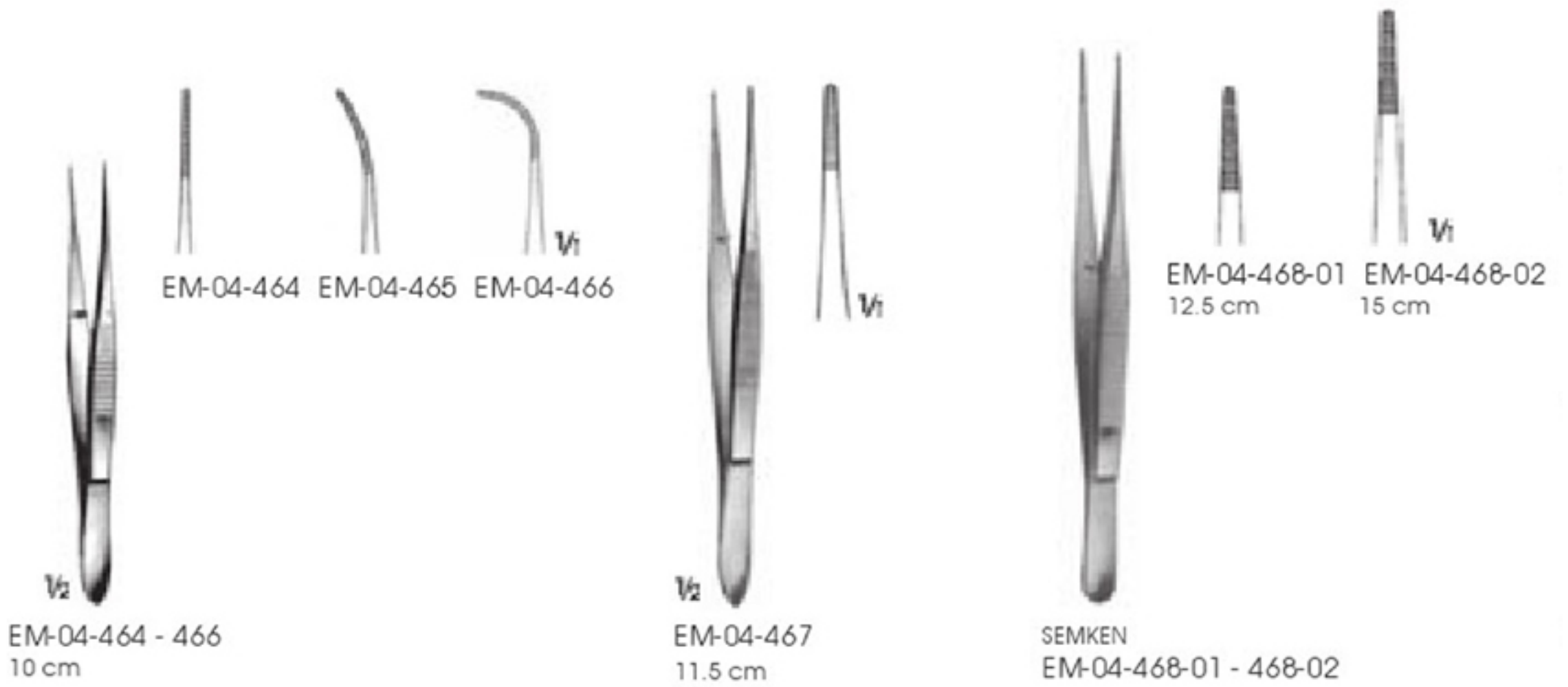



GILLIES  
EM-04-471  
15 cm

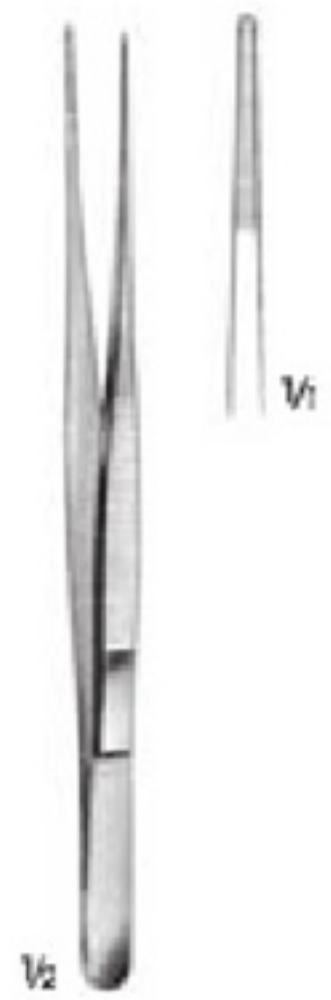

EM-04-472  
15.5 cm

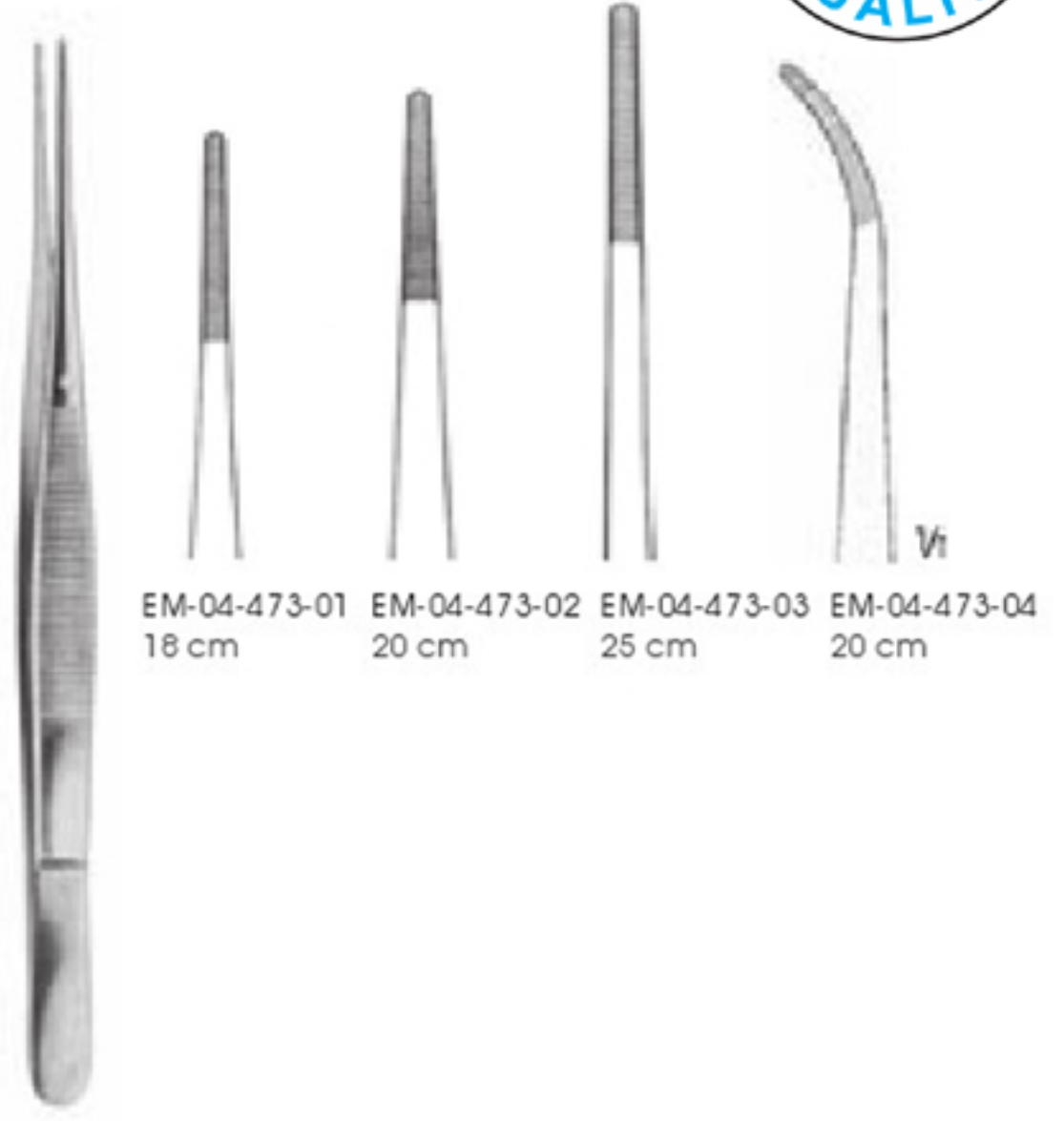

CUSHING  
EM-04-473-01 - 473-04

EM-04-473-01 18 cm  
EM-04-473-02 20 cm  
EM-04-473-03 25 cm  
EM-04-473-04 20 cm



GERALD  
EM-04-474-01 - 475

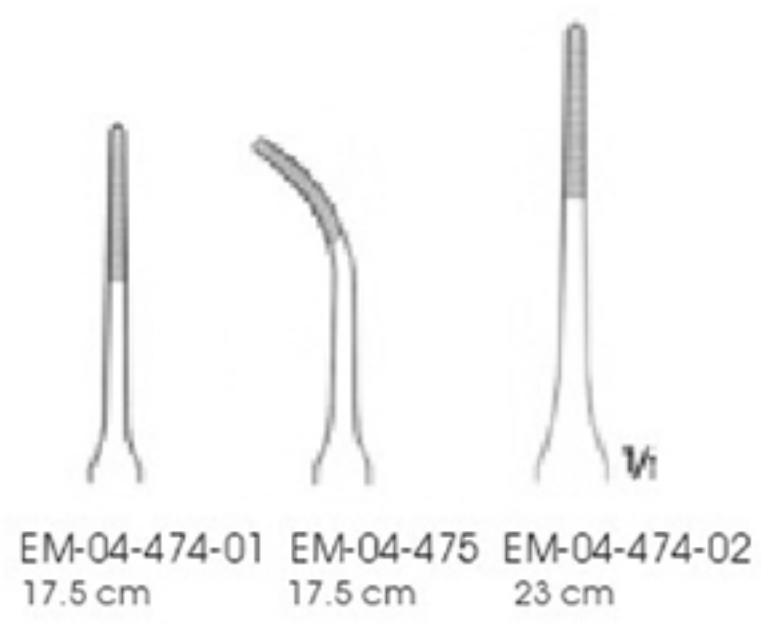

EM-04-474-01 17.5 cm  
EM-04-475 17.5 cm  
EM-04-474-02 23 cm

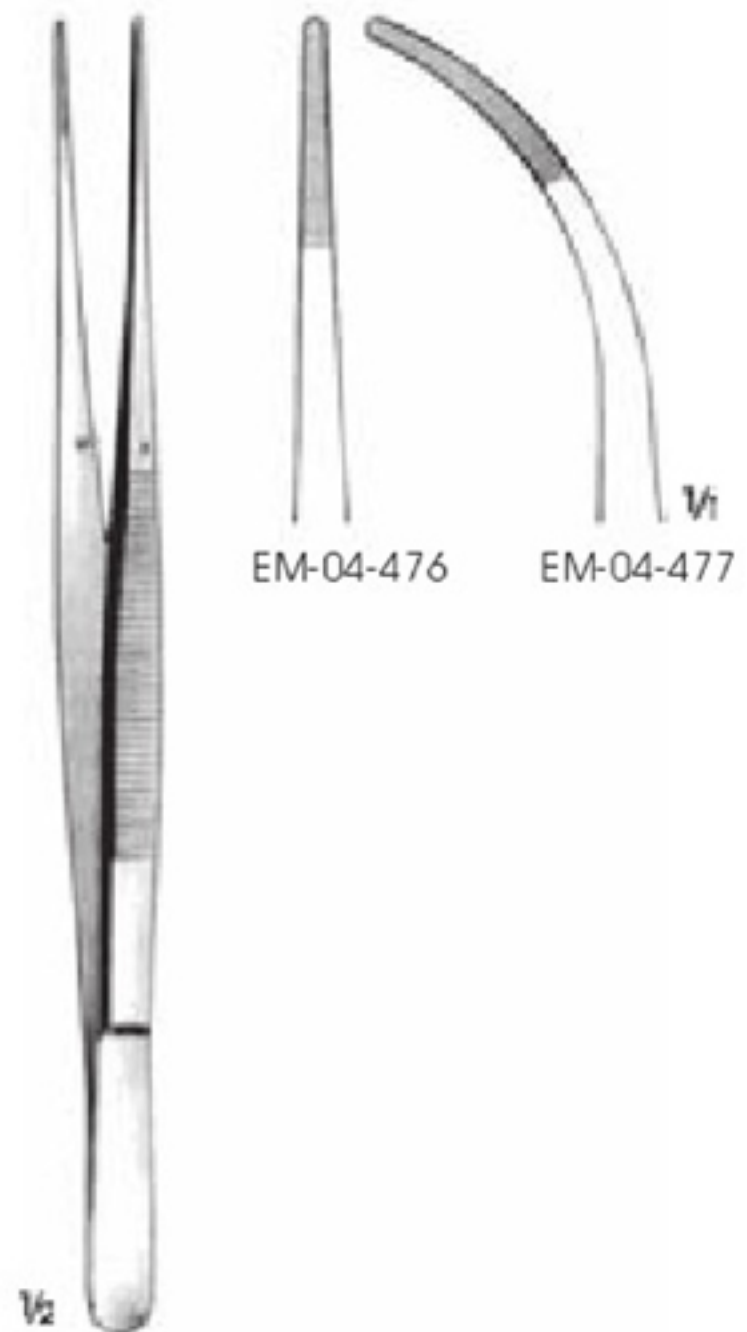

BROPHY  
EM-04-476 - 477  
20 cm

EM-04-476  
EM-04-477



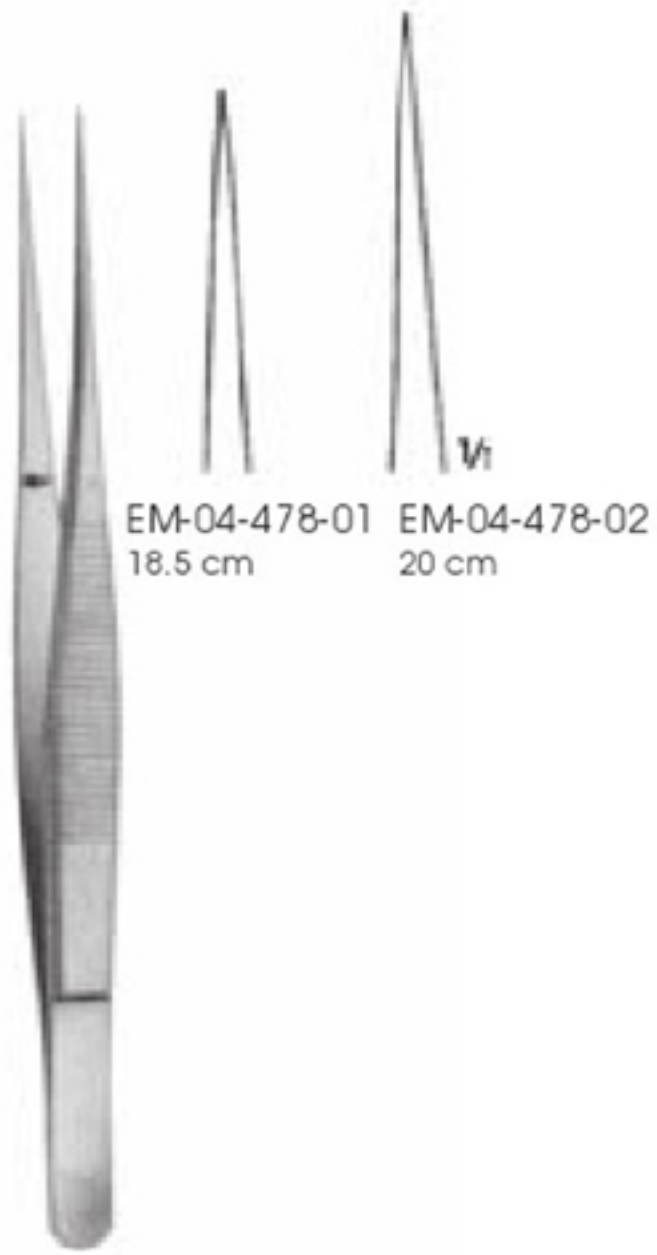

EM-04-478-01 - 478-02  
Smooth jaws



COOLEY  
EM-04-479  
20 cm

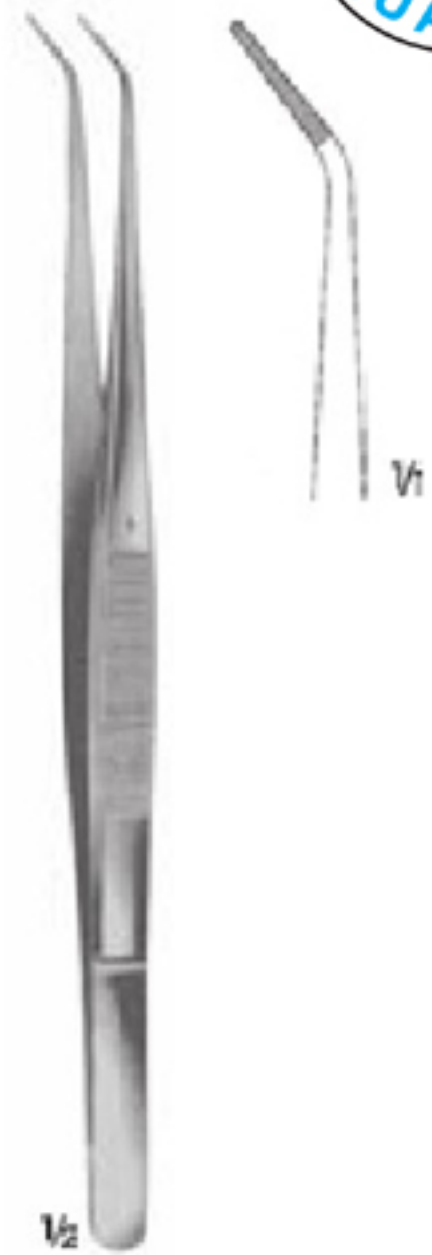

EM-04-480  
20 cm



MC INDOE  
EM-04-481  
15 cm



CAIRNS-DOTT  
EM-04-482-01 - 482-02

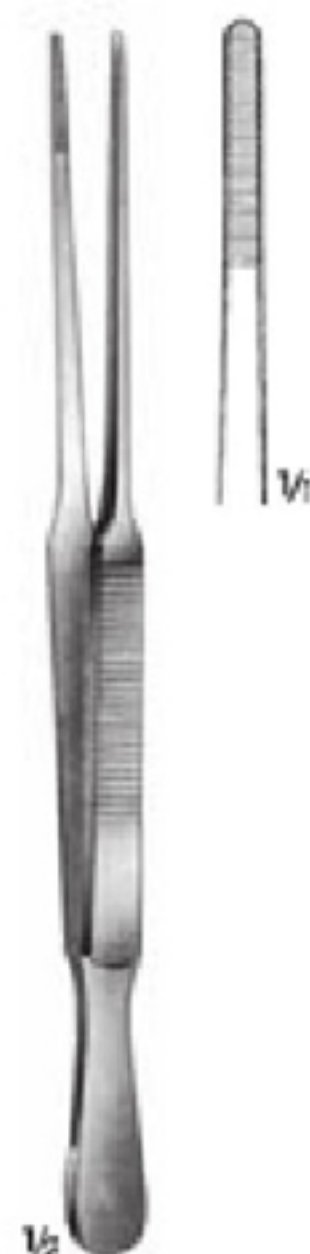

EM-04-483  
20 cm

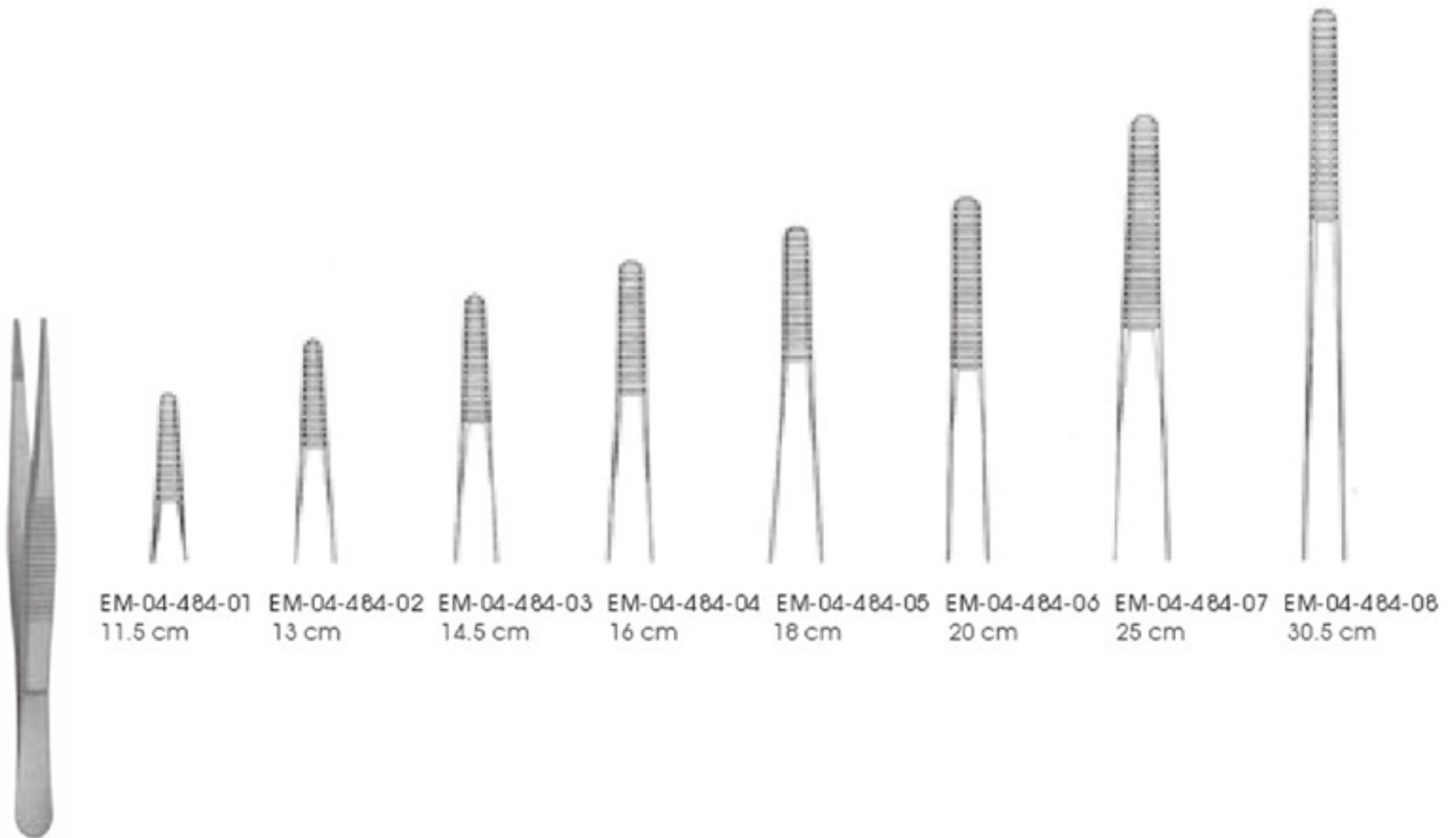

EM-04-484-01 11.5 cm    EM-04-484-02 13 cm    EM-04-484-03 14.5 cm    EM-04-484-04 16 cm    EM-04-484-05 18 cm    EM-04-484-06 20 cm    EM-04-484-07 25 cm    EM-04-484-08 30.5 cm

EM-04-484-01 - 484-08  
Medium

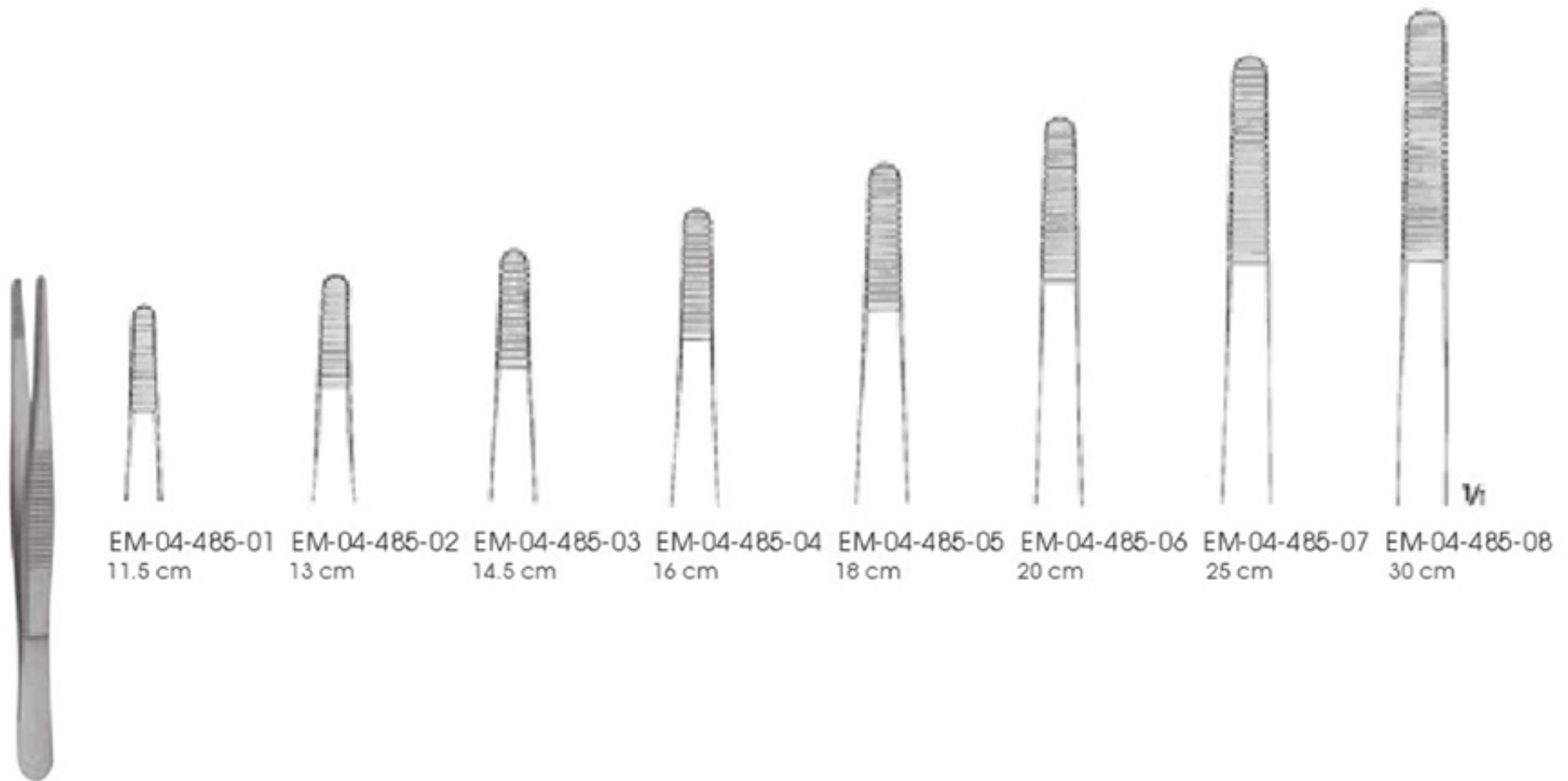

EM-04-485-01 11.5 cm    EM-04-485-02 13 cm    EM-04-485-03 14.5 cm    EM-04-485-04 16 cm    EM-04-485-05 18 cm    EM-04-485-06 20 cm    EM-04-485-07 25 cm    EM-04-485-08 30 cm

EM-04-485-01 - 485-08  
Standard pattern



$\frac{1}{2}$   
 EM-04-486  
 Extra Large  
 Dissecting forceps  
 14.5 cm

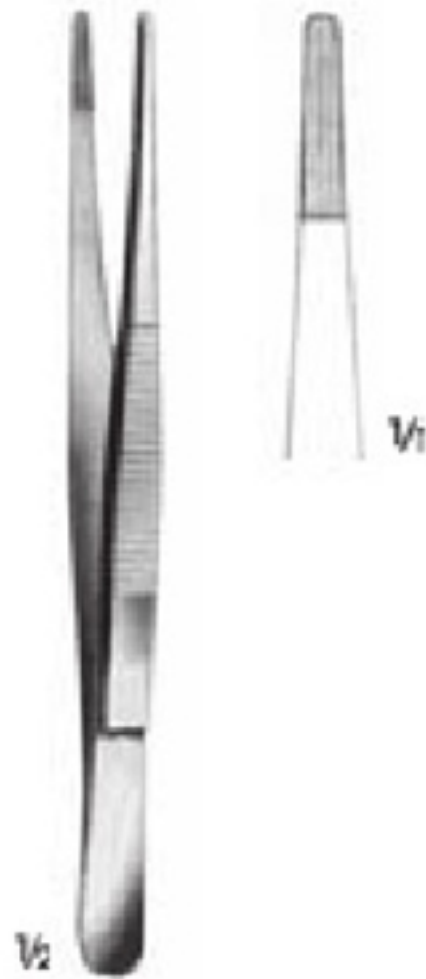

$\frac{1}{2}$   
 OCHSNER  
 EM-04-487  
 Ligature forceps  
 14.5 cm



EM-04-488-01 - 488-02  
 Medium  
 Dissecting forceps

EM-04-488-01 13 cm  
 EM-04-488-02 14.5 cm

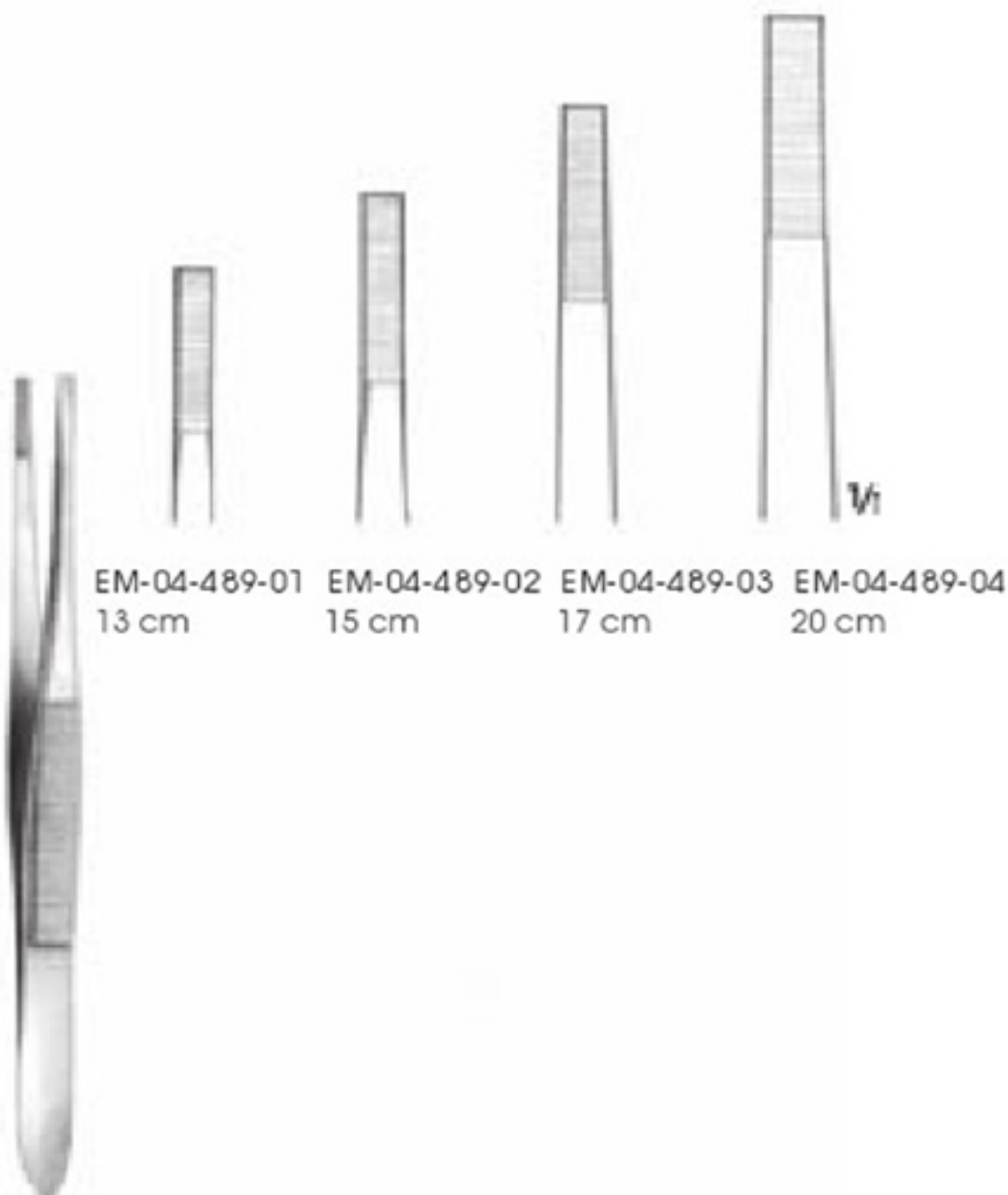

$\frac{1}{2}$   
 SCHWEDISCHES MODELL  
 EM-04-489-01 - 489-04  
 Dissecting forceps

EM-04-489-01 13 cm  
 EM-04-489-02 15 cm  
 EM-04-489-03 17 cm  
 EM-04-489-04 20 cm



$\frac{1}{2}$   
 BONNEY  
 EM-04-490  
 Dissecting forceps  
 17.5 cm

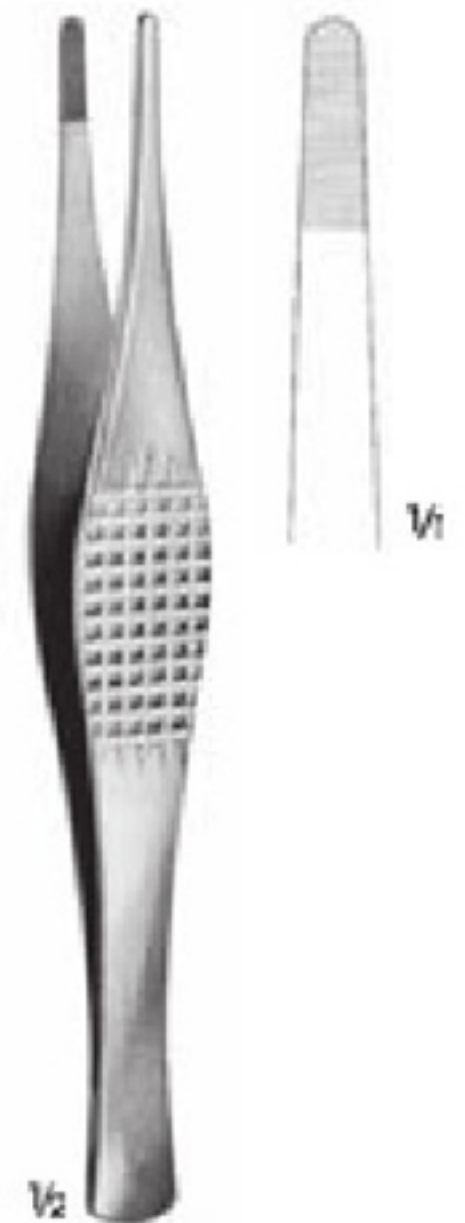

$\frac{1}{2}$   
 RAMSEY  
 EM-04-491  
 Dissecting forceps  
 18 cm





Toothing De Bakey

1.0 mm



DE BAKEY  
EM-04-492-01 18.5 cm  
EM-04-492-02 21 cm  
Mikro penseller  
Micro forceps  
With round handle

1.0 mm



DE BAKEY  
EM-04-493-01 18.5 cm  
EM-04-493-02 21 cm  
Mikro penseller  
Micro forceps  
With round handle

1.0 mm



DE BAKEY  
EM-04-494-01 18 cm  
EM-04-494-02 20 cm  
Mikro penset  
Micro forceps  
With round handle

1.0 mm



DE BAKEY  
EM-04-495-01 15 cm  
EM-04-495-02 19.5 cm  
EM-04-495-02 24 cm  
forceps

1.5 mm

2 mm



DE BAKEY  
EM-04-496 15 cm  
forceps

40°

Vt

1.5 mm

2 mm

2.3 mm



EM-04-497-01 15 cm  
EM-04-497-02 19.5 cm  
EM-04-497-03 24 cm

COOLEY  
EM-04-497-01 - 497-03  
forceps

1.2 mm

1.5 mm

1.5 mm



EM-04-498-01 15 cm  
EM-04-498-02 20 cm  
EM-04-498-03 24 cm  
EM-04-498-04 30 cm

EM-04-498-01 - 498-04  
Ultra-light forceps



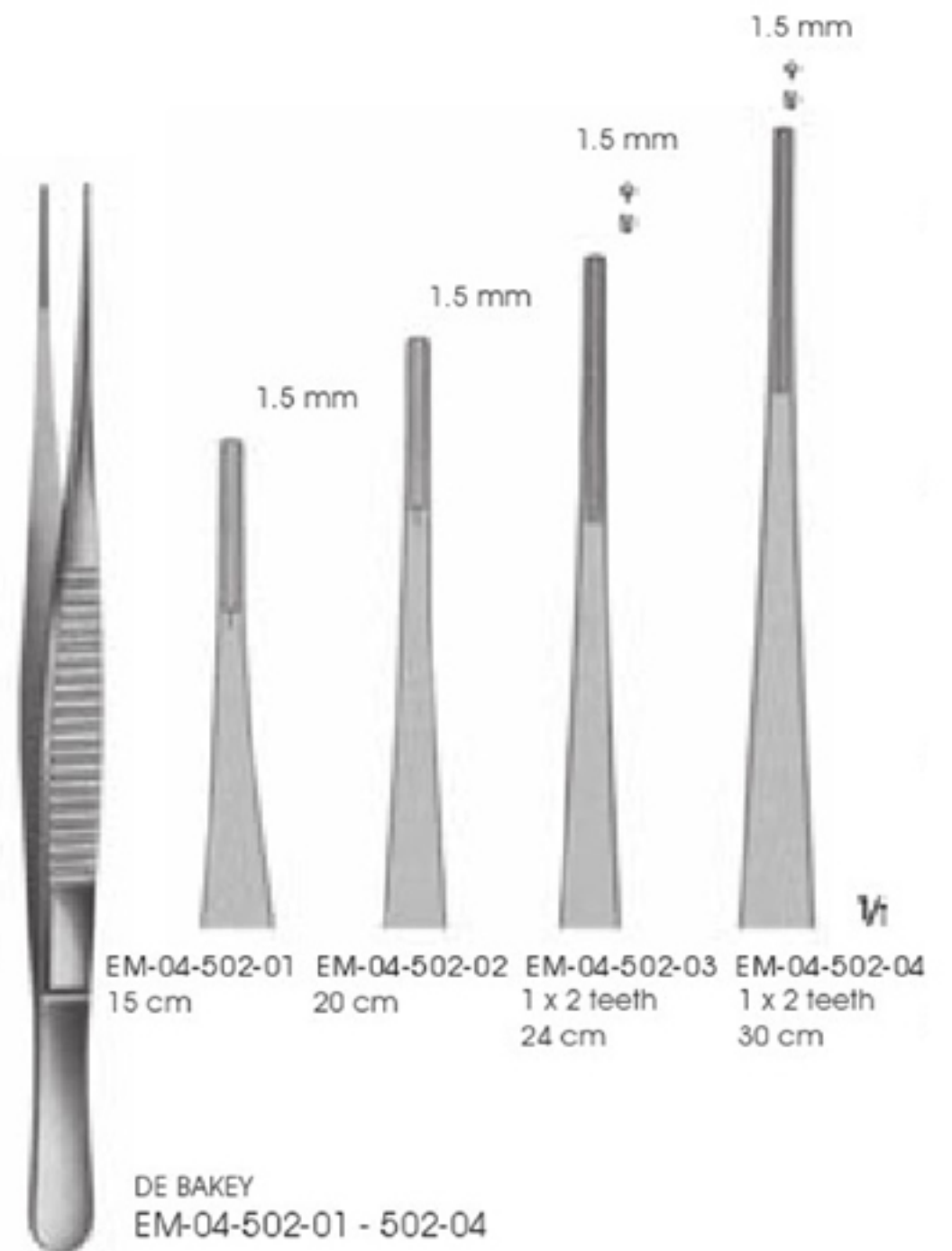
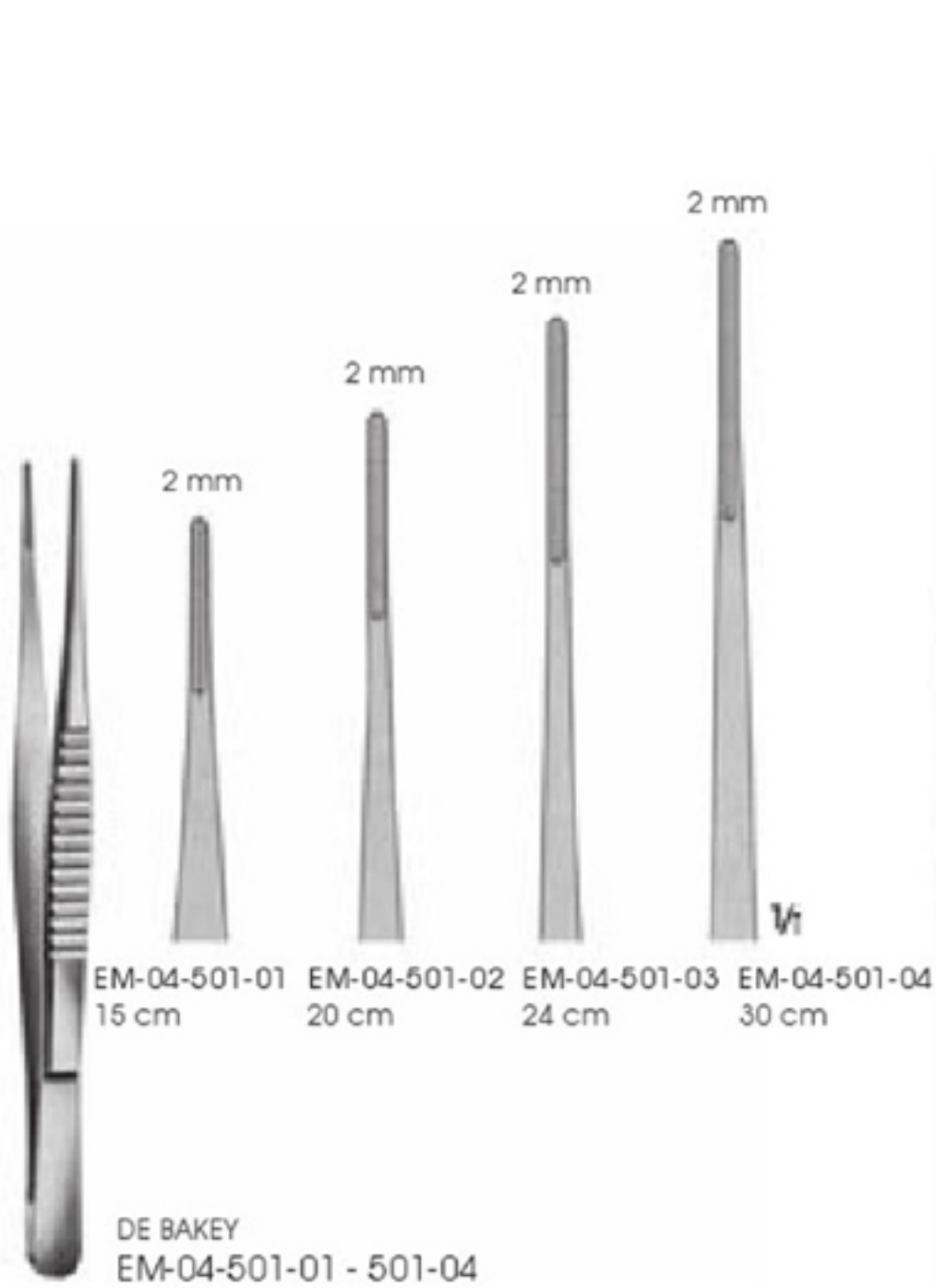
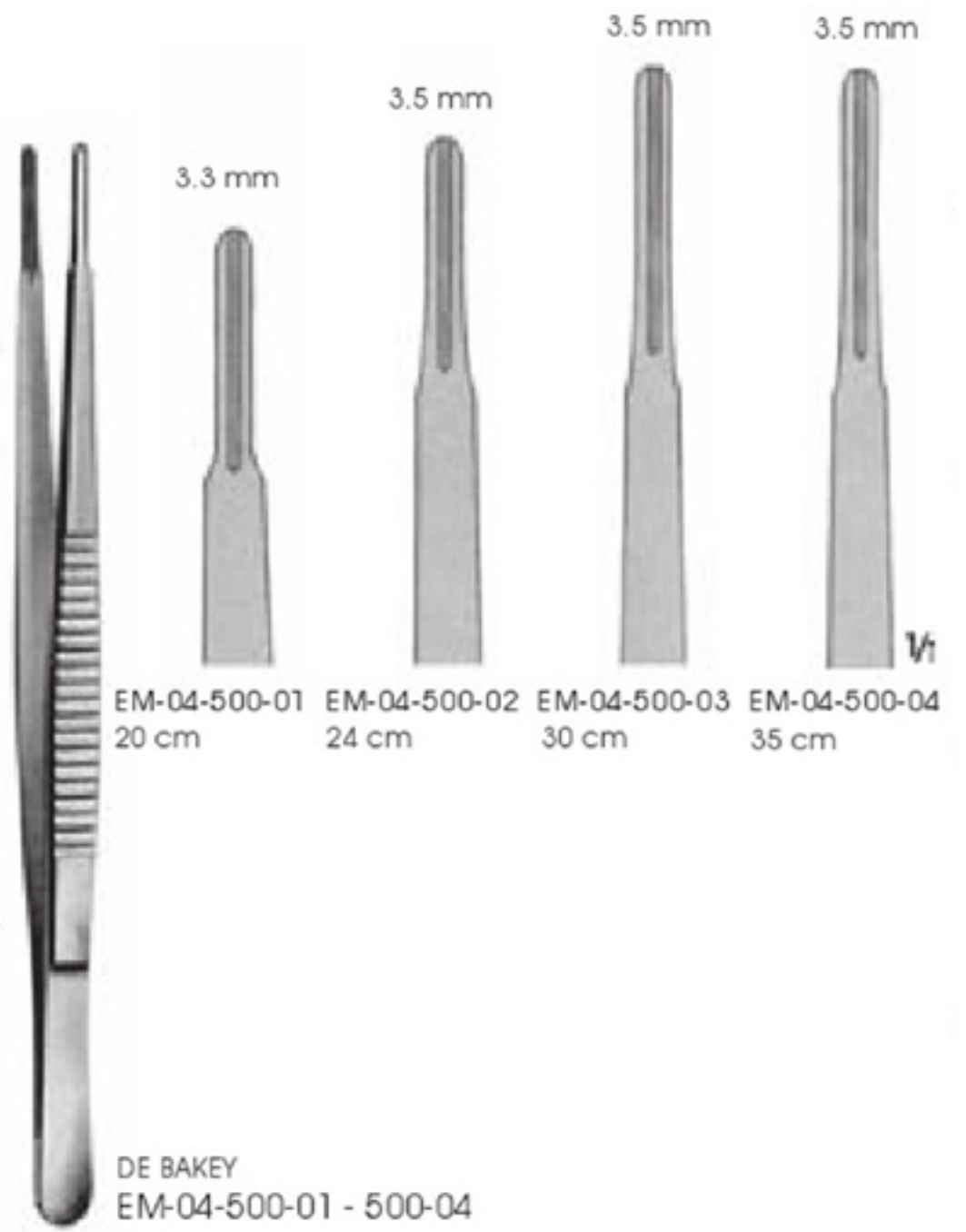
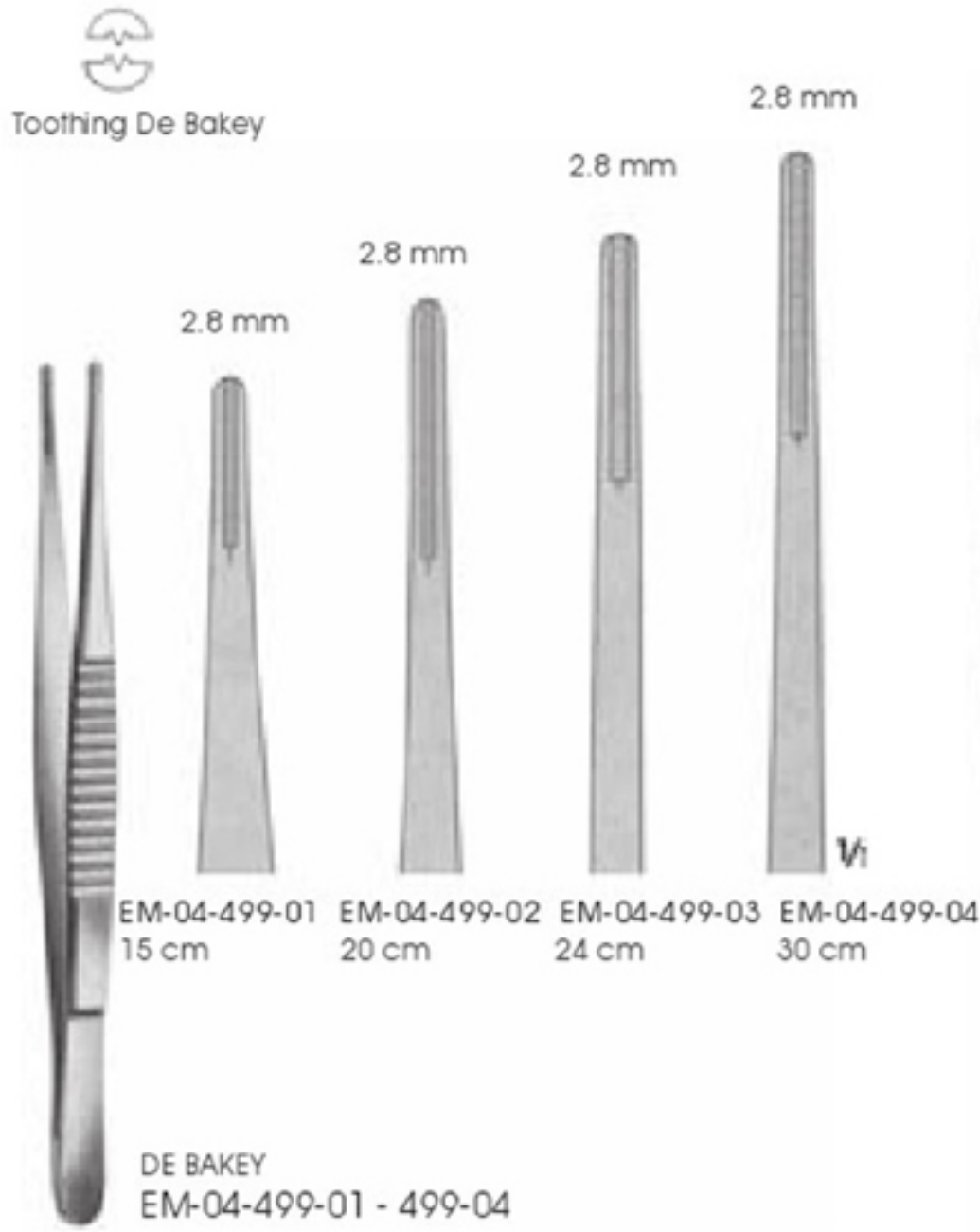

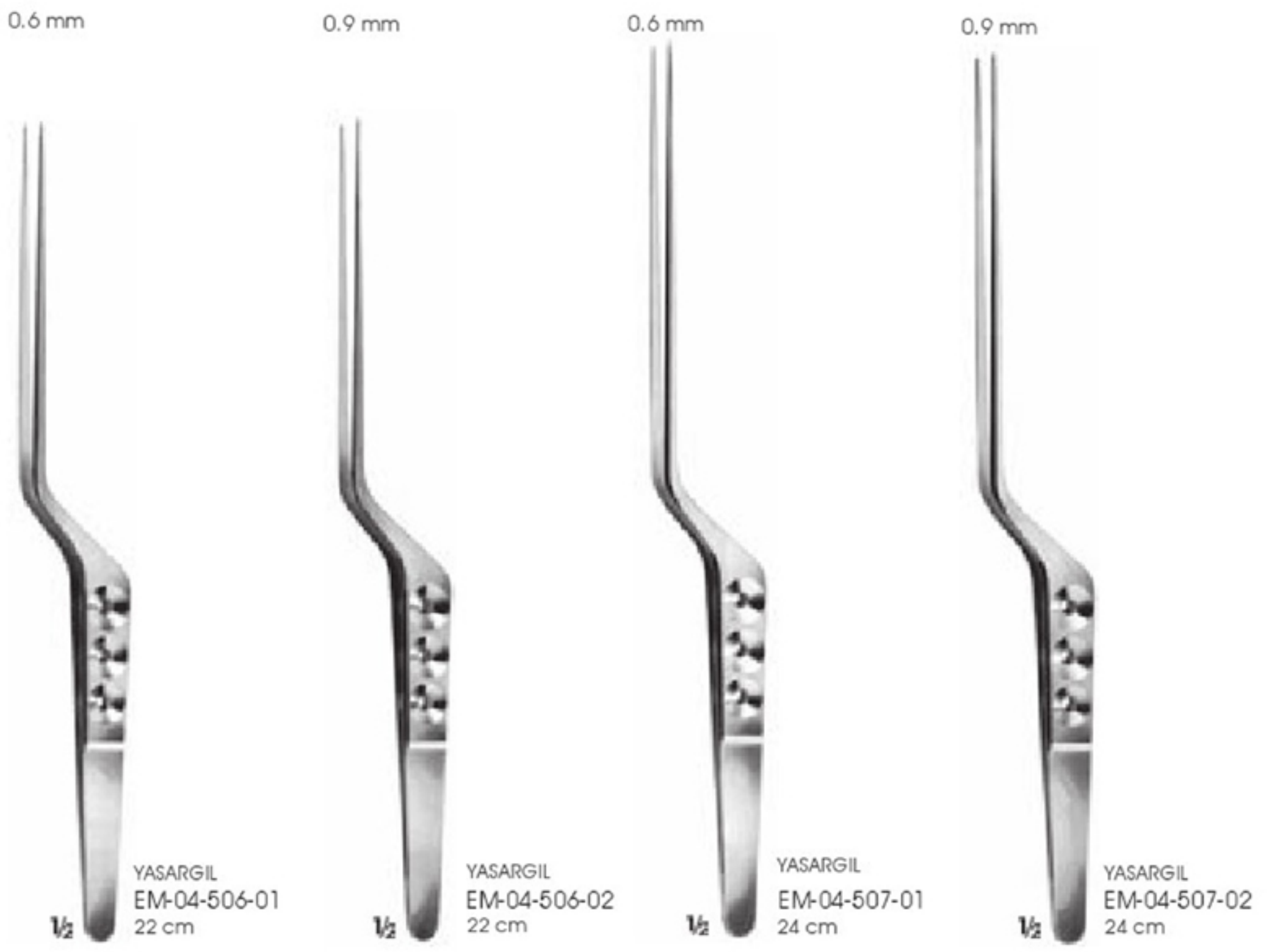

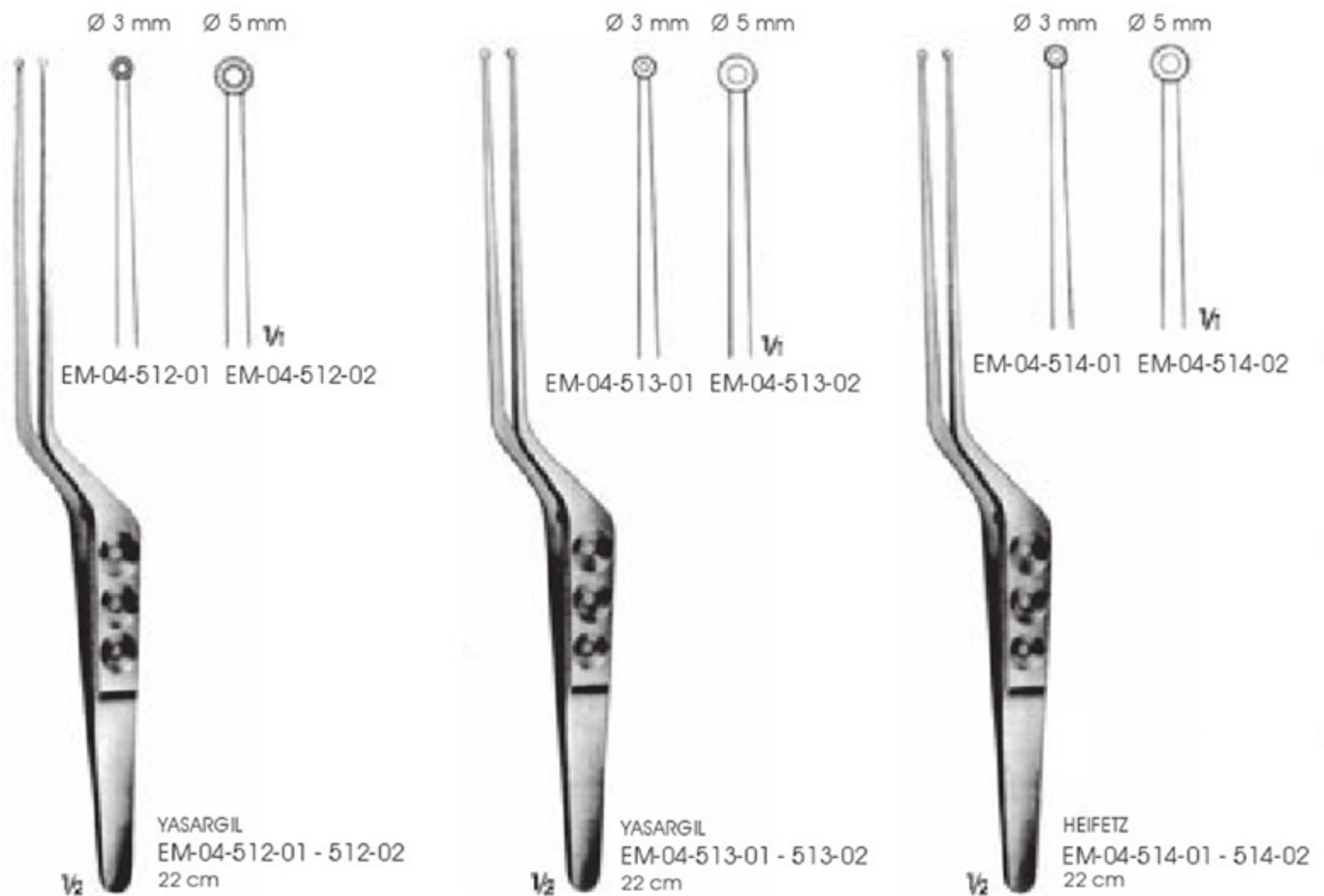
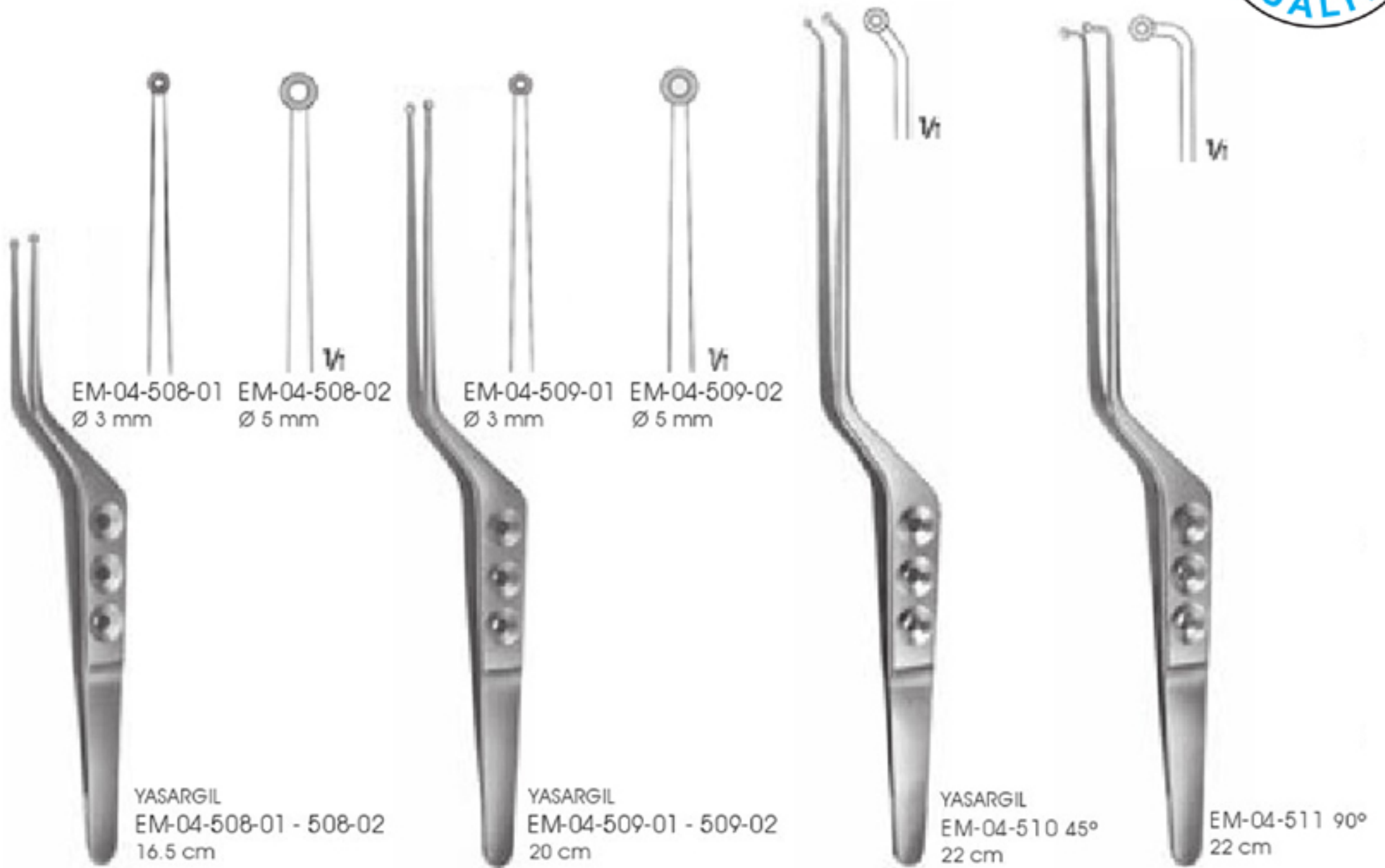



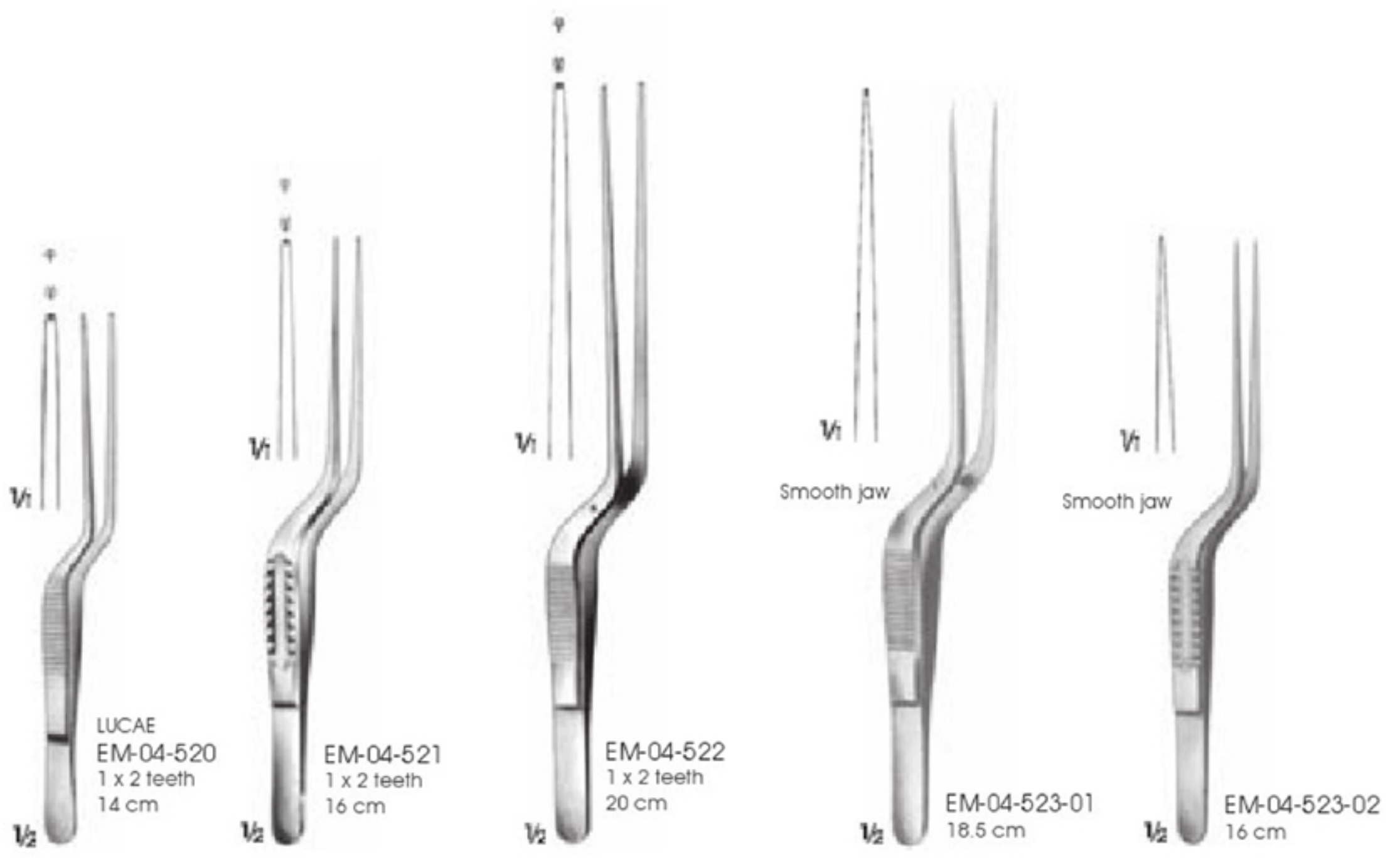
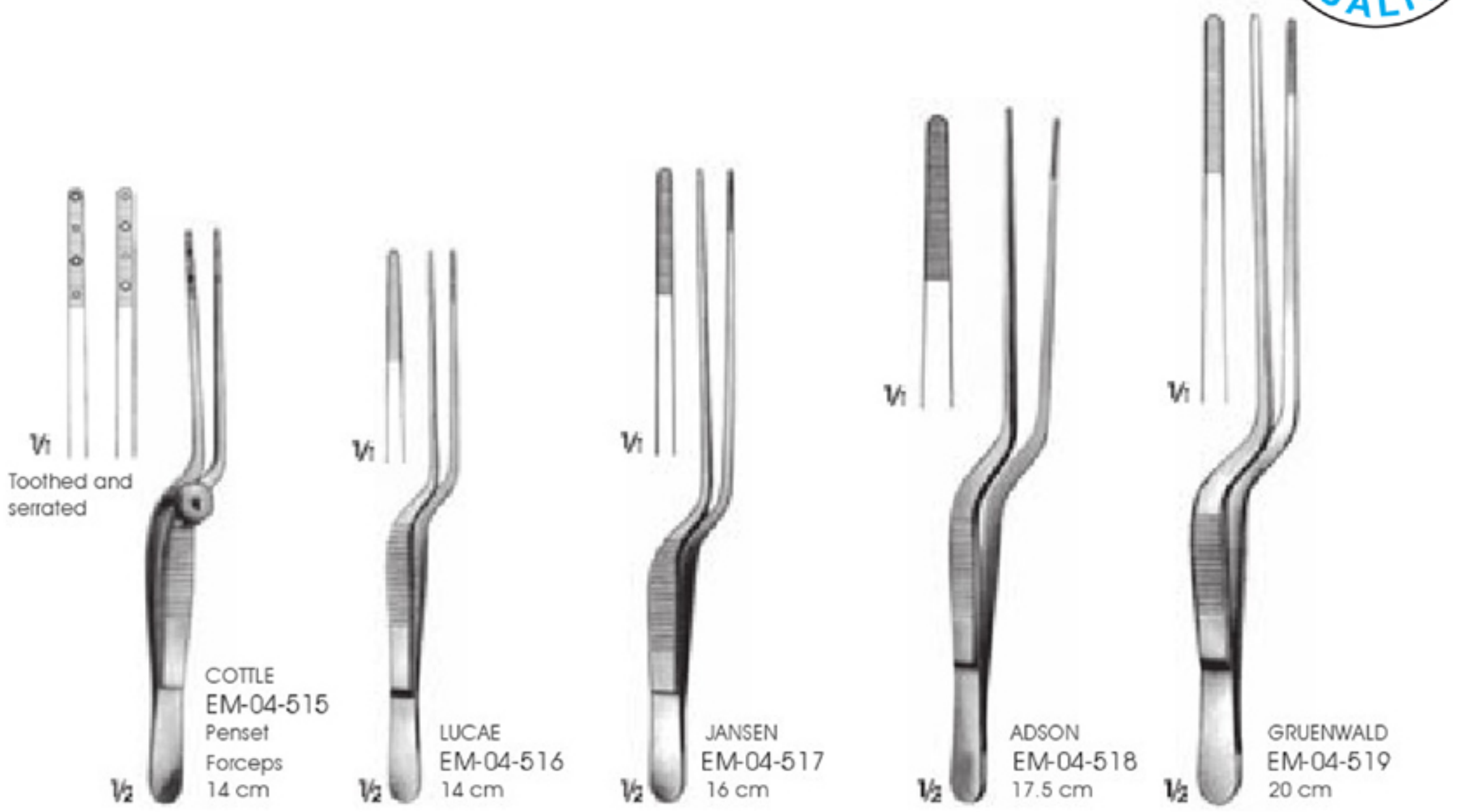



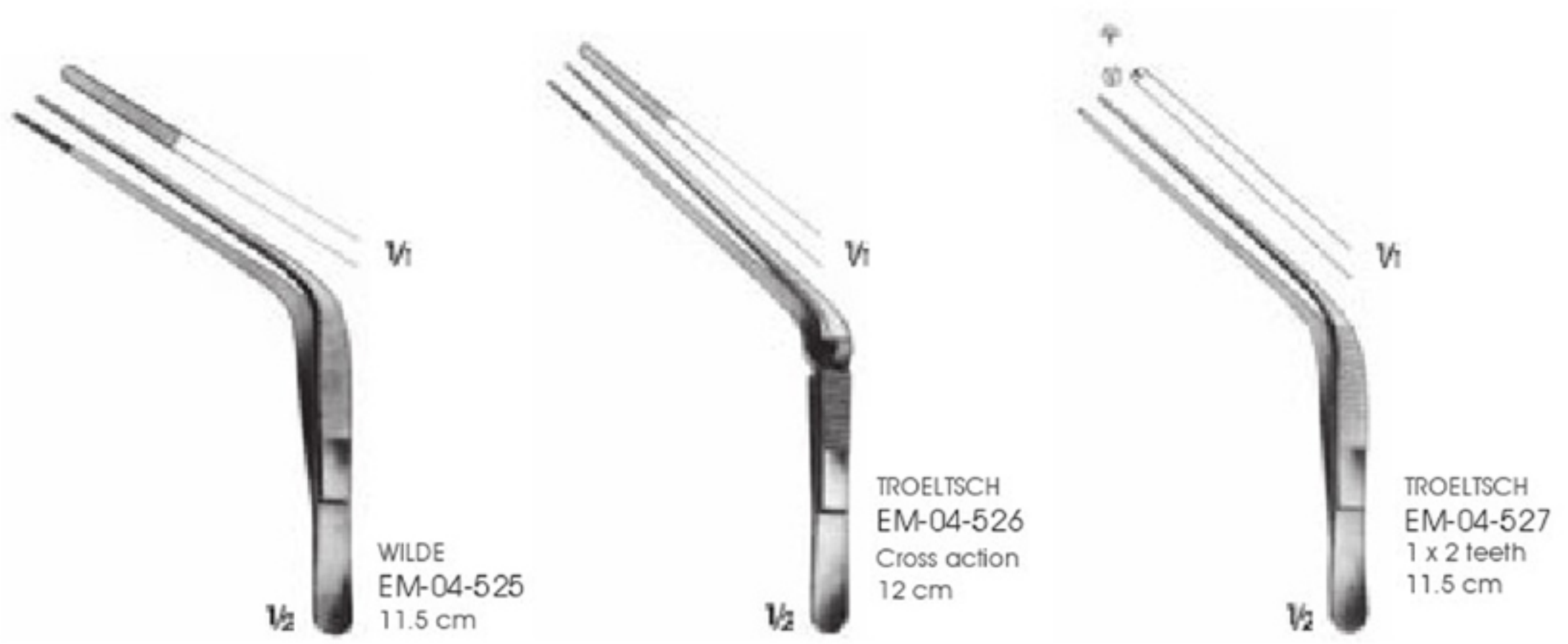
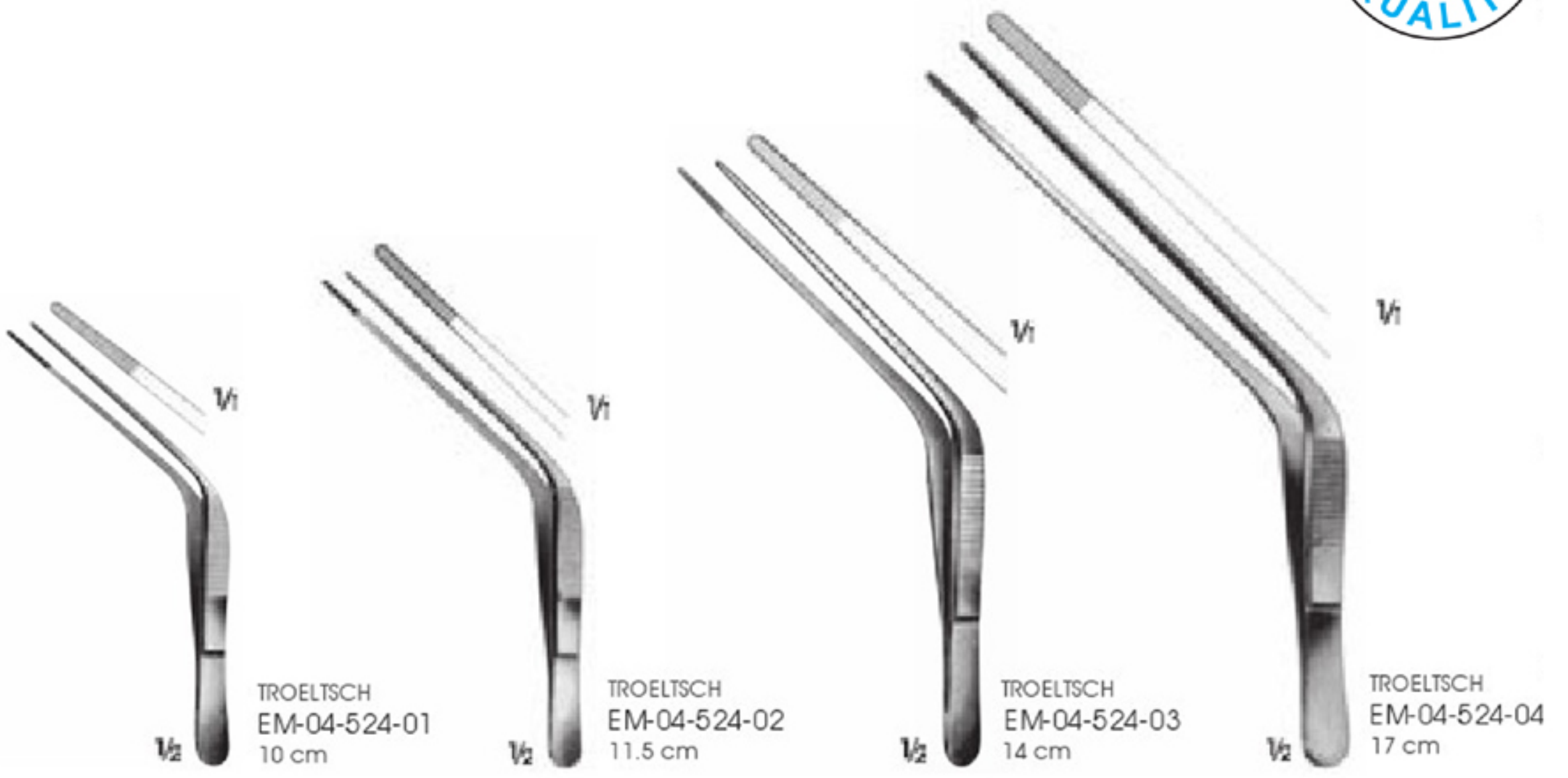

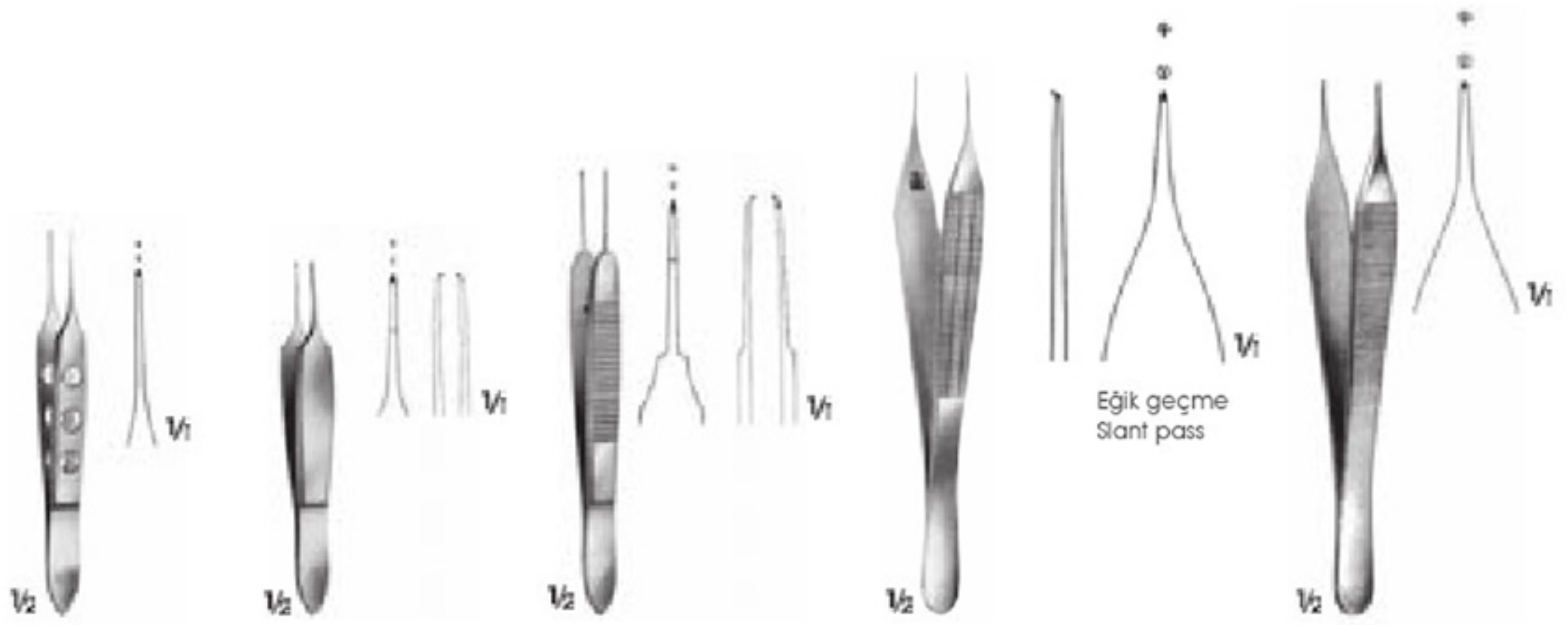

BISHOP-HARMON  
EM-04-528  
Delicate eye forceps  
8.5 cm

ST.MARTIN  
EM-04-528  
Delicate eye forceps  
8 cm

CASTROVIEJO  
EM-04-529  
Delicate eye forceps  
8 cm

MICRO-ADSON-BIEMER  
EM-04-530  
Delicate tissue forceps  
12 cm

MICRO-ADSON  
EM-04-531  
Delicate tissue forceps  
12 cm

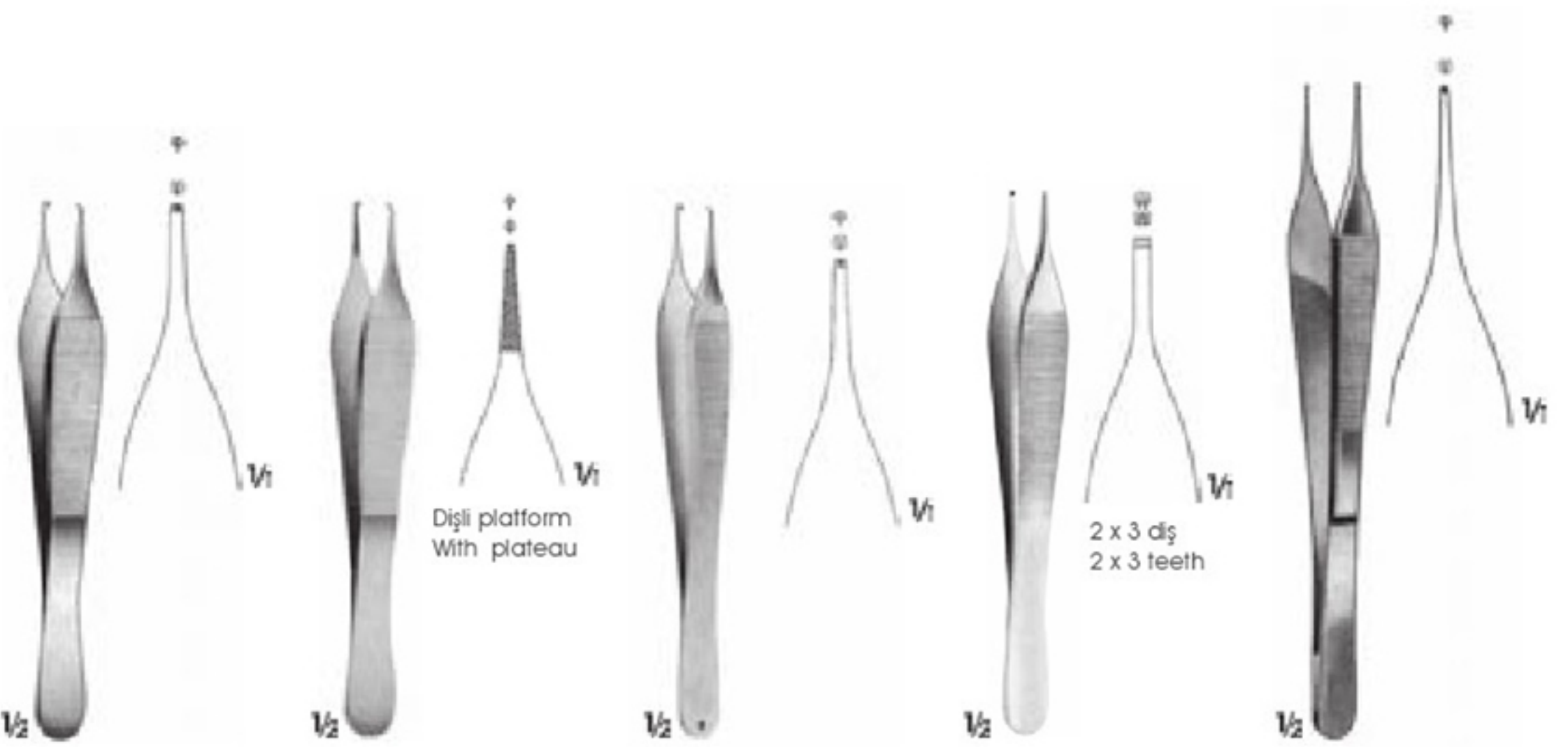

ADSON  
EM-04-532  
Delicate tissue forceps  
12 cm

ADSON  
EM-04-533  
Delicate tissue forceps  
12 cm

HUDSON  
EM-04-534  
Tissue forceps  
12.5 cm

ADSON  
EM-04-535  
Tissue forceps  
12 cm

MICRO-ADSON  
EM-04-536  
Delicate tissue forceps  
15 cm

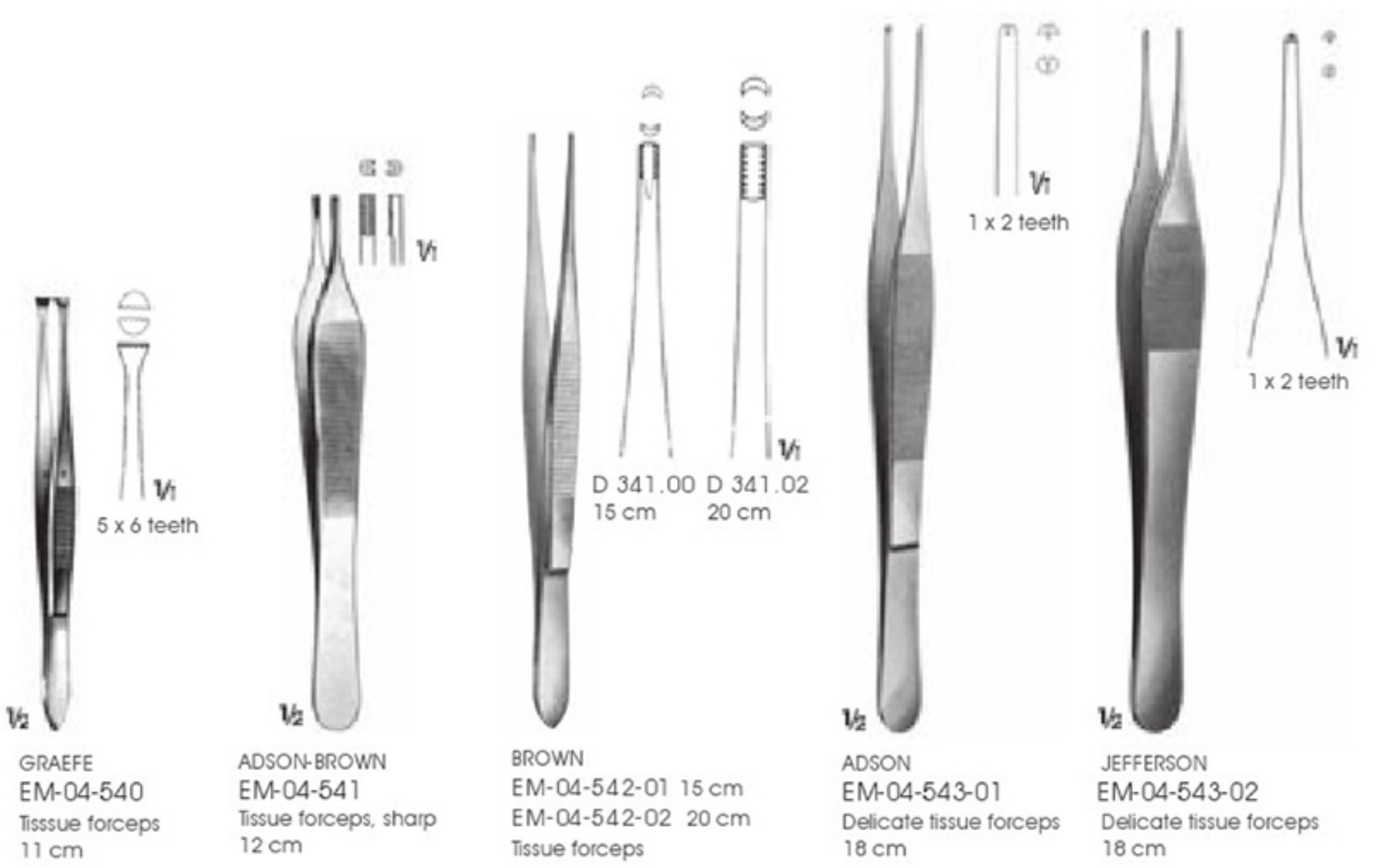
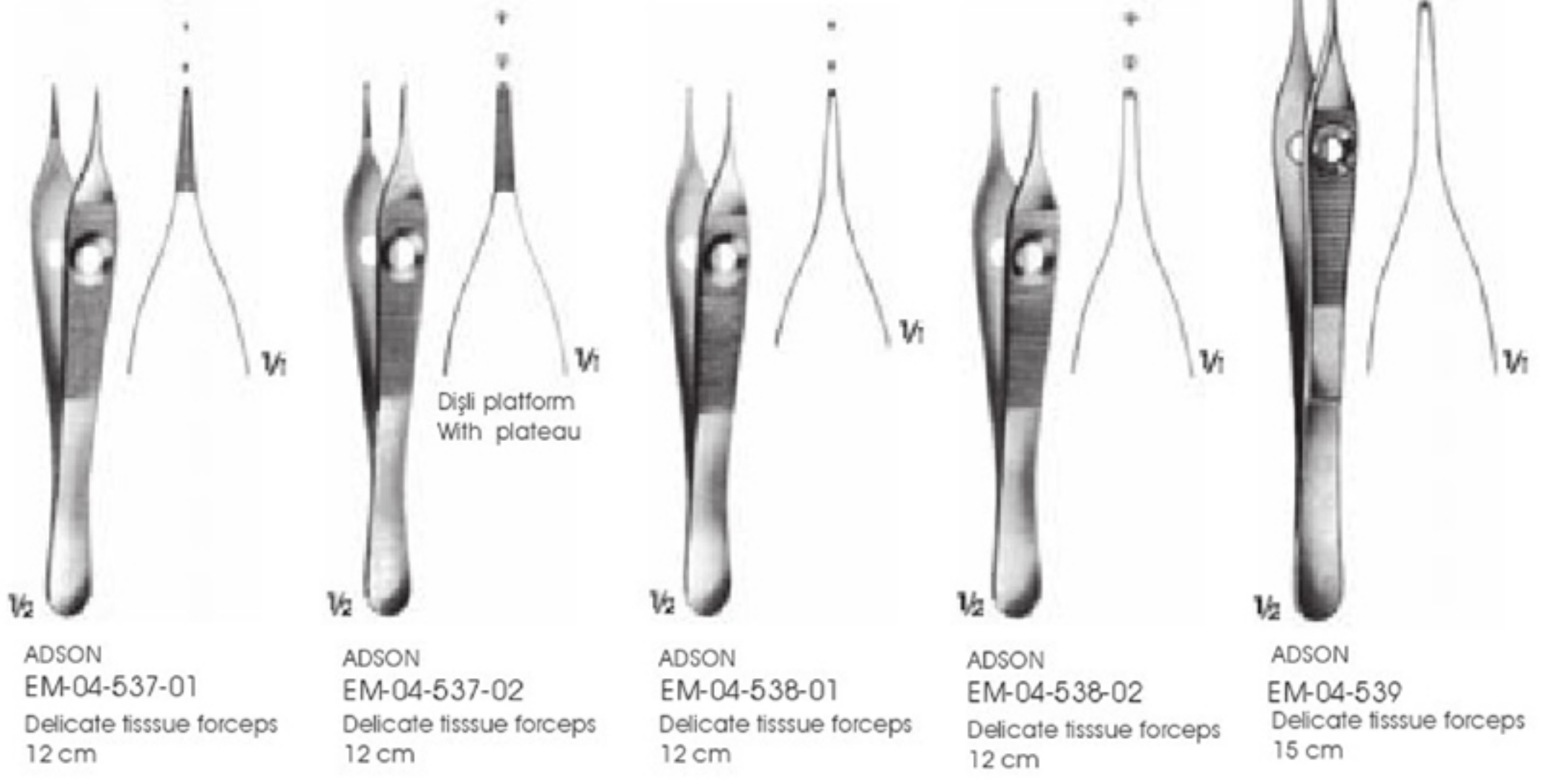



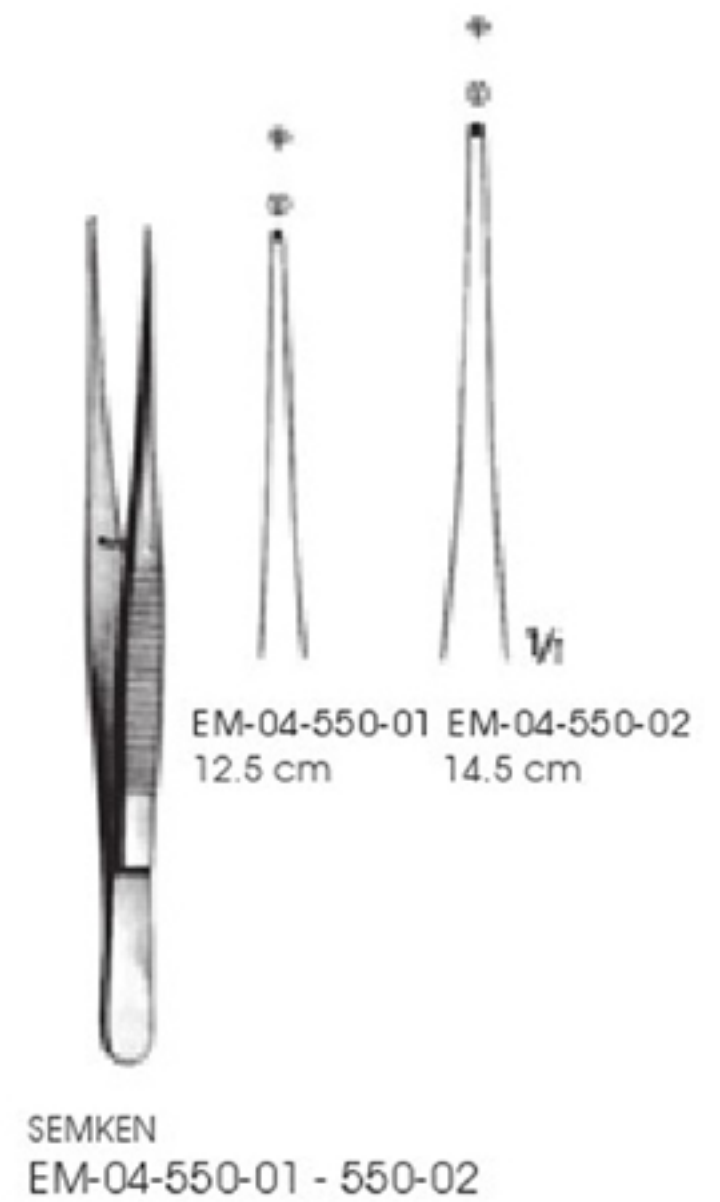
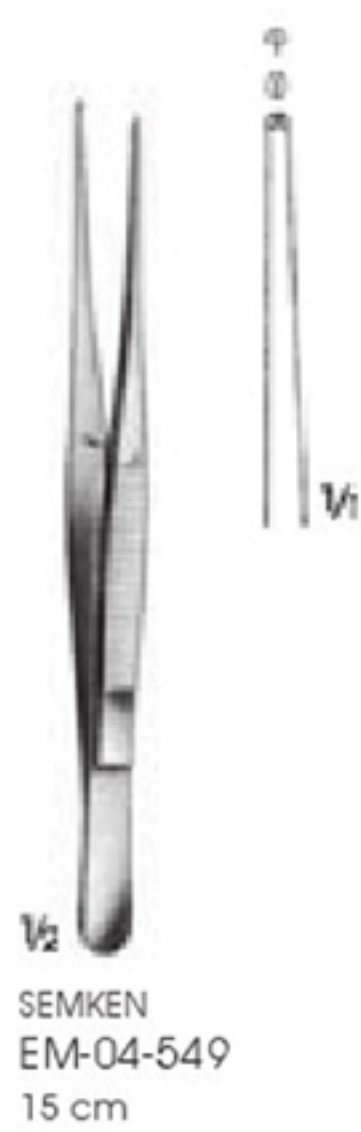
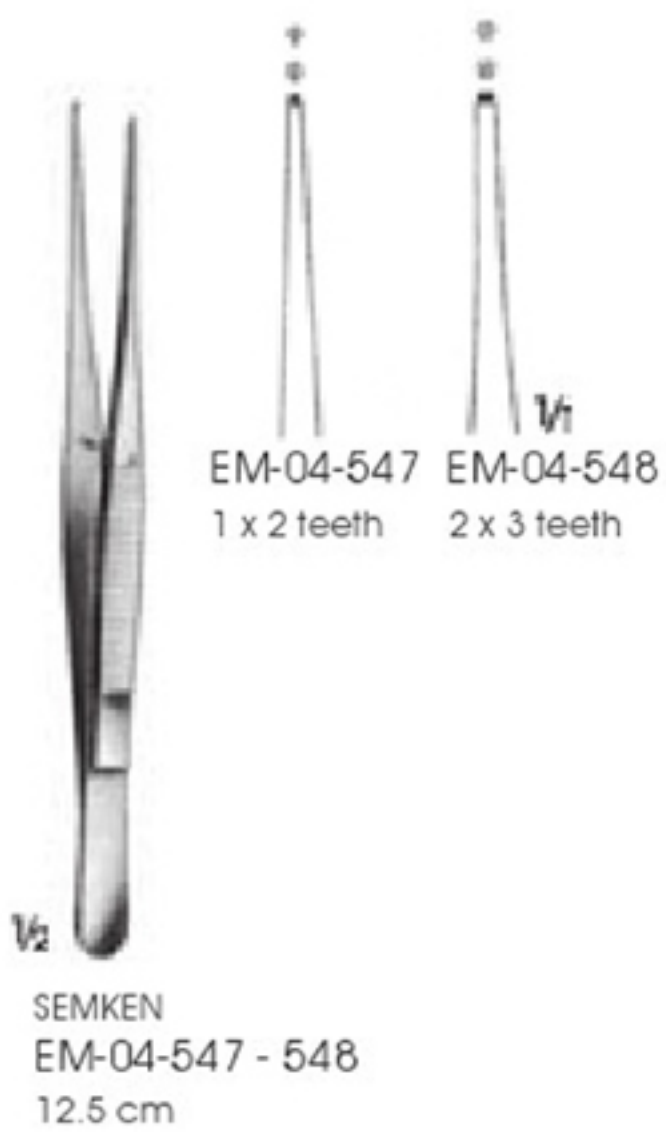
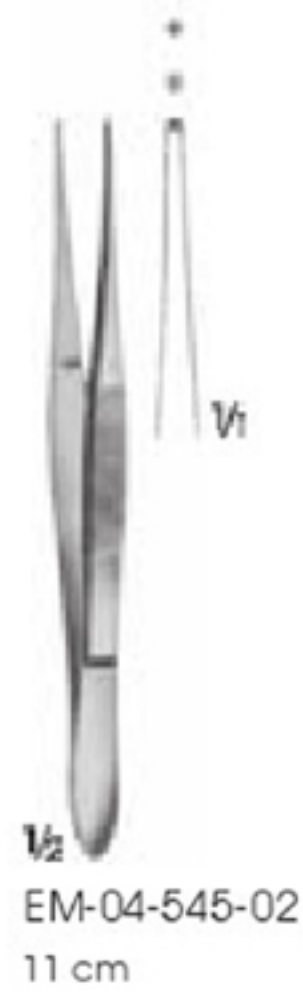
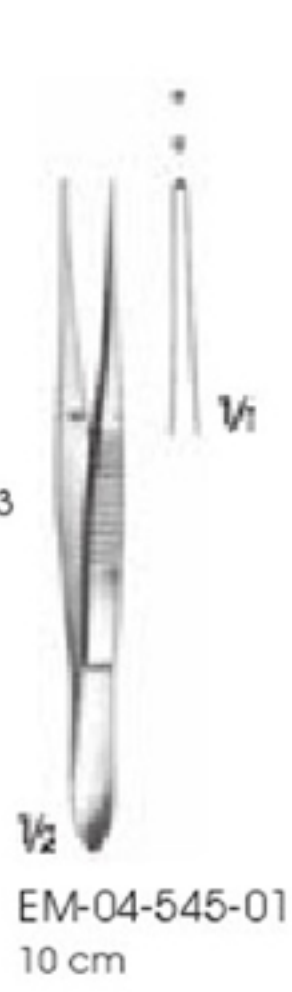
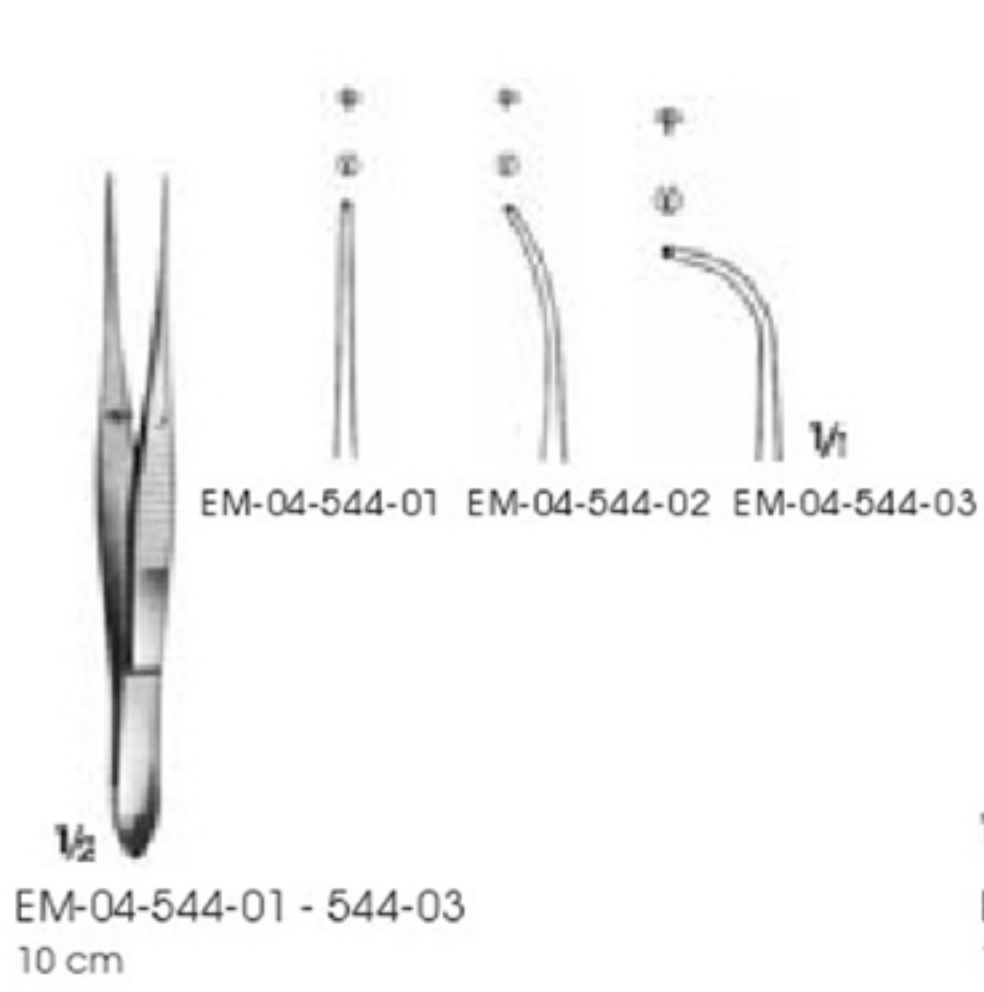



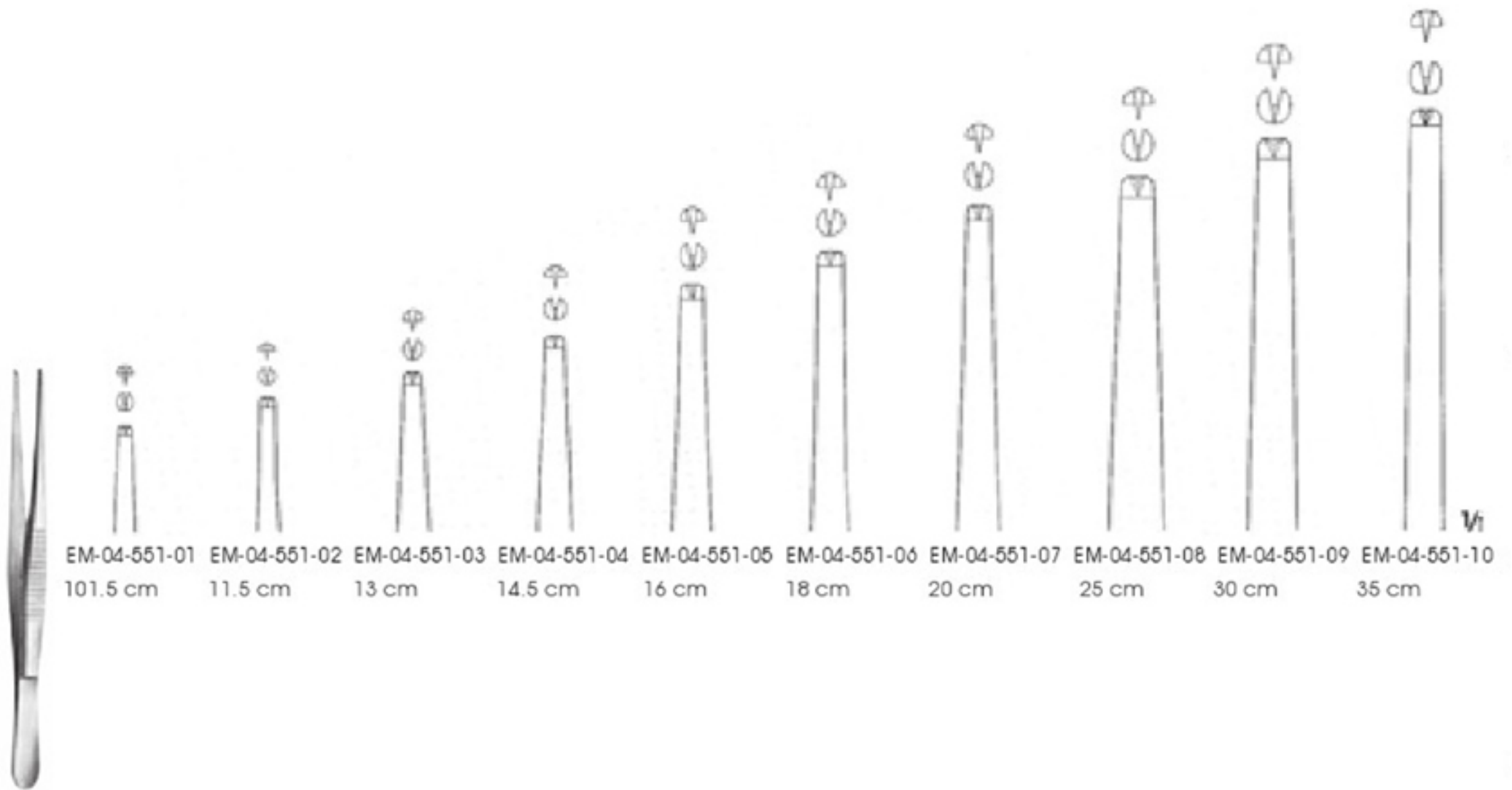

EM-04-551-01 - 551-10  
Standard modelle

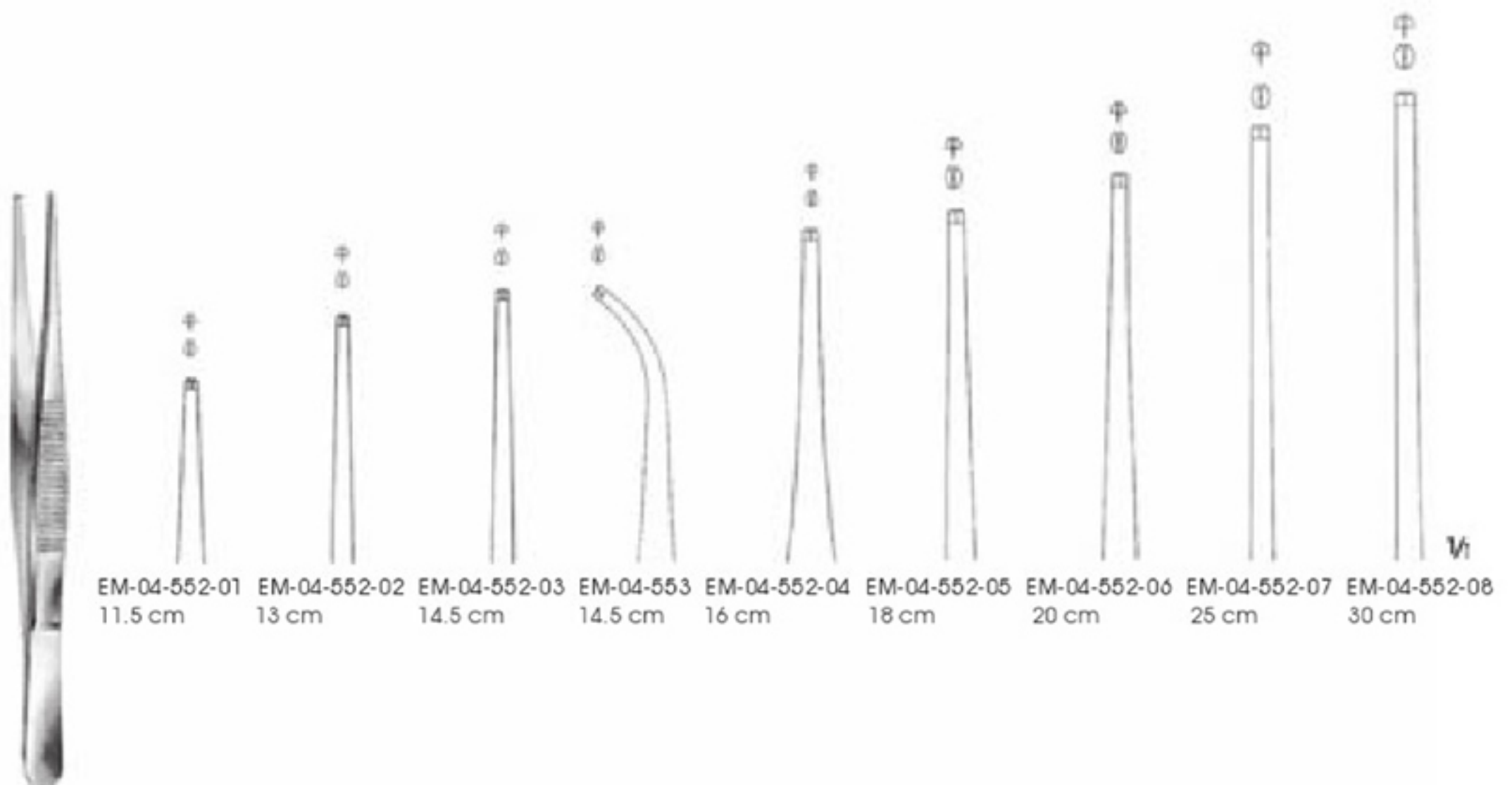

EM-04-552-01 - 553  
medium

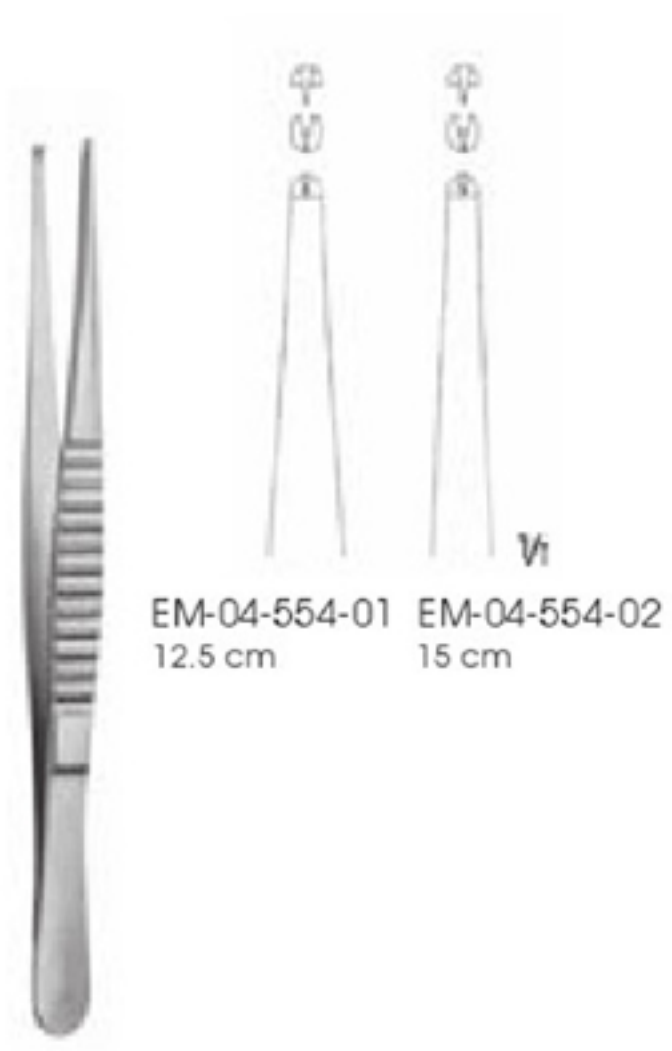

EM-04-554-01 12.5 cm  
EM-04-554-02 15 cm

TREVES  
EM-04-554-01 - 554-02  
Tissue forceps

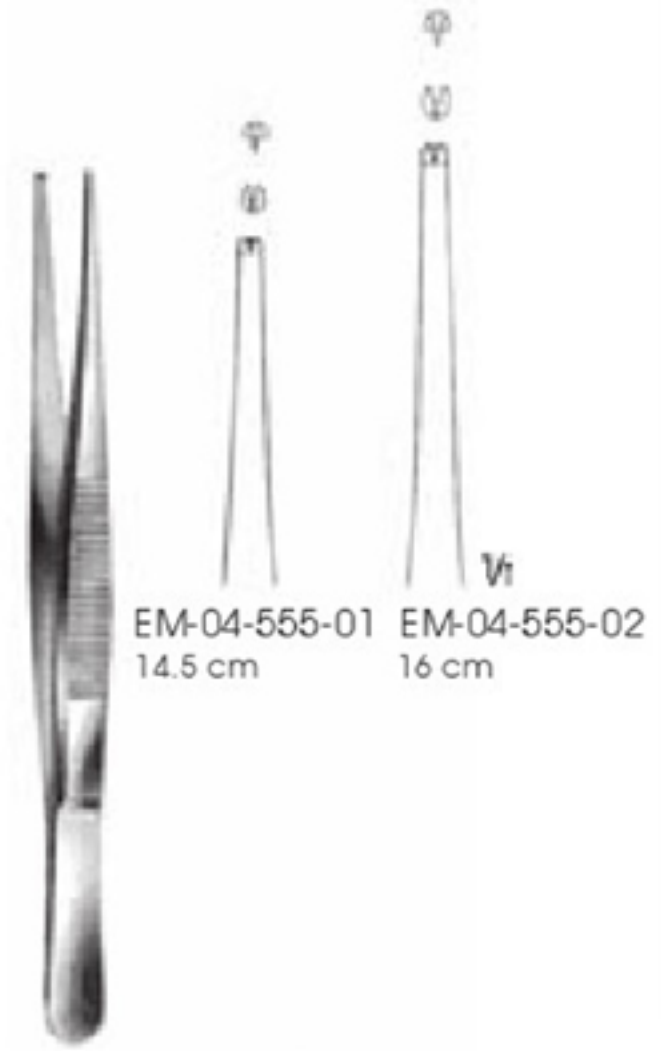

EM-04-555-01 14.5 cm  
EM-04-555-02 16 cm

EM-04-555-01 - 555-02  
Tissue forceps

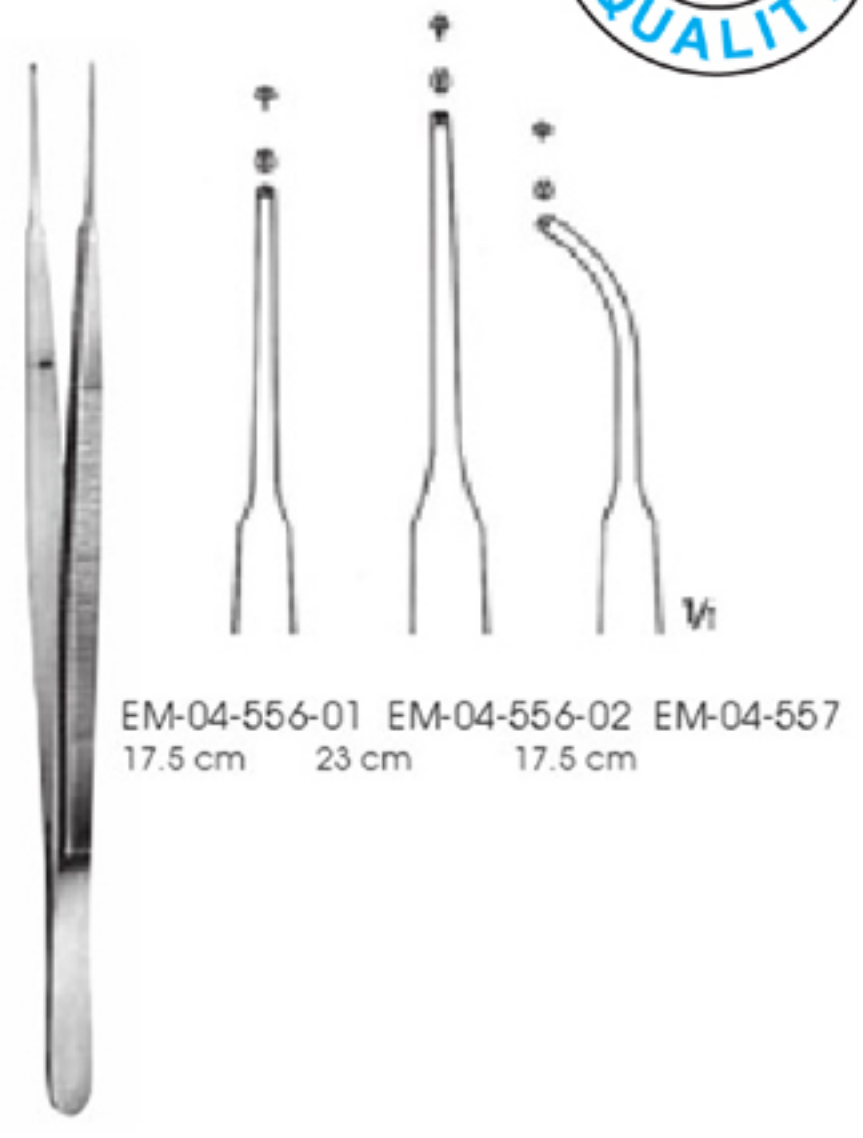

EM-04-556-01 17.5 cm  
EM-04-556-02 23 cm  
EM-04-557 17.5 cm

GERALD  
EM-04-556-01 - 557  
Delicate tissue forceps



EM-04-558  
Doku penset  
Tissue forceps  
20 cm

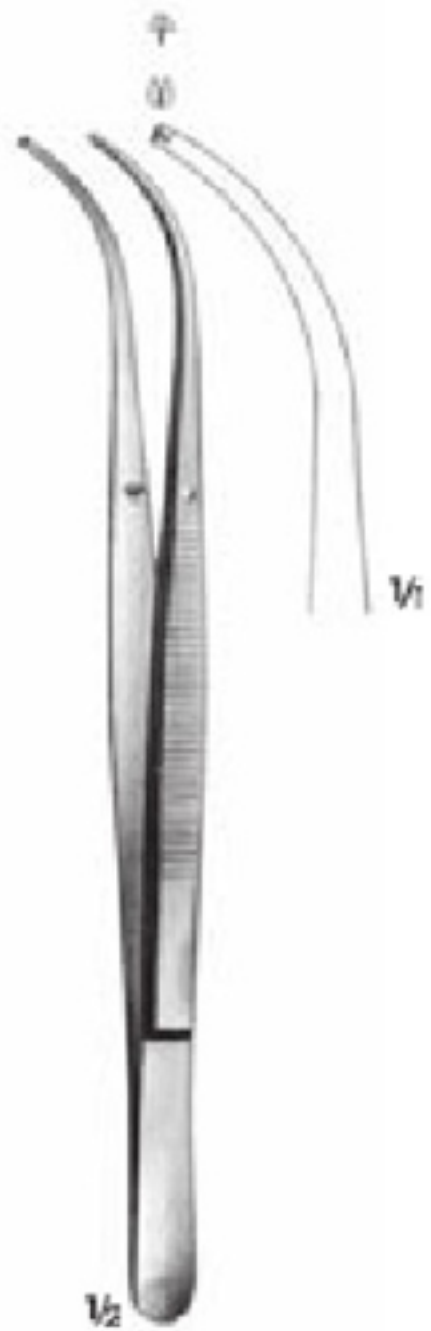

BROPHY  
EM-04-559  
Doku penset  
Tissue forceps  
20 cm



CUSHING  
EM-04-560  
Doku penset  
Tissue forceps  
18 cm



EM-04-561-01 15 cm  
EM-04-561-02 20 cm

STRASSBURGER MODEL  
EM-04-561-01 - 561-02  
Doku pensetleri  
Tissue forceps

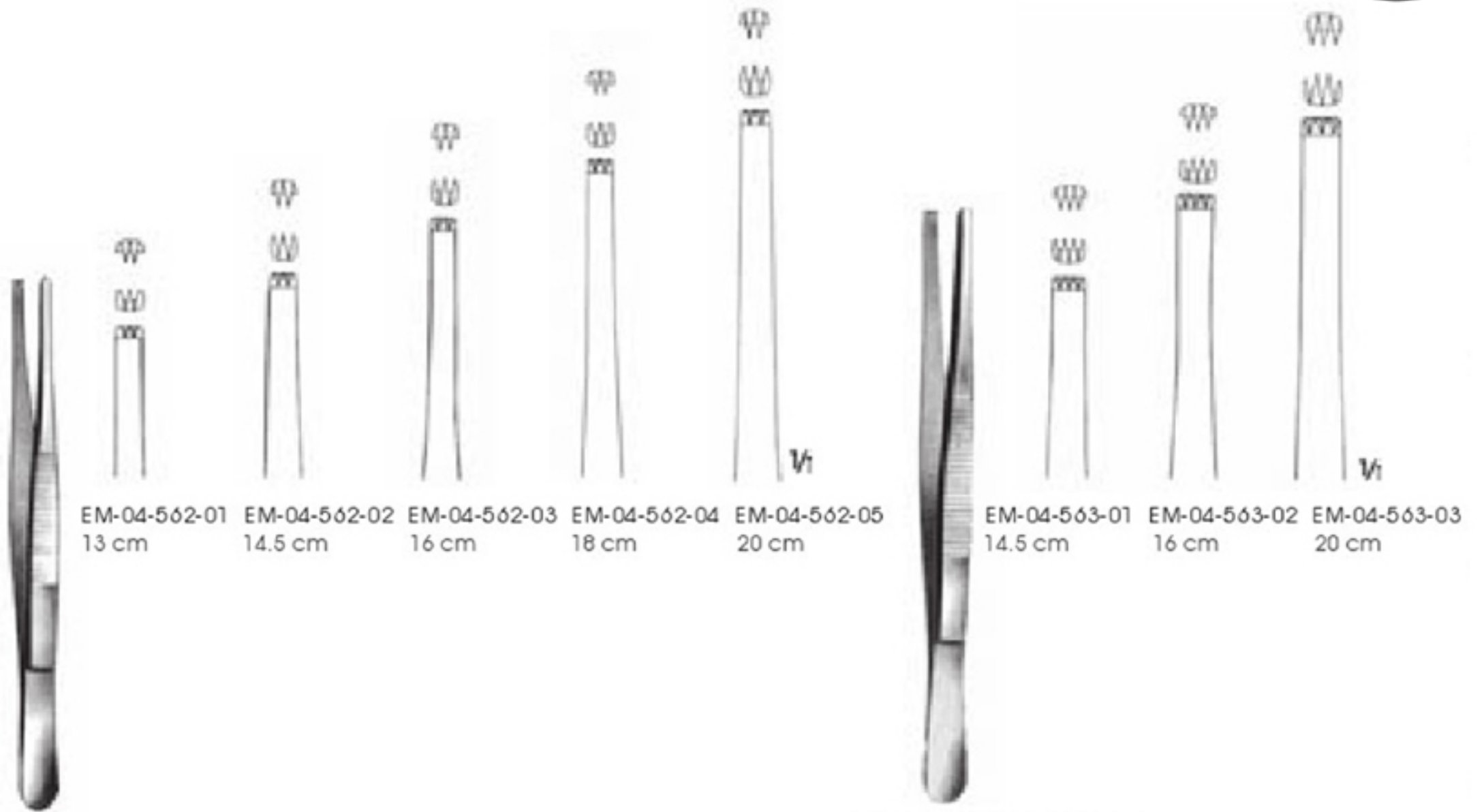

EM-04-562-01 - 562-05  
2 x 3 teeth

EM-04-563-01 - 563-03  
3 x 4 teeth

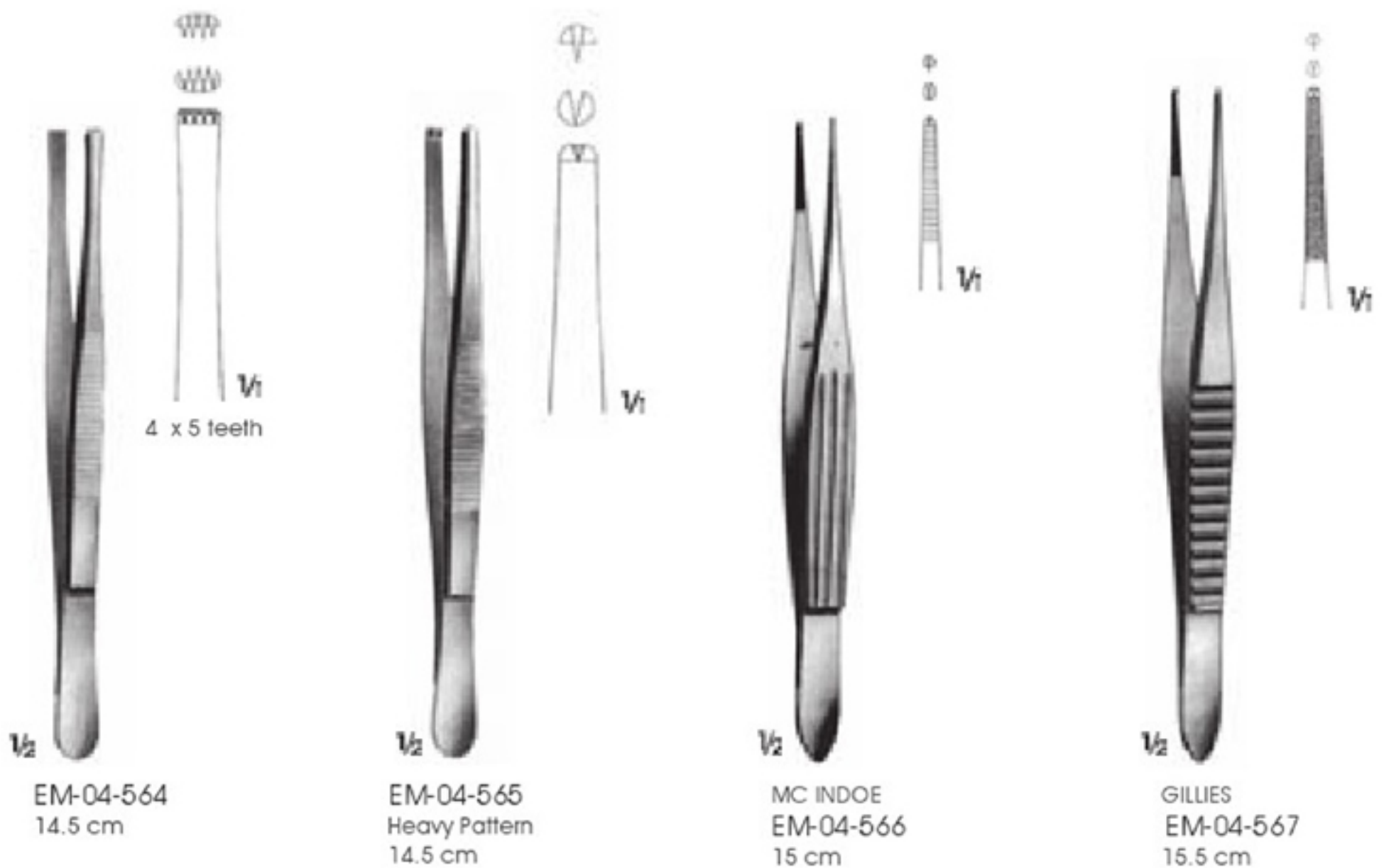

EM-04-564  
14.5 cm

EM-04-565  
Heavy Pattern  
14.5 cm

MC INDOE  
EM-04-566  
15 cm

GILLIES  
EM-04-567  
15.5 cm



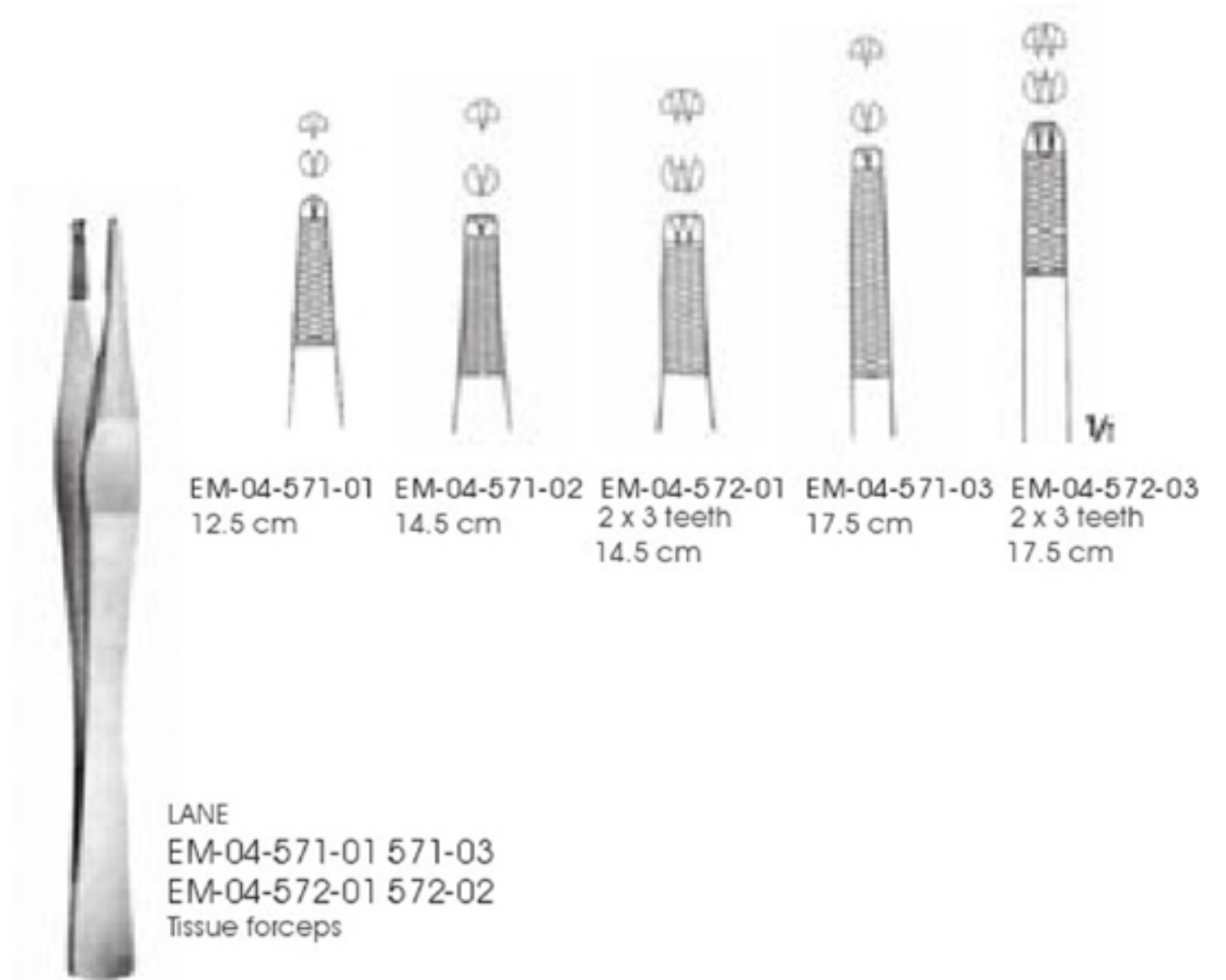
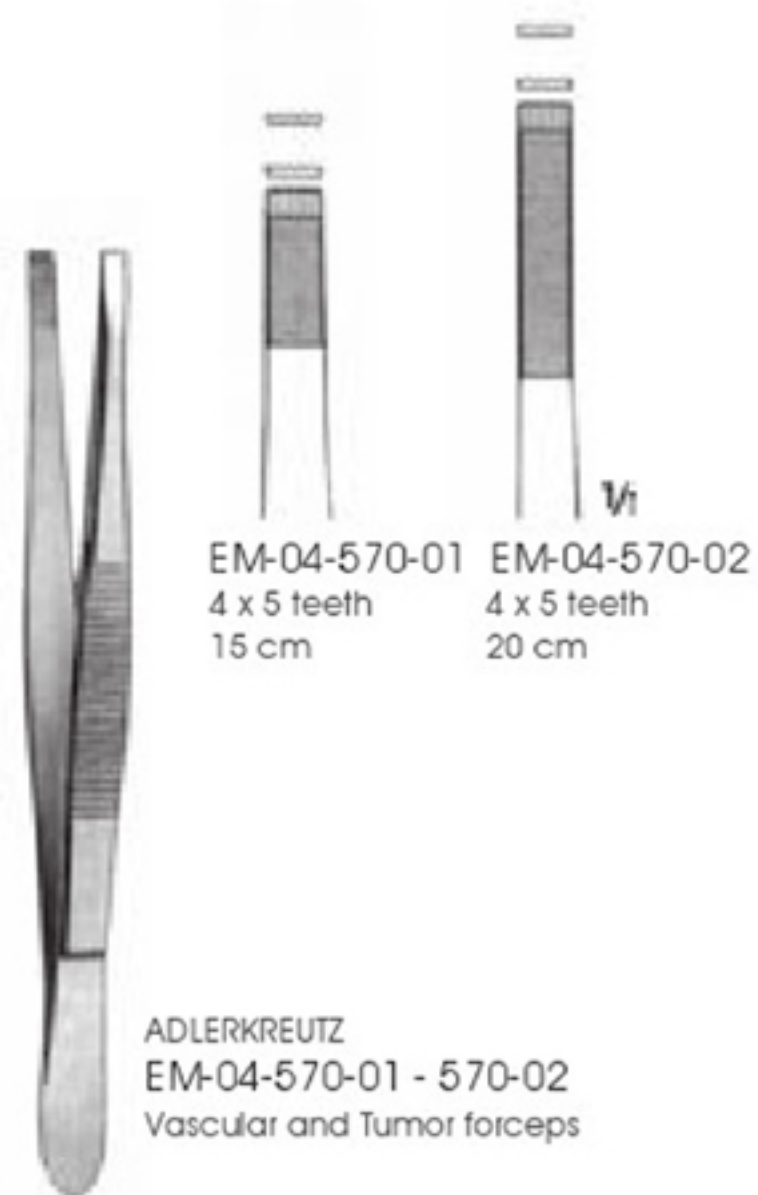
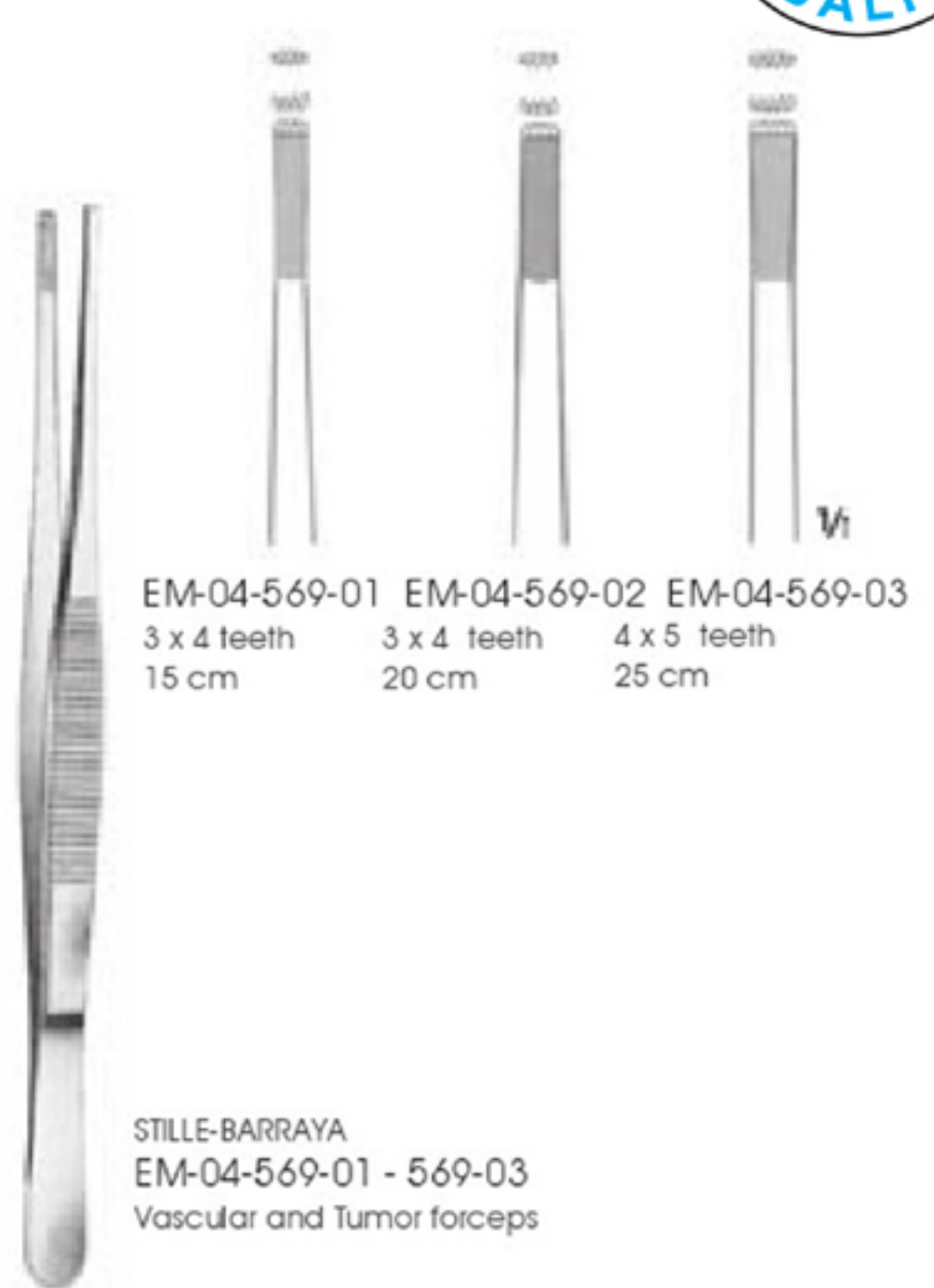
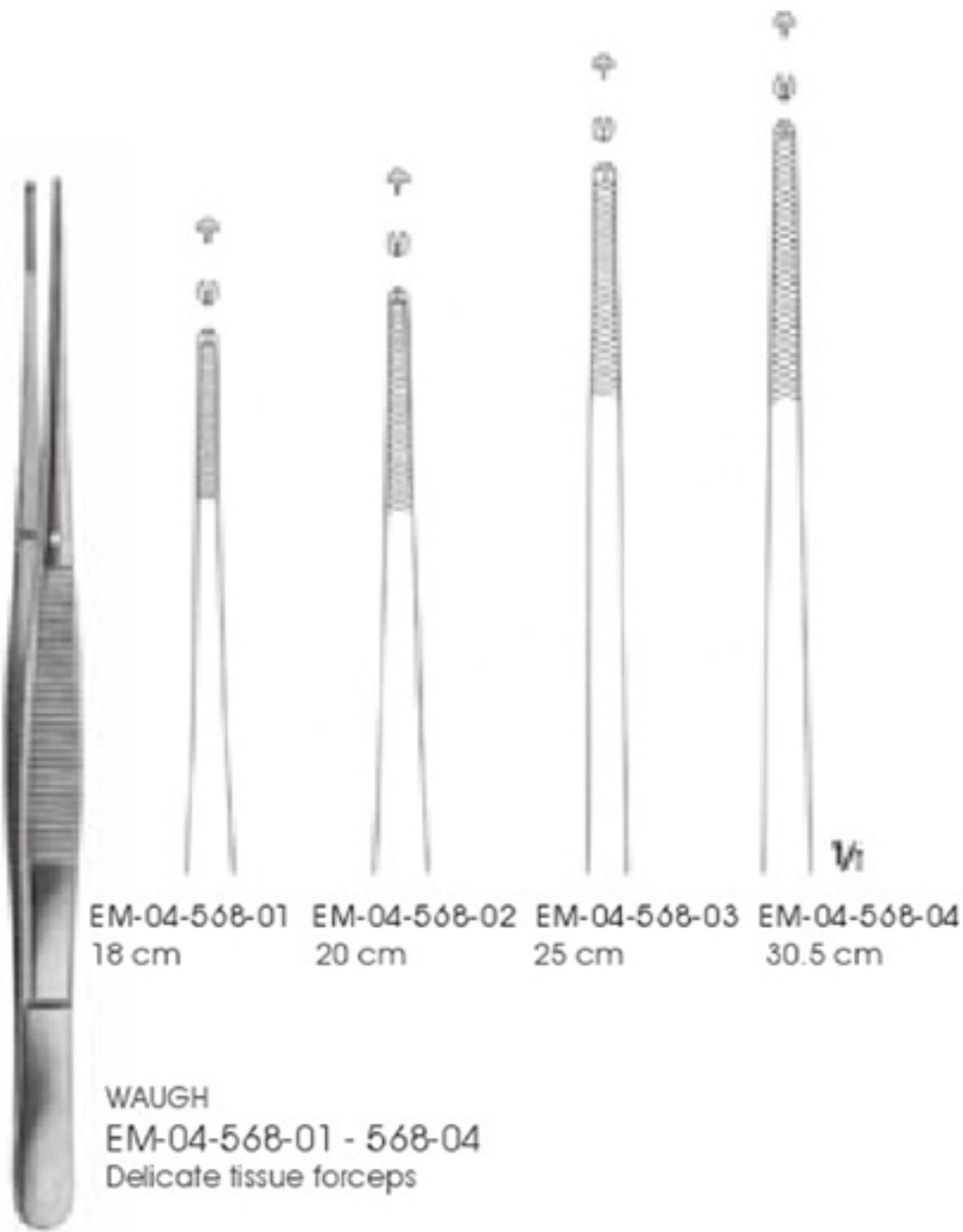



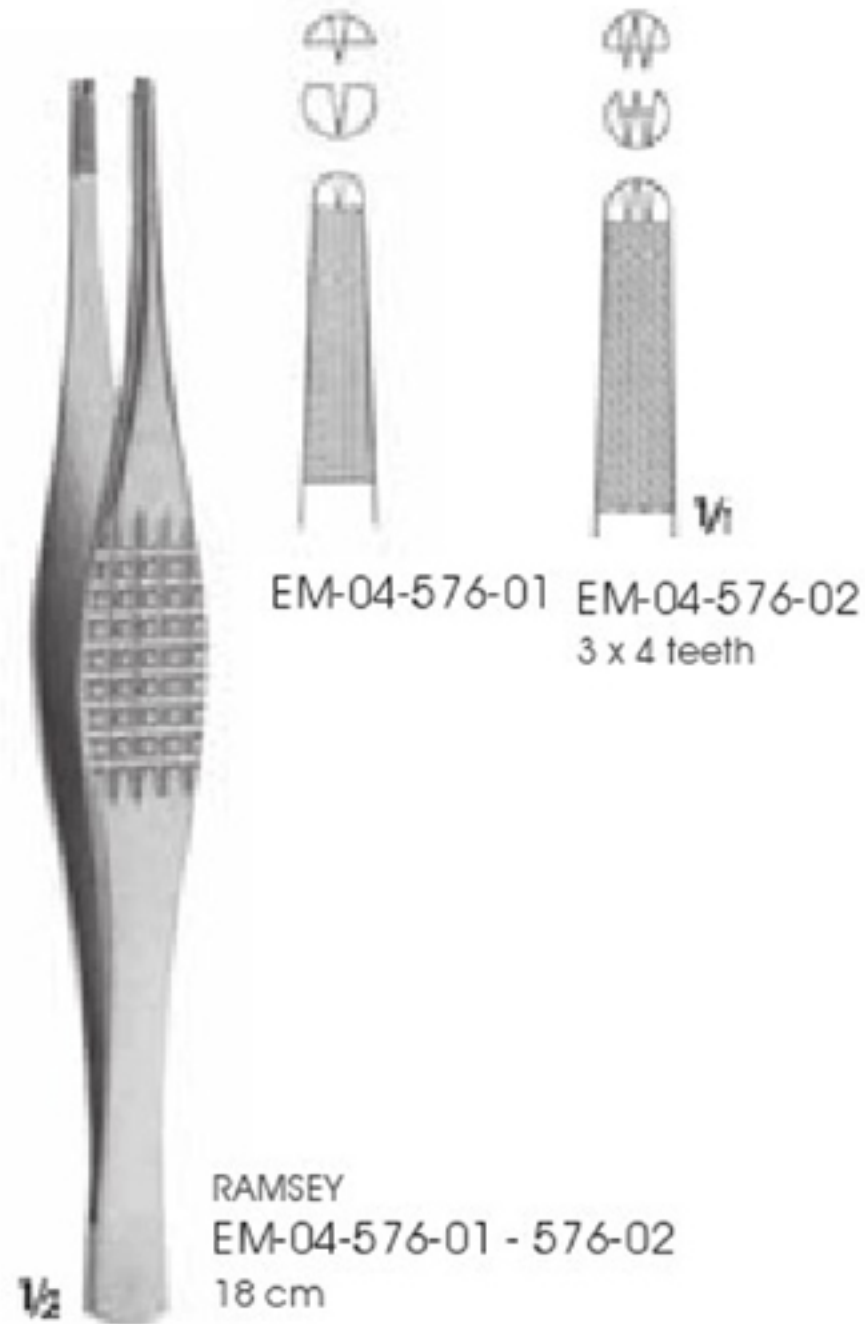
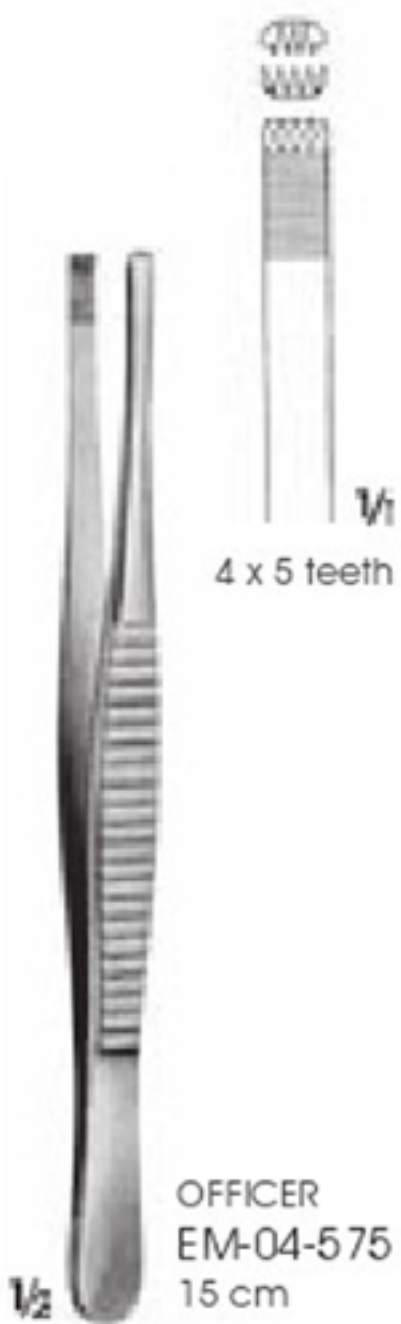
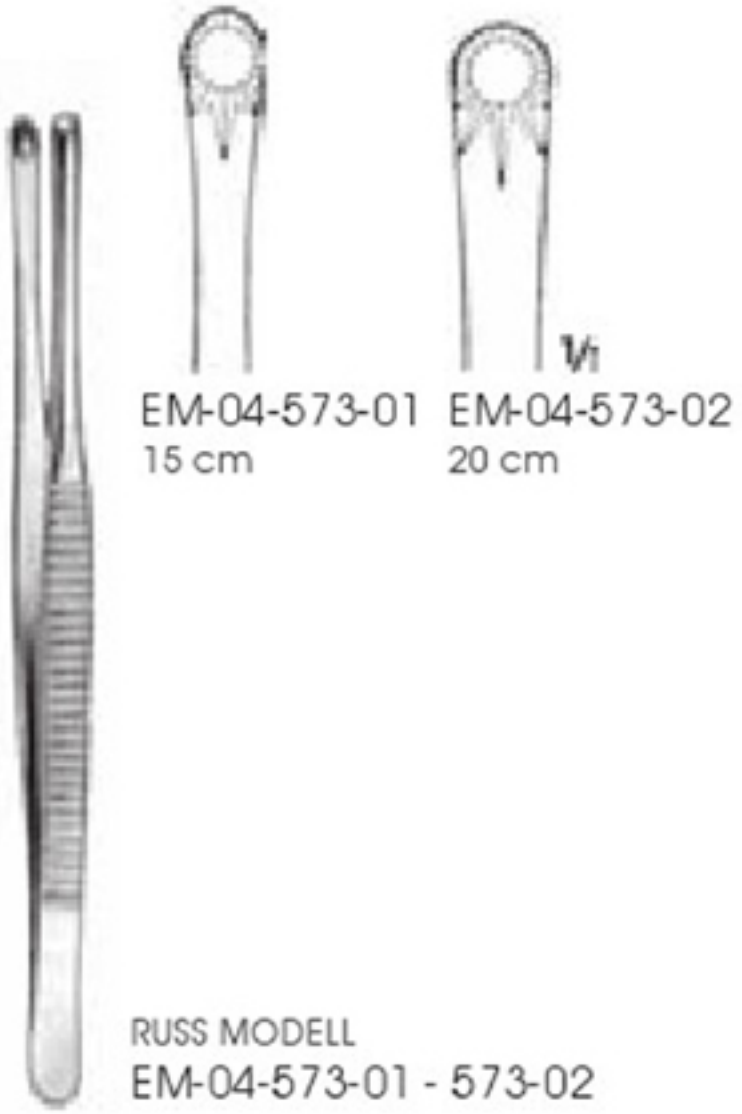

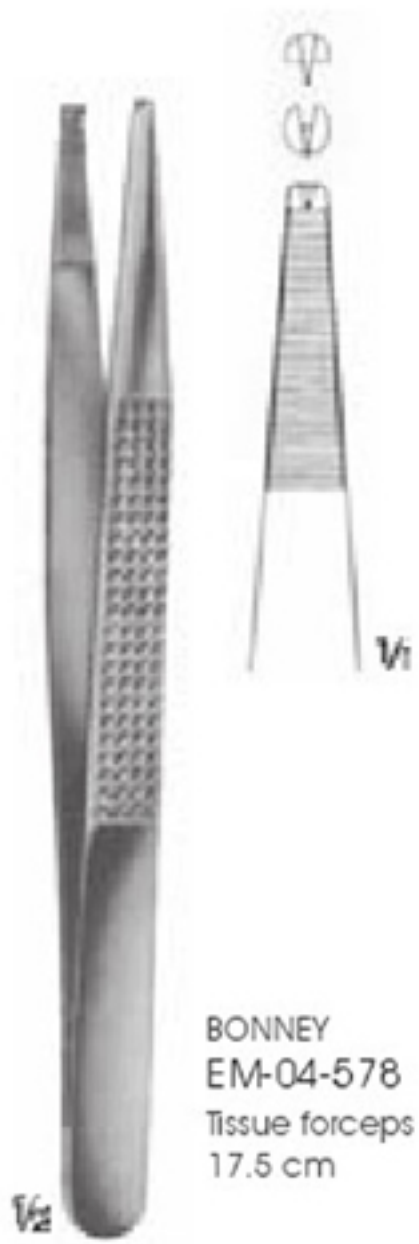

BONNEY  
 EM-04-578  
 Tissue forceps  
 17.5 cm

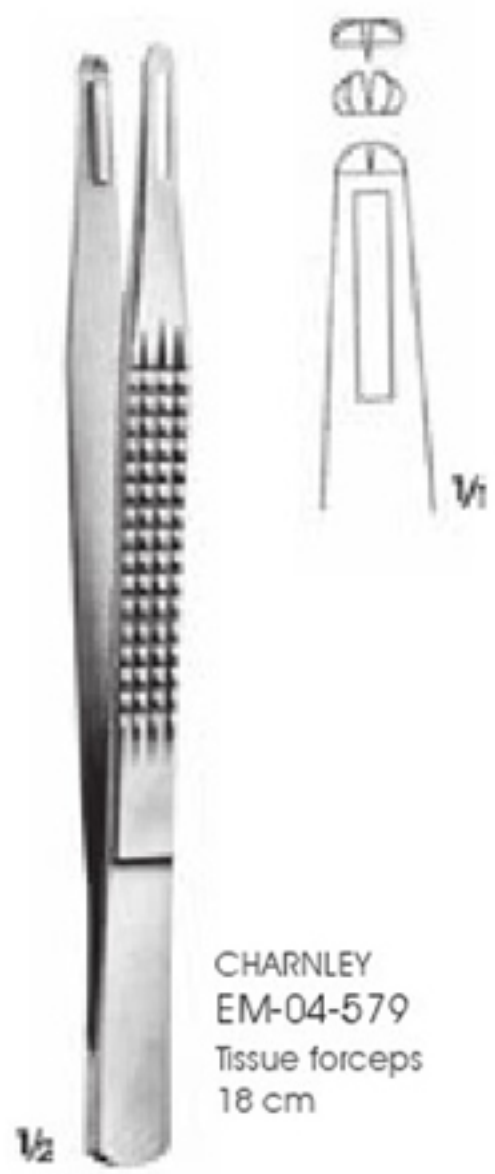

CHARNLEY  
 EM-04-579  
 Tissue forceps  
 18 cm

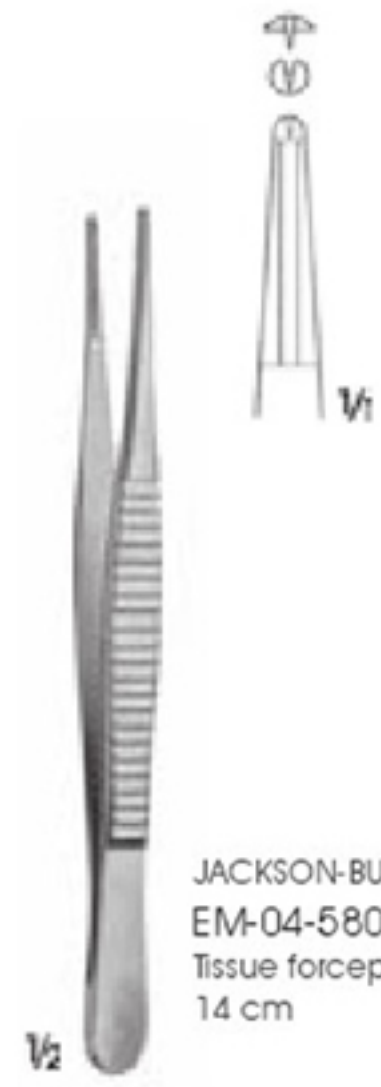

JACKSON-BURROWS  
 EM-04-580  
 Tissue forceps  
 14 cm



DUVAL  
 EM-04-581  
 Intestinal forceps  
 14 cm



DENNIS-BROWNE  
 EM-04-582  
 Intestinal forceps  
 19 cm

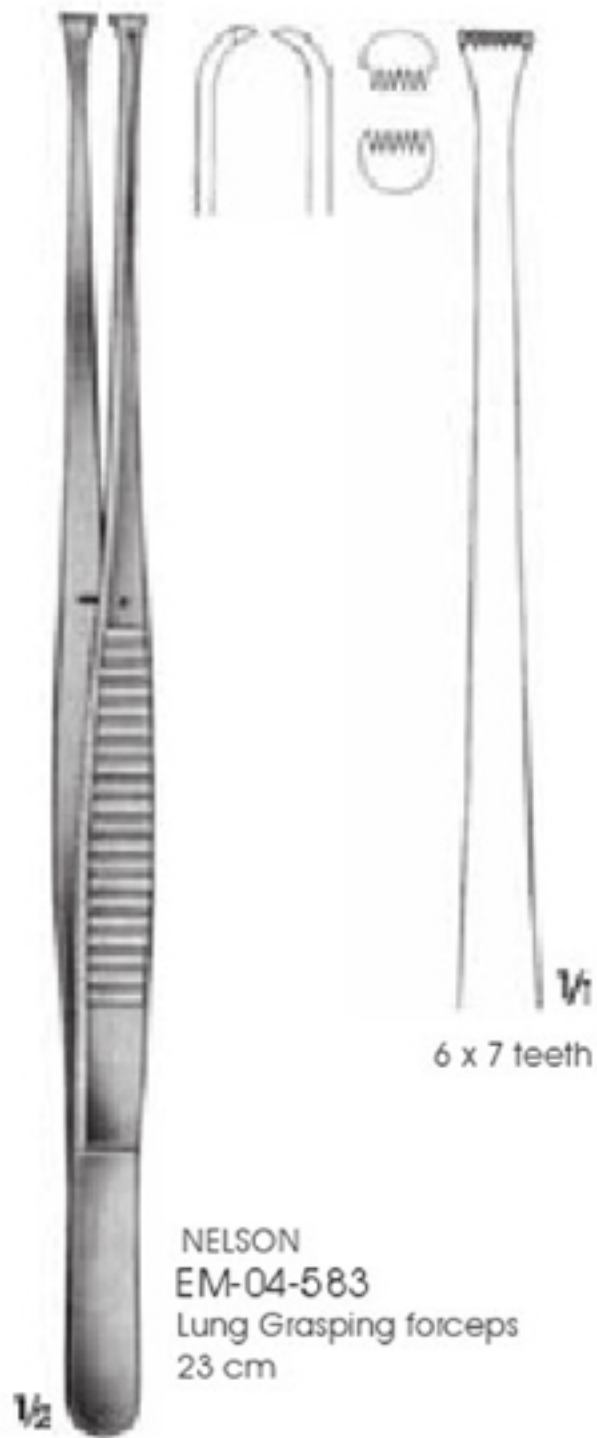

NELSON  
 EM-04-583  
 Lung Grasping forceps  
 23 cm

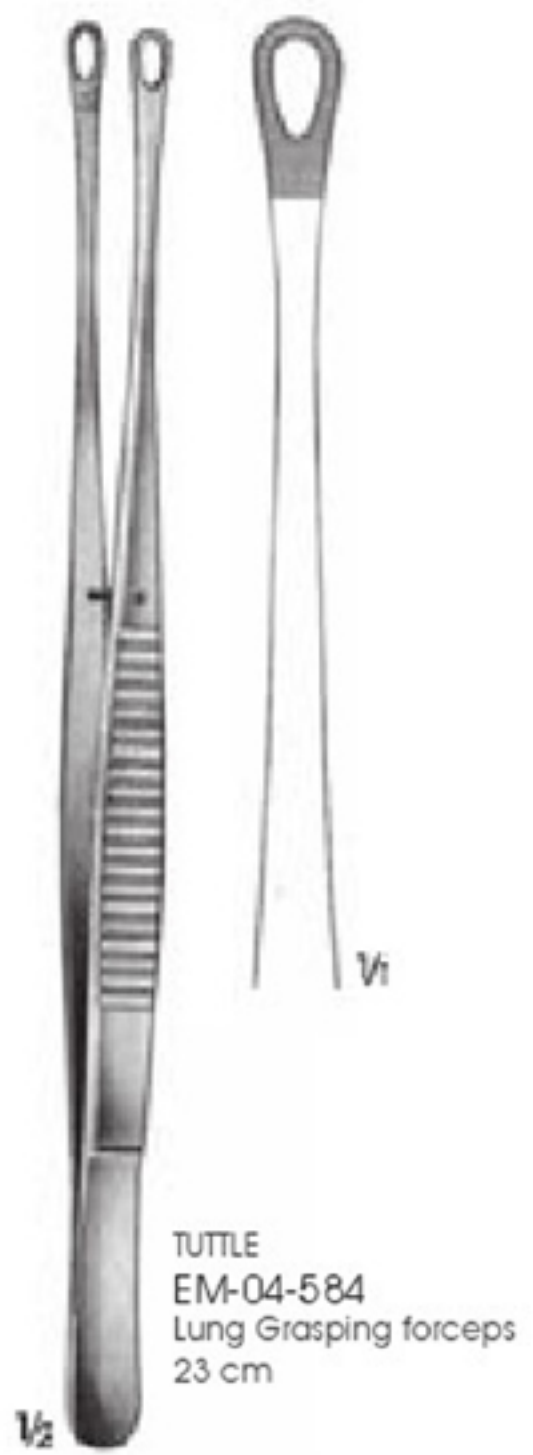

TUTTLE  
 EM-04-584  
 Lung Grasping forceps  
 23 cm



EM-04-585  
Splinter forceps  
8 cm

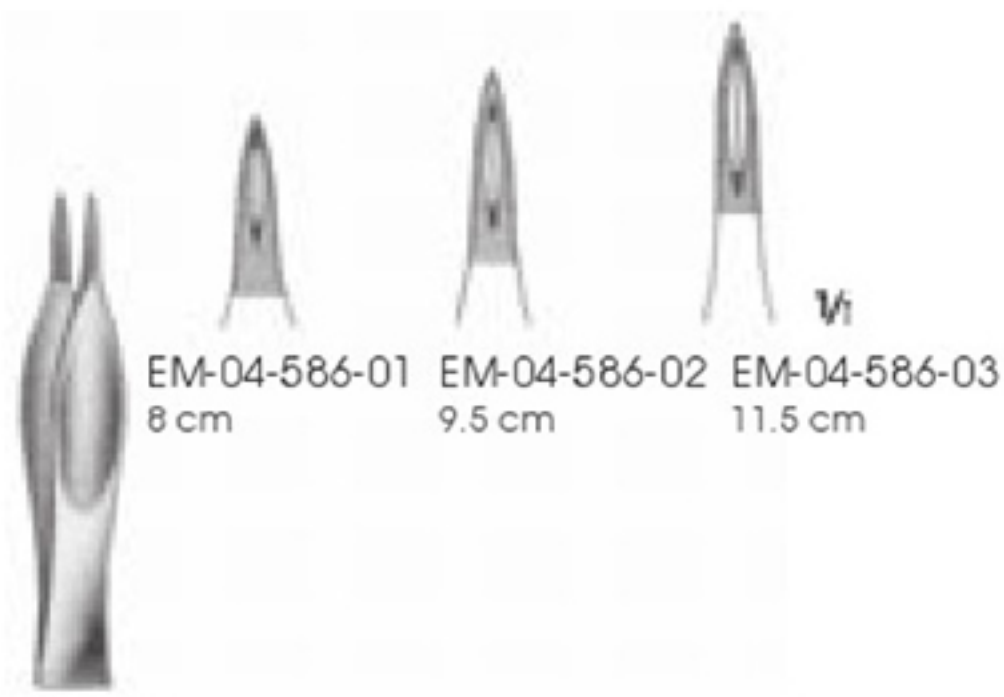

FEILCHENFELD  
EM-04-586-01 - 586-03  
Splinter forceps

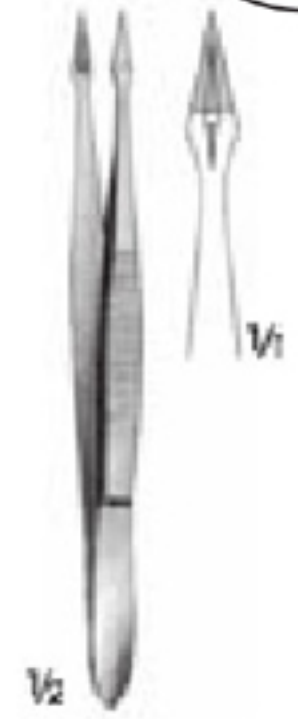

HUNTER  
EM-04-587  
Splinter forceps  
10.5 cm

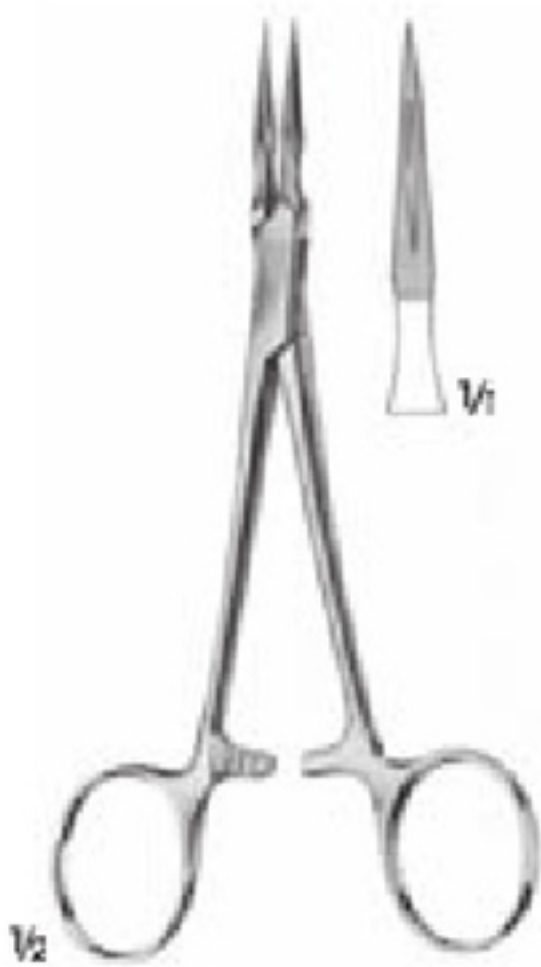

STIEGLITZ  
EM-04-588  
Splinter forceps  
14 cm

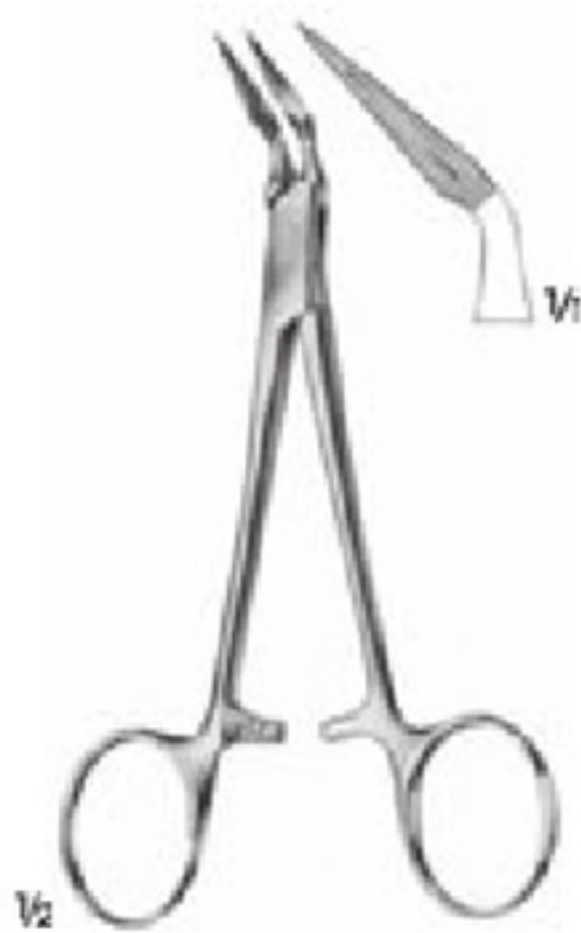

STIEGLITZ  
EM-04-589  
Splinter forceps  
14 cm



STIEGLITZ  
EM-04-590  
Splinter forceps  
12 cm



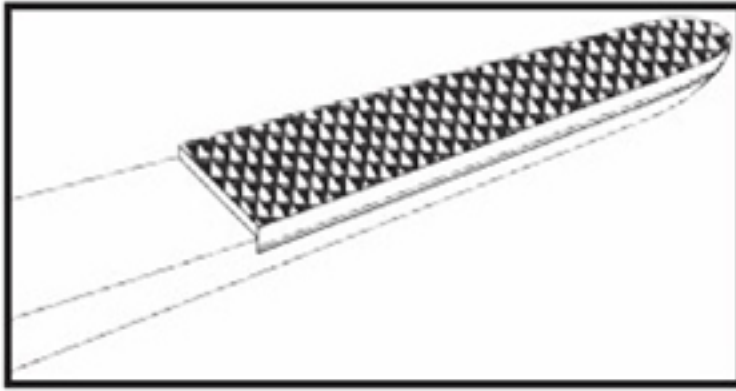

Carbide-tipped dissecting forceps

- Due-to slender carbide tip, efficient use
- Tight gripping without damaging the tissue
- Multi-purpose use
- Long working life

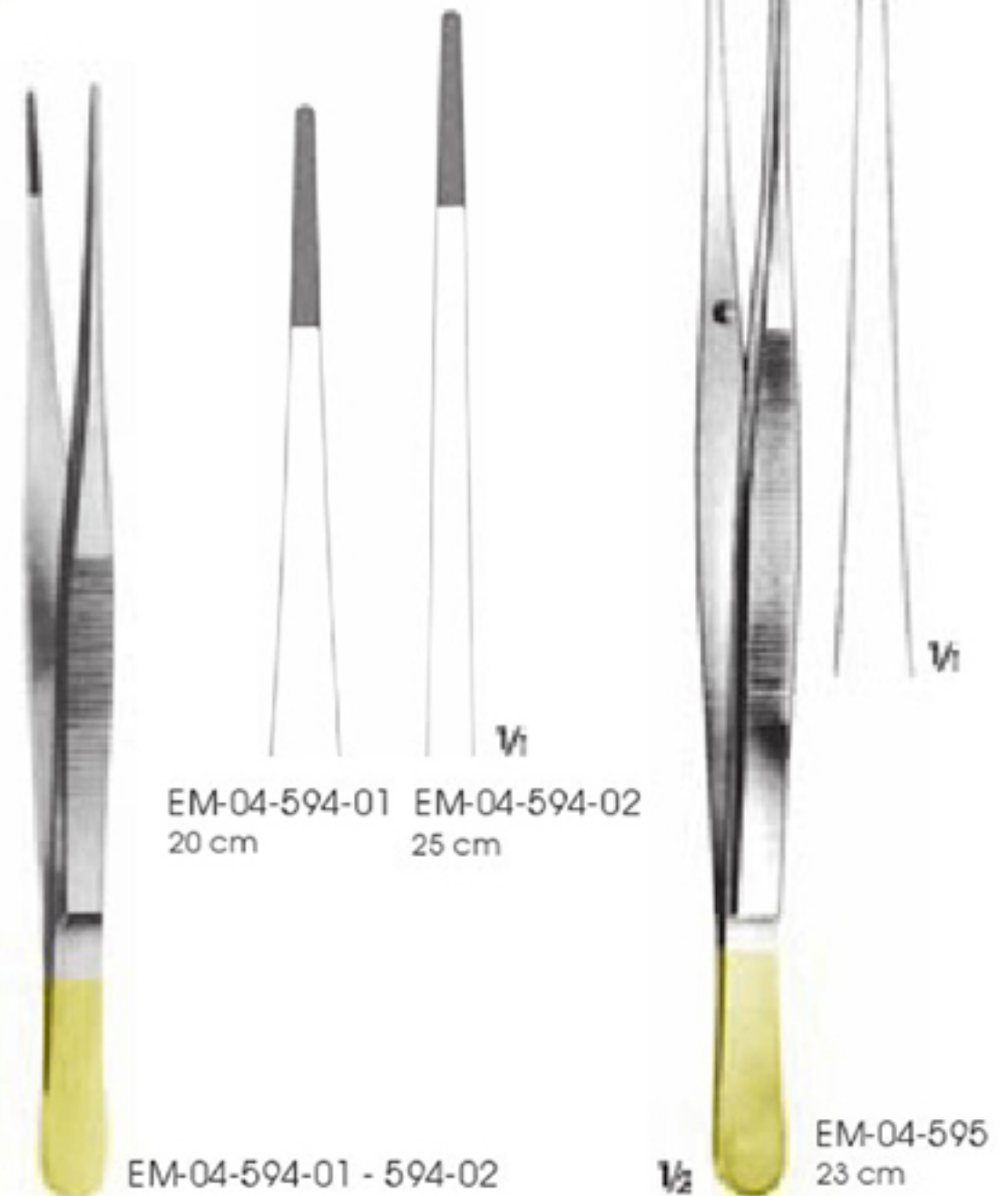
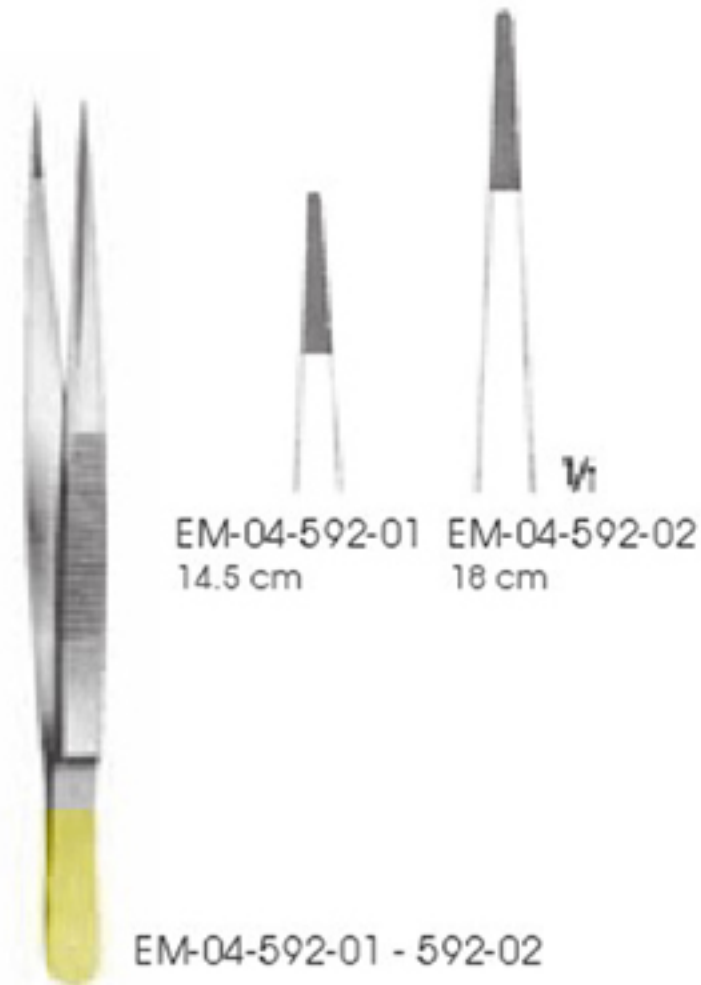



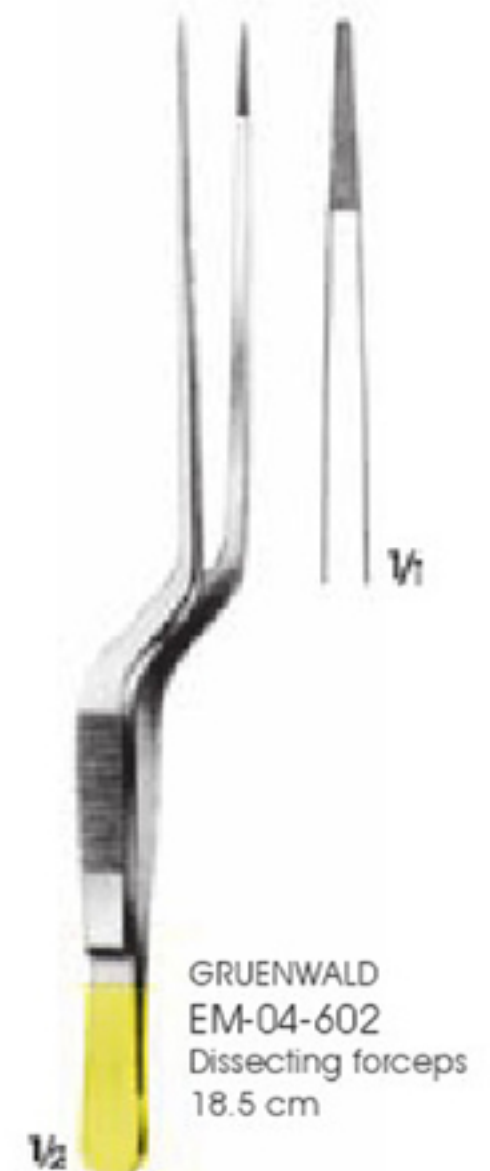
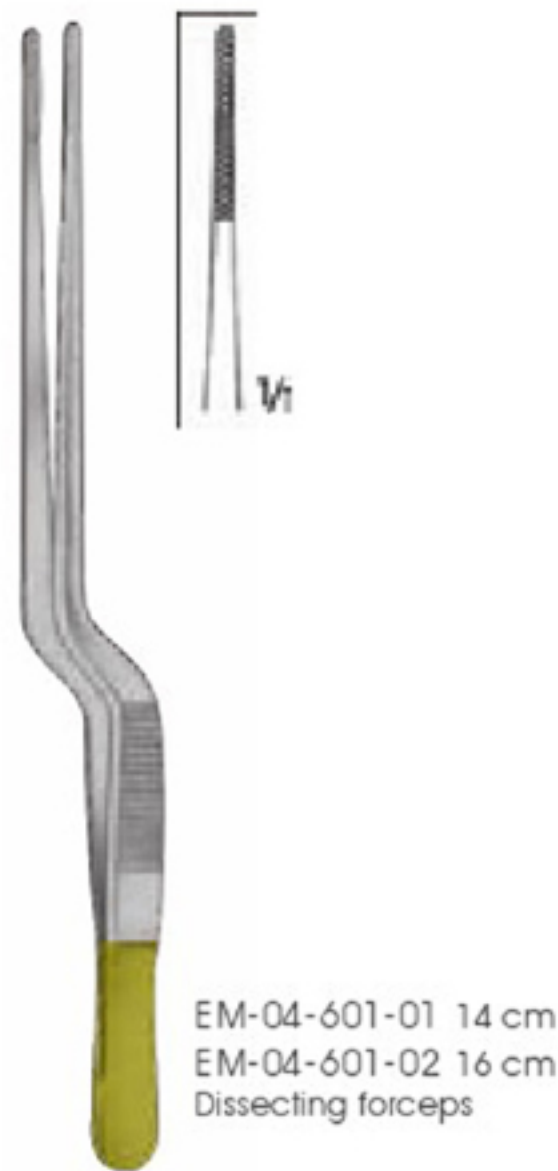
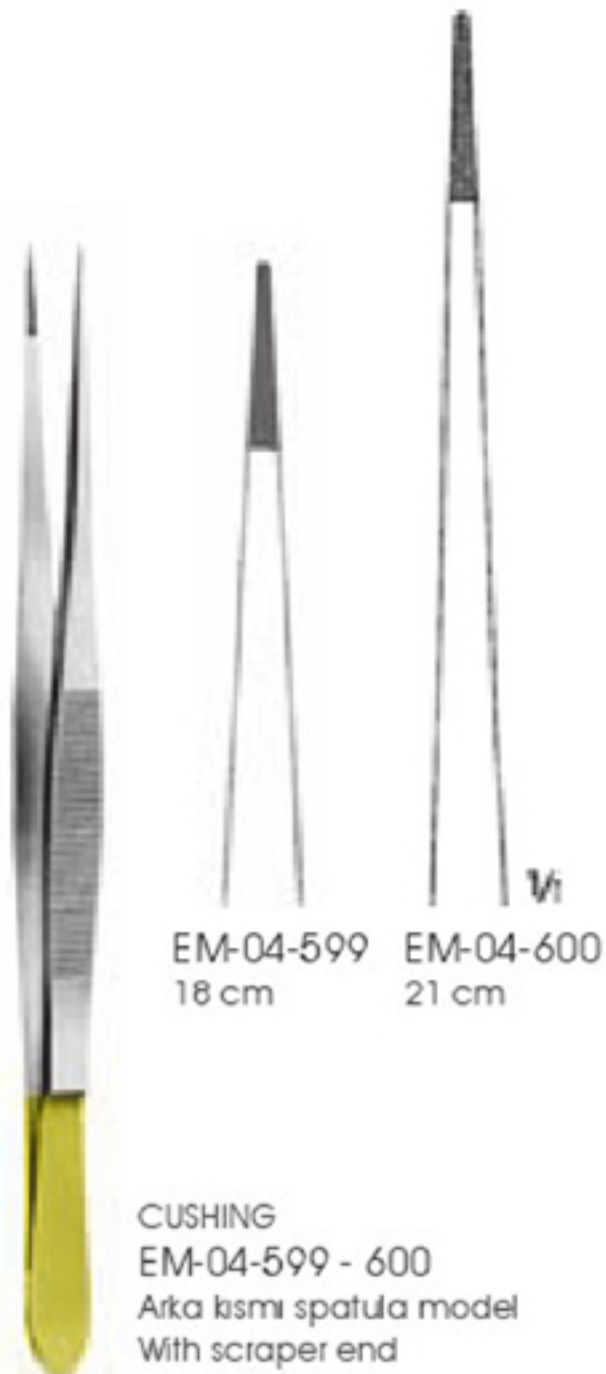
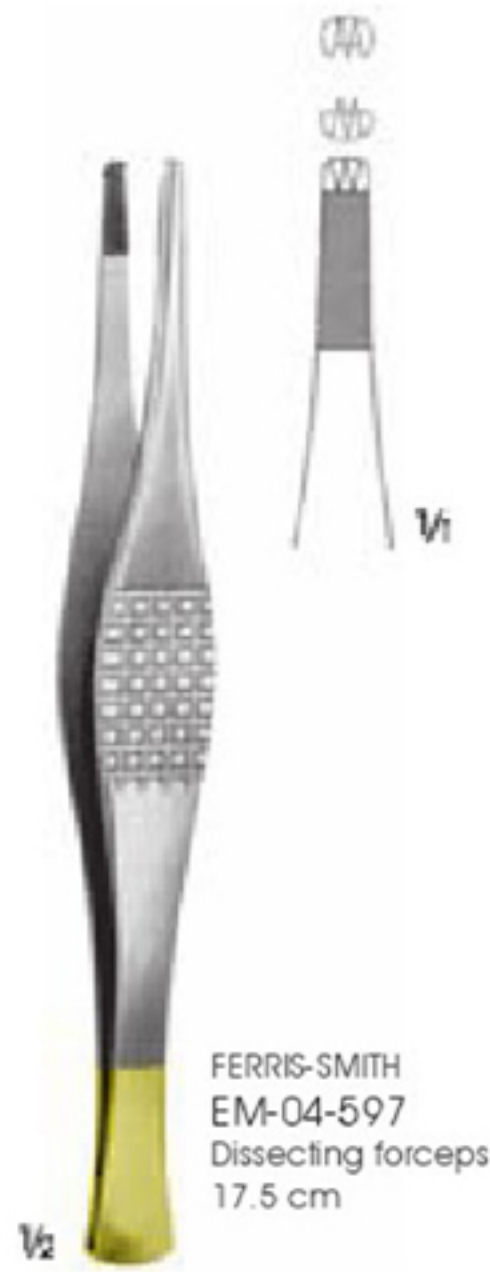

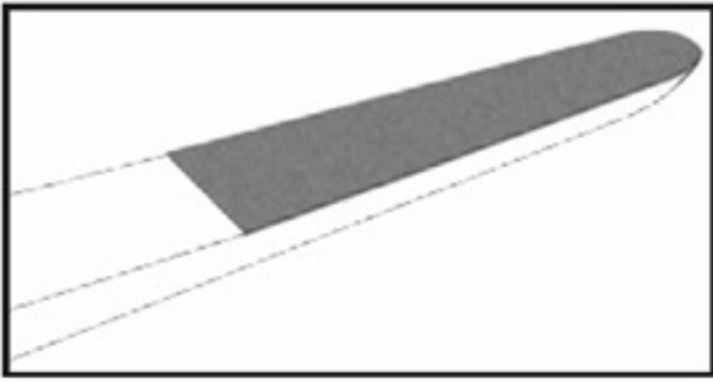

**DIAMOTE** jaws provide harder and more wear resistant surfaces.  
**DIAMOTE** jaws ensure reliable grip of fine needles, sutures and tissues.

	Ø 1.0 mm	Ø 1.0 mm	Ø 1.0 mm		Ø 1.0 mm	Ø 2.0 mm	Ø 1.0 mm
18.5 cm EM-04-603-01	EM-04-604-01	EM-04-605-01		15 cm EM-04-606-01	EM-04-607-01	EM-04-608-01	
21 cm EM-04-603-02	EM-04-604-02	EM-04-605-02		18.5 cm EM-04-606-02	EM-04-607-02	EM-04-608-02	
	Platform tip, straight	Straight	Curved	21 cm EM-04-606-03	EM-04-607-03	EM-04-608-03	
				23 cm EM-04-606-04	EM-04-607-04	EM-04-608-04	
				25 cm EM-04-606-05	EM-04-607-05	EM-04-608-05	
				Straight	Straight	Curved	

EM-04-603-01 - 605-02

Ø 2.5 mm    Ø 2.5 mm

	EM-04-609-01	EM-04-609-02
	18 cm	20 cm

EM-04-609-01 - 609-02

	Ø 1.2 mm	
		EM-04-610-01
		18 cm

	Ø 1.2 mm	
		EM-04-610-02
		22 cm

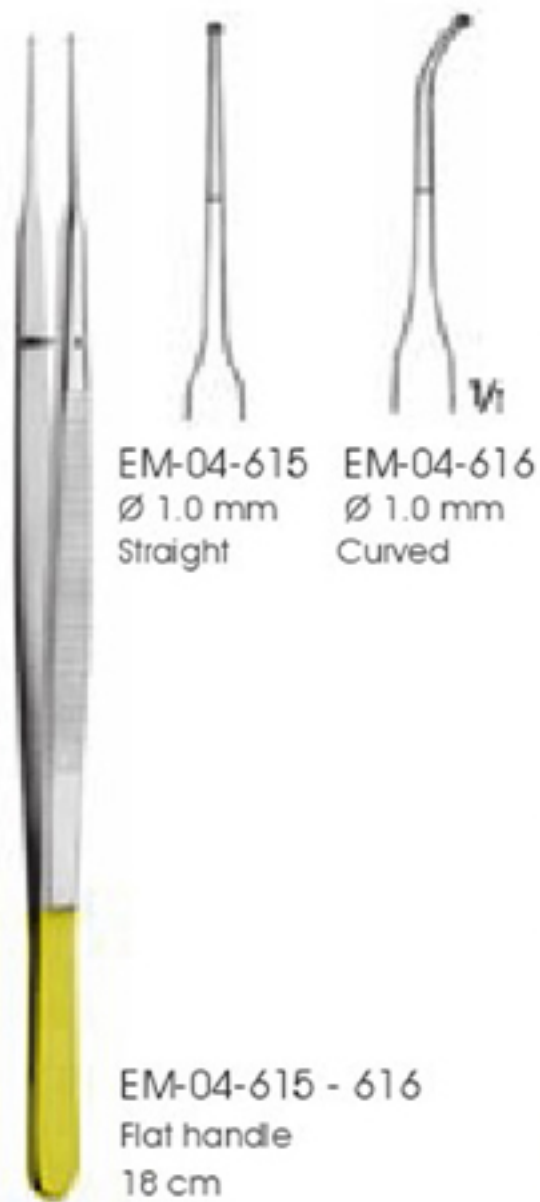
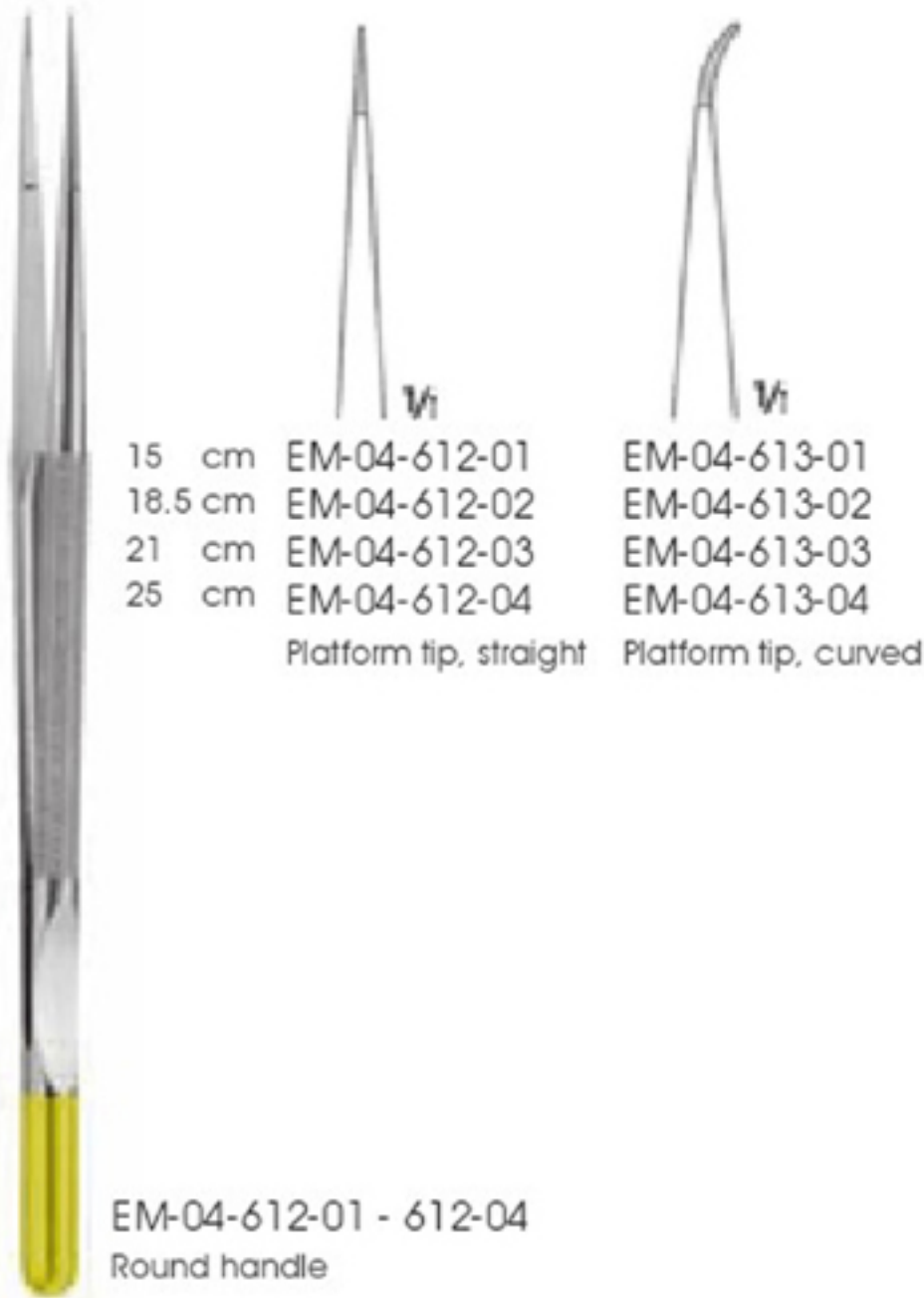



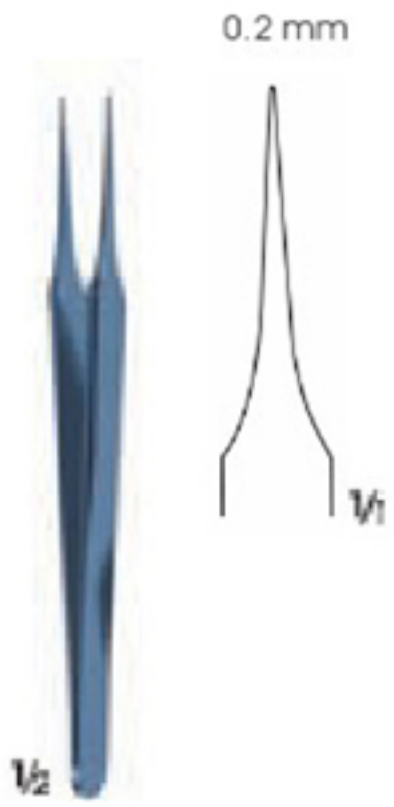

EM-04-620  
Micro forceps, jeweler patterns  
11 cm

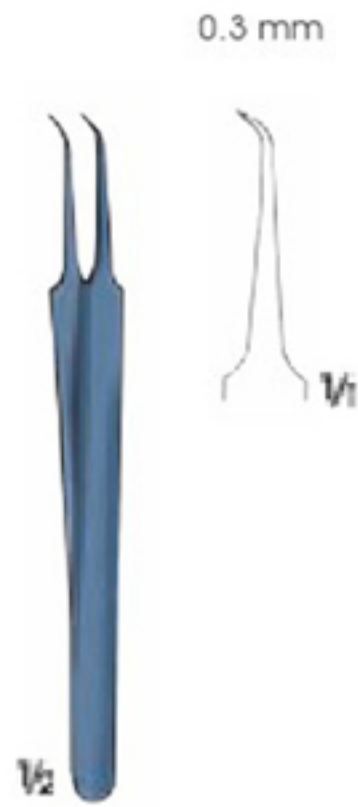

EM-04-621  
Micro forceps, jeweler patterns  
11 cm

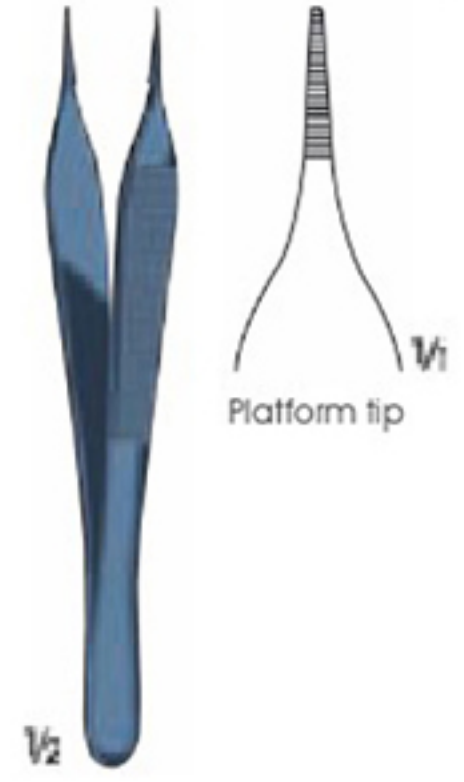

MICRO-ADSON  
EM-04-622  
Delicate dissecting forceps  
12 cm

Diamond



EM-04-623-01 18.5 cm  
EM-04-623-02 21 cm  
EM-04-623-03 23 cm  
Platform tip, straight

Diamond



EM-04-624-01 18.5 cm  
EM-04-624-02 21 cm  
EM-04-624-03 23 cm  
straight

Toothing De Bakay



EM-04-625-01 18.5 cm  
EM-04-625-02 21 cm  
EM-04-625-03 23 cm  
straight



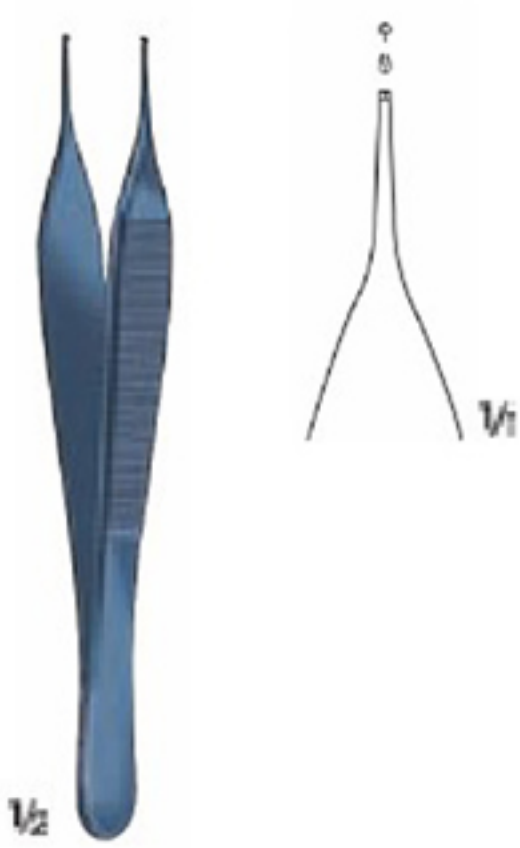

MICRO - ADSON  
EM-04-626  
Delicate tissue forceps  
12 cm

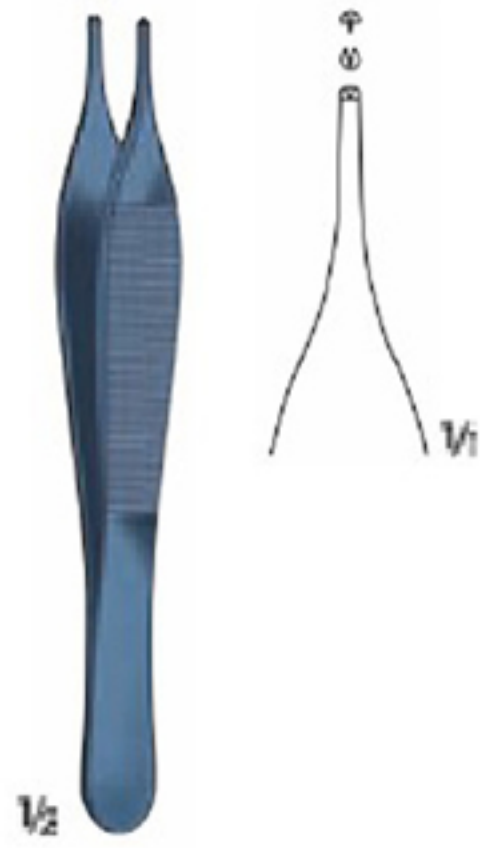

ADSON  
EM-04-627  
Delicate tissue forceps  
12 cm

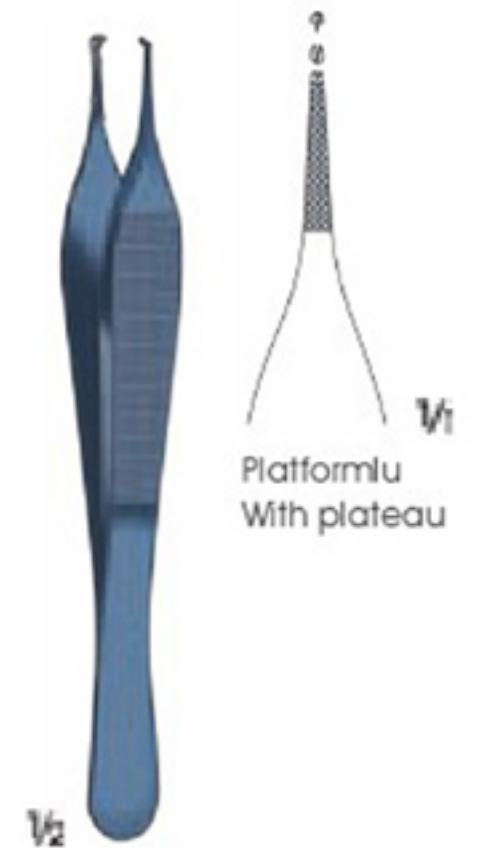

ADSON  
EM-04-628  
Delicate tissue forceps  
12 cm



EM-04-629-01  
13 cm



EM-04-629-02  
14.5 cm



EM-04-629-03  
16 cm



EM-04-629-04  
18 cm



EM-04-629-05  
20 cm

EM-04-629-01 - 629-05  
Tissue forceps, standard patterns

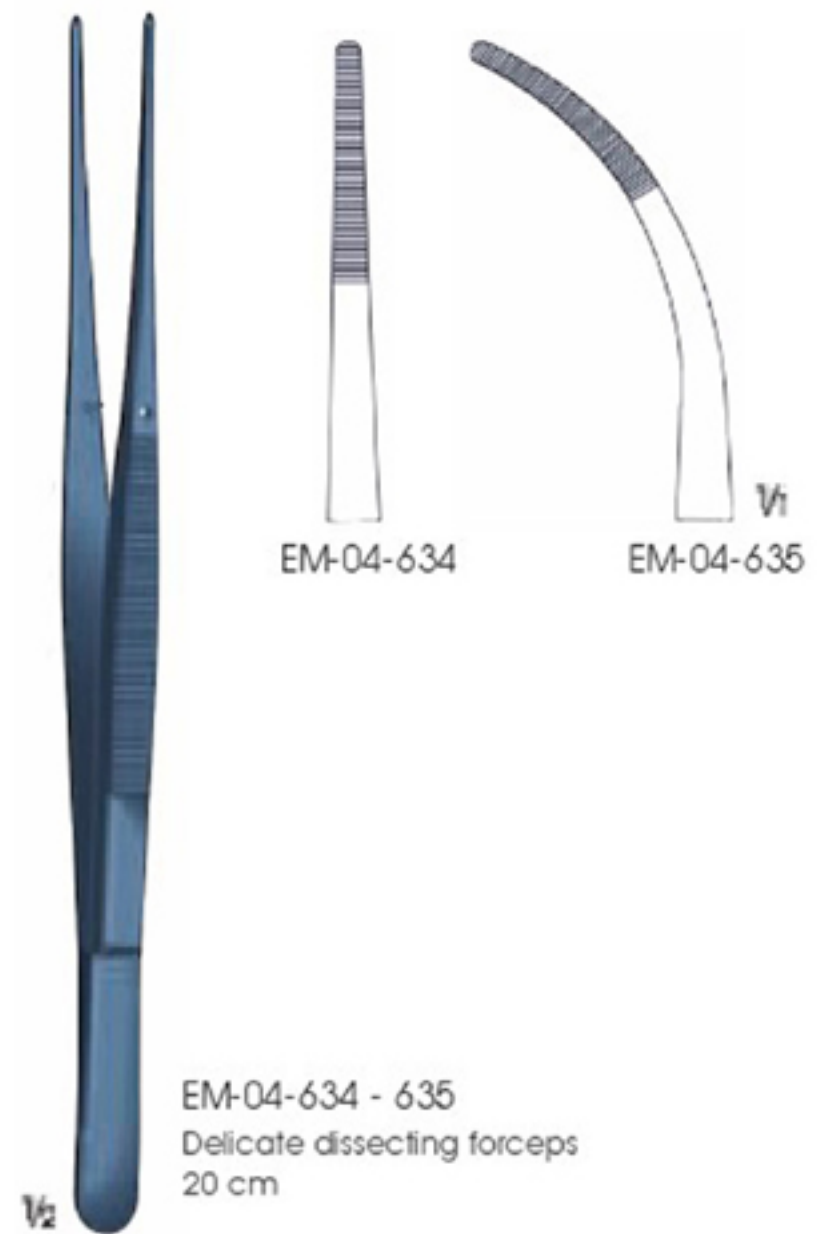
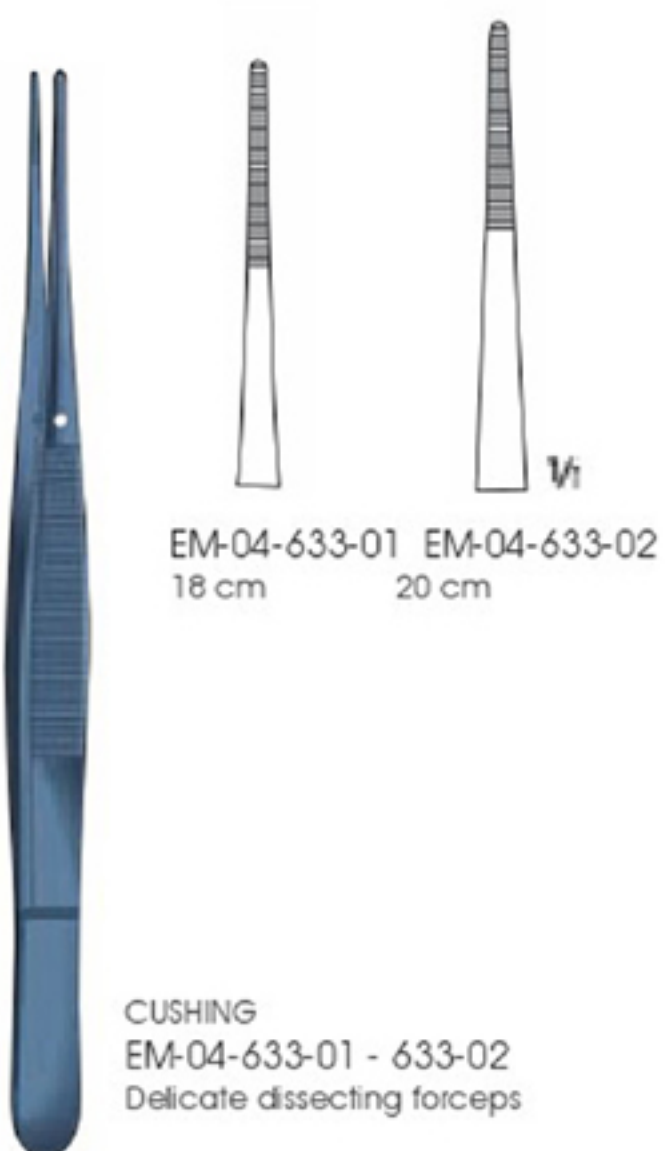
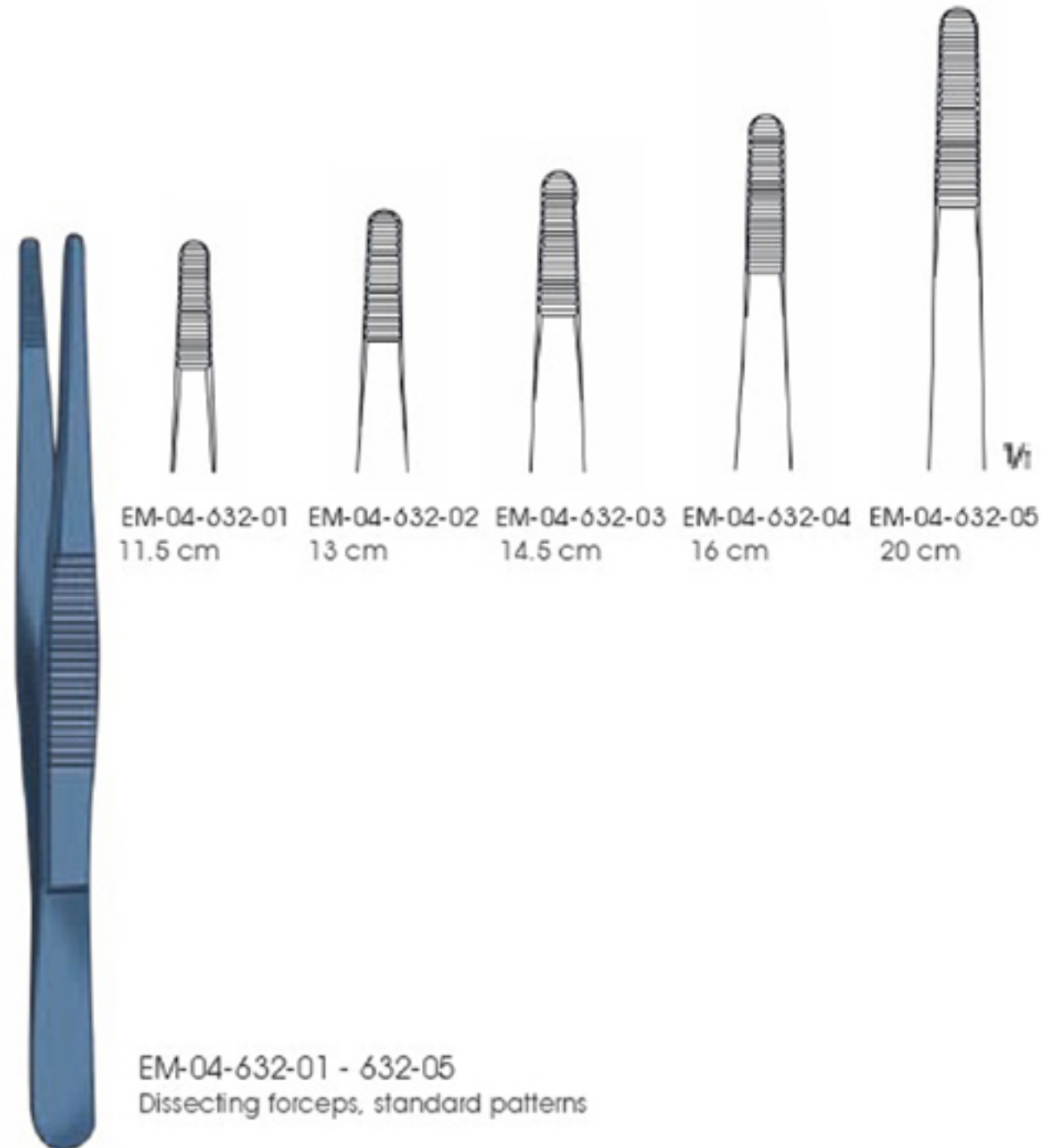
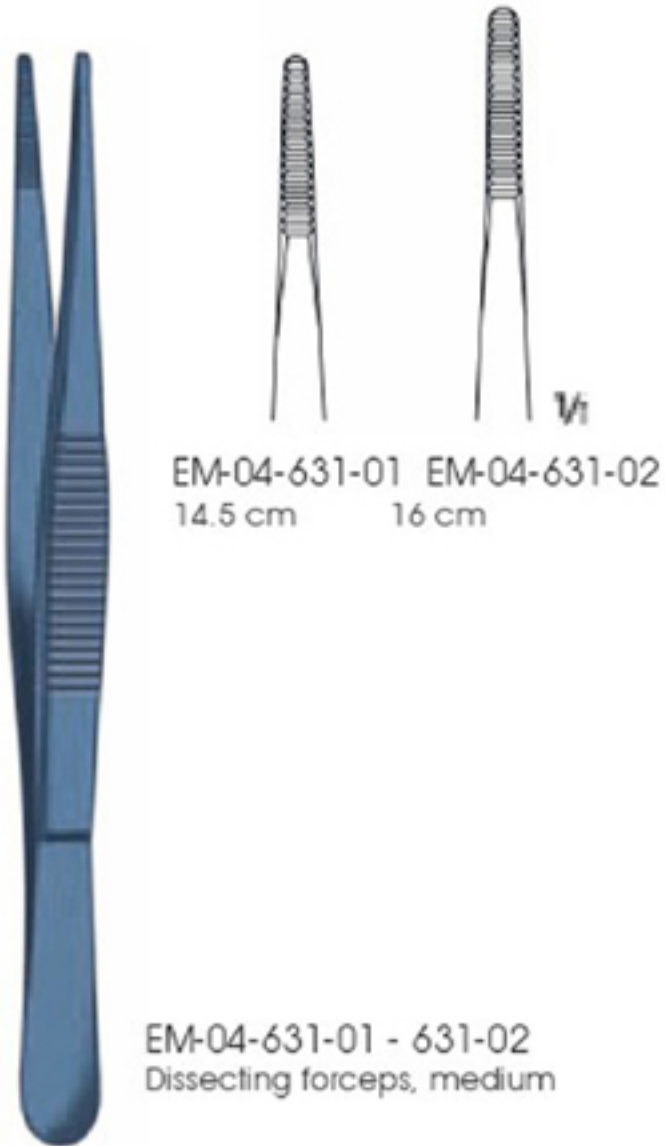



Toothing De Bakey

