

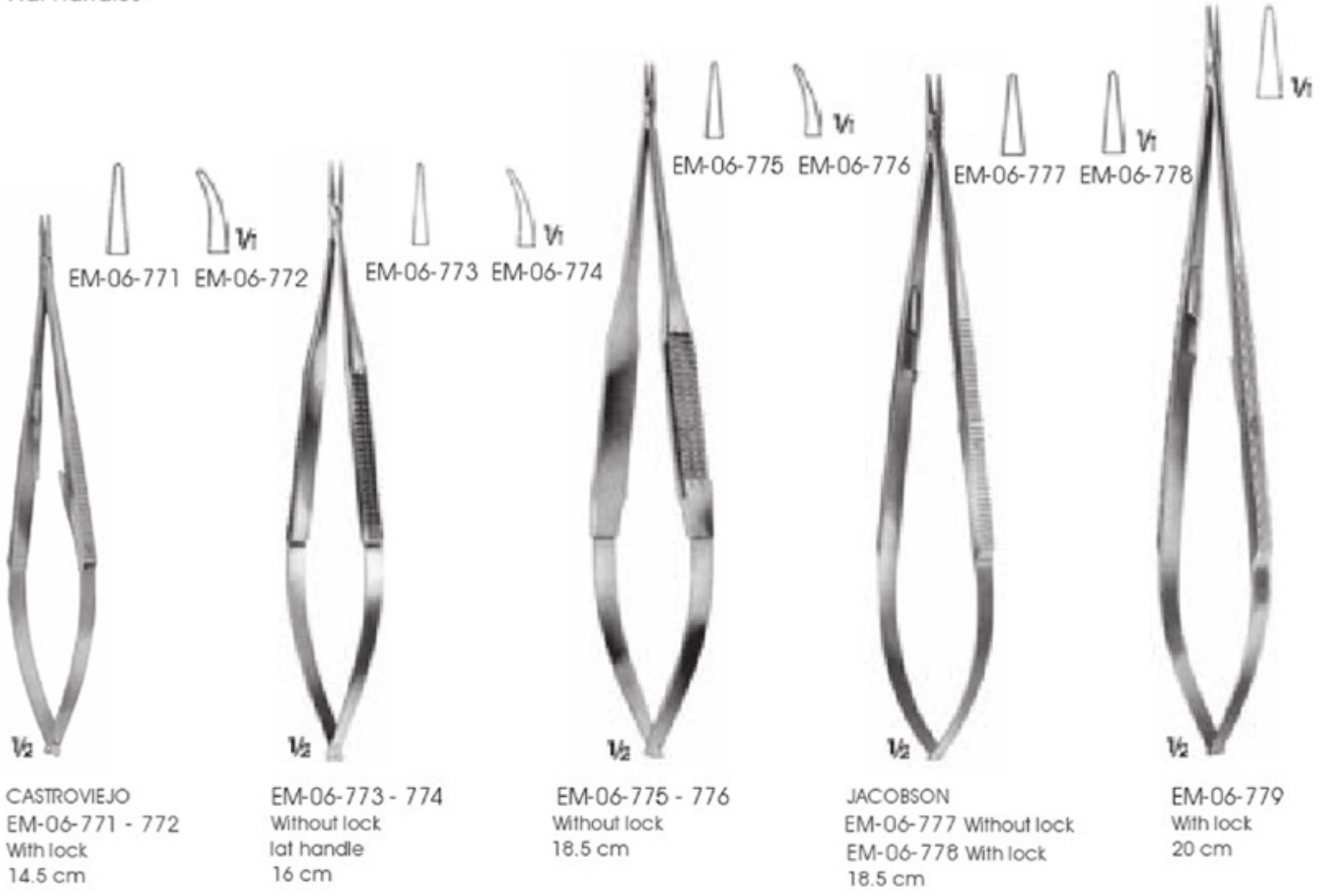

# Needle Holders And Suture Forceps

## Nadelhalter und Nahtzange

Flat Handles



CASTROVIEJO  
EM-06-771 - 772  
With lock  
14.5 cm

EM-06-773 - 774  
Without lock  
lat handle  
16 cm

EM-06-775 - 776  
Without lock  
18.5 cm

JACOBSON  
EM-06-777 Without lock  
EM-06-778 With lock  
18.5 cm

EM-06-779  
With lock  
20 cm

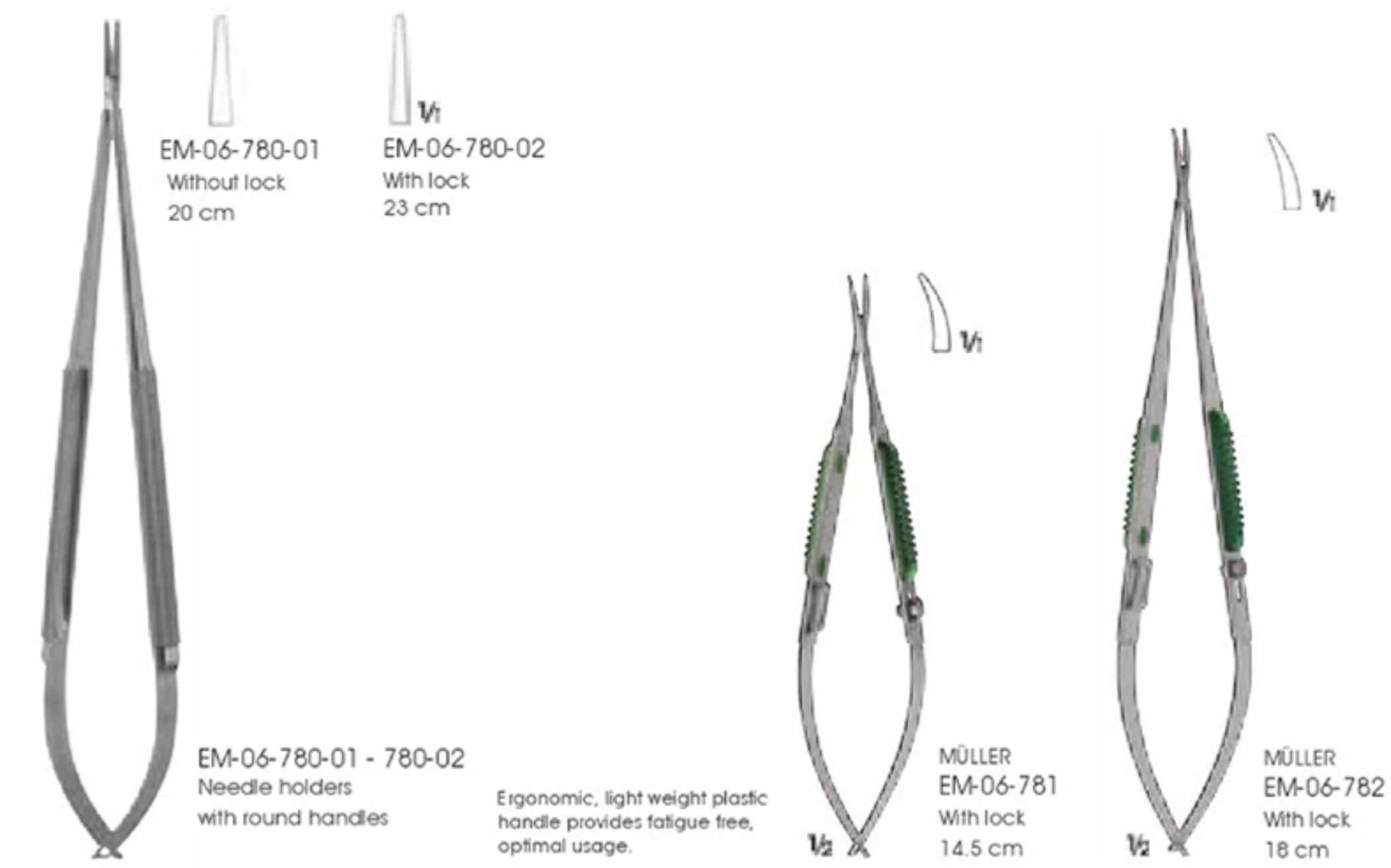

EM-06-780-01  
Without lock  
20 cm

EM-06-780-02  
With lock  
23 cm

EM-06-780-01 - 780-02  
Needle holders  
with round handles

Ergonomic, light weight plastic  
handle provides fatigue free,  
optimal usage.

MÜLLER  
EM-06-781  
With lock  
14.5 cm

MÜLLER  
EM-06-782  
With lock  
18 cm

Round Handle  
 Allows rotation between the fingers as required  
 Due to carved and strong handle, each instrument provides optimum balance

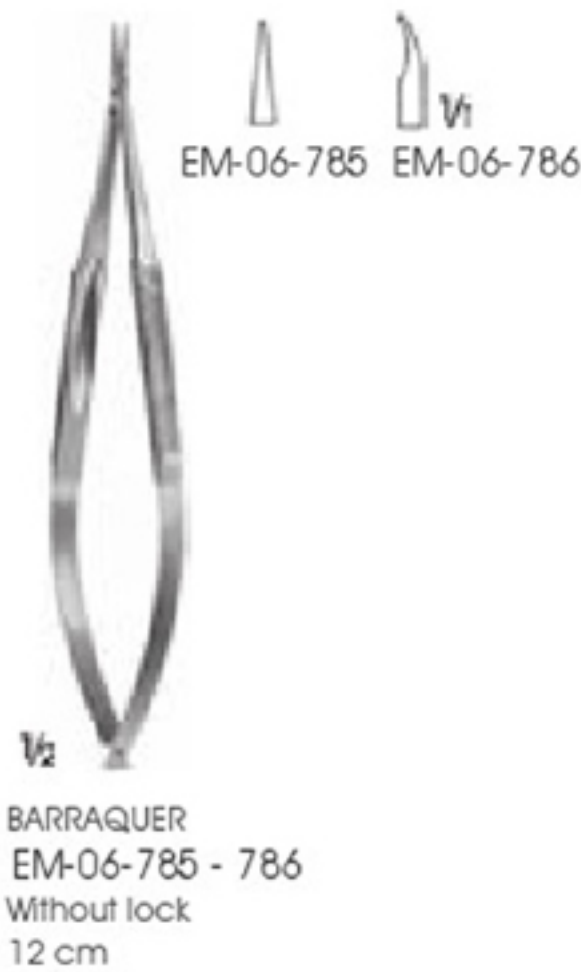



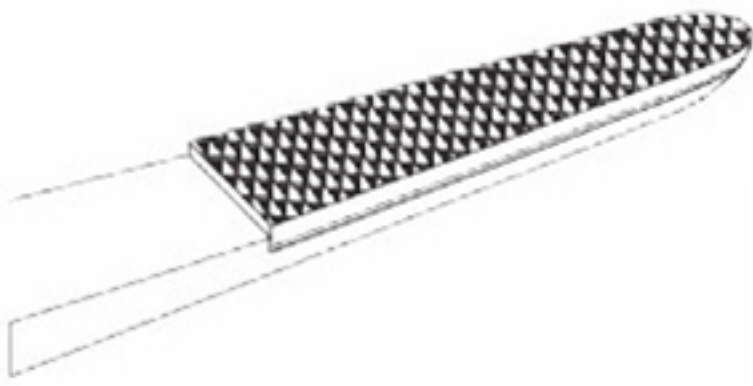

Needle holders with carbide inserts.  
The carbide inserts on BAHADIR needle holders can be selected based on usage.  
BAHADIR needle holders with carbide inserts have four different surface types. Smooth surface and three different notched surfaces provide appropriate needle catch.



smooth

With smooth jaw surface for suture materials: 9/0 - 11/0



0,2

With 0.2 mm pitch of serration for suture material: 6/0 - 10/0



0,4

0.4 mm pitch of serration for suture material: 4/0 - 6/0



0,5

0.5 mm pitch of serration for suture material: up to 3/0

<p>With smooth jaw</p>					
<p>CASTROVIEJO EM-06-797 With lock 14.5 cm</p>	<p>CASTROVIEJO EM-06-798 With lock 14.5 cm</p>	<p>EM-06-799 With lock 17 cm</p>	<p>CASTROVIEJO EM-06-800-01 - 800-02 With lock</p>	<p>EM-06-801-01 With lock 18 cm</p>	<p>EM-06-801-02 With lock 20 cm</p>



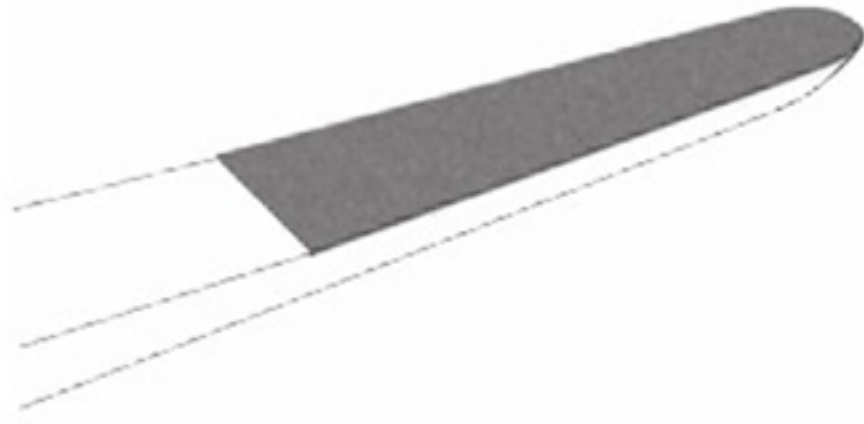

**DIAMOTE** jaws provide harder and more wear resistant surfaces.  
**DIAMOTE** jaws ensure reliable grip of fine needles, sutures and tissues.



EM-06-802-01 - 802-02  
With lock  
18 cm



EM-06-803  
With lock  
21 cm



EM-06-804  
Without lock  
21 cm



  $\frac{1}{16}$   
For sutures 5-0  
and smaller

GLASSER  
EM-06-805  
With lock  
12.5 cm



  $\frac{1}{16}$   
For sutures 5-0  
and smaller

GLASSER  
EM-06-806  
With lock  
18 cm



  $\frac{1}{16}$   
EM-06-807-01  
14 cm

  $\frac{1}{16}$   
EM-06-807-02  
16 cm

  $\frac{1}{16}$   
EM-06-807-03  
18 cm

  $\frac{1}{16}$   
EM-06-807-04  
22 cm

  $\frac{1}{16}$   
EM-06-807-05  
25 cm

RYDER  
EM-06-807-01 - 807-05  
For sutures 5-0  
and smaller

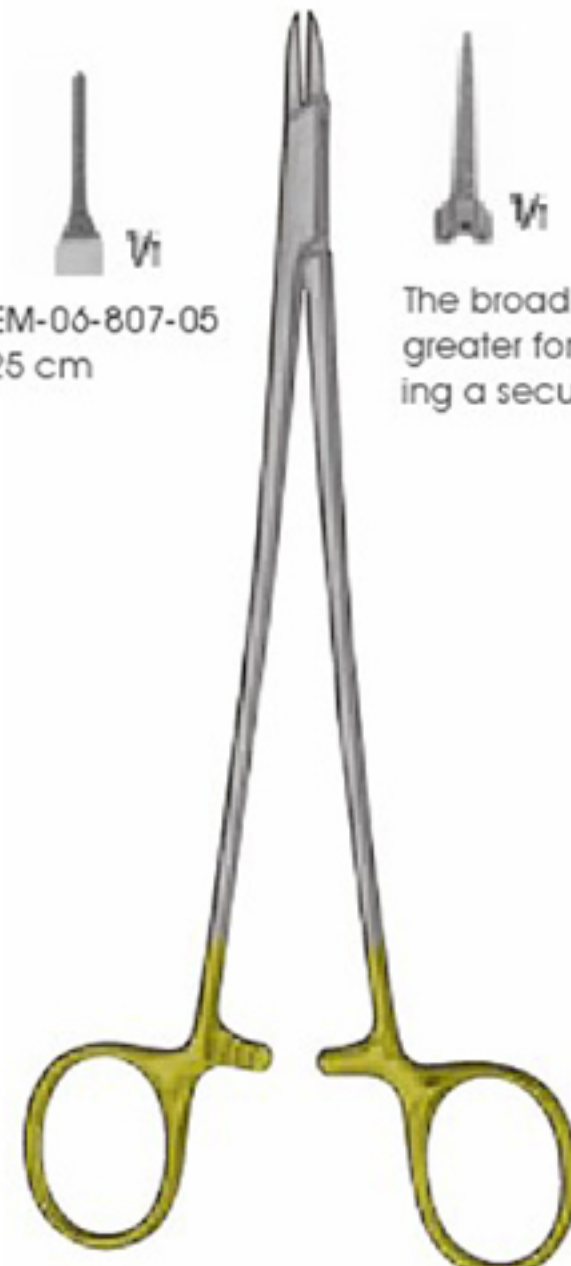

  $\frac{1}{16}$   
The broad back of the jaw exerts  
greater force on the needle, facilitat-  
ing a secure hold.

EM-06-808  
19.5 cm



For sutures 7-0  
and smaller

18.5 cm EM-06-809-01  
21 cm EM-06-809-02  
23 cm EM-06-809-03  
With lock

18.5 cm EM-06-809-04  
21 cm EM-06-809-05  
23 cm EM-06-809-06  
Without lock



For sutures 5-0  
and smaller







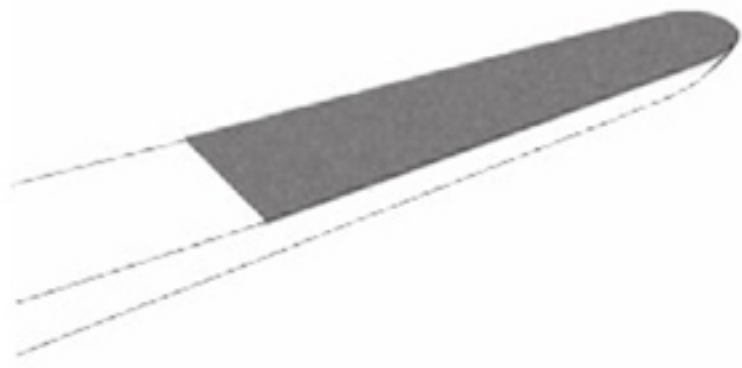



18.5 cm EM-06-809-07  
21 cm EM-06-809-08  
23 cm EM-06-809-09  
With lock

18.5 cm EM-06-809-10  
21 cm EM-06-809-11  
23 cm EM-06-809-12  
Without lock







**DIAMOTE** jaws provide harder and more wear resistant surfaces.  
**DIAMOTE** jaws ensure reliable grip of fine needles, sutures and tissues.

	For sutures 7-0 and smaller	For sutures 5-0 and smaller		For sutures 7-0 and smaller	For sutures 5-0 and smaller	For sutures 4-0 and smaller	For sutures 4-0 and smaller
							
		 $\nabla$					 $\nabla$
	12 cm EM-06-810-01	EM-06-810-07		12 cm EM-06-811-01	EM-06-811-07	EM-06-811-13	EM-06-811-19
	14.5 cm EM-06-810-02	EM-06-810-08		14.5 cm EM-06-811-02	EM-06-811-08	EM-06-811-14	EM-06-811-20
	16 cm EM-06-810-03	EM-06-810-09		16 cm EM-06-811-03	EM-06-811-09	EM-06-811-15	EM-06-811-21
	18.5 cm EM-06-810-04	EM-06-810-10		18.5 cm EM-06-811-04	EM-06-811-10	EM-06-811-16	EM-06-811-22
	21 cm EM-06-810-05	EM-06-810-11		21 cm EM-06-811-05	EM-06-811-11	EM-06-811-17	EM-06-811-23
	23 cm EM-06-810-06	EM-06-810-12		23 cm EM-06-811-06	EM-06-811-12	EM-06-811-18	EM-06-811-24
	EM-06-810-01 - 810-12 Without lock			EM-06-811-01 - 811-24 With lock			

For sutures 2-0 and smaller

  $\nabla$ 

19 cm EM-06-812-01  
 23 cm EM-06-812-02  
 25 cm EM-06-812-03



EM-06-812-01 - 812-03  
 Without lock

For sutures 2-0 and smaller

  $\nabla$ 

19 cm EM-06-812-04  
 23 cm EM-06-812-05  
 25 cm EM-06-812-06



EM-06-812-04 - 812-06  
 With lock

Flat Handle

For sutures 7-0 and smaller

For sutures 5-0 and smaller



14.5 cm	EM-06-813-01	EM-06-813-06
17 cm	EM-06-813-02	EM-06-813-07
18.5 cm	EM-06-813-03	EM-06-813-08
21 cm	EM-06-813-04	EM-06-813-09
23 cm	EM-06-813-05	EM-06-813-10

EM-06-813-01 - 813-10  
Without lock

For sutures 7-0 and smaller

For sutures 5-0 and smaller



14.5 mm	EM-06-813-11	EM-06-813-16
17 cm	EM-06-813-12	EM-06-813-17
18.5 cm	EM-06-813-13	EM-06-813-18
21 cm	EM-06-813-14	EM-06-813-19
23 cm	EM-06-813-15	EM-06-813-20

EM-06-813-11 - 813-20  
With lock

Flat Knurled Handle

For sutures 5-0 and smaller



18.5 cm	EM-06-814-01
21 cm	EM-06-814-02
23 cm	EM-06-814-03

EM-06-814-01 - 814-03  
Without lock

For sutures 5-0 and smaller



18.5 cm	EM-06-814-04
21 cm	EM-06-814-05
23 cm	EM-06-814-06

EM-06-814-04 - 814-06  
With lock

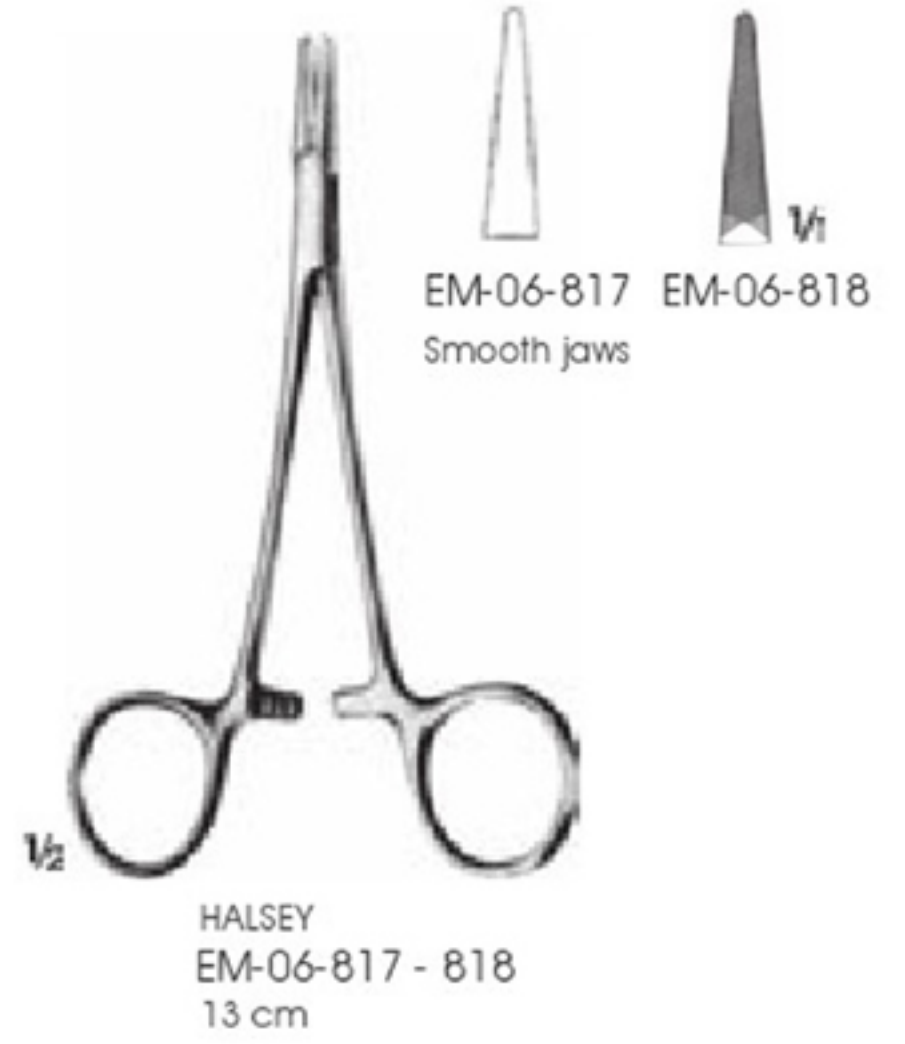





DOYEN  
EM-06-822  
12.5 cm



CRILE-WOOD  
EM-06-823  
15 cm



CRILE-WOOD  
EM-06-824  
16 cm

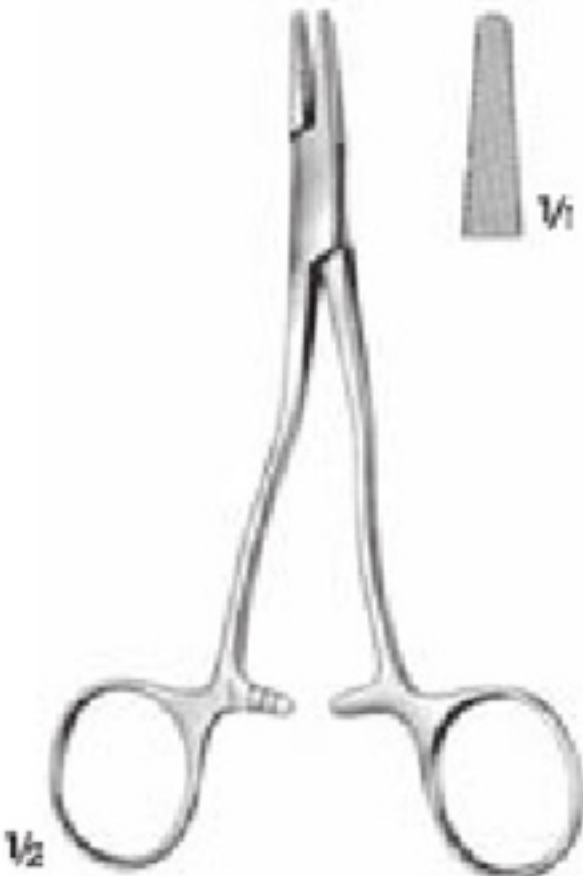

KILNER  
EM-06-825  
13.5 cm

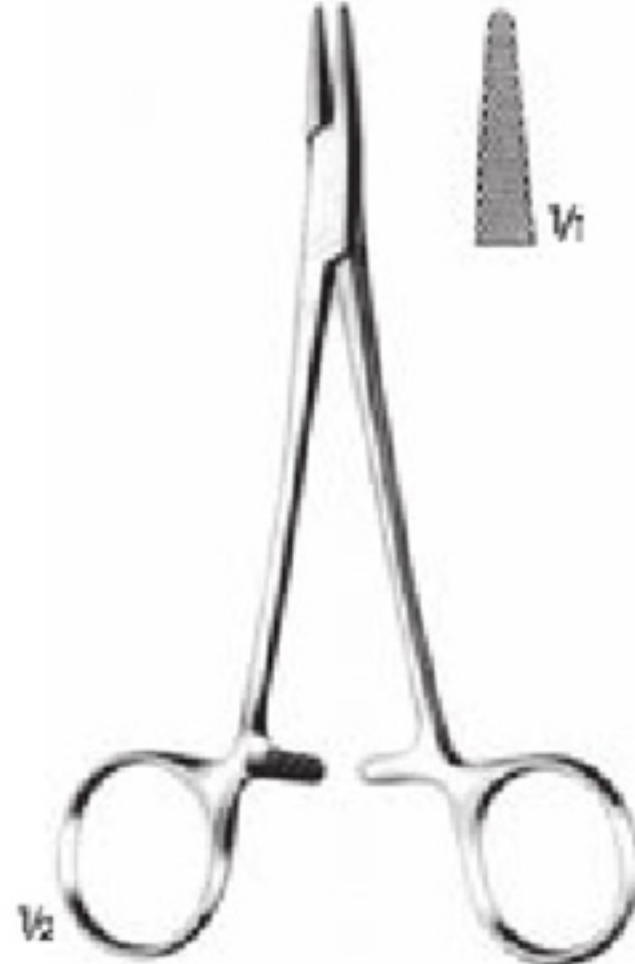

CRILE-MURRAY  
EM-06-826  
15 cm



MAYO-HEGAR  
EM-06-827-01 827-02

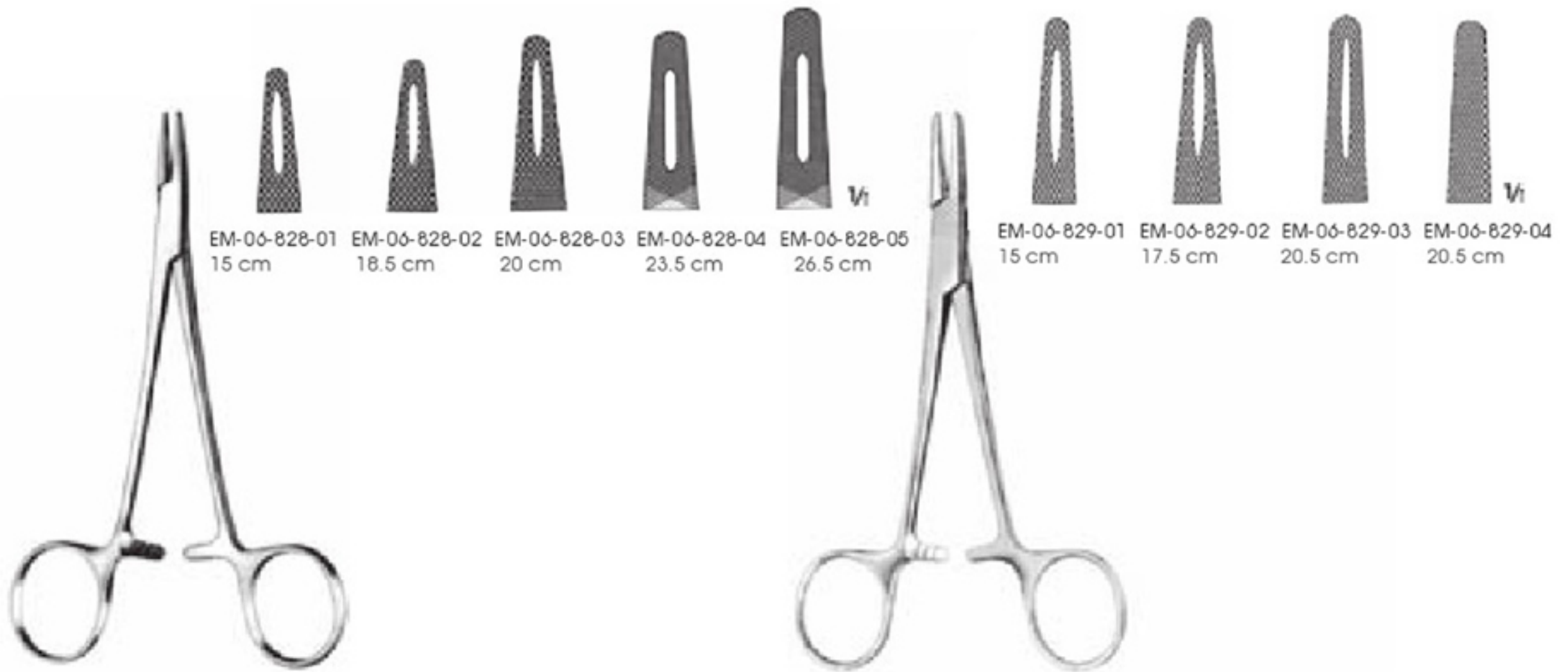

MAYO-HEGAR  
EM-06-828-01 - 828-05  
Medium fine patterns

HEGAR  
EM-06-829-01 - 829-04  
Heavy patterns

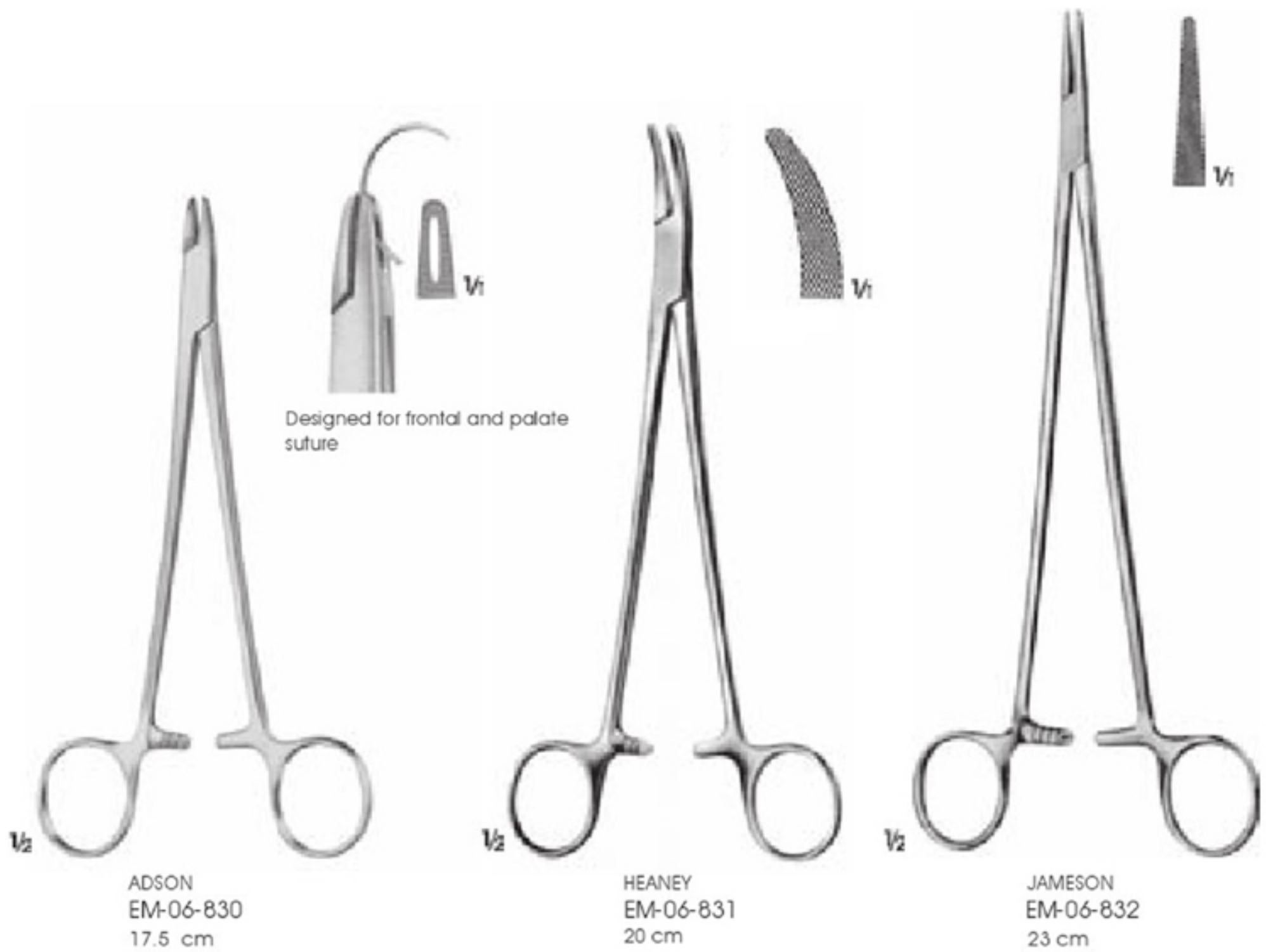

$\frac{1}{2}$   
ADSON  
EM-06-830  
17.5 cm

$\frac{1}{2}$   
HEANEY  
EM-06-831  
20 cm

$\frac{1}{2}$   
JAMESON  
EM-06-832  
23 cm

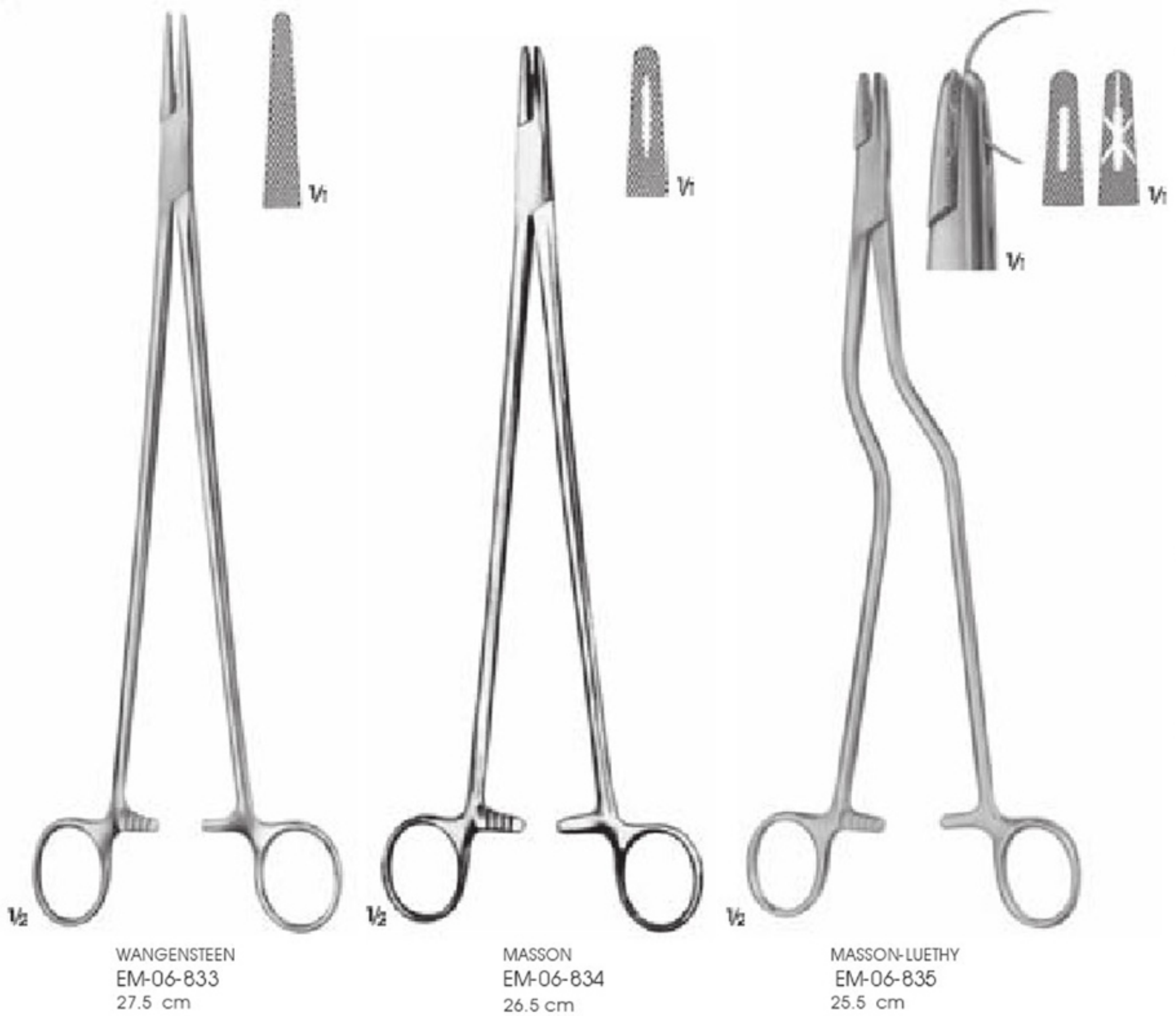





HEGAR-OLSEN  
EM-06-836 - 837



EM-06-836  
14 cm



EM-06-837  
18.5 cm



GILLIES  
EM-06-838  
15 cm



GILLIES  
EM-06-839  
16 cm

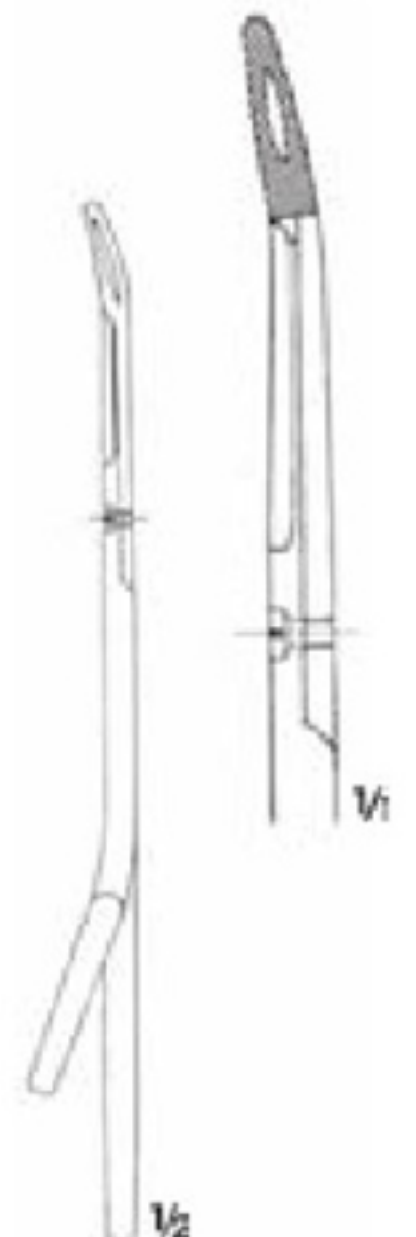



CRILE  
EM-06-840  
15 cm



TÖNNIS  
EM-06-841  
Elastic pattern for dura- or intestinal suture  
18 cm



MATHIEU  
EM-06-842-01 - 842-03

EM-06-842-01 14 cm  
EM-06-842-02 17 cm  
EM-06-842-03 20 cm



MATHIEU - STILLE  
EM-06-843-01 - 843-02  
Very heavy patterns

EM-06-843-01 17.5 cm  
EM-06-843-02 20 cm

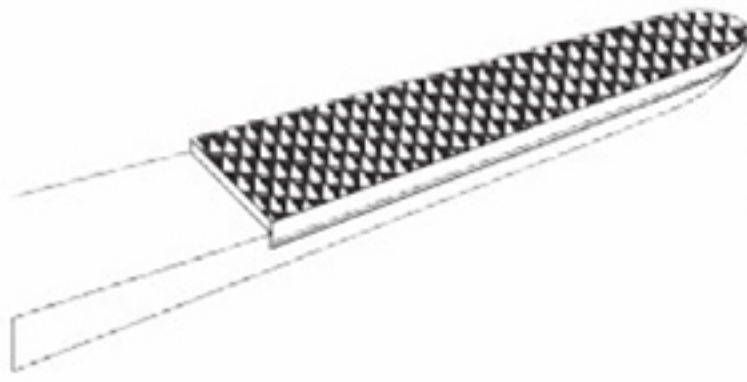

Needle holders with carbide inserts.

The carbide inserts on BAHADIR needle holders can be selected based on usage.

BAHADIR needle holders with carbide inserts have four different surface types. Smooth surface and three different notched surfaces provide appropriate needle catch.



Düz  
smooth

With smooth jaw surface for suture materials: 9/0 - 11/0



0,2

With 0.2 mm pitch of serration for suture material: 6/0 - 10/0



0,4

0.4 mm pitch of serration for suture material: 4/0 - 6/0



0,5

0.5 mm pitch of serration for suture material: up to 3/0

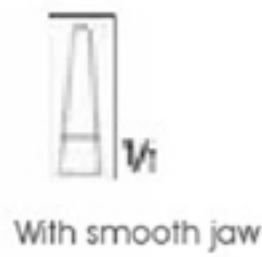

HALSEY  
EM-06-844  
12 cm

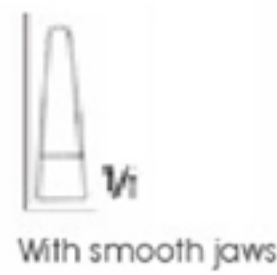
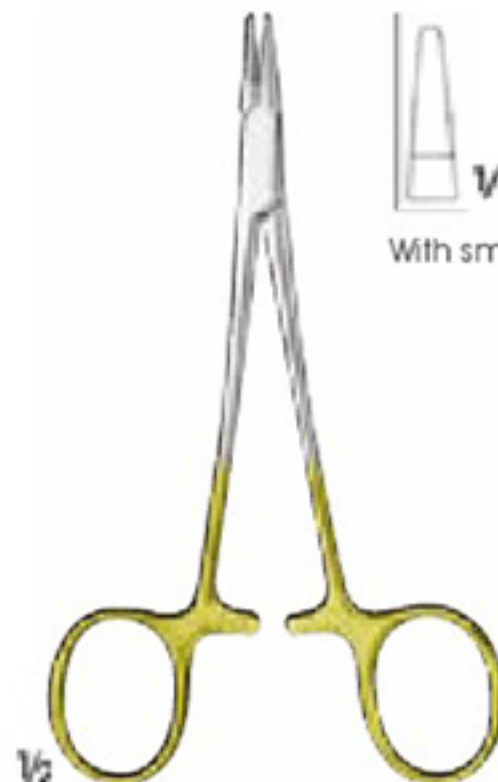

WEBSTER  
EM-06-845  
12.5 cm



MASING  
EM-06-846  
One ring angled  
13 cm



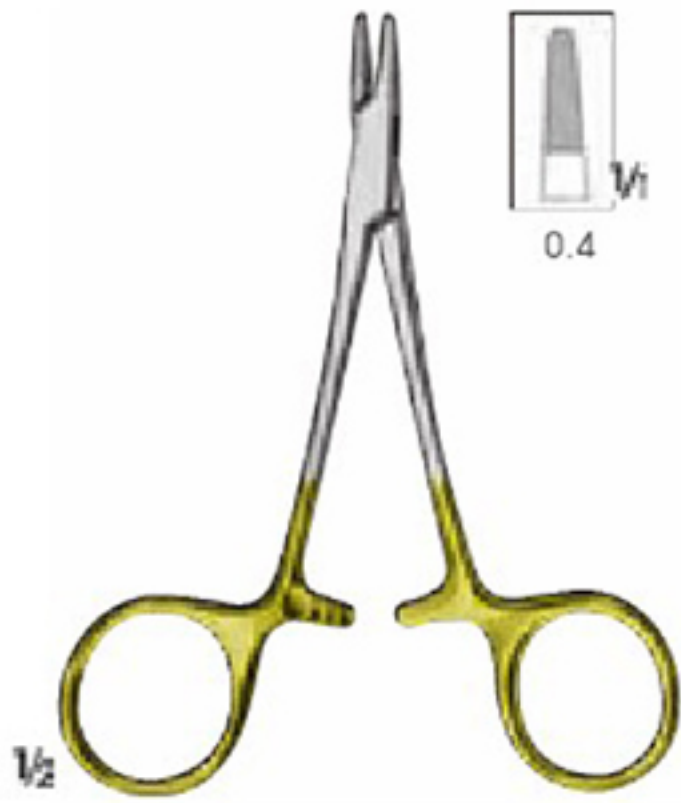

DERF  
EM-06-847  
11.5 cm



HALSEY  
EM-06-848  
13 cm

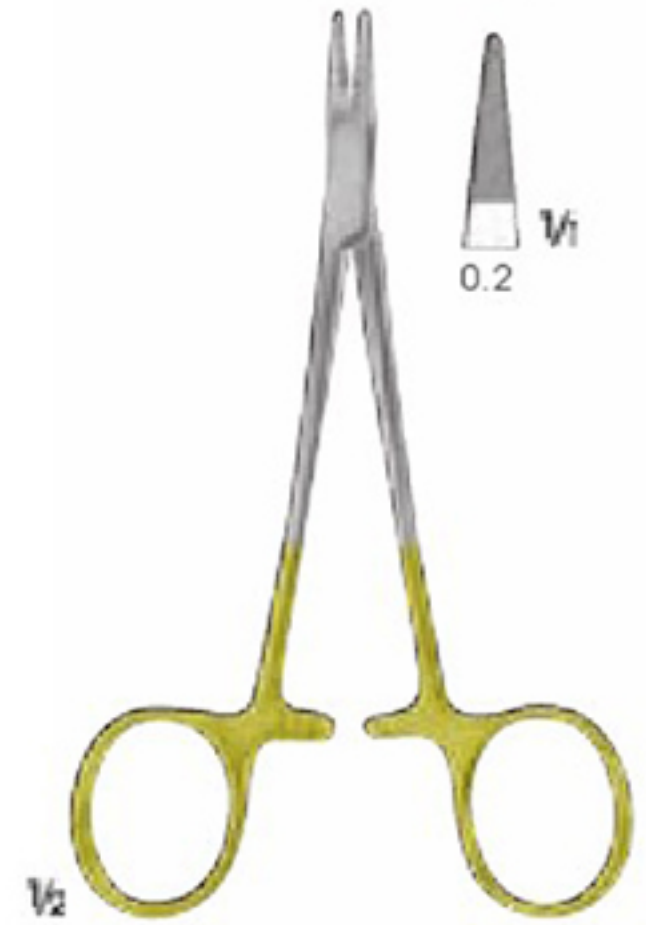

CONVERSE  
EM-06-849  
13 cm

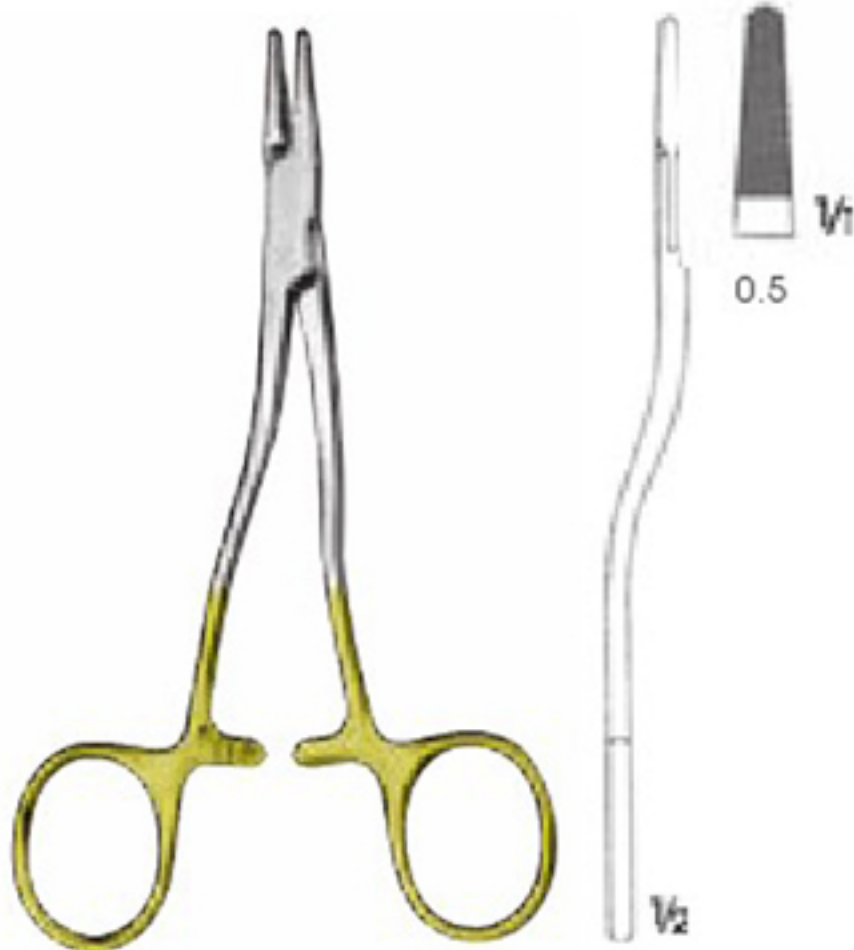

KILNER  
EM-06-850  
13.5 cm

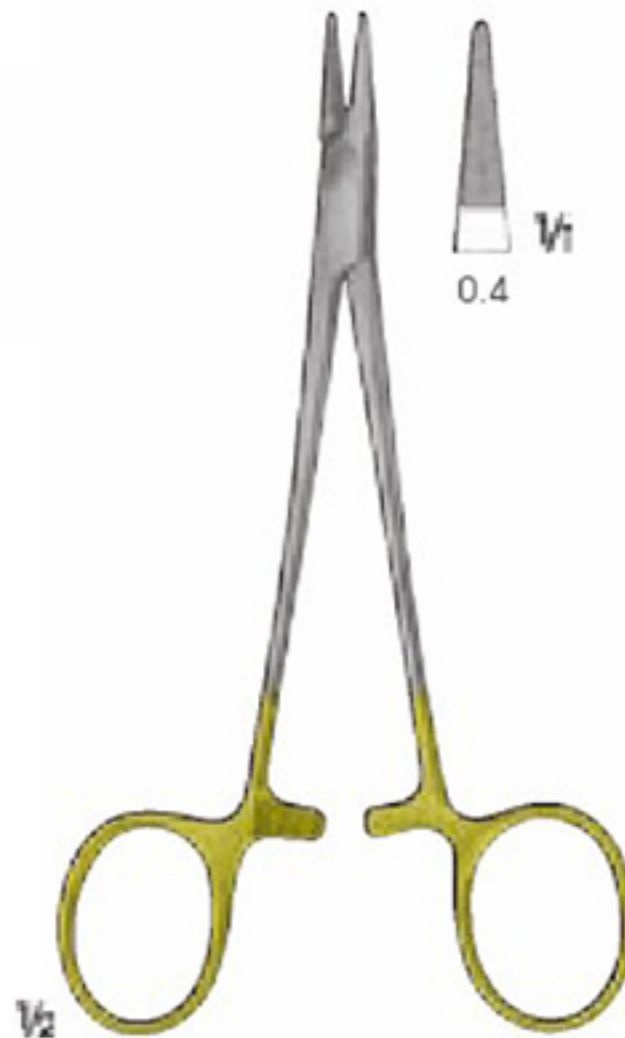

BABY-CRILE-WOOD  
EM-06-851  
15 cm



BAUMGARTNER  
EM-06-852  
14.5 cm

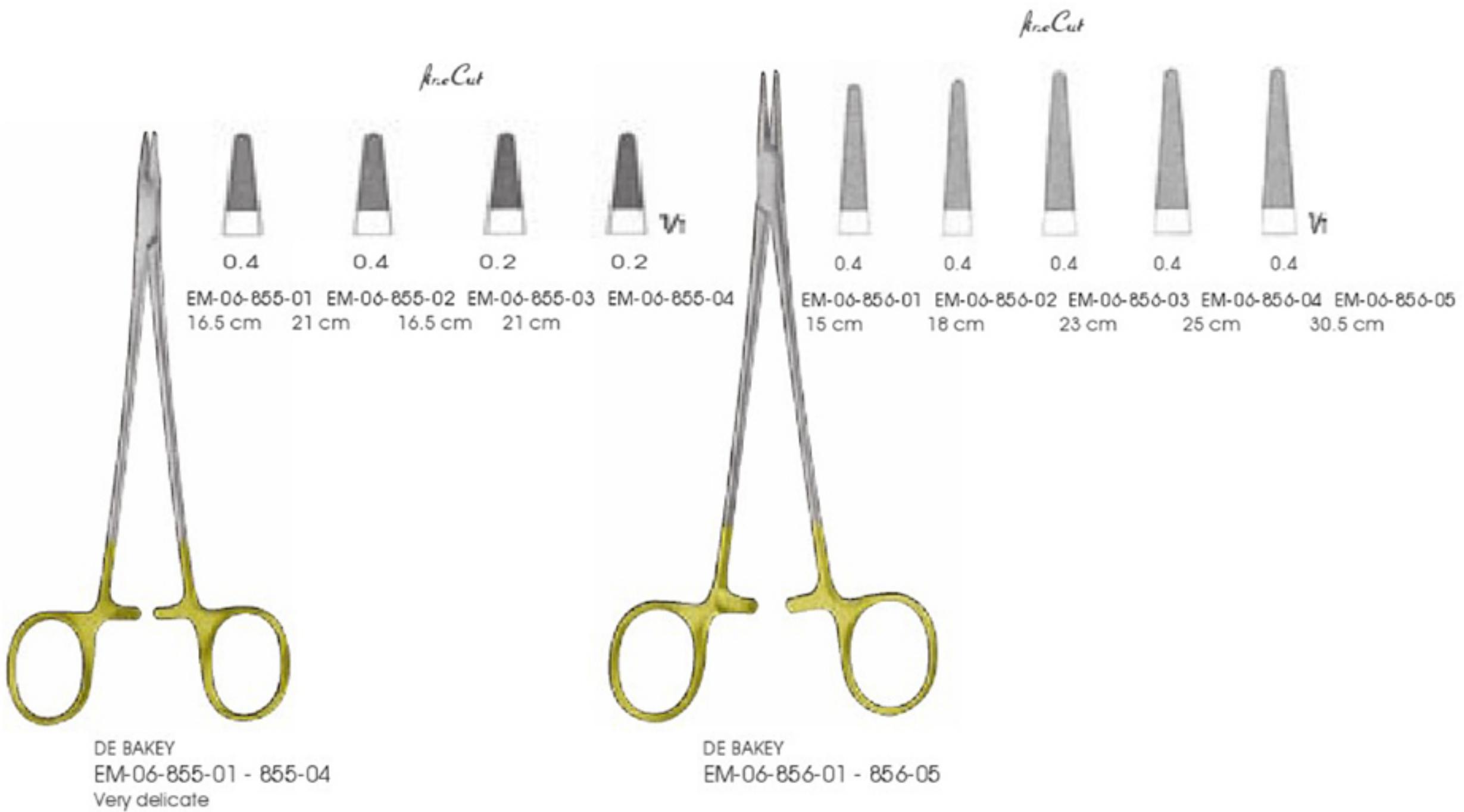
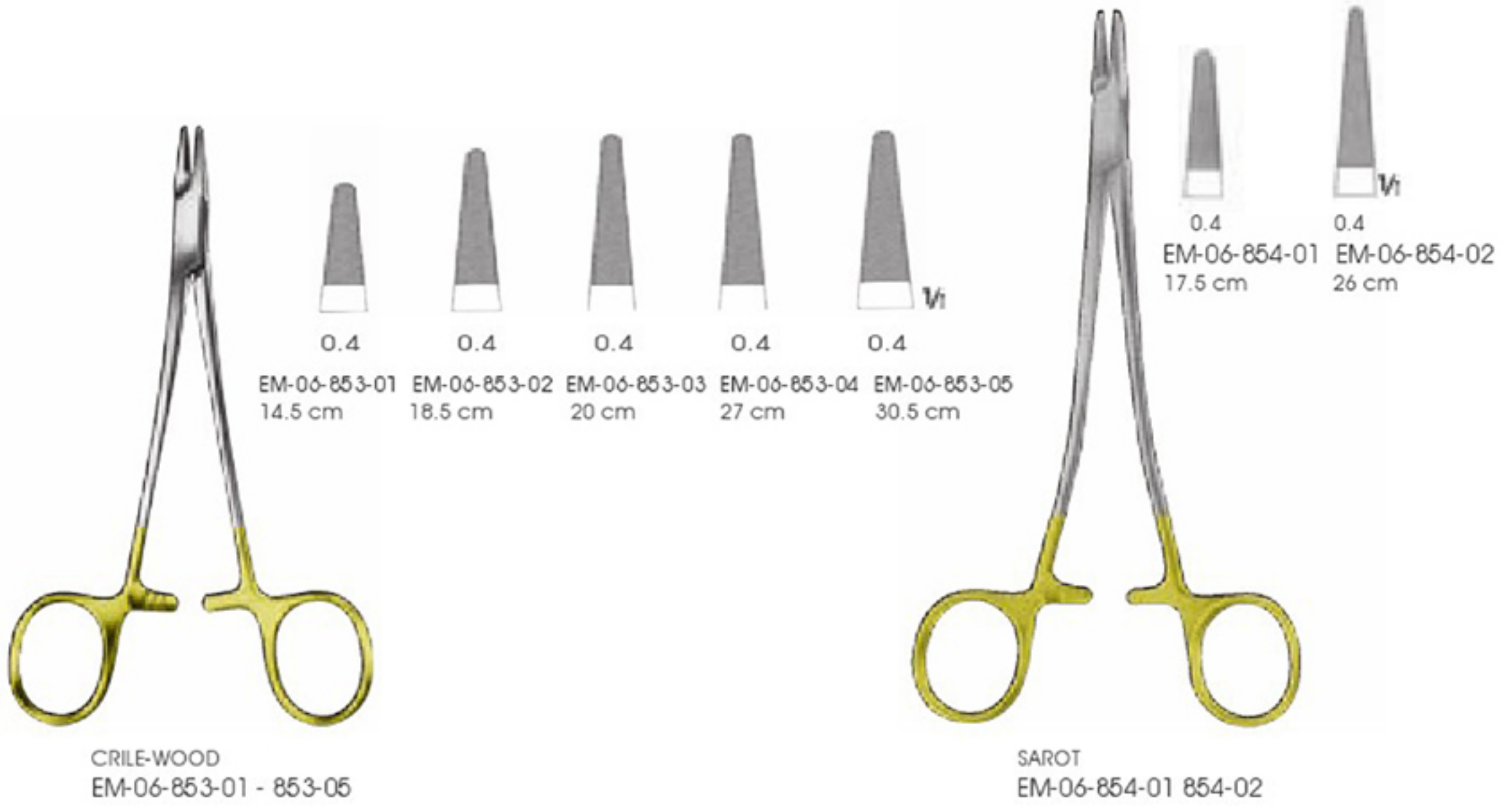

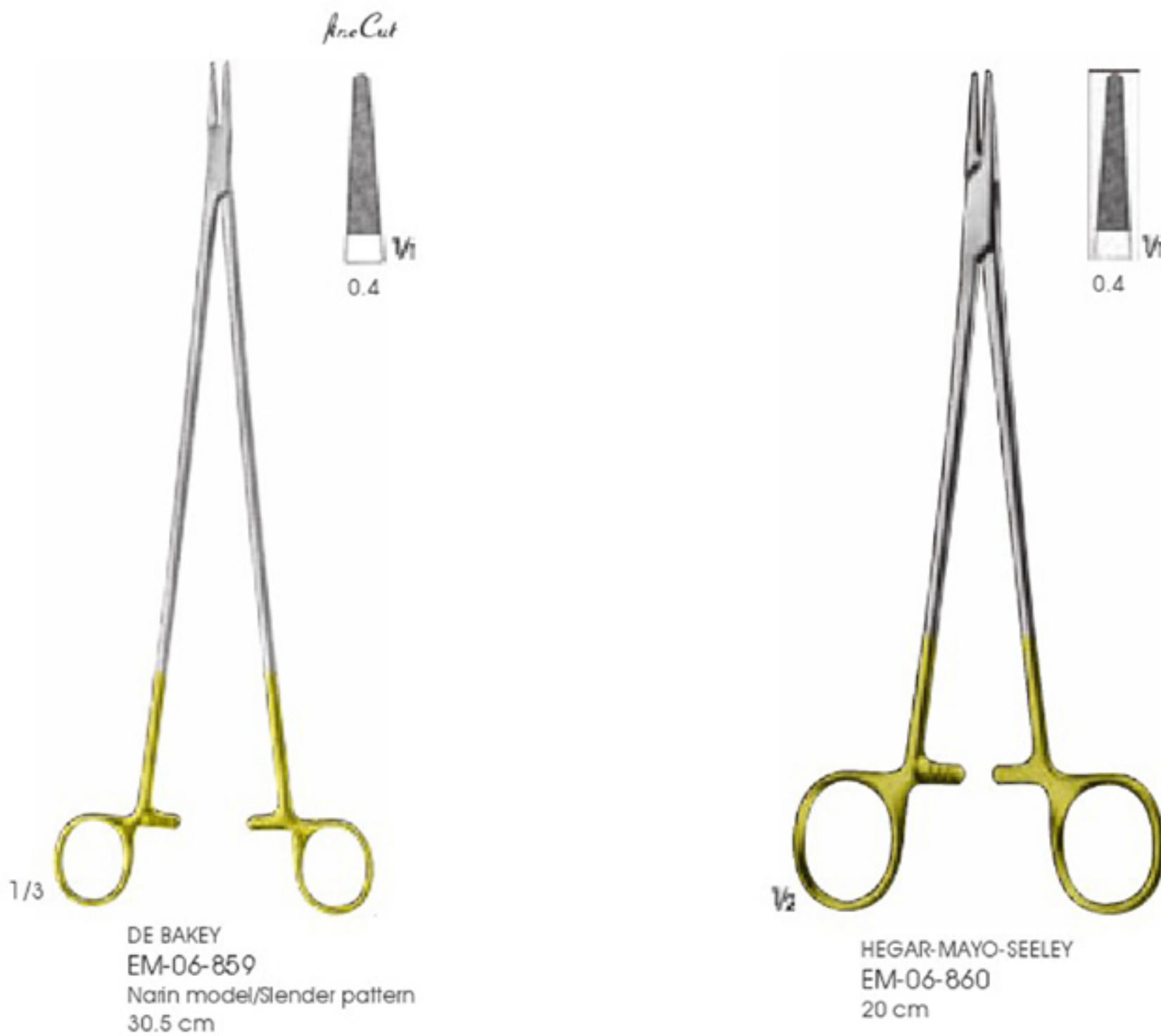
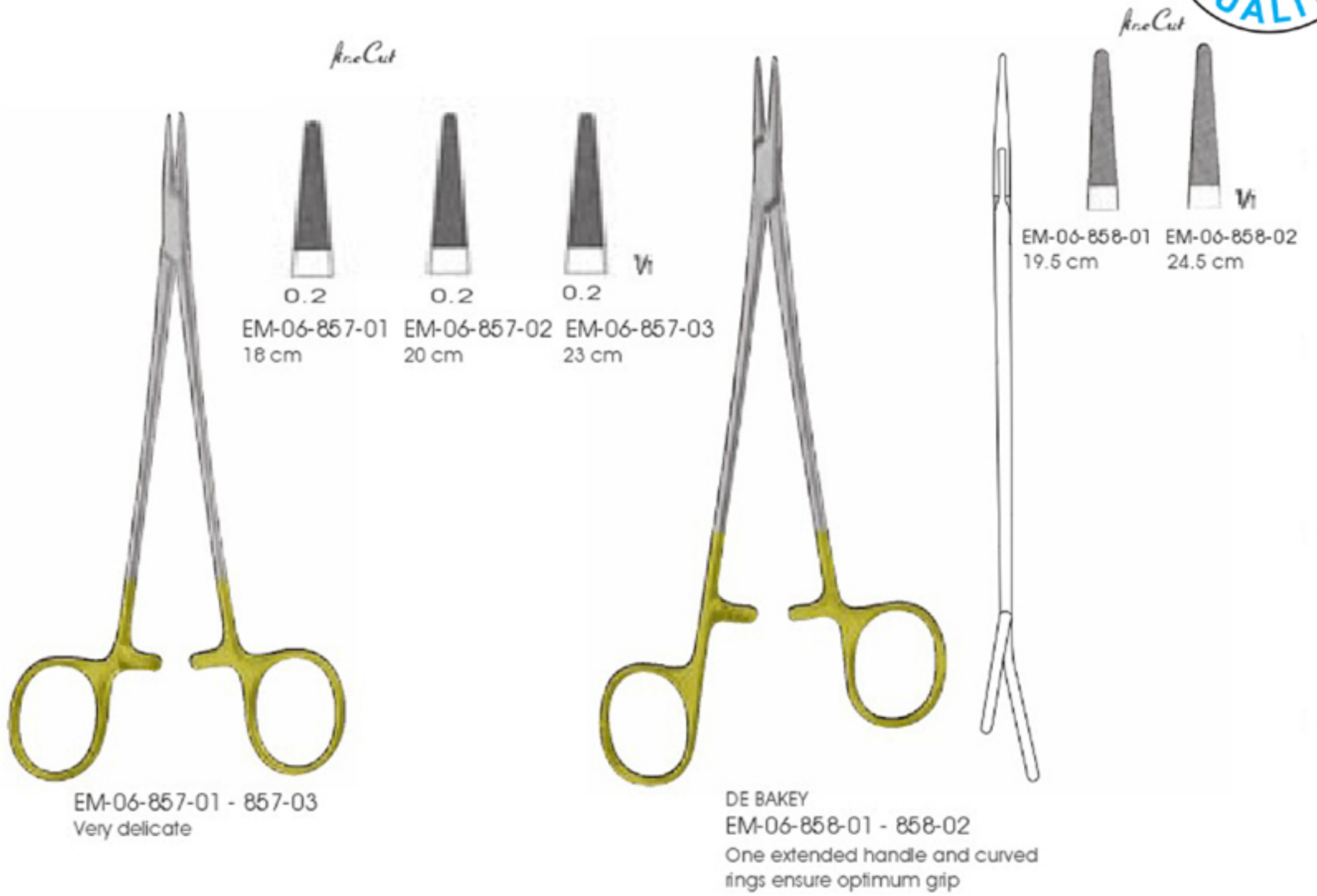



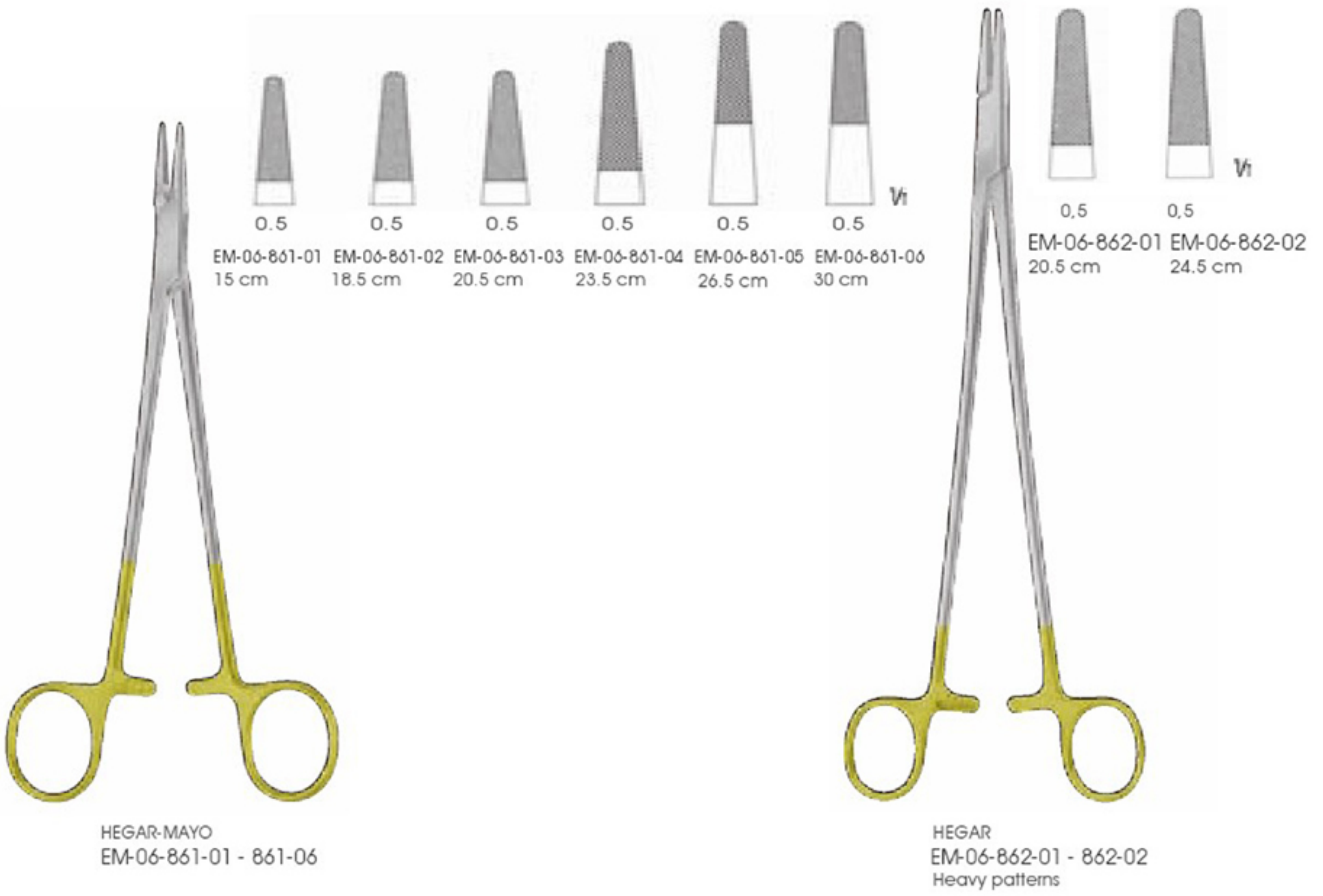



EM-06-863  
12.5 cm



HEGAR-HELSON  
EM-06-864  
14.5 cm

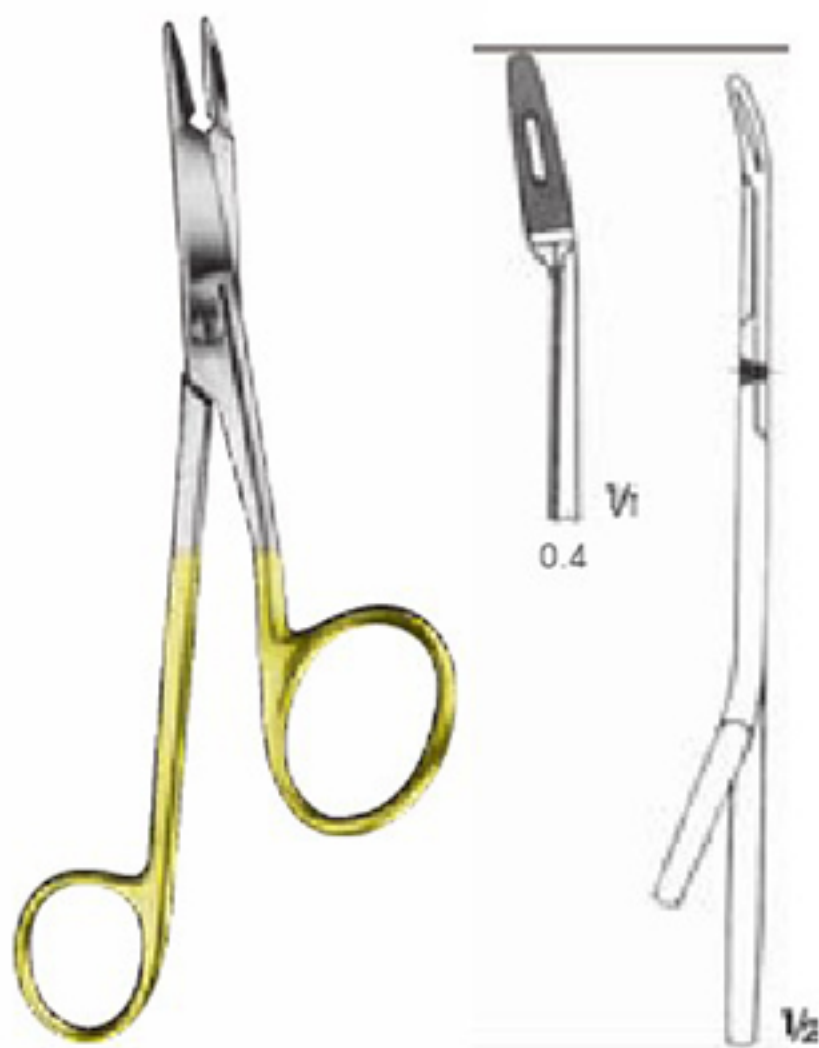

GILLIES  
EM-06-865  
16 cm

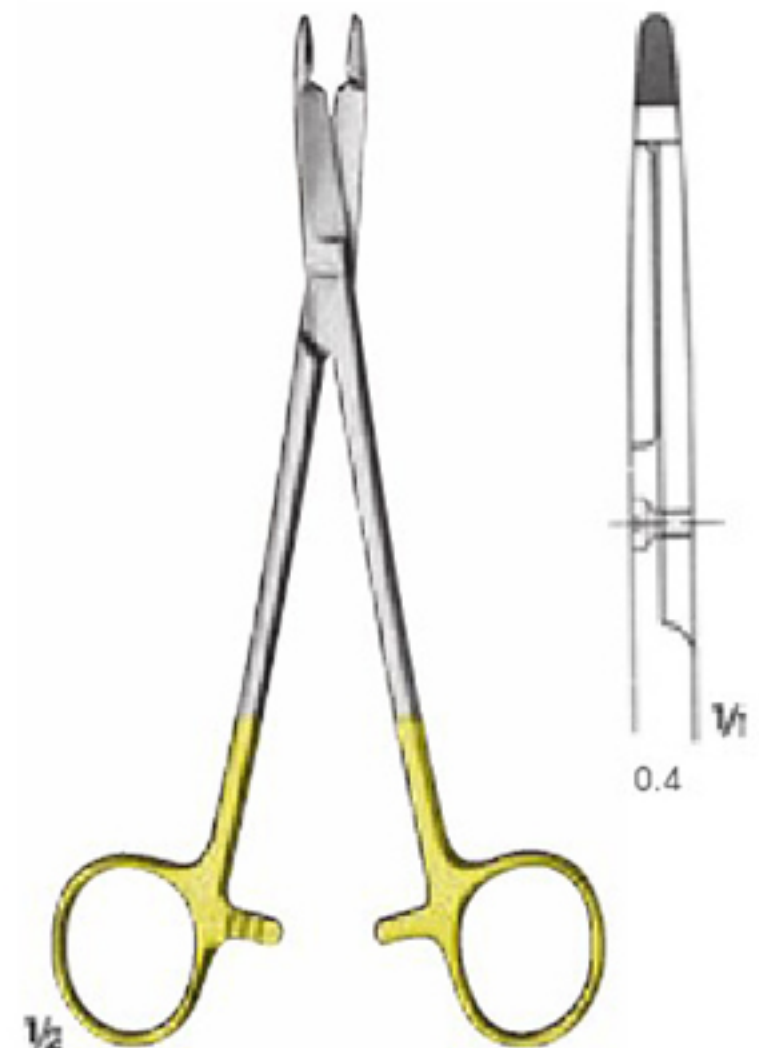

HEGAR-OLSEN  
EM-06-866  
one blade fine serrated  
16.5 cm

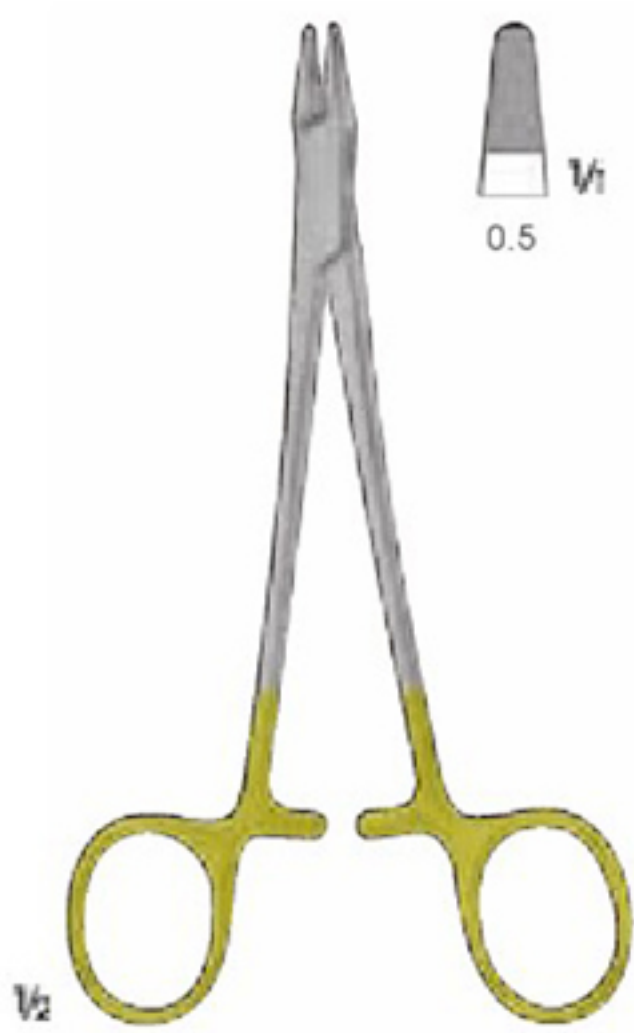

EM-06-867  
 Wire twister  
 15 cm



EM-06-868  
 Wire twister  
 15 cm

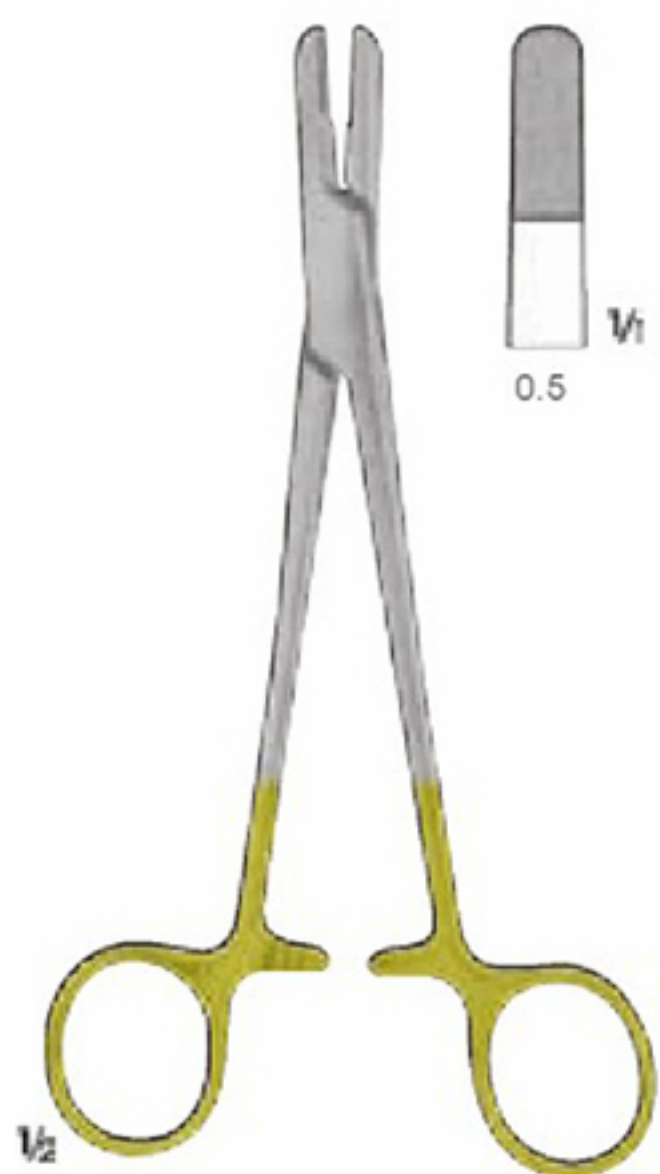

EM-06-869  
 Sternum suture for ligature forceps  
 17.5 cm

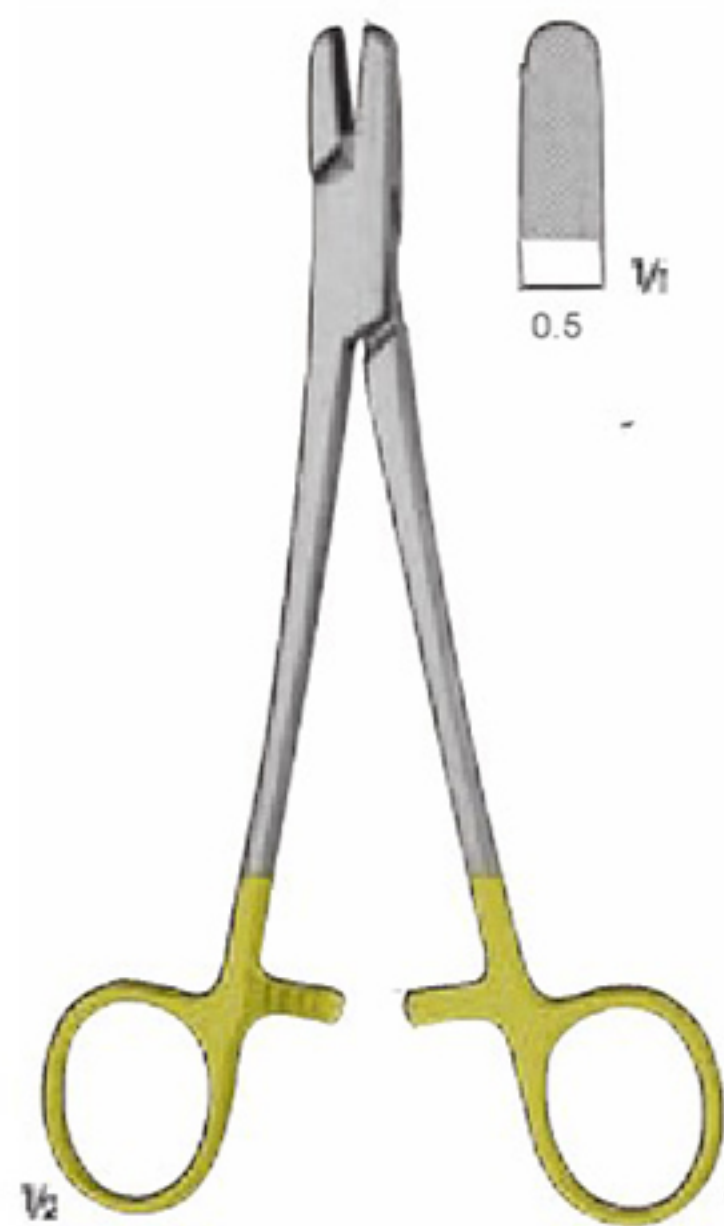

BERRY  
 EM-06-870  
 Wire twister  
 Ligature forceps  
 18.5 cm



BAUMGARTNER  
 EM-06-871  
 Wire twister  
 Ligature forceps  
 20 cm



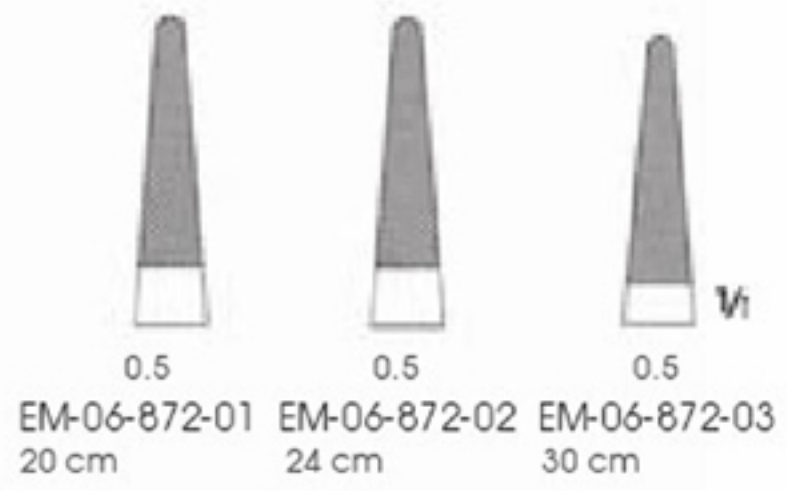
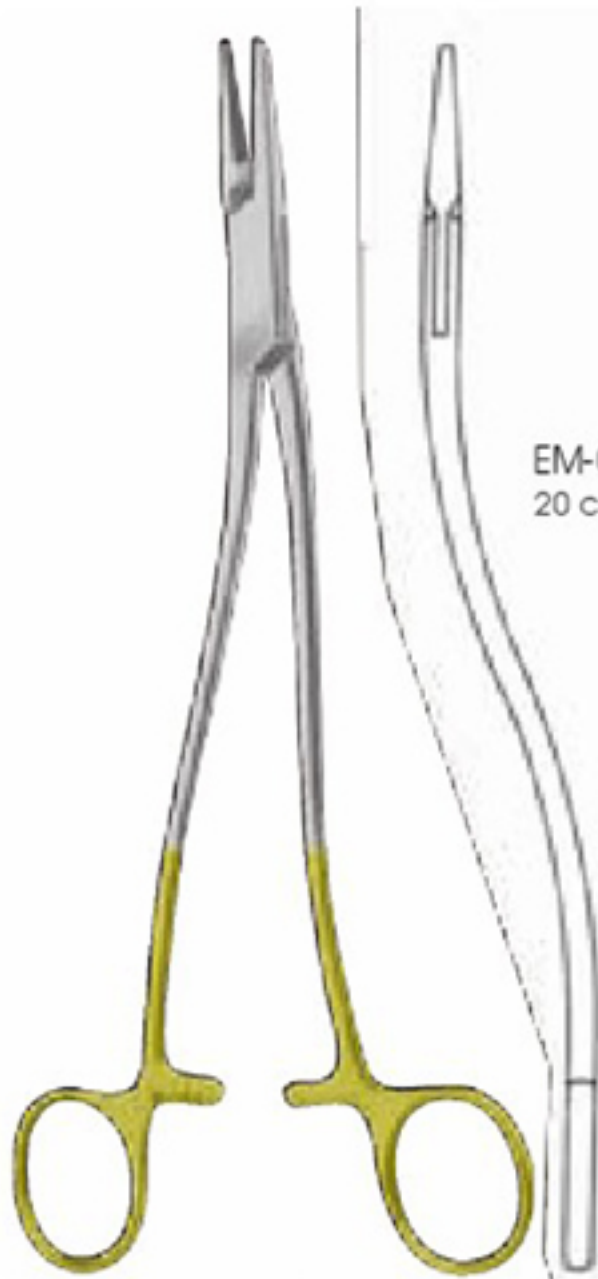

WERTHEIM  
EM-06-872-01 - 872-03

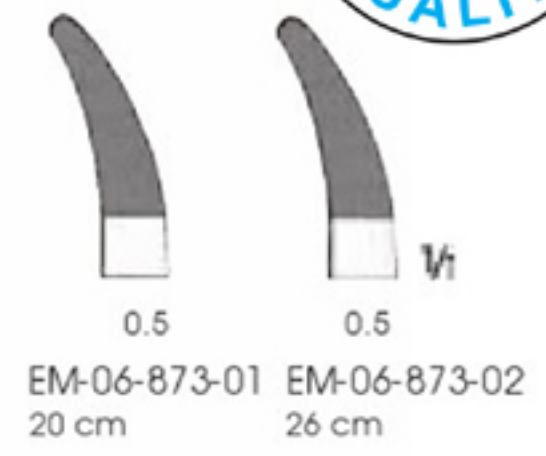
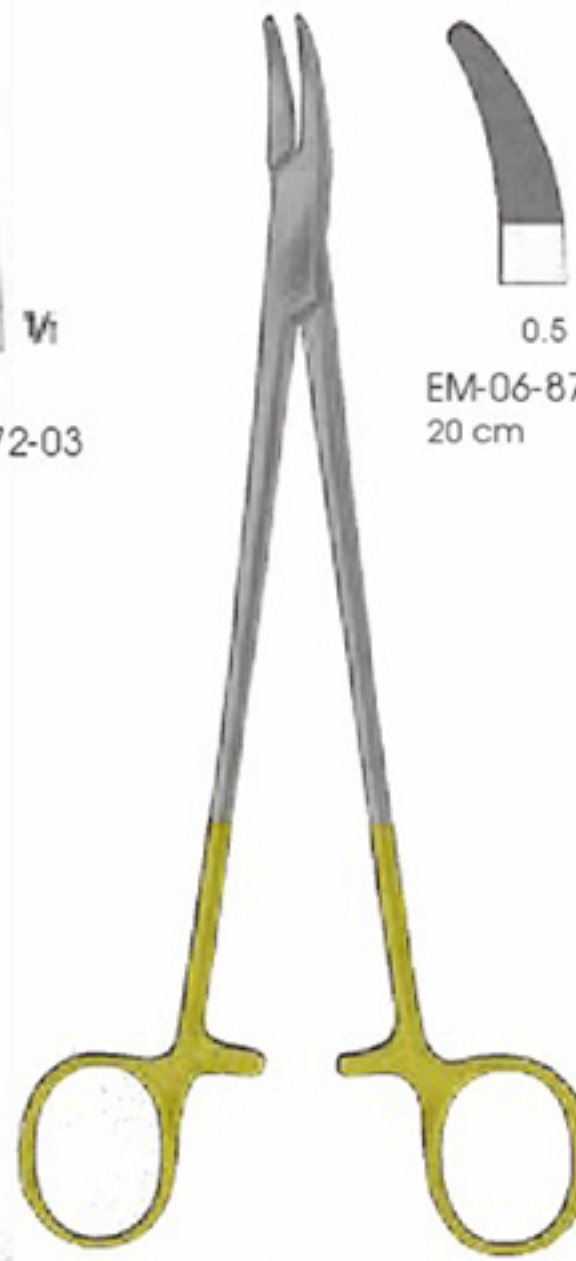

HEANEY  
EM-06-873-01 - 873-02

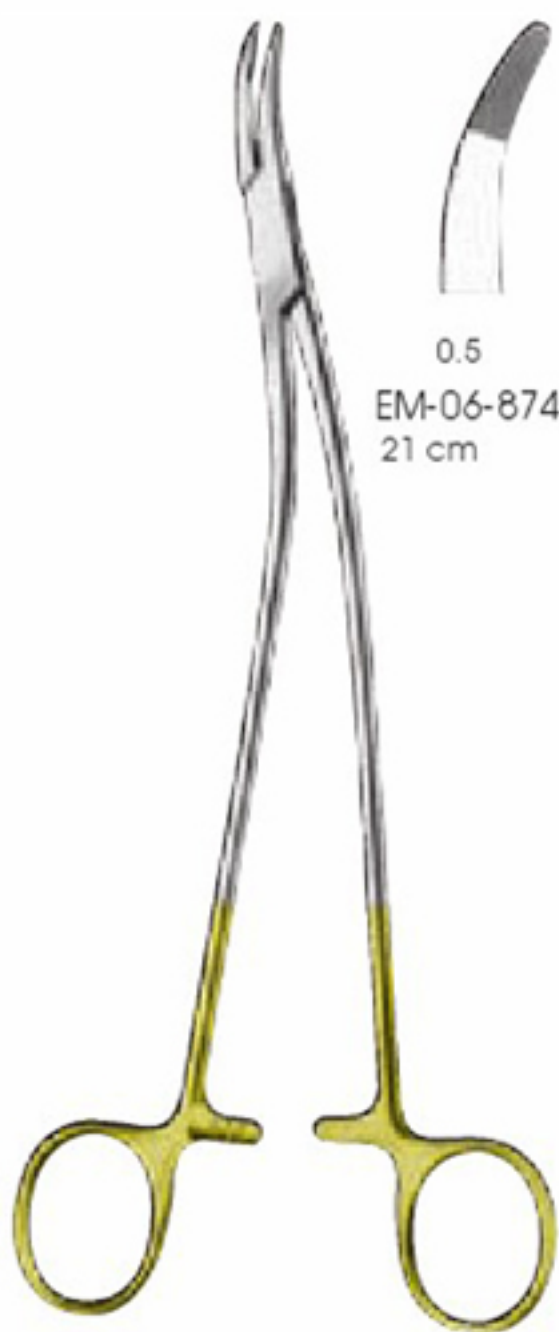

STRATTE  
EM-06-874-01 - 874-02

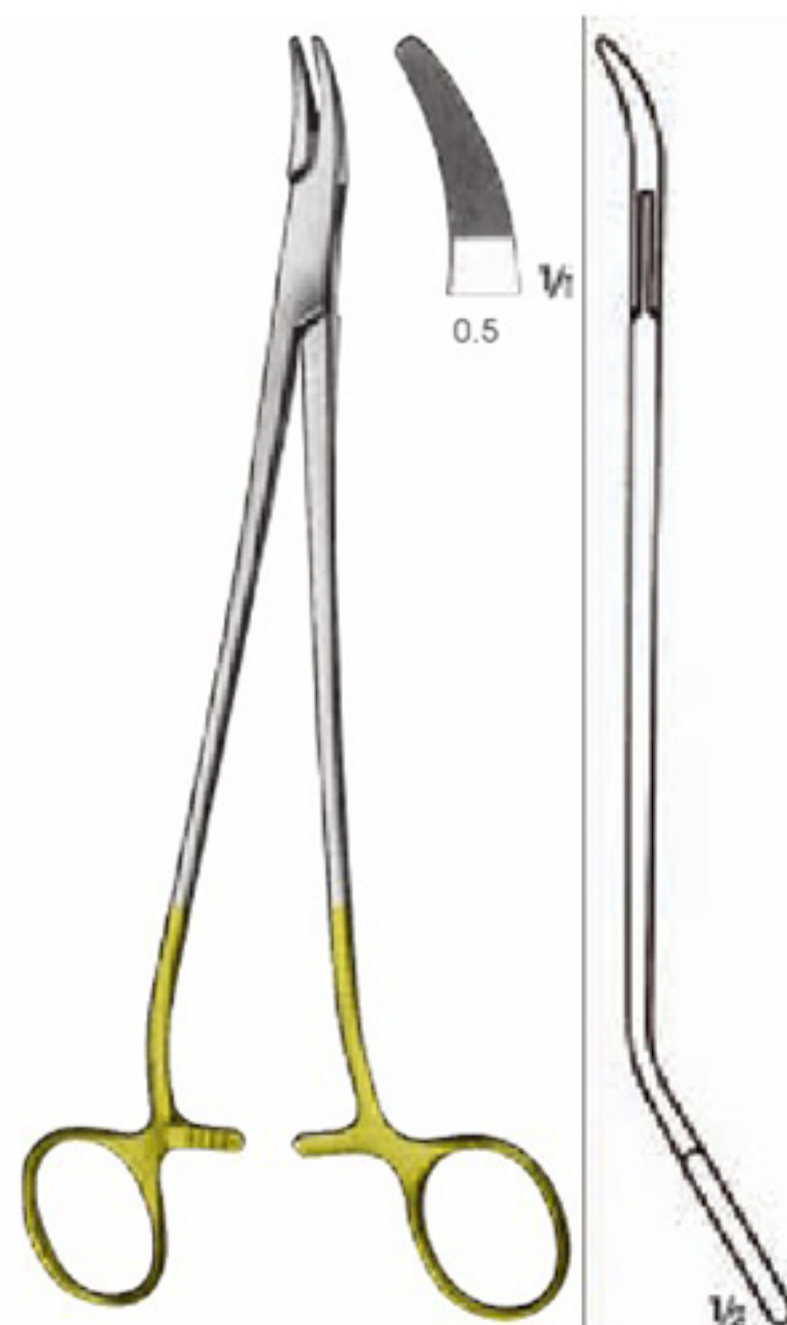

EM-06-875  
S-shaped needle  
21.5 cm



MASSON  
EM-06-876  
26.5 cm



WANGENSTEEN  
EM-06-877  
27.5 cm



EM-06-878  
27.5 cm



$\frac{1}{2}$   
FINOCHIETTO  
EM-06-879  
26.5 cm



$\frac{1}{2}$   
NAUNTUN-MORGAN  
EM-06-880



$\frac{1}{2}$   
EM-06-881  
For deep rectum surgery  
36 cm



- Fine jaws are suitable for gripping non-traumatic needles and vein needles.

*FineCut*



RYDER  
EM-06-882-01 - 882-05  
Very delicate



RYDER  
EM-06-883-01 - 883-04



RYDER  
EM-06-884-01 - 884-03  
With smooth jaws



EM-06-885-01  
18 cm



EM-06-885-02  
20 cm



- Provides maximum ergonomic comfort to surgeon.
- Due to optimized design, it provides fatigue free working on suture and anastomosis techniques.

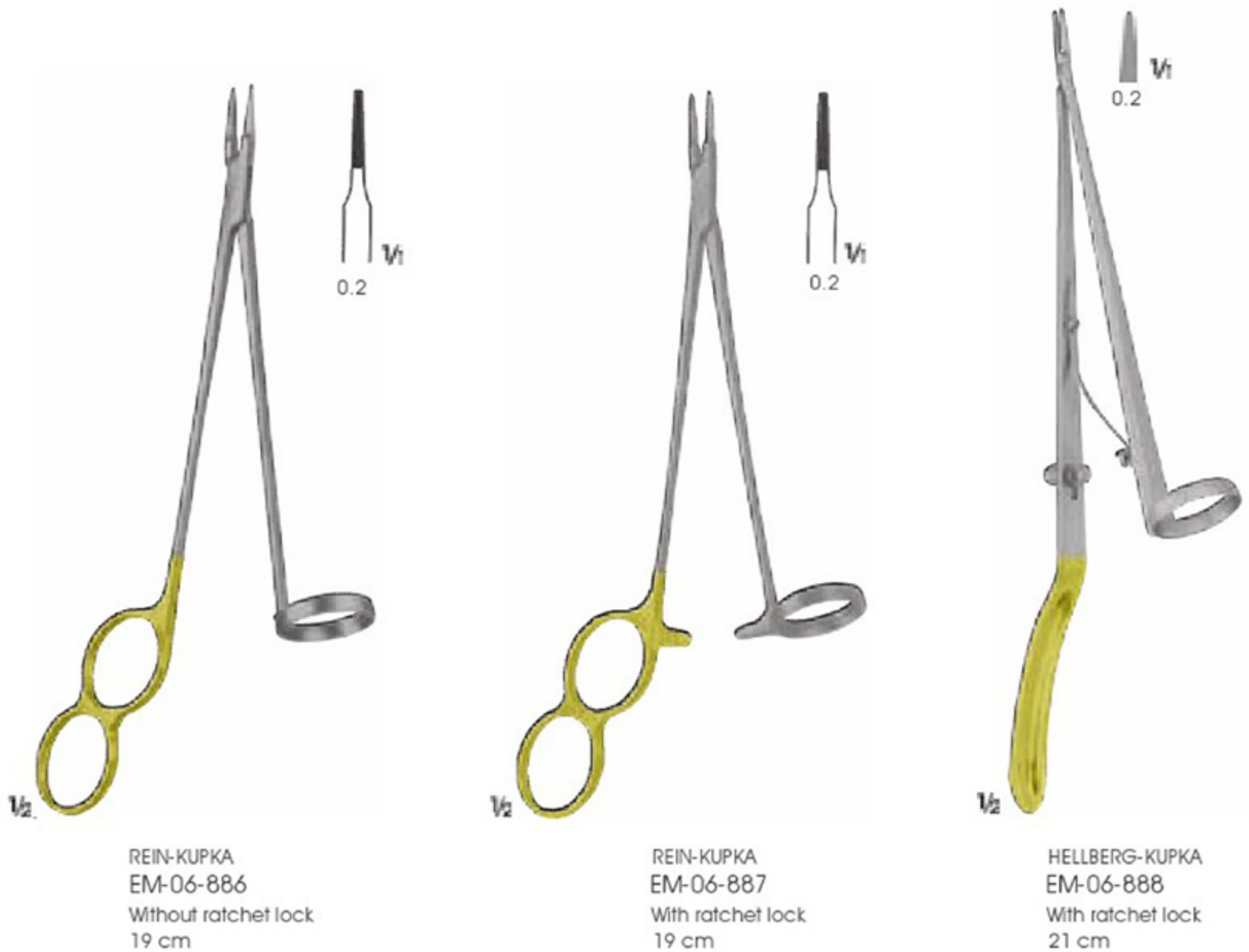



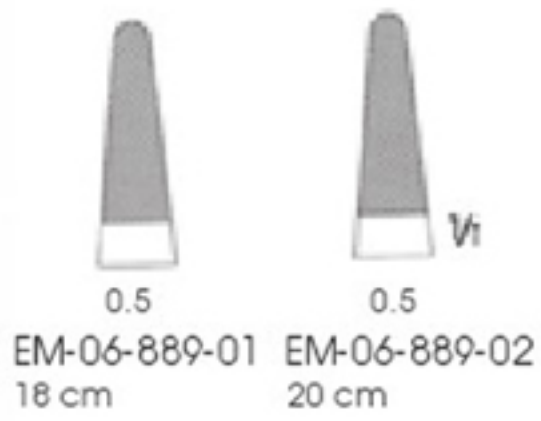

LANGENBECK  
EM-06-889-01 - 889-02



LANGENBECK  
EM-06-890  
Elastic pattern  
20 cm



EM-06-891  
Elastic pattern  
18 cm



EM-06-892  
Elastic pattern  
18 cm

*AcroCut*

0.4  
EM-06-893-01 14 cm

0.4  
EM-06-893-02 17 cm

0.4  
EM-06-893-03 20 cm

MATHIEU  
EM-06-893-01 - 893-03  
Delicate patterns

0.5  
EM-06-894-01 14 cm

0.5  
EM-06-894-02 17 cm

0.5  
EM-06-894-03 20 cm

MATHIEU  
EM-06-894-01 - 894-03  
Standard patterns

0.5  
EM-06-895-01 20 cm

0.5  
EM-06-895-02 24.5 cm

MATHIEU  
EM-06-895-01 - 895-02  
Heavy patterns

0.4  
EM-06-896  
With long neck  
20.5 cm

*AcroCut*

0.5  
EM-06-897  
Elastic pattern  
19.5 cm

LICHTENBERG  
EM-06-897  
Elastic pattern  
19.5 cm

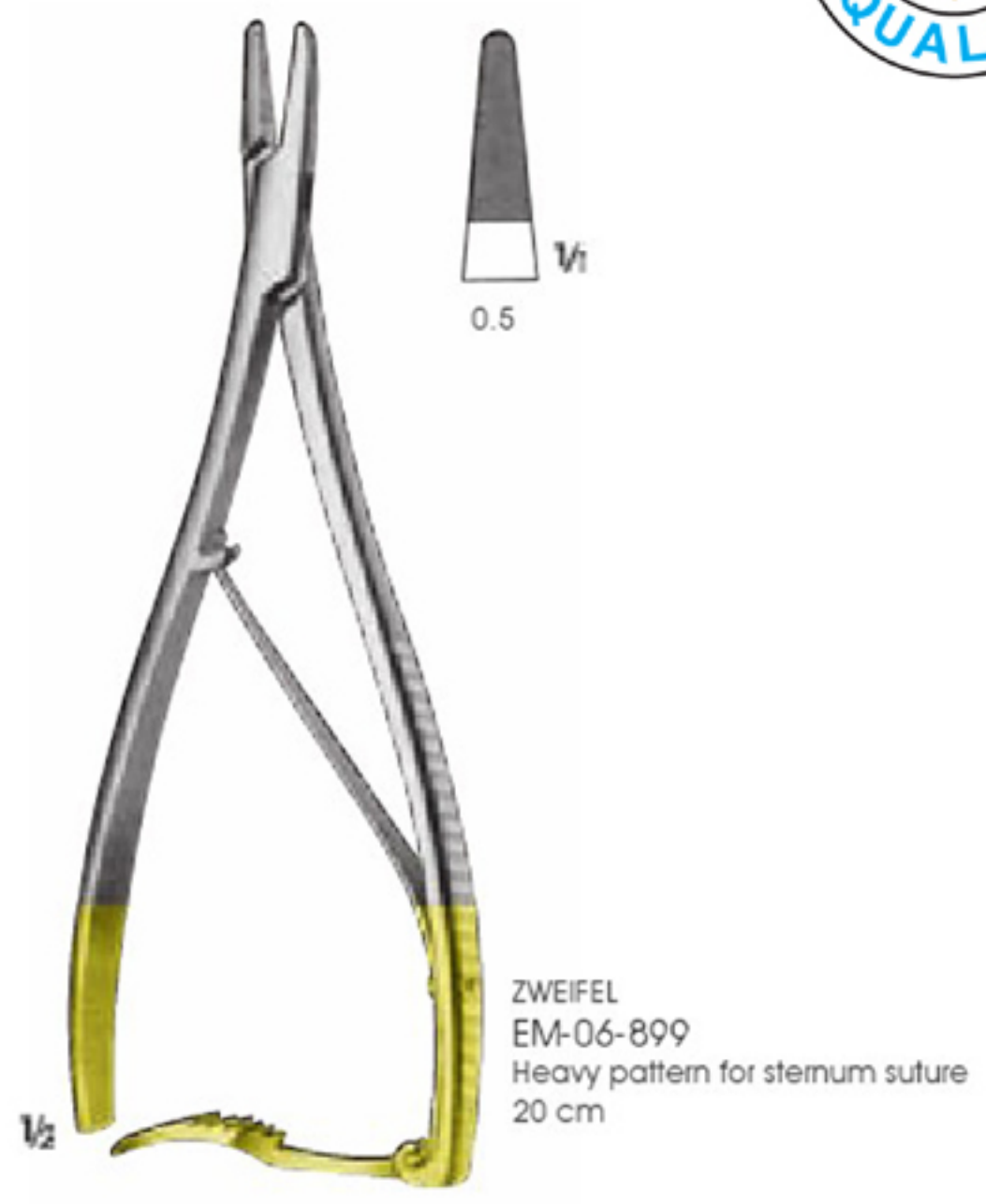





V<sub>2</sub>

YOUNG-HRYNTSCHAK  
EM-06-904  
With 1 needle F 400.00  
24 cm



V<sub>1</sub>

EM-06-903-01



V<sub>1</sub>

EM-06-903-02



V<sub>1</sub>

EM-06-903-03



V<sub>2</sub>

MILLIN  
EM-06-905  
Ligature holding forceps  
28.5 cm

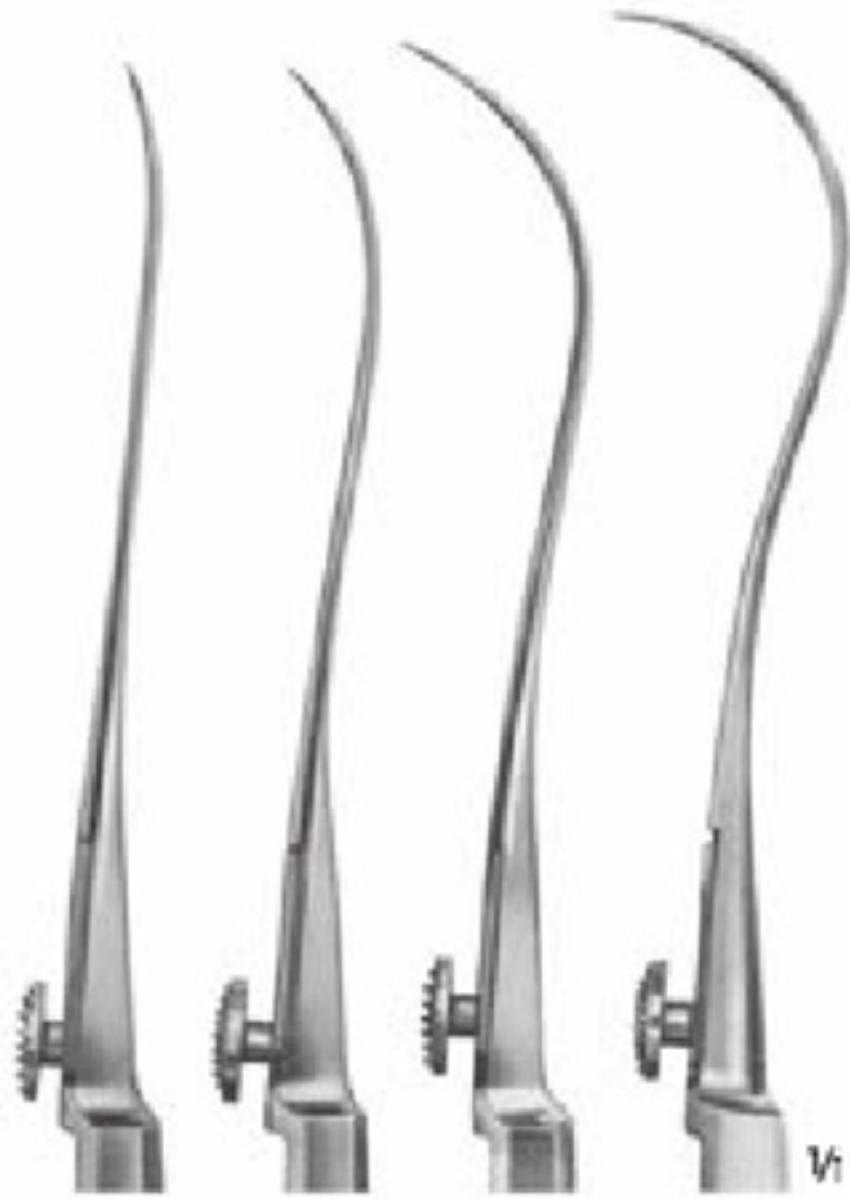

EM-06-906-01 EM-06-906-02 EM-06-906-03 EM-06-906-04



EM-06-907-01 EM-06-907-02 EM-06-907-03 EM-06-907-04



REVERDIN  
EM-06-906-01 - 906-04 19.5 cm  
EM-06-907-01 - 907-04 22 cm

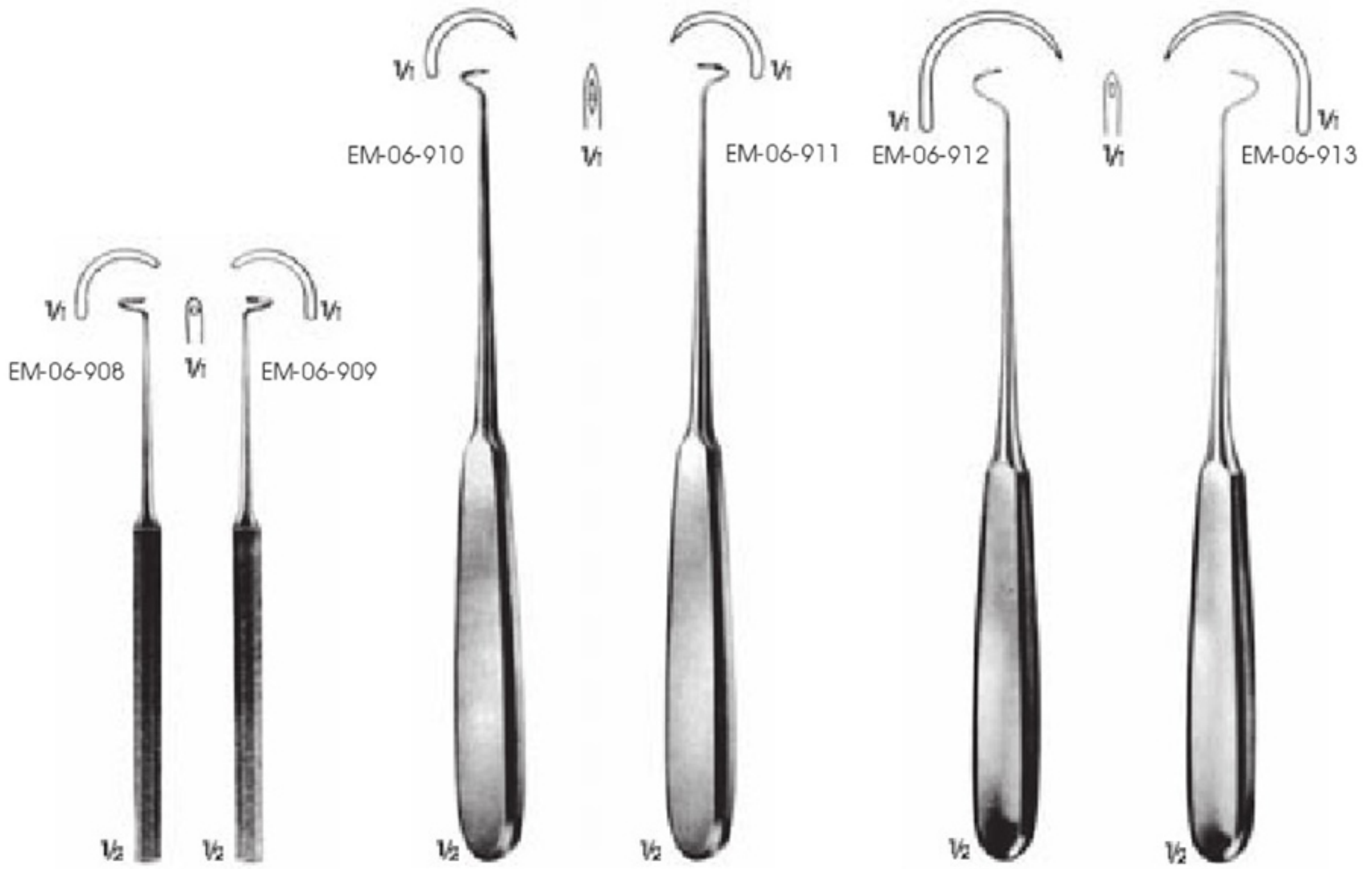

KRONECKER  
EM-06-908  
For right hand blunt  
EM-06-909  
For left hand blunt  
15.5 cm

DESCHAMPS  
EM-06-910  
For right hand sharp  
EM-06-911  
For left hand sharp  
21 cm

HURD  
EM-06-912  
For right hand sharp  
EM-06-913  
For left hand sharp  
21 cm



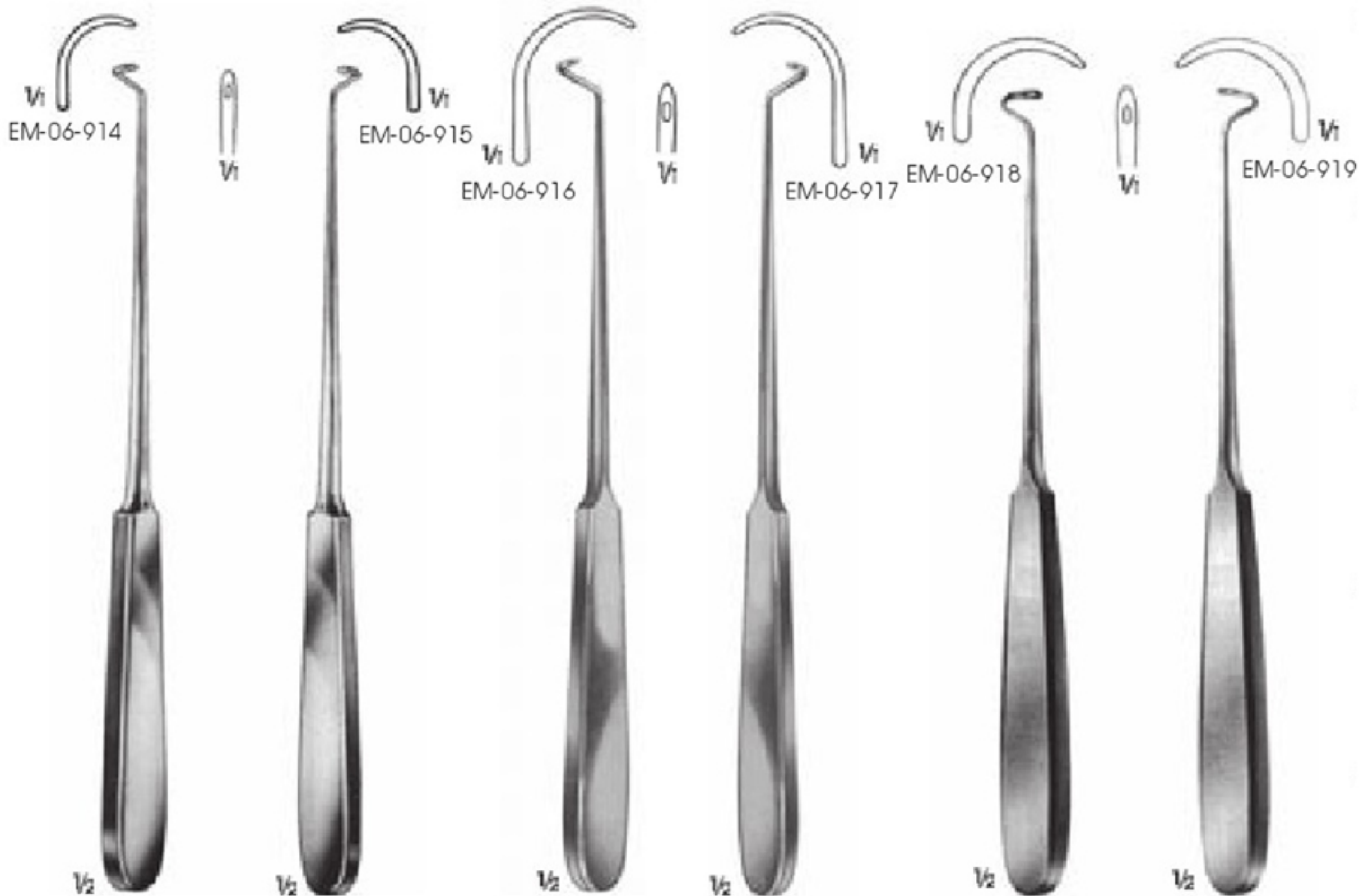

DESCHAMPS  
EM-06-914  
For right hand blunt  
EM-06-915  
For left hand blunt  
22.5 cm

DESCHAMPS  
EM-06-916  
For right hand blunt  
EM-06-917  
For left hand blunt  
22.5 cm

DESCHAMPS  
EM-06-918  
For right hand blunt  
EM-06-919  
For left hand blunt  
21.5 cm

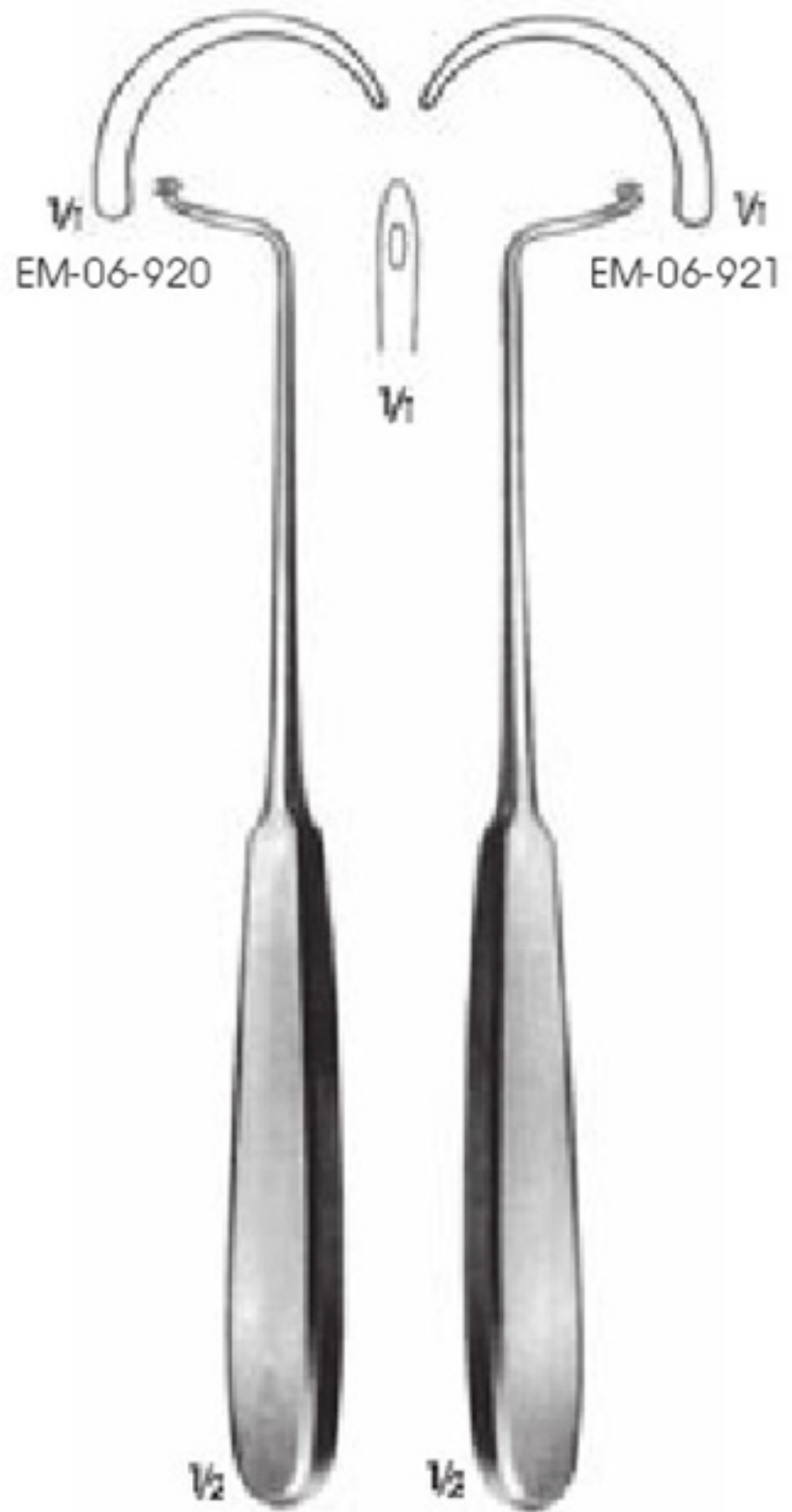

DESCHAMPS  
EM-06-920  
For right hand blunt  
EM-06-921  
For left hand blunt  
21 cm

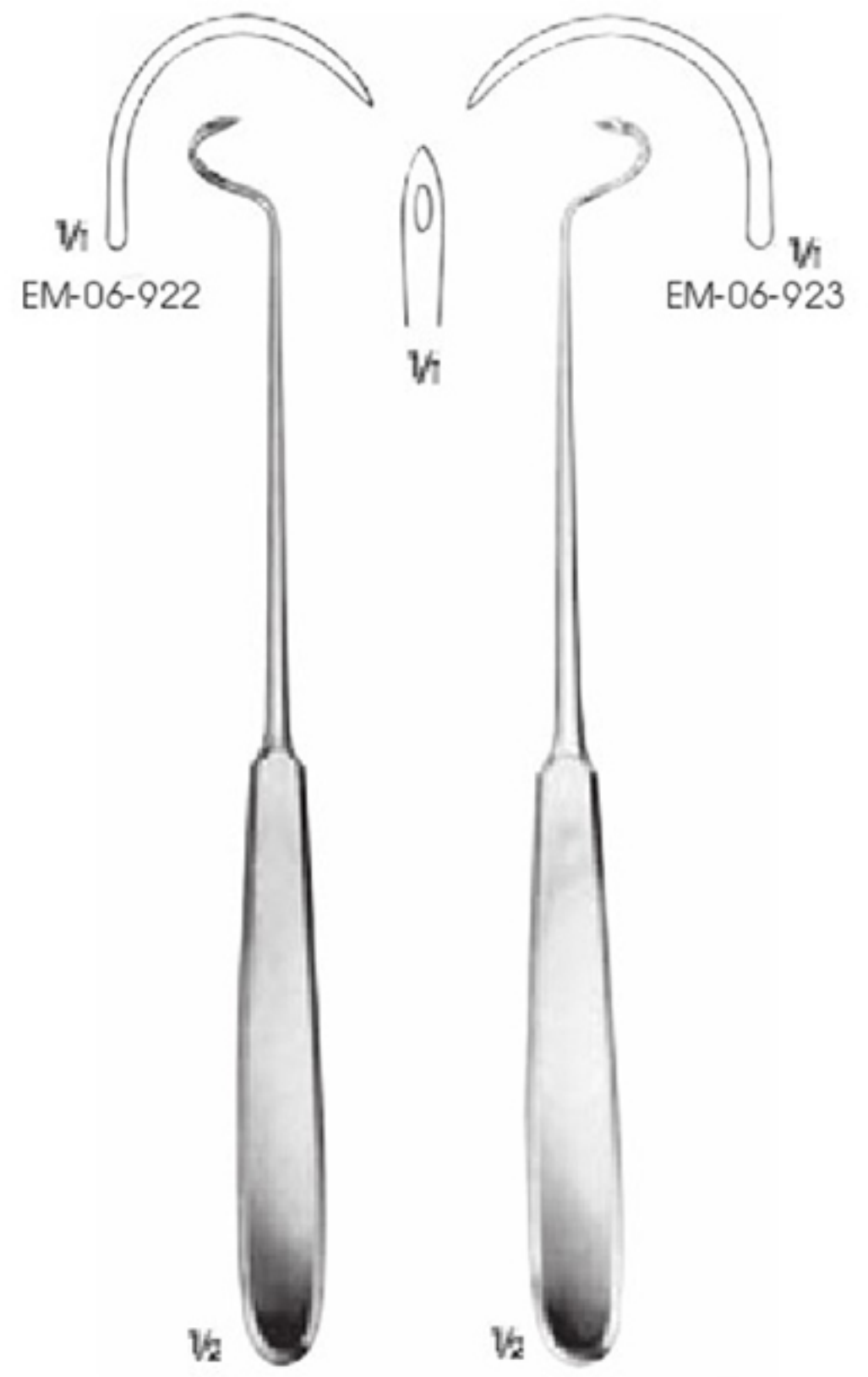

DESCHAMPS  
EM-06-922  
For right hand blunt  
EM-06-923  
For left hand blunt  
21.5 cm

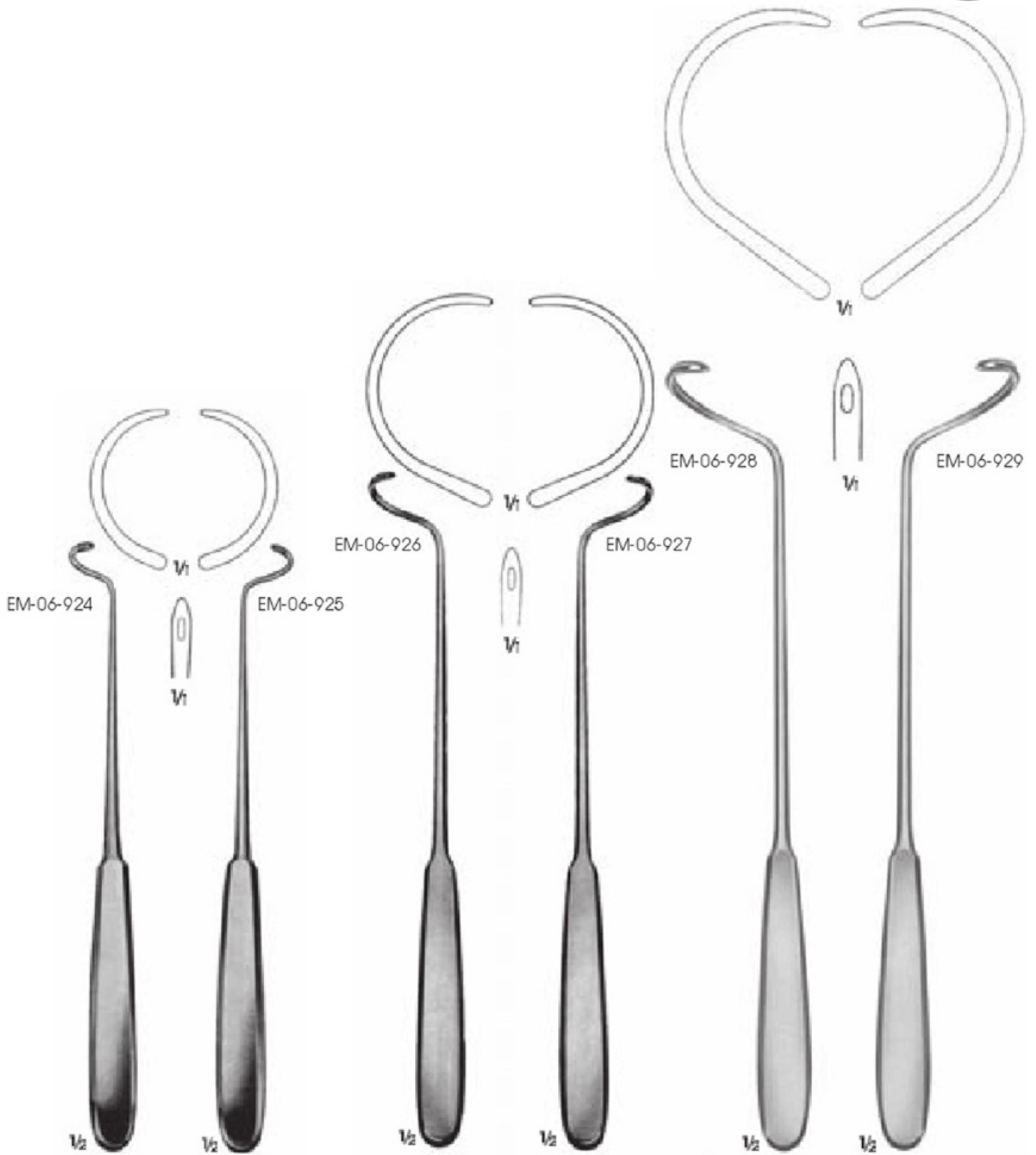

DESCHAMPS  
EM-06-924  
For right hand blunt  
EM-06-925  
For left hand blunt  
21.5 cm

DESCHAMPS  
EM-06-926  
For right hand blunt  
EM-06-927  
For left hand blunt  
24 cm

DESCHAMPS  
EM-06-928  
For right hand blunt  
EM-06-929  
For left hand blunt  
28 cm



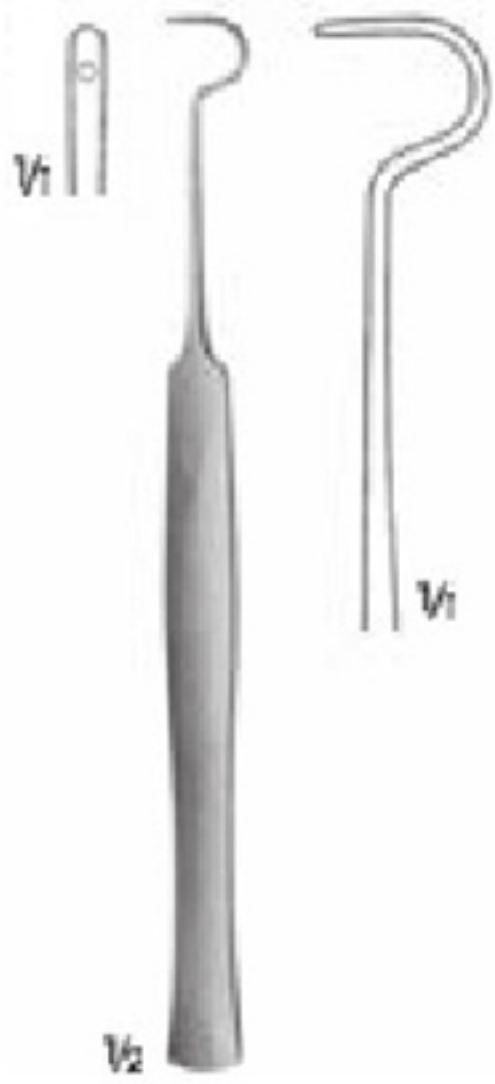

EM-06-930  
15 cm



SYME  
EM-06-931  
17 cm



JONESCO  
EM-06-932  
Needle for wire suture  
18.5 cm

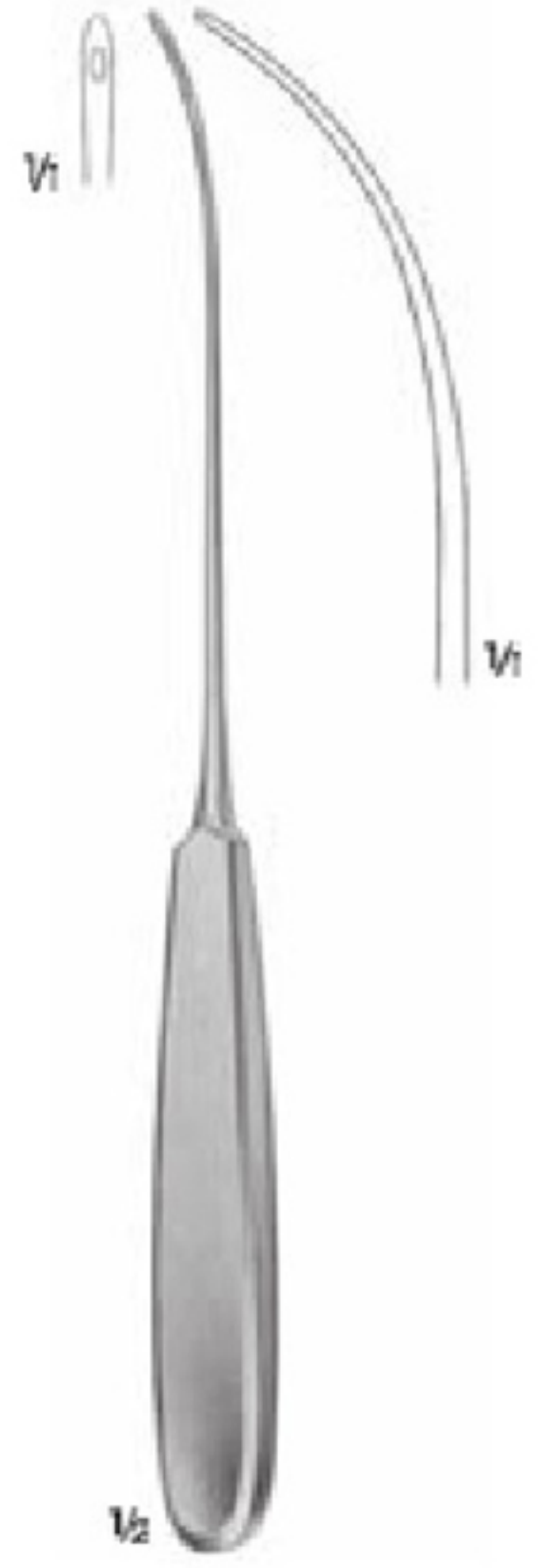

EM-06-933  
Malleable  
23 cm



CLAUS VAN EICKEN  
EM-06-934  
25 cm

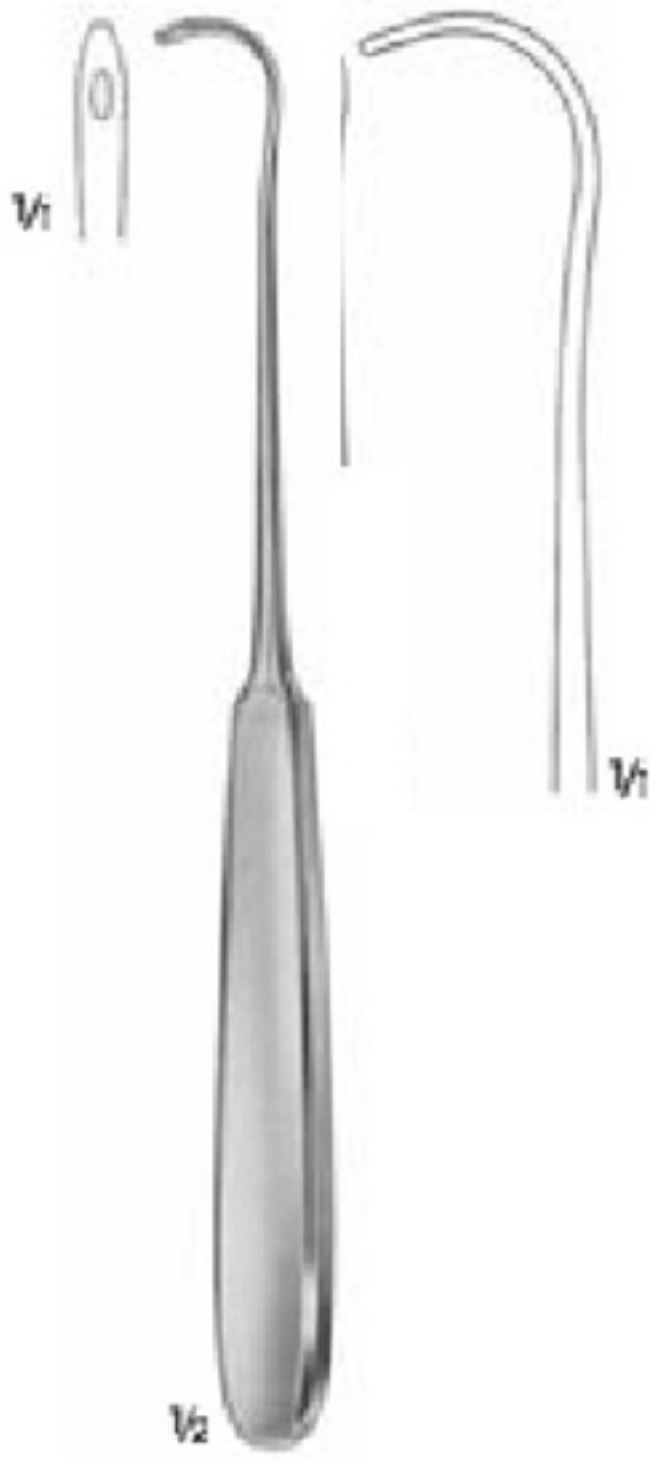

COOPER  
EM-06-935  
20.5 cm

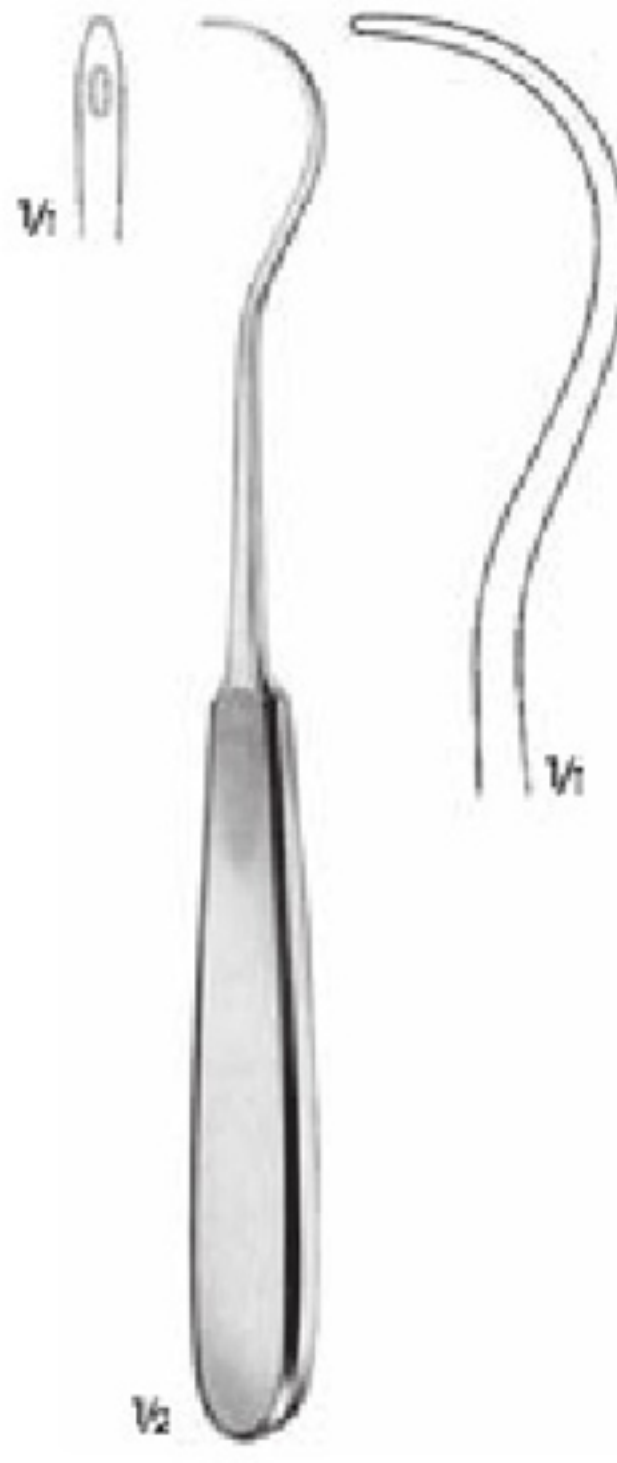

KOCHER  
EM-06-936  
20.5 cm



BRUNNER  
EM-06-937  
24 cm



EM-06-938-01



EM-06-938-02



EM-06-939-01



EM-06-939-02

1/2

BRUNNER  
EM-06-938-01 - 938-02  
Guiding probes  
30 cm

1/2

BRUNNER  
EM-06-939-01 - 939-02  
Ligature needles  
30 cm



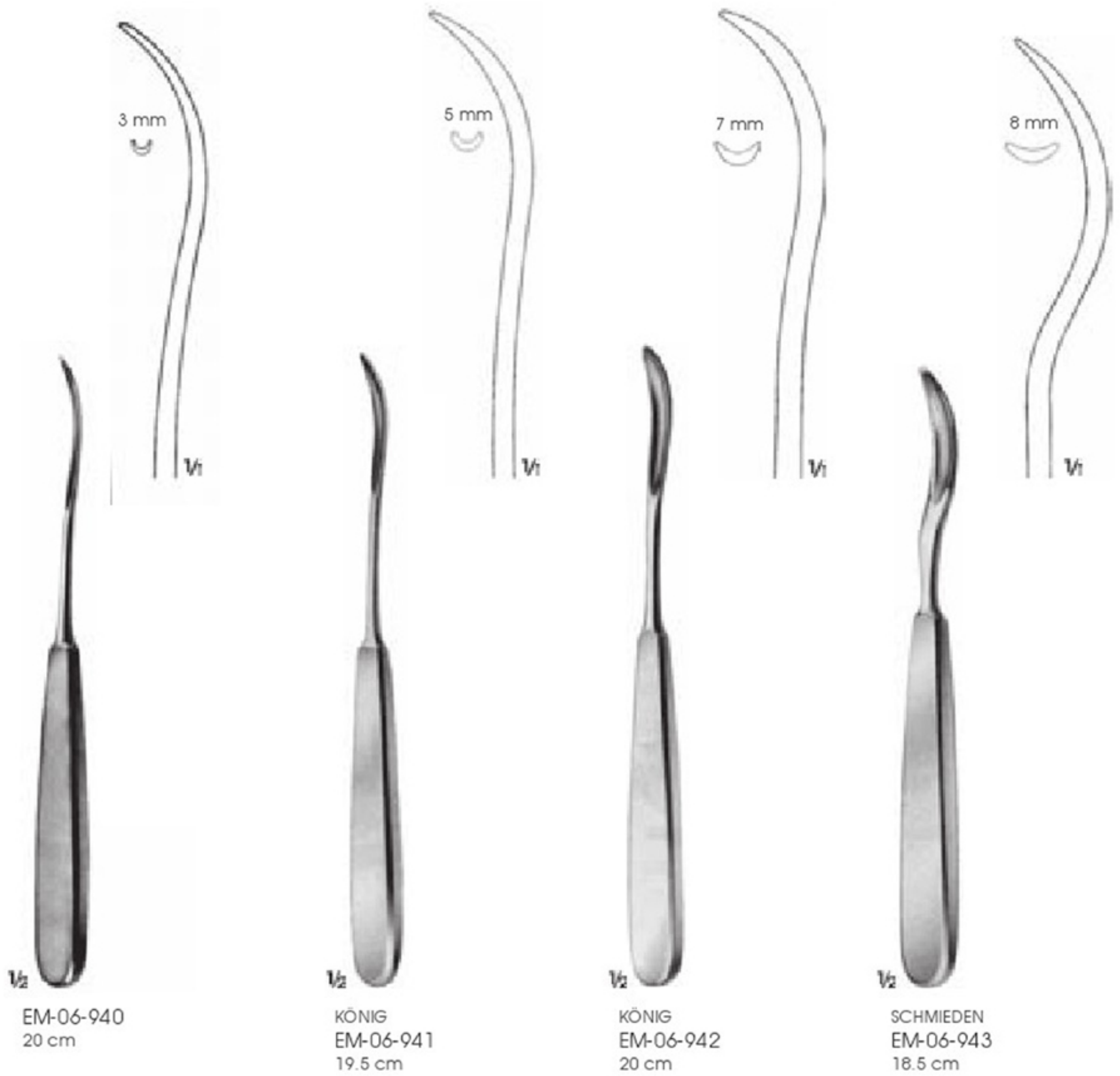



1/2

KOCHER  
EM-06-944  
15 cm

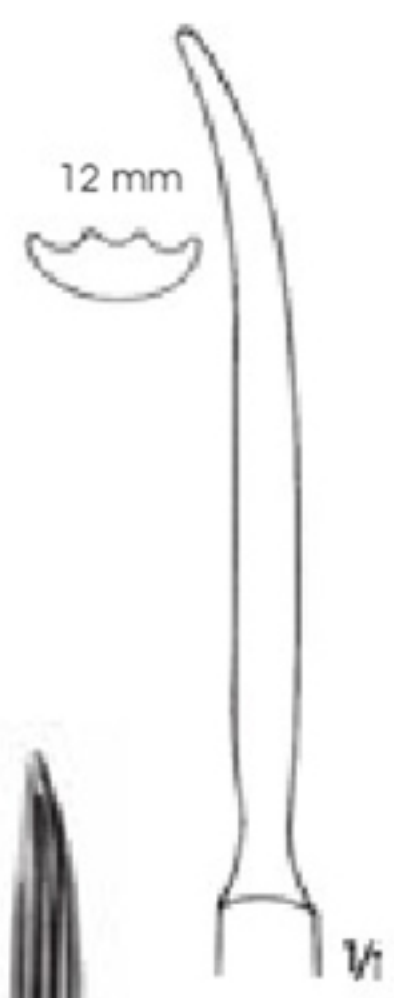

1/2

KOCHER  
EM-06-945  
17 cm



1/2

PAYR  
EM-06-946  
19.5 cm



1/2

PAYR  
EM-06-947  
22.5 cm

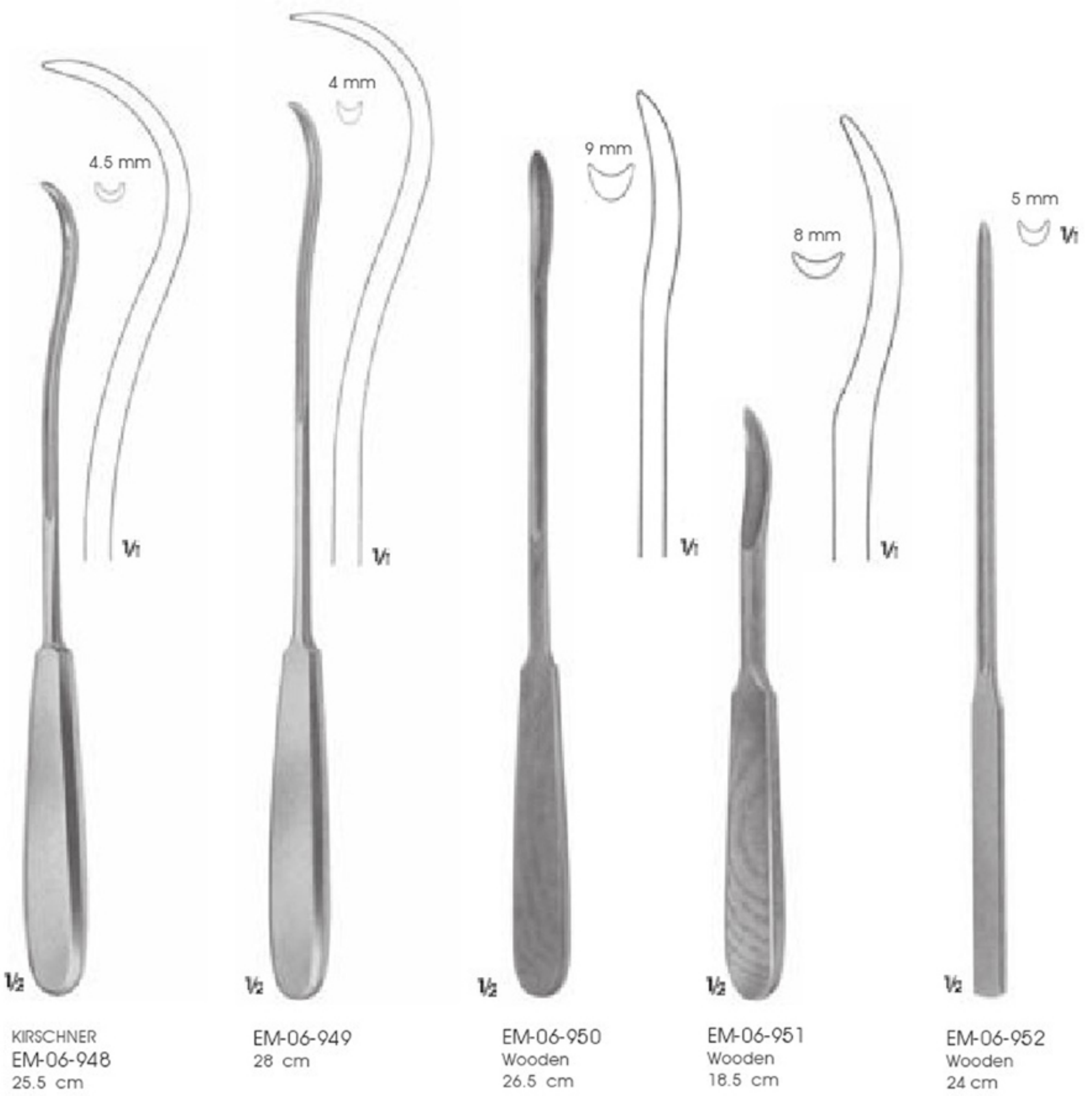





$\frac{1}{2}$   
 HEGENBARTH  
 EM-06-953  
 Clip applying forcep  
 12 cm



$\frac{1}{2}$   
 MICHEL  
 EM-06-954  
 Clip applying forcep  
 12.5 cm



$\frac{1}{2}$   
 MICHEL  
 EM-06-955  
 Clip applying and removing forcep  
 12.5 cm



$\frac{1}{2}$   
 MICHEL  
 EM-06-956  
 Clip applying and removing forcep  
 13 cm



$\frac{1}{2}$   
 EM-06-959  
 Attachment node  
 23 cm



$\frac{1}{2}$   
 CASPAR  
 EM-06-960  
 Attachment node  
 23 cm



$\frac{1}{2}$   
 COLLIN  
 EM-06-957  
 Clip removing forcep  
 13.5 cm



$\frac{1}{2}$   
 HEATH  
 EM-06-958  
 Clip removing forcep  
 13.5 cm

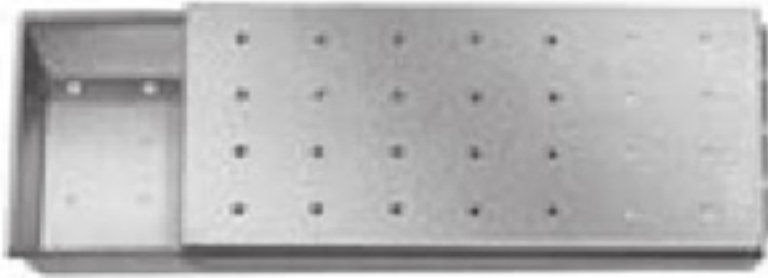

EM-06-961-01  
50 x 25 x 5 mm  
EM-06-961-02  
50 x 30 x 6 mm  
EM-06-961-03  
70 x 25 x 5 mm

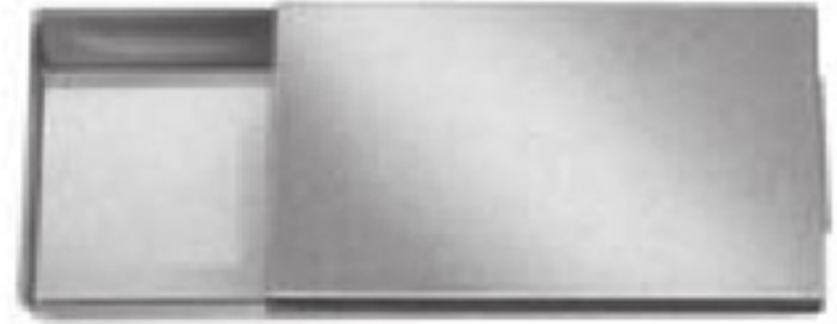

EM-06-962-01  
60 x 25 x 11 mm  
EM-06-962-02  
70 x 53 x 9 mm



EM-06-963  
150 x 90 x 10 mm



EM-06-964  
205 x 120 x 12 mm



EM-06-965 65 x 16 mm Needle case with interior box  
EM-06-966 95 x 16 mm Needle case with interior box  
EM-06-967 65 x 16 mm Exterior box of F 960.00  
EM-06-968 62 x 17 mm Interior box of F 960.00 only  
EM-06-969 90 x 17 mm Interior box of F 960.00 only