



Heamostatic And Dissecting Forceps

Hämostatische und zergliedernde Zange

For temporary occlusion :
 Safe and careful gripping of vessel
 Blades with serrated surface and rigidly fixed pressure feature
 Closing force is measured at 1/3 of the blades a 1 mm opening



BIEMER
 EM-07-970
 Length of jaws 6 mm
 Opening 4 mm
 Closing force 30-40 gr. (0.29 - 0.39 N)



EM-07-971
 Length of jaws 9 mm
 Opening 5 mm
 Closing force 30-40 gr. (0.29 - 0.39 N)



BIEMER
 EM-07-972
 Length of jaws 9 mm
 Opening 5 mm
 Closing force 20-25 gr. (0.20 - 0.25 N)



for vessel Ø 0.5 - 2.0 mm.
 S 034.00 ve S 035.00 ile birlikte kullanılır.

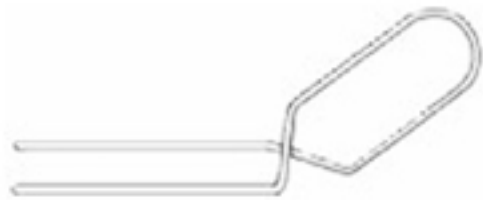

MEHDORN
 EM-07-973-01
 Length of jaws 1 mm
 Opening 4 mm
 Closing force 10-15 gr. (0.10 - 0.15 N)



MEHDORN
 EM-07-973-02
 Length of jaws 1.4 mm
 Opening 4 mm
 Closing force 15-20 gr. (0.15 - 0.20 N)



MEHDORN
 EM-07-973-03
 Length of jaws 1 mm
 Opening 6 mm
 Closing force 10-15 gr. (0.10 - 0.15 N)



MEHDORN
 EM-07-973-04
 Length of jaws 1.4 mm
 Opening 6 mm
 Closing force 15-20 gr. (0.15 - 0.20 N)



for vessel Ø 0.5 - 2.0 mm.
 S 032.00 ile birlikte kullanılır.

For micro vessel anastomosis:
Safe and careful gripping of vessel.
Blades with serrated surface and rigidly fixed pressure feature.
Adjustable distance between clips.
Automatic fixation by tilting



BIEMER-MULLER
EM-07-974
Length of jaws.6 mm
Opening 4 mm
Closing force 30-40 gr.



EM-07-975
Length of jaws.4.5 mm
Opening 3 mm
Closing force 25-30 gr.



EM-07-976
Length of jaws.9 mm
Opening 5 mm
Closing force 25-30 gr.



EM-07-977
Length of jaws.9 mm
Opening 5 mm
Closing force 25-30 gr.



EM-07-978
Length of jaws.9 mm
Opening 5 mm
Closing force 25-30 gr.



EM-07-979
Length of jaws.9 mm
Opening 5 mm
Closing force 25-30 gr.



EM-07-980
Closing force. 25-30 gr.

Ø 1 mm

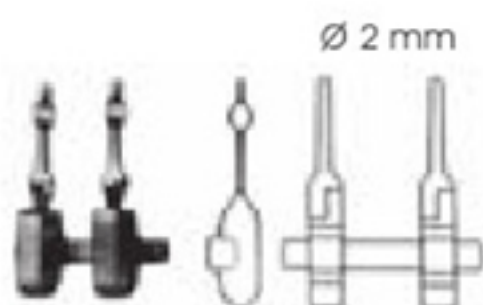

EM-07-981
Closing force. 25-30 gr.

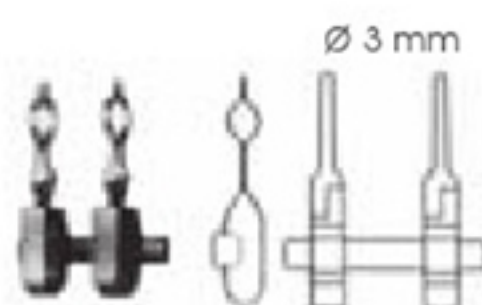

EM-07-982
Closing force. 25-30 gr.

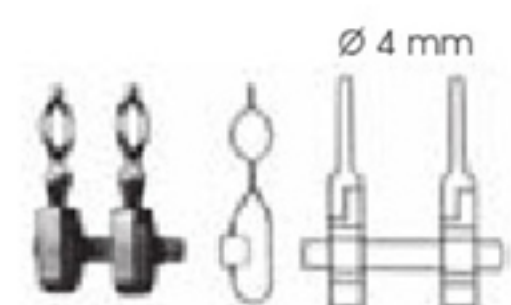

EM-07-983
Closing force. 25-30 gr.



VI
BIEMER
EM-07-984
Without lock



VI
BIEMER
EM-07-985
With lock



VI



VI
BIEMER
EM-07-987
Applying forceps for BIEMER
vessel approximator
14.5 cm



VI

BIEMER
EM-07-986-01
Complete
EM-07-986-02
Approximator only
EM-07-987 Klip penset
Applying Forceps



VI
MEHDORN
EM-07-988
Applying forceps for MEHDORN
vessel clips
15 cm

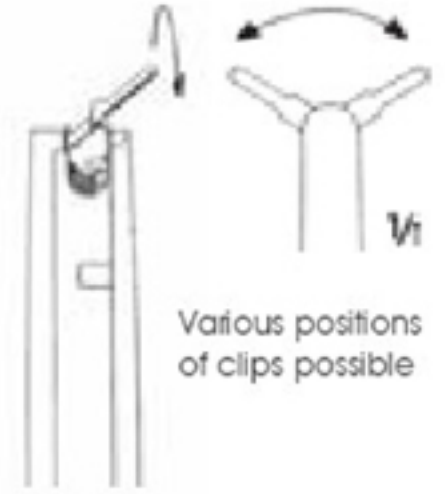

Various positions
of clips possible

BIEMER
EM-07-984 - 985
Applying forceps for BIEMER vessel clips and
BIEMER-MÜLLER and MÜLLER approximators
14 cm



BIEMER
EM-07-989
mator, complete
with key S 029.00

For micro vessel anastomosis

- Safe and careful gripping of vessel.
- Blades with serrated blade surface
- Pressure adjustment with use of key(S 029.00)
- Adjustment of distance between blades and fixation of blades with a use of key(S 029.00)



BIEMER
EM-07-990
Approximator, complete
with key S 029.00

Safe adaptation of nerve anastomoses

- Piercing the nerve center with fine needles that prevents strong pathological changes
- Changeable needles with use of key.(S 029.00)
- Adjustment of distance between needles and fixation of needles with use of key(S 029.00)



EM-07-991
Approximator

For micro vessel anastomosis

- Safe and careful gripping of vessel.
- Blades with serrated blade surface
- The ability to manually set the pressure
Distance, zoom in and out manually.



Jaw profiles, finally
cross-serrated

EM-07-992
Ligature forceps

Non-traumatic Vessel Clips, temporary



EM-07-993-01
Closing Forceps 50 gr/Straight
EM-07-994-01
Closing forceps 80 gr/Straight



EM-07-993-02
Closing forceps 50 gr/Curved
EM-07-994-02
Closing forceps 80 gr/Curved



EM-07-993-03
Closing forceps 50 gr/Curved
EM-07-994-03
Closing forceps 80 gr/Curved



EM-07-993-04
Closing forceps 50 gr/Angled to side
EM-07-994-04
Closing forceps 80 gr/Angled to side



EM-07-993-05
Closing Forceps 50 gr/Knee-bent
EM-07-994-05
Closing Forceps 80 gr/Knee-bent



Features :

- Atraumatic mouth profile.
- Holding plates used on both side of the clips ensure safe application and removal.
- Closing pressure of the clips are exactly defined for arterial and venous vessels.
- Closing pressure of the clips is marked on the clips.



Toothing De Bakey



EM-07-995-01
Closing force 250 gr
EM-07-995-02
Closing force 350 gr
Straight



EM-07-996-01
Closing force 250 gr
EM-07-996-02
Closing force 350 gr
Curved



MÜLLER
EM-07-997-01
Closing force 250 gr
EM-07-997-02
Closing force 350 gr
Curved



MÜLLER
EM-07-998-01
Closing force 250 gr
EM-07-998-02
Closing Force 350 gr
Knee-bent



Total length Length of jaws

DIEFFENBACH
EM-07-999-01 38 mm 12 mm
EM-07-999-02 48 mm 16 mm

Total length Length of jaws

DIEFFENBACH
EM-07-1001-01 38 mm 12 mm
EM-07-1001-02 48 mm 16 mm

Total length Length of jaws

DIEFFENBACH
EM-07-1002-01 58 mm 16 mm

Total length Length of jaws

DIEFFENBACH
EM-07-1003 58 mm 16 mm



Total length Length of jaws

DE BAKEY-HESS
EM-07-1004-01 34 mm 20mm
EM-07-1004-02 43 mm 30mm



Total length Length of jaws

JOHNS-HOPKINS
EM-07-1005-01 38 mm 12 mm
EM-07-1005-02 48 mm 17 mm
EM-07-1005-03 56 mm 25 mm
EM-07-1005-04 63 mm 30 mm
EM-07-1005-05 70 mm 33 mm
EM-07-1005-06 80 mm 42 mm
EM-07-1005-07 91 mm 52 mm



JOHNS-HOPKINS
EM-07-1006
Forceps for applying and
removing bulldog clamps
G 020.00-G 030.01 and H 120.00-H 121.03
24 cm



EM-07-1007 - 1008
Length of jaws 14 mm
35 m



EM-07-1009
Length of jaws 19 mm
45 mm



EM-07-1010
Length of jaws 19 mm
45 mm



DIETRICH
EM-07-1011-01
Length of jaws 13 mm
55 mm



DIETRICH
EM-07-1011-02
Length of jaws 10 mm
48 mm



DIETRICH
EM-07-1011-03
Length of jaws 13 mm
48 mm



Toothing De Bakey

Closing force 180 gr.



Vi

EM-07-1012-01
Length of jaws 10 mm
Straight
5 cm



Vi

EM-07-1012-02
Length of jaws 14 mm
Straight
5.5 cm



Vi

EM-07-1012-03
Length of jaws 20 mm
Straight
6 cm



Vi

EM-07-1013
Length of jaws 20 mm
Curved
5.5 cm



Vi

EM-07-1014-01
Length of jaws 10 mm
Angled
5 cm



Vi

EM-07-1014-02
Length of jaws 14 mm
Angled
5 cm



Vi

EM-07-1014-03
Length of jaws 20 mm
Angled
5.5 cm



Toothing De BAkey



DE BAKEY
EM-07-1015
Length of jaws 27 mm
4.8 cm



DE BAKEY
EM-07-1016
Length of jaws 38 mm
7.3 cm



DE BAKEY
EM-07-1017
Length of jaws 63 mm
9.9 cm



DE BAKEY
EM-07-1018
Length of jaws 54 mm
9.5 cm



DE BAKEY
EM-07-1019
Length of jaws 27 mm
5 cm



GLOVER
EM-07-1020
Length of jaws 35 mm
5.2 cm



	Total length	Length of jaws
GLOVER EM-07-1019-01	6.8 cm	33 mm
EM-07-1019-02	9.6 cm	50 mm
EM-07-1019-03	11.7 cm	69 mm



	Total length	Length of jaws
GLOVER EM-07-1021-01	6.5 cm	33 mm
EM-07-1022-02	9.1 cm	50 mm
EM-07-1023-03	11 cm	69 mm



	Toplam boy Total length	Ağız uzunluğu Length of jaws
DE BAKEY EM-07-1022-01	8.0 cm	25 mm
EM-07-1022-02	9.0 cm	35 mm
EM-07-1022-03	10.5 cm	50 mm
EM-07-1022-04	12.4 cm	68 mm



	Toplam boy Total length	Ağız uzunluğu Length of jaws
DE BAKEY EM-07-1023-01	7.8 cm	23 mm
EM-07-1023-02	8.6 cm	31 mm
EM-07-1023-03	9.7 cm	42 mm
EM-07-1023-04	11.4 cm	58 mm

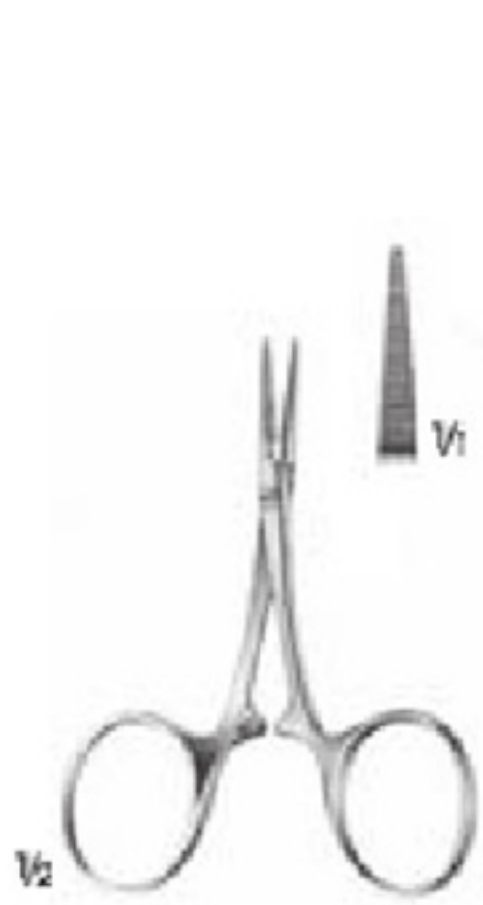

CARREL
EM-07-1024
8.5 cm

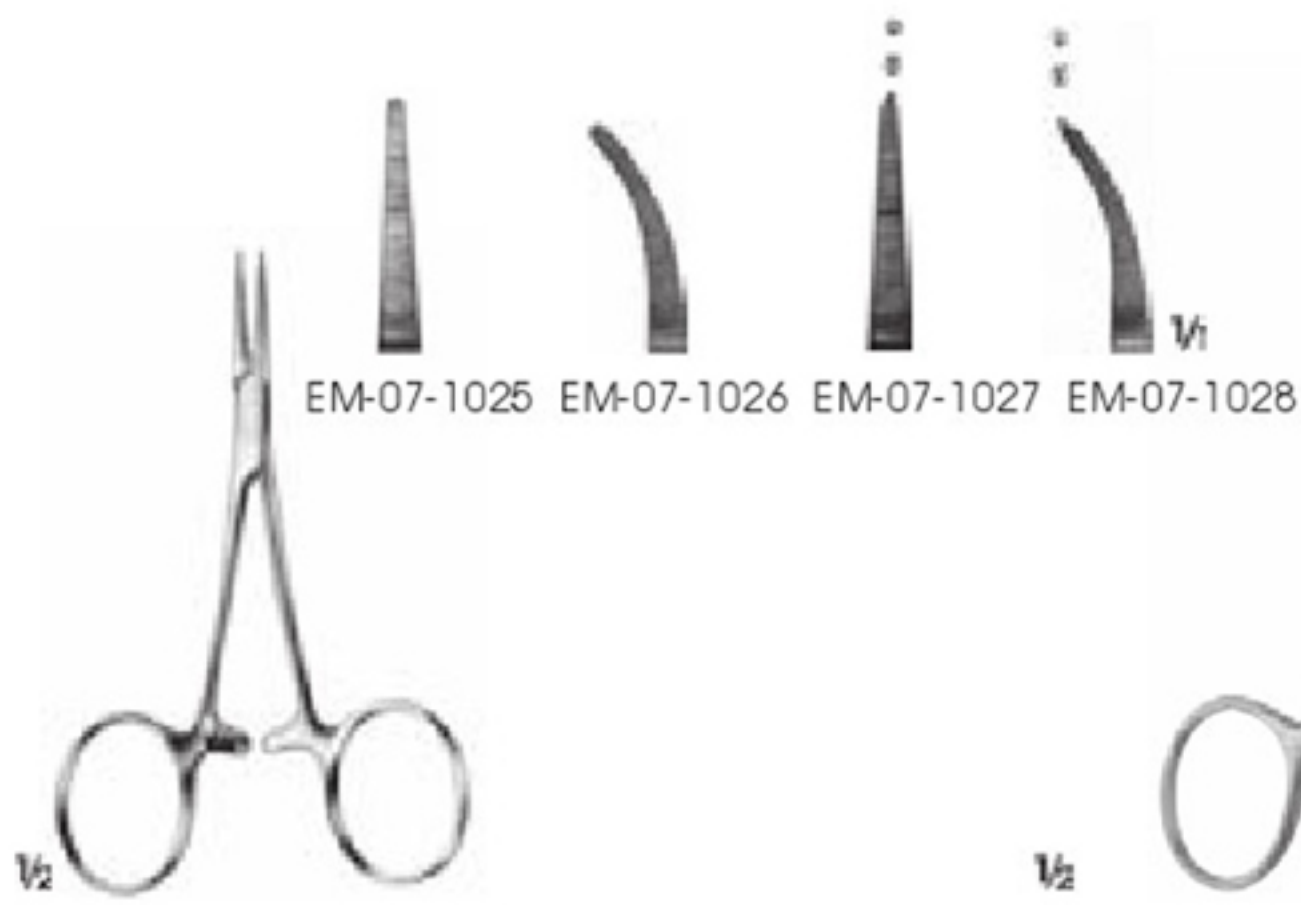

BABY-MOSQUITO
(HARTMANN)
EM-07-1025 - 1028
10 cm



DUNHILL
EM-07-1029
12.5 cm

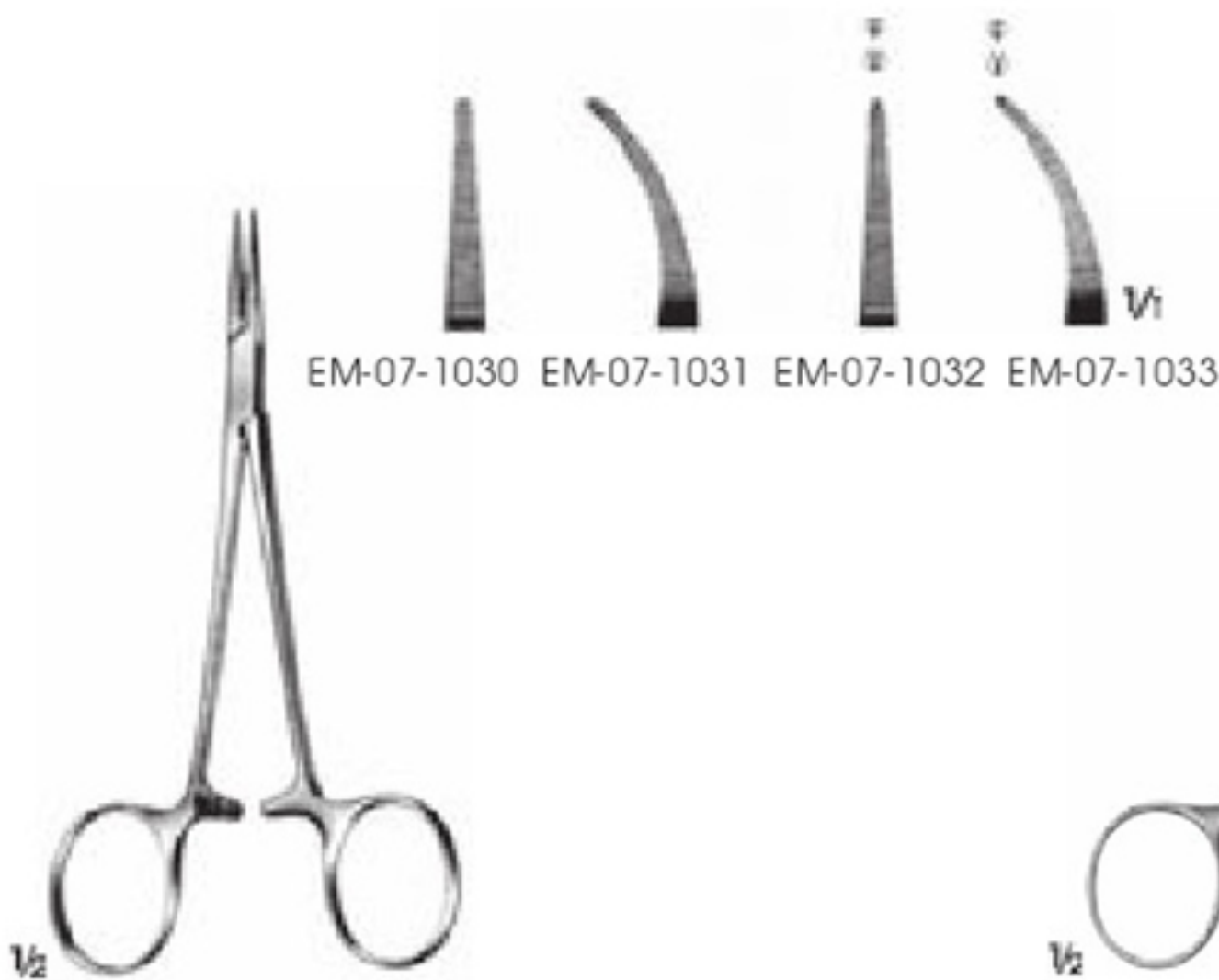

MICRO-HALSTED
EM-07-1030 - 1033
12.5 cm

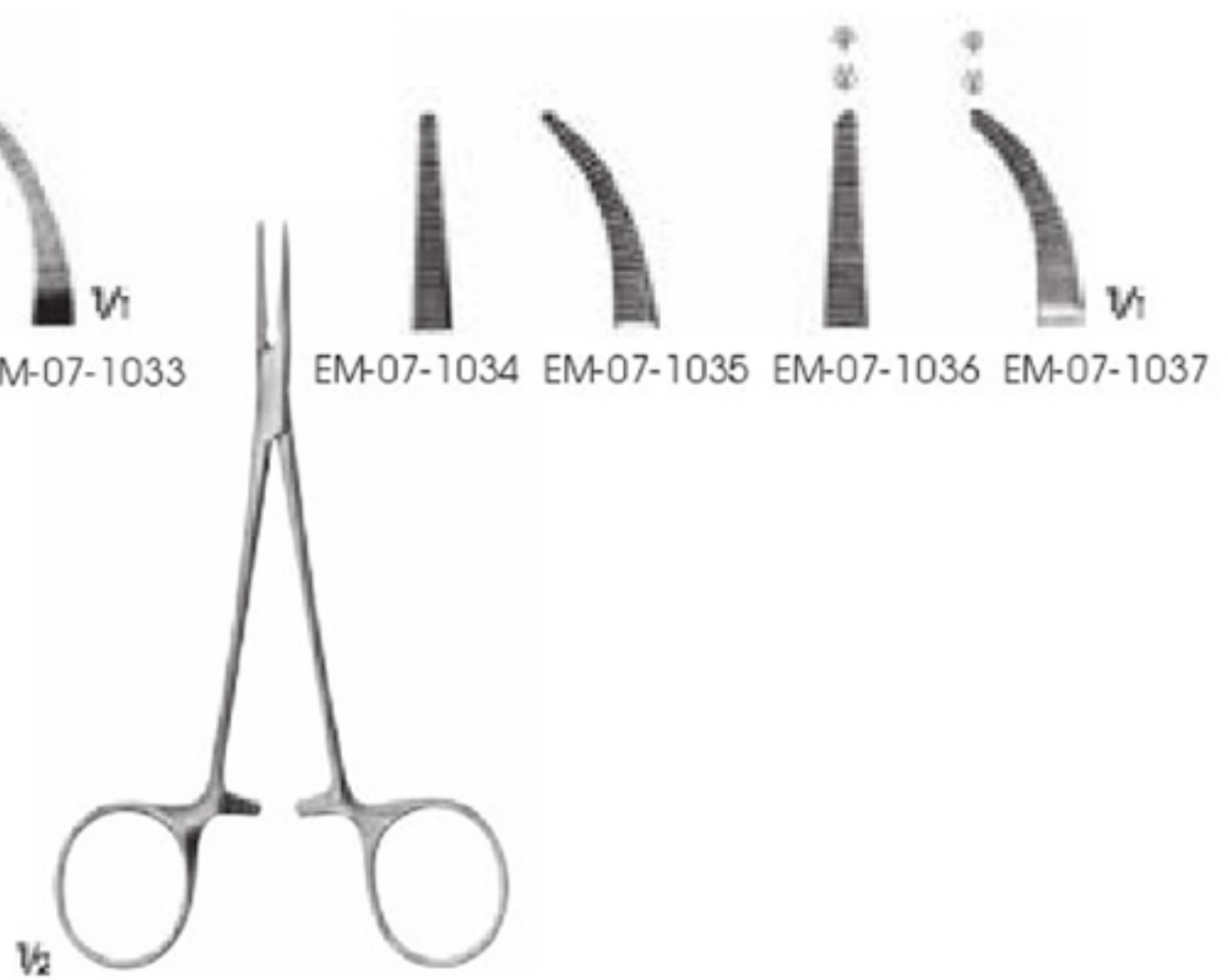

HALSTED-MOSQUITO
EM-07-1034 - 1037
12.5 cm

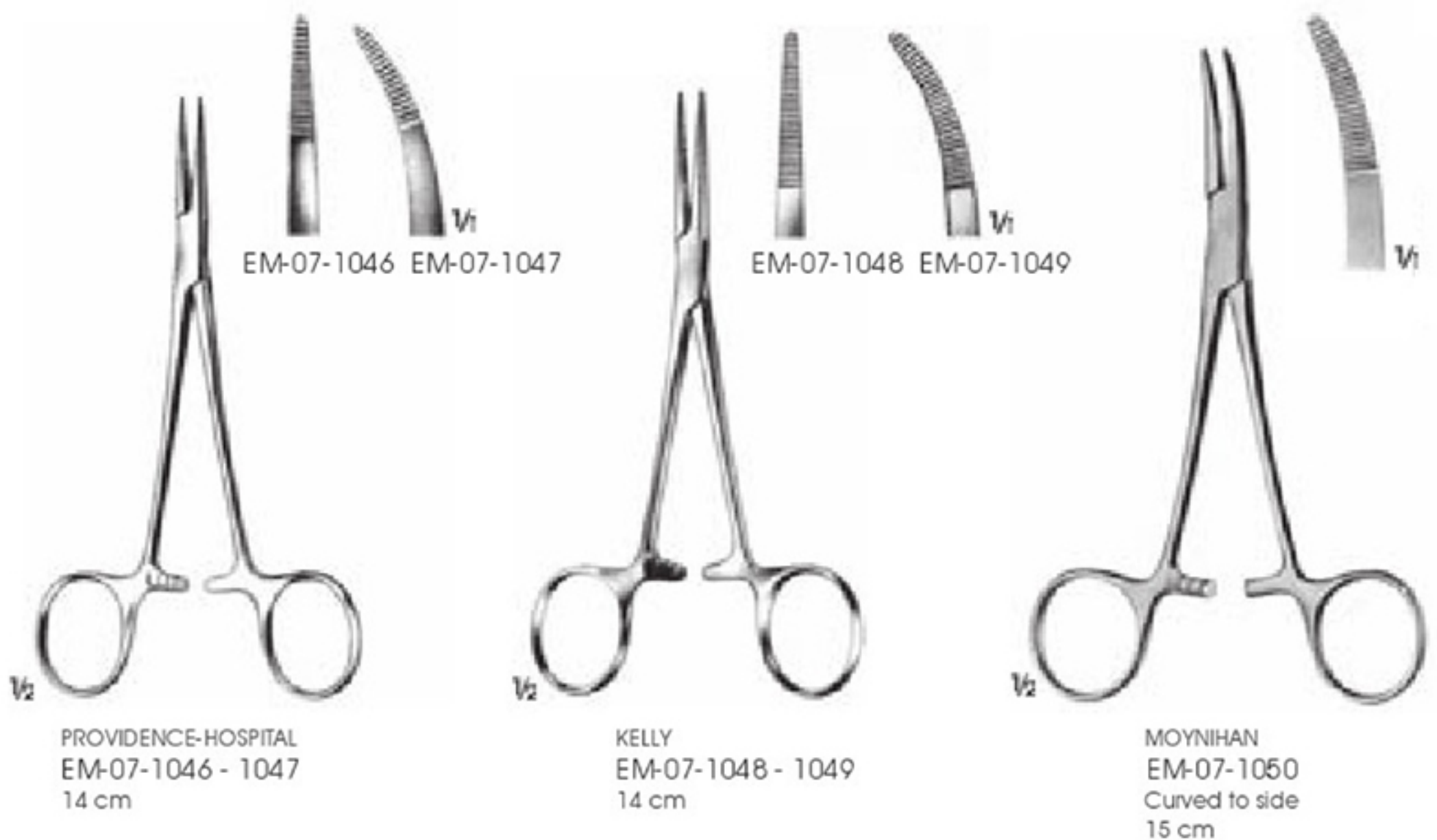
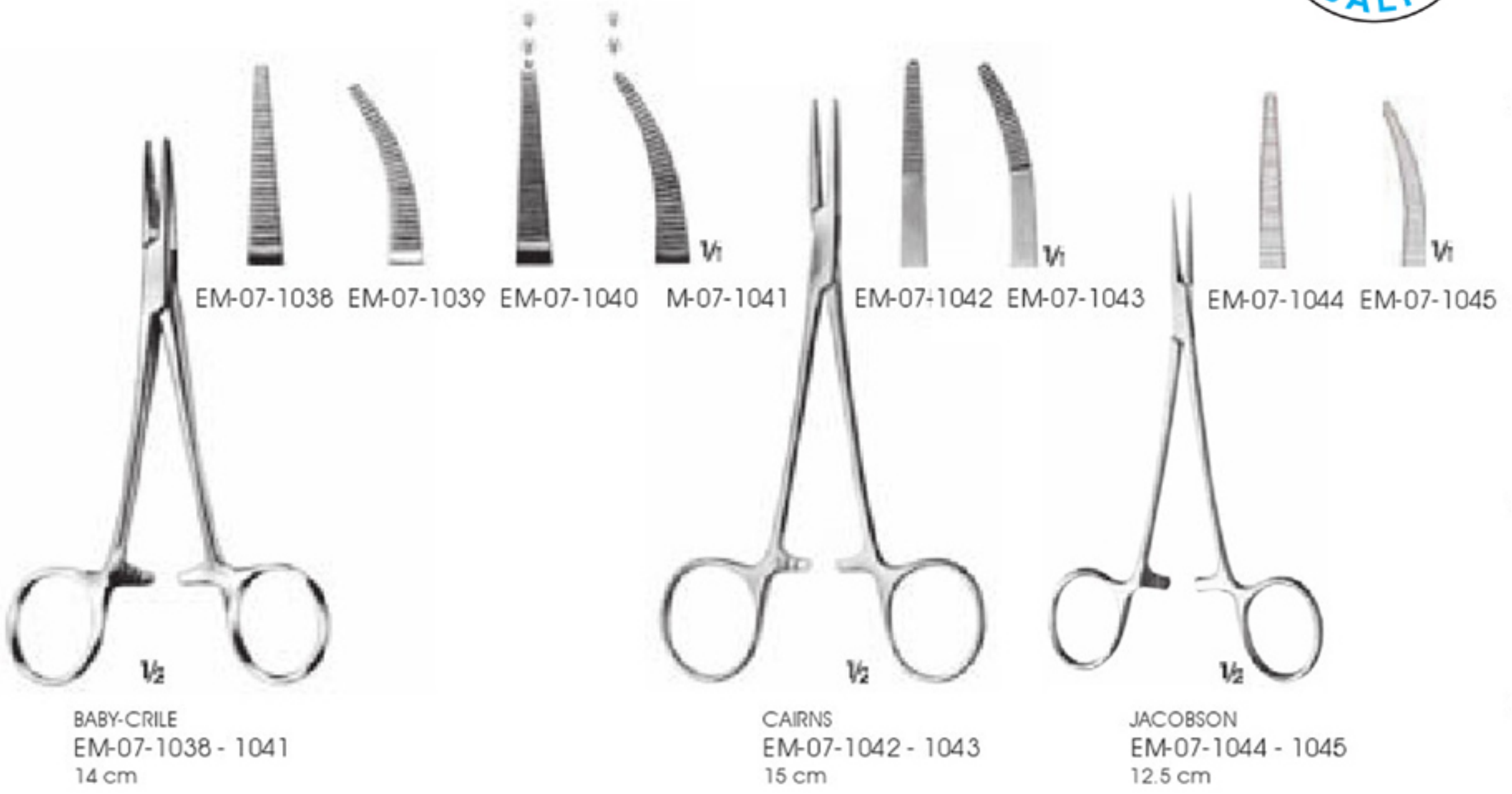



CAIRNS
EM-07-1051
Curved to side
14.5 cm



DANDY
EM-07-1052 - 1053
Curved to side
14 cm



CRILE
EM-07-1054 - 1057
14 cm

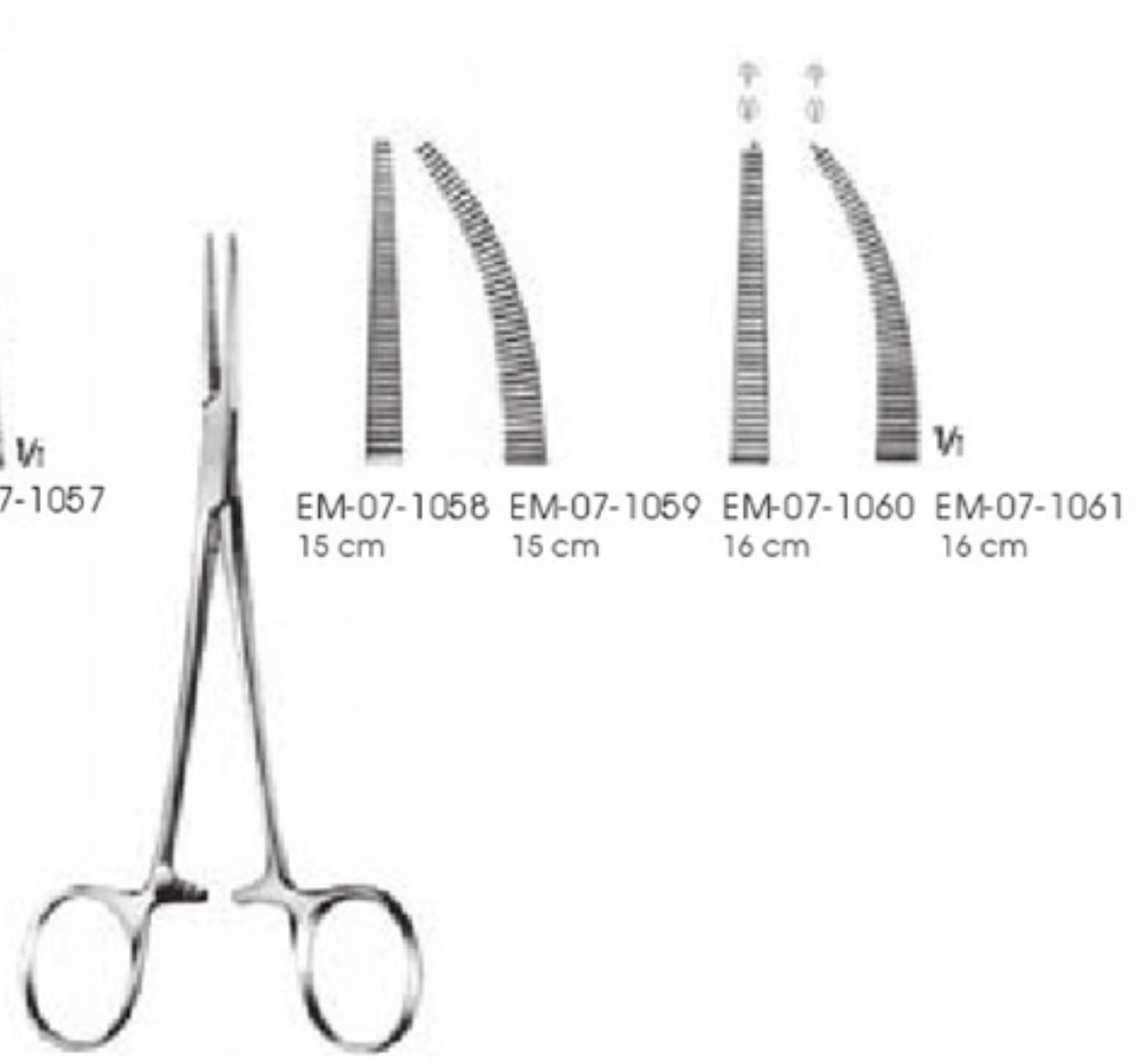

LERICHE
EM-07-1058 - 1061



RANKIN
EM-07-1062 - 1063
16 cm

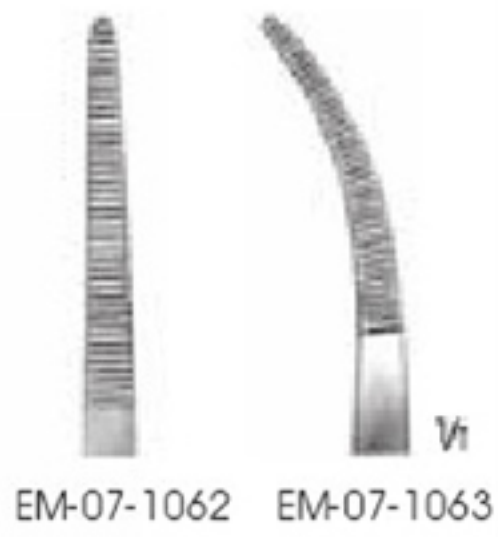

CRILE
EM-07-1064 - 1067
16 cm

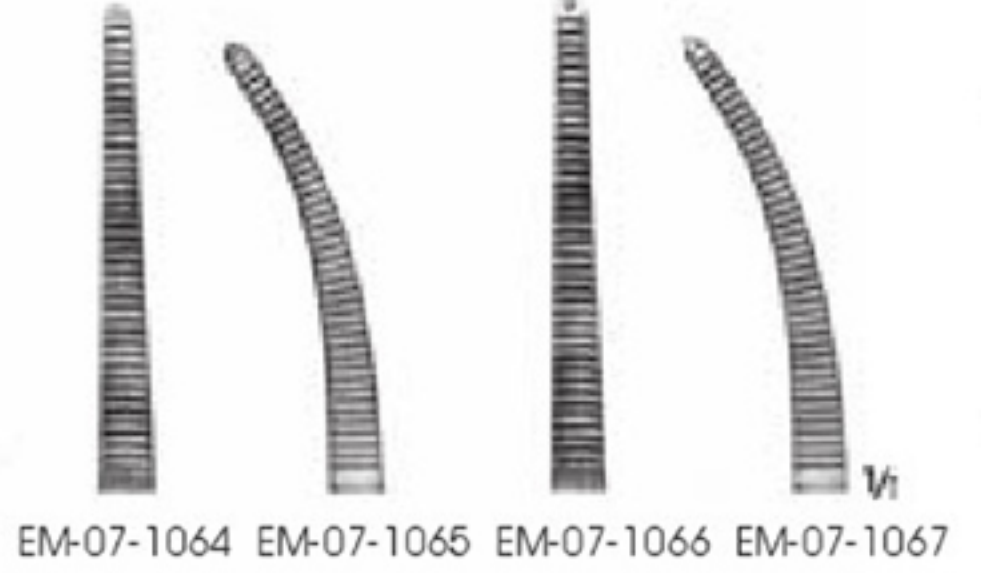

COLLER
EM-07-1068-01 - 1068-06

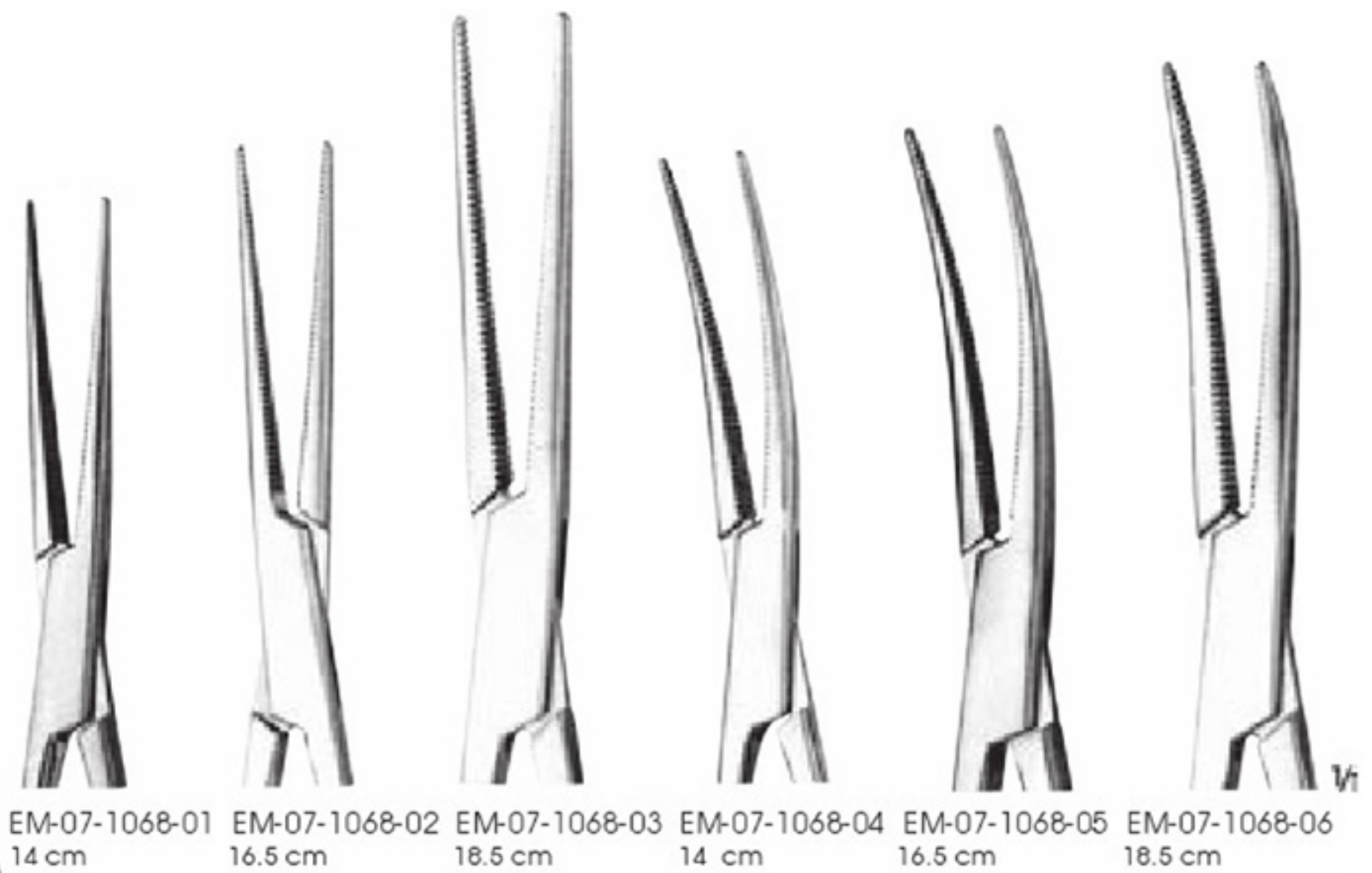

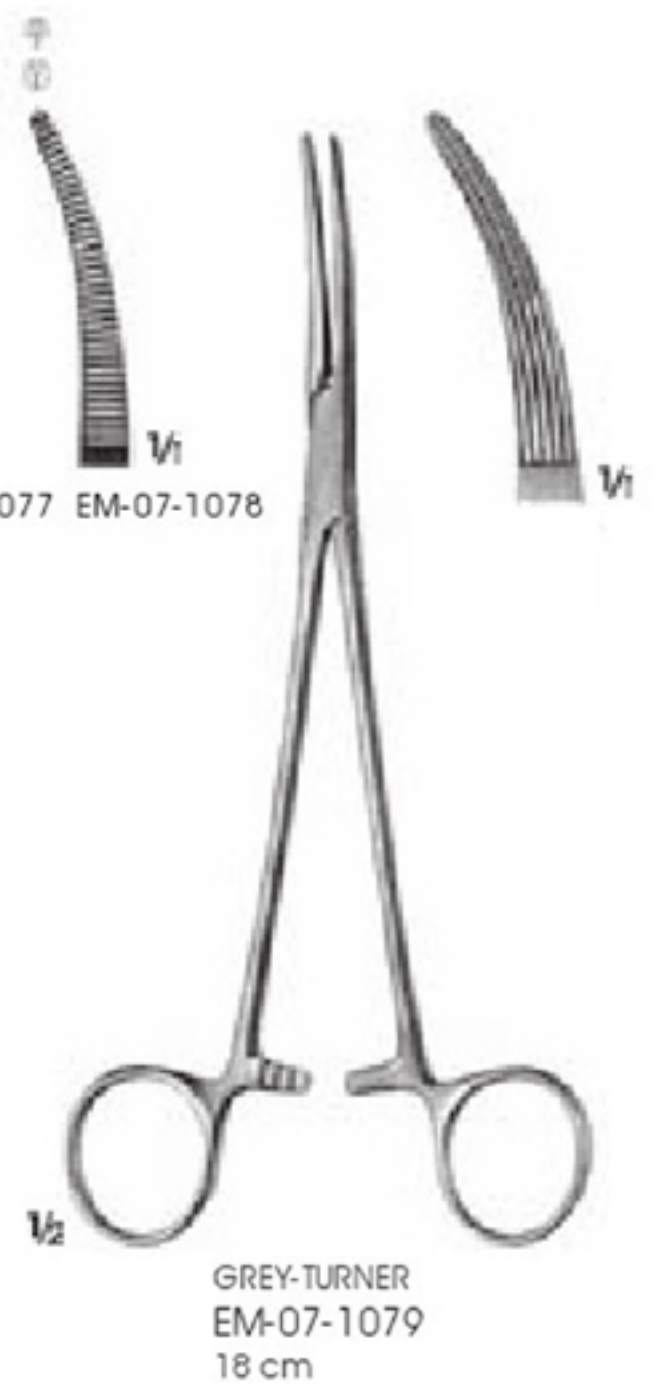
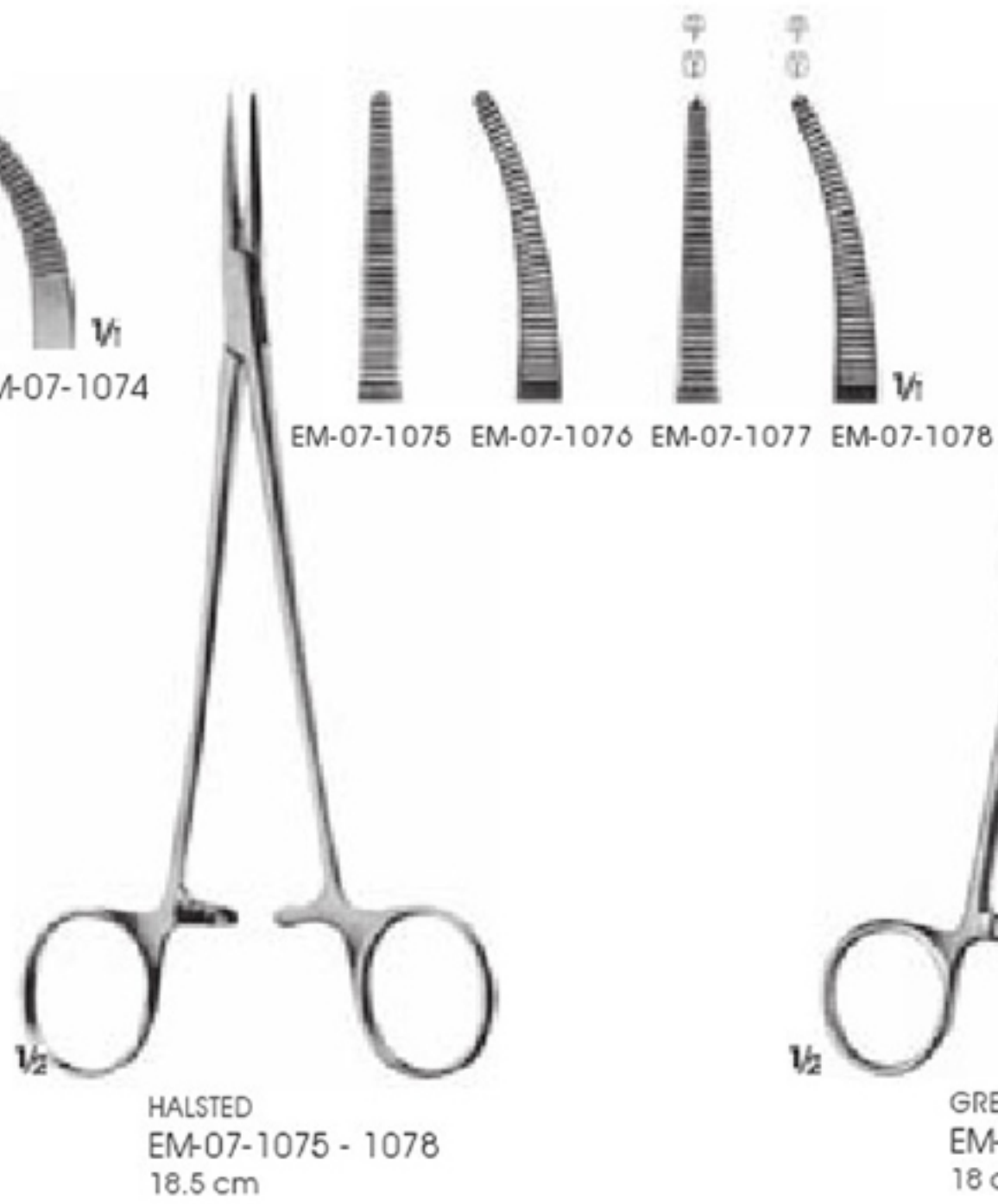
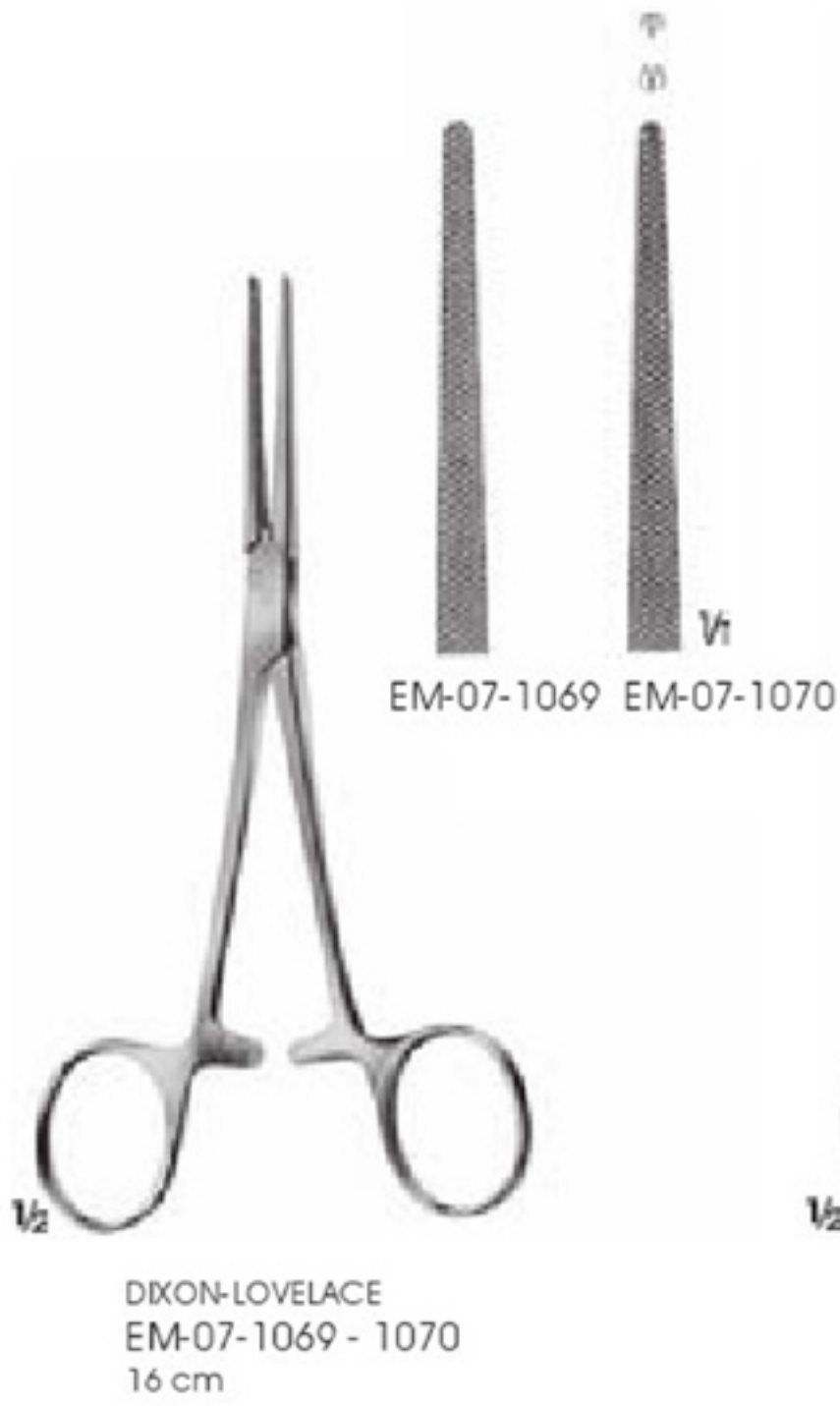



EM-07-1080 EM-07-1081

$\frac{1}{2}$
BIRKETT
EM-07-1080 - 1081
18.5 cm



EM-07-1082 EM-07-1083 EM-07-1084 EM-07-1085

$\frac{1}{2}$
HALSTED-MOSQUITO
EM-07-1082 - 1085
20 cm



$\frac{1}{2}$
FRASER-KELLY(CRILE)
EM-07-1086
18 cm



$\frac{1}{2}$
DUNHILL
EM-07-1087
19 cm



$\frac{1}{2}$
JACOBSON
EM-07-1088
19 cm

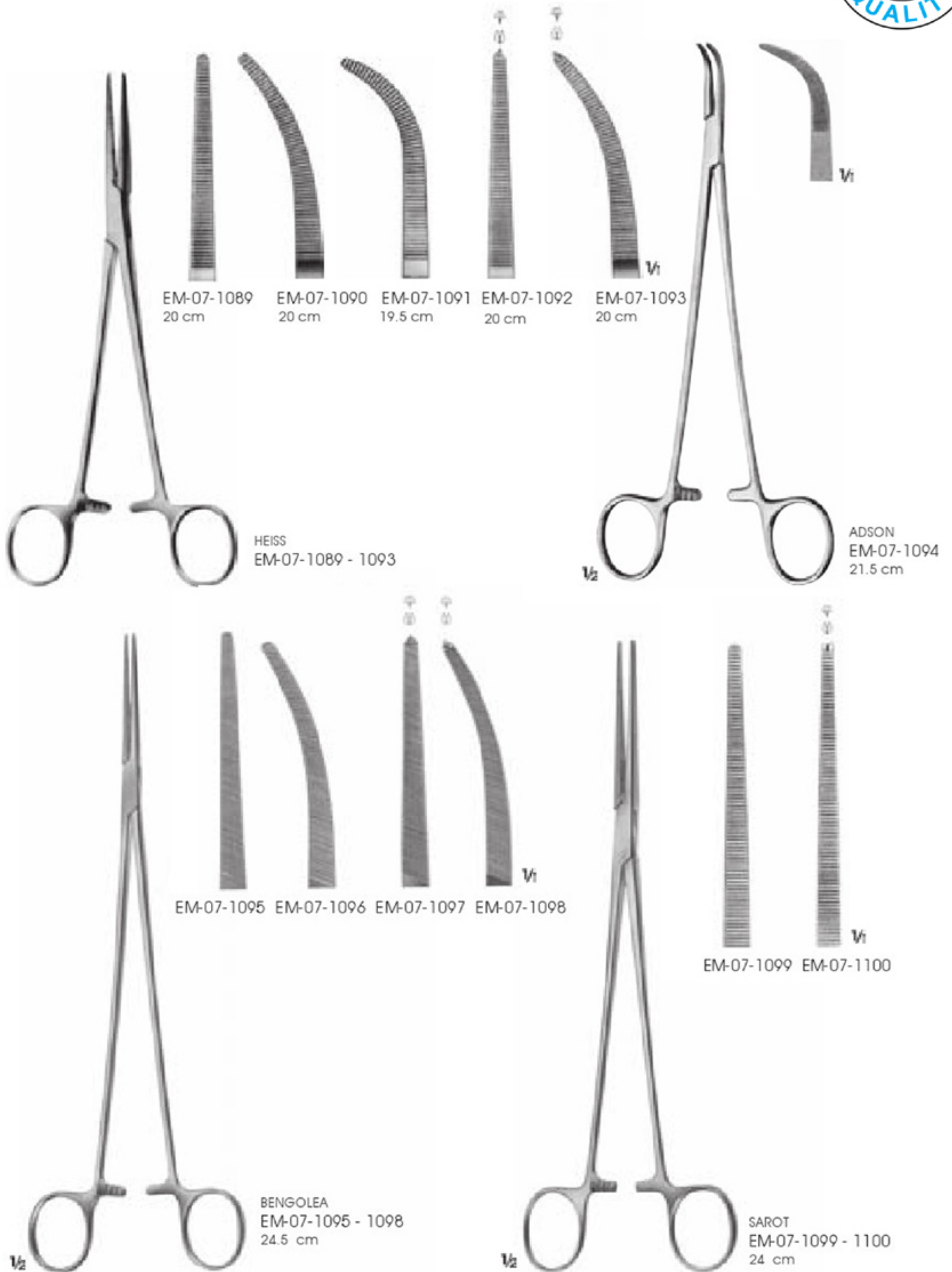



CRAFOORD
EM-07-1101
24.5 cm



CRAFOORD, MOD.
EM-07-1102
24 cm

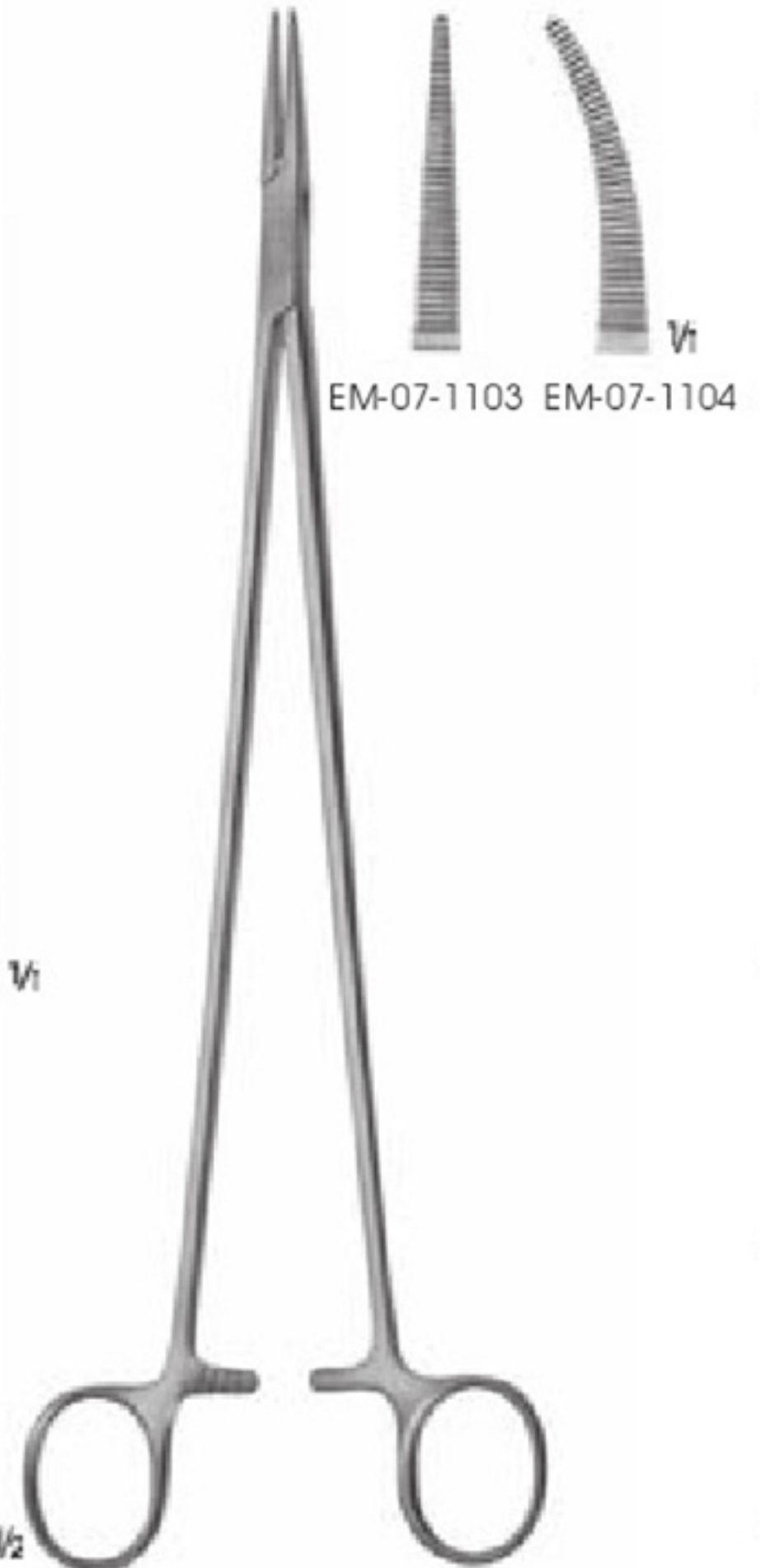

BRIDGE
EM-07-1103 - 1104
27.5 cm

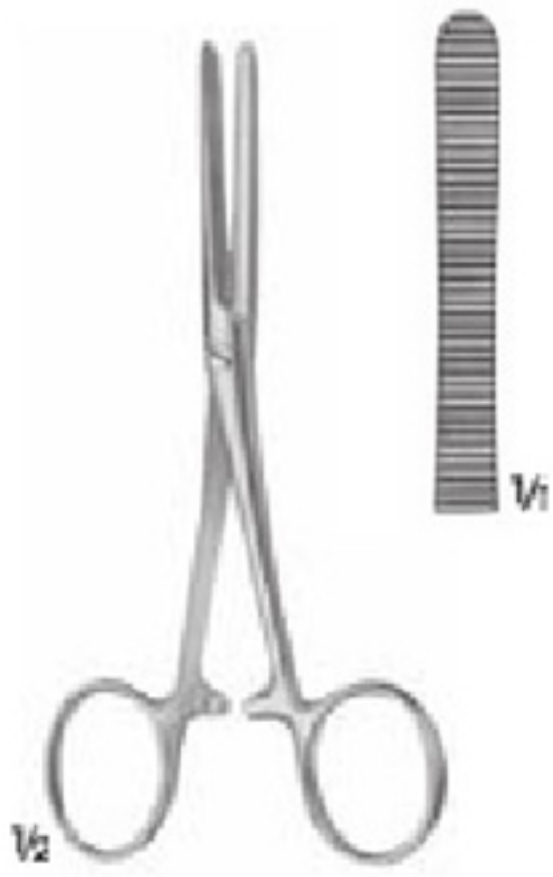

PEAN
EM-07-1105
12.5 cm

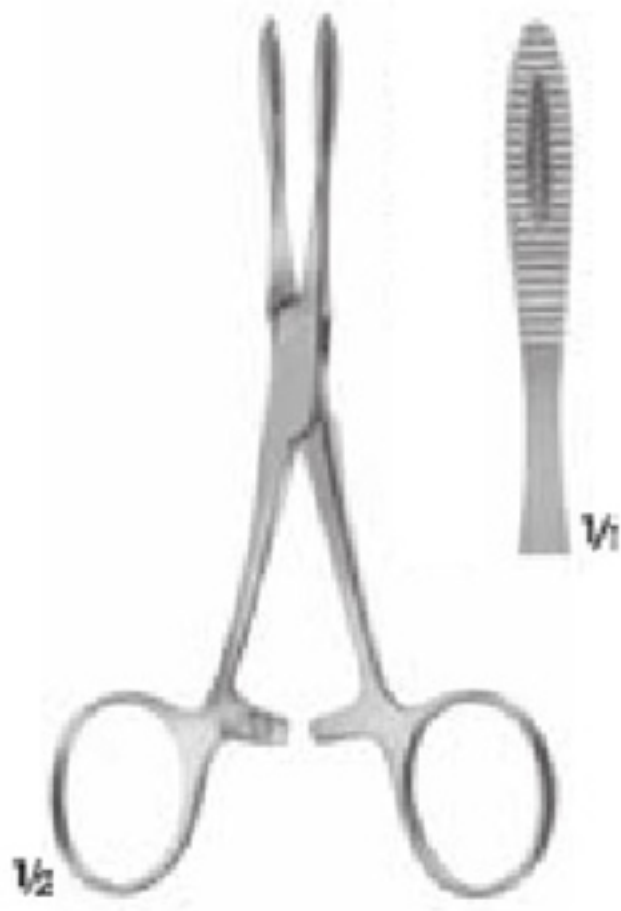

KRÖNLEIN
EM-07-1106
13 cm



PEAN
EM-07-1107
12.5 cm



PEAN
EM-07-1108-01 - 1108-02



PEAN
EM-07-1109-01 - 1109-02

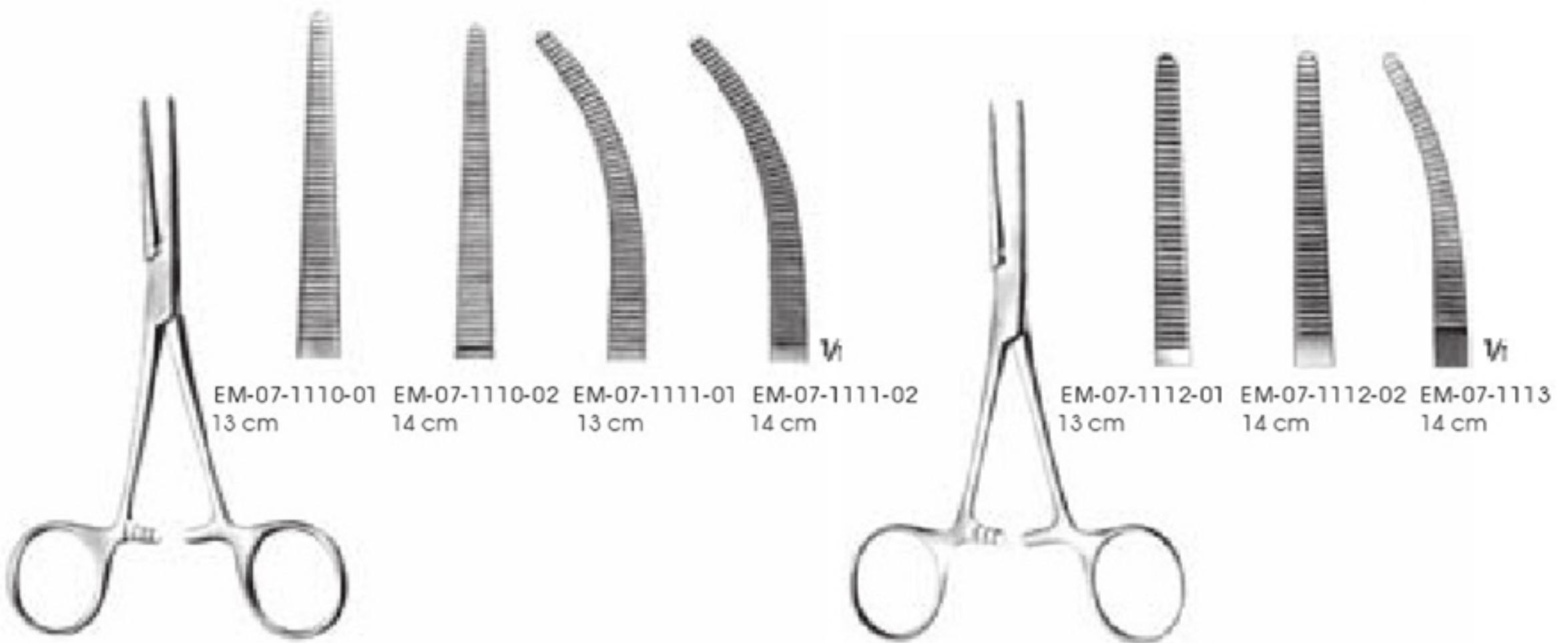

PEAN
EM-07-1110-01 - 1111-02
Slender type

PEAN
EM-07-1112-01 - 1113

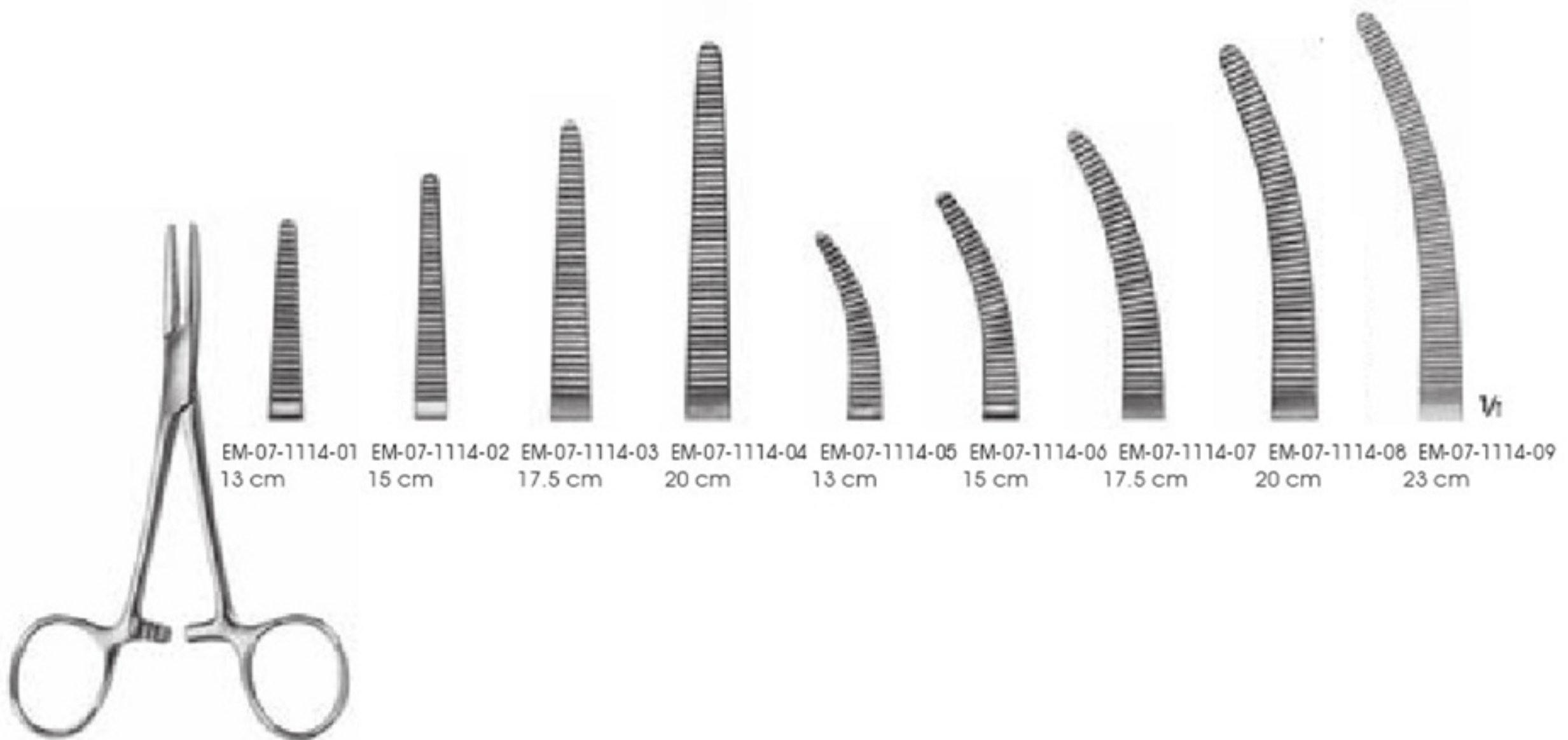

SPENCER - WELLS
EM-07-1114-01 - 1114-09

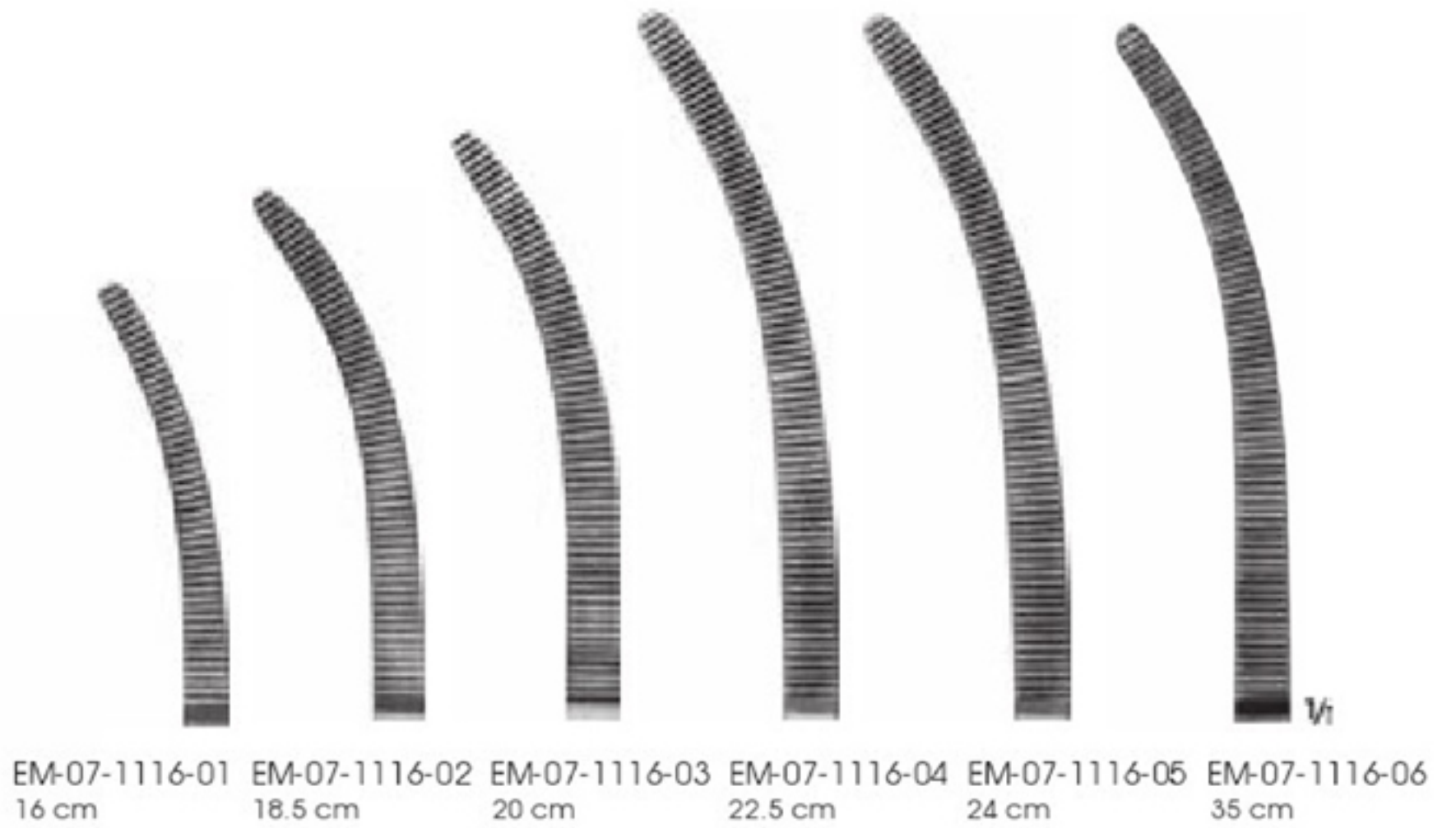

ROCHESTER - PEAN
EM-07-1115-01 - 1116-01

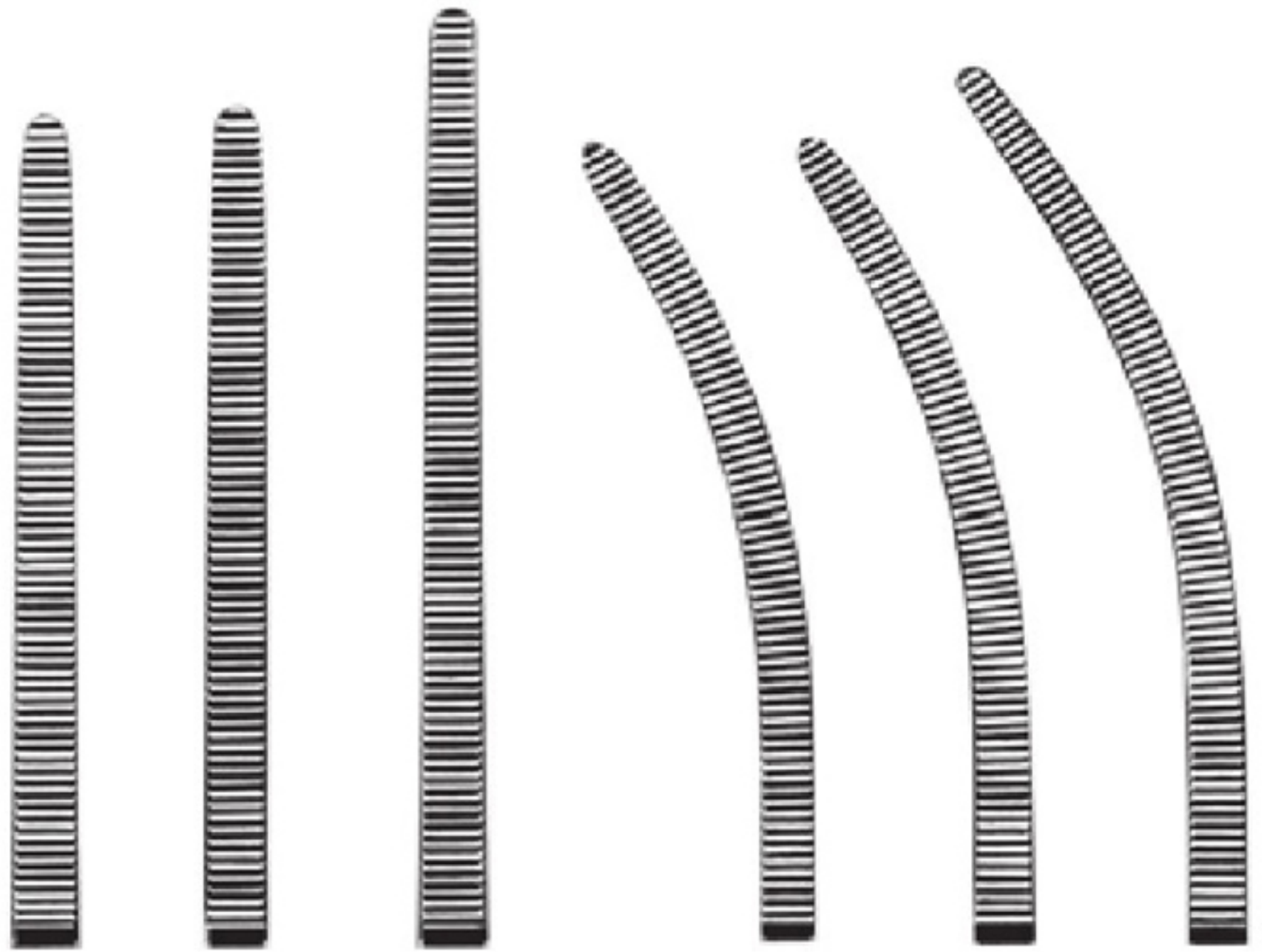

EM-07-1117-01
24 cm

EM-07-1117-02
26 cm

EM-07-1117-03
28 cm

EM-07-1118-01
24 cm

EM-07-1118-02
26 cm

EM-07-1118-03
28 cm

Vi



PEAN
EM-07-1117-01 - 1118-03



KOCHER
EM-07-1119
Strong pattern
14.5 cm



ROCHESTER-OGHSNER
EM-07-1120 - 1121
14 cm

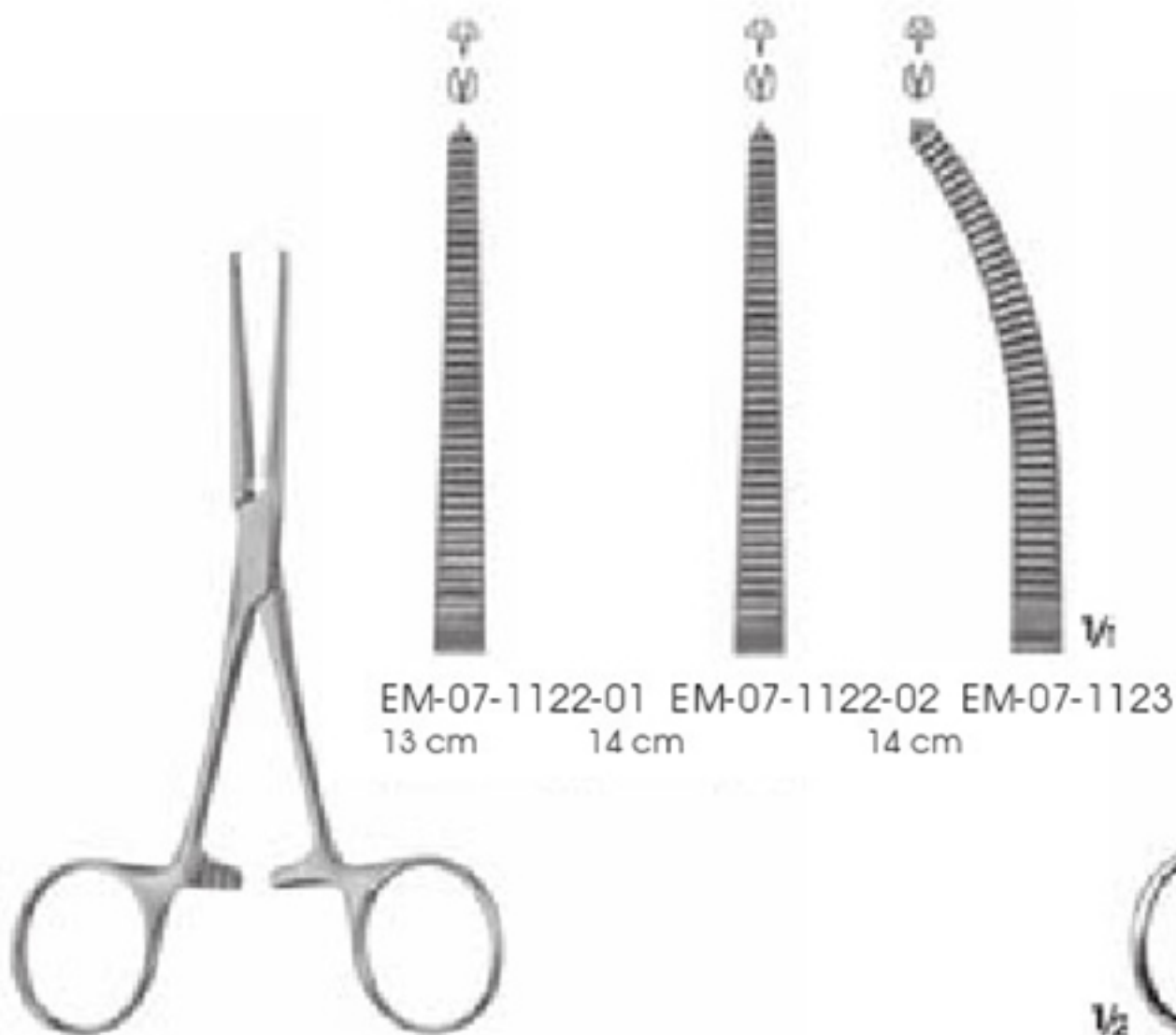

KOCHER
EM-07-1122-01 - 1123



KOCHER
EM-07-1124 - 1125
15 cm

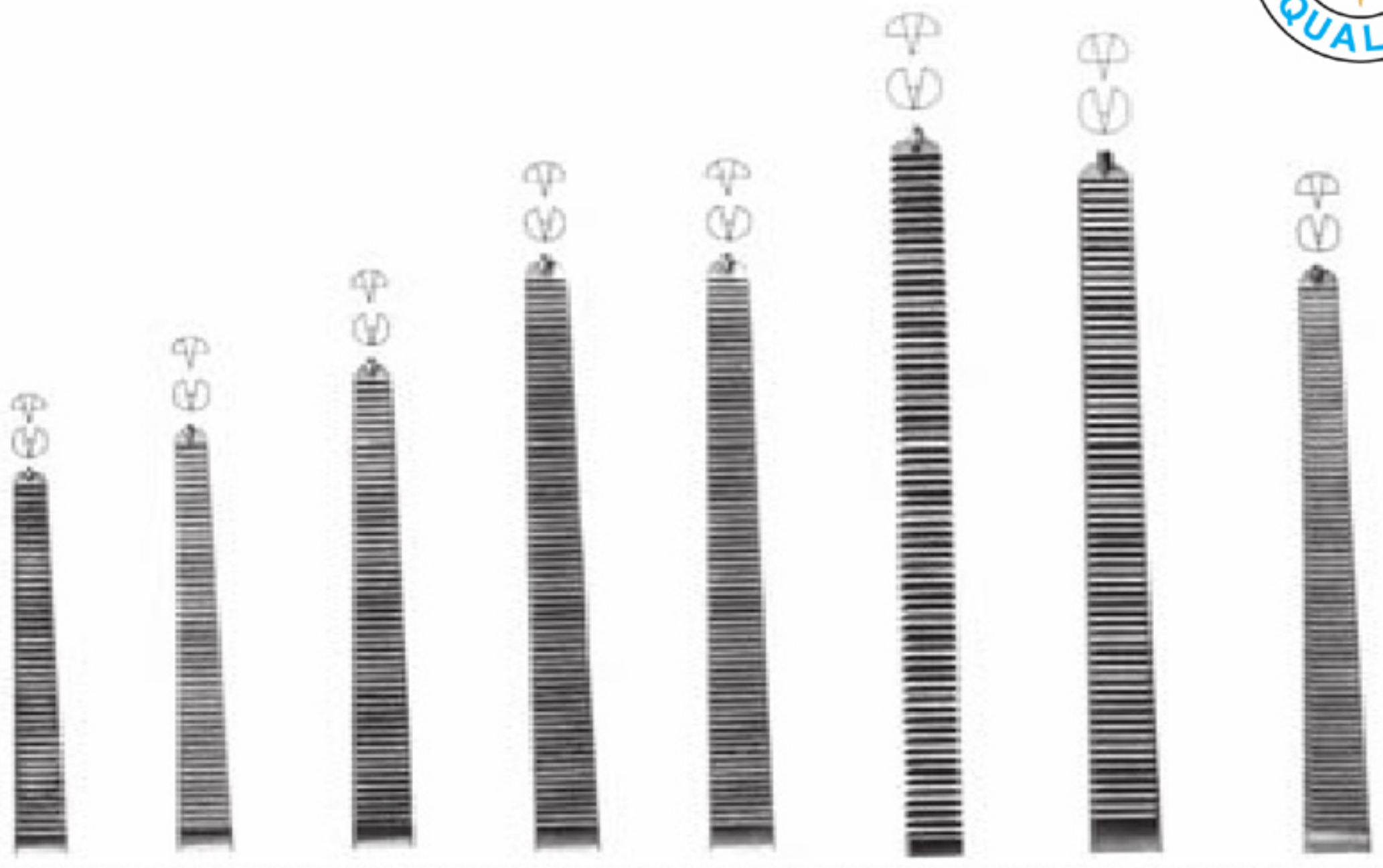

EM-07-1126-01 16 cm EM-07-1126-02 18.5 cm EM-07-1126-03 20 cm EM-07-1126-04 22.5 cm EM-07-1126-05 24 cm EM-07-1126-06 26 cm EM-07-1126-07 28 cm EM-07-1126-08 35 cm

Vi

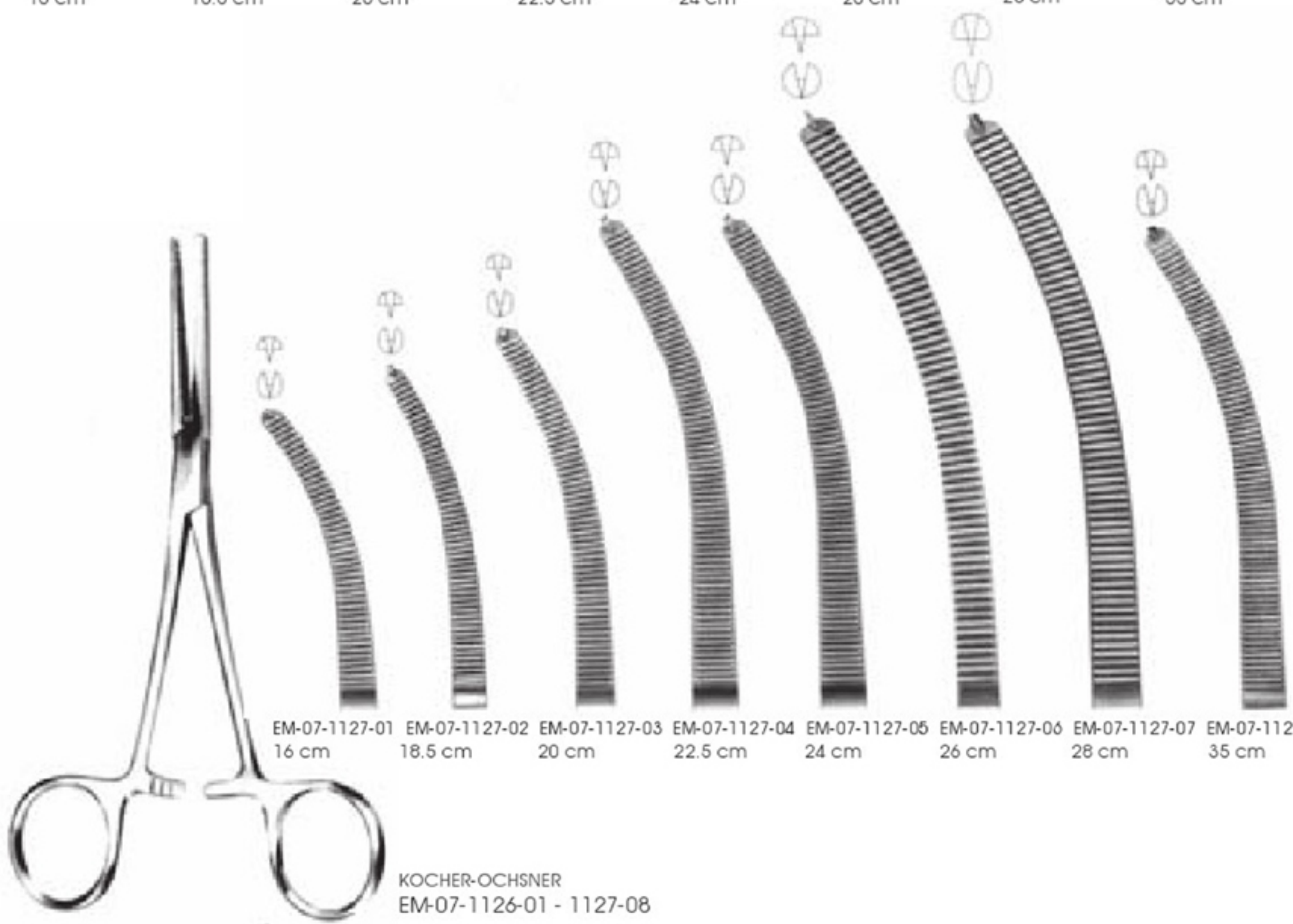

EM-07-1127-01 16 cm EM-07-1127-02 18.5 cm EM-07-1127-03 20 cm EM-07-1127-04 22.5 cm EM-07-1127-05 24 cm EM-07-1127-06 26 cm EM-07-1127-07 28 cm EM-07-1127-08 35 cm

Vi

KOCHER-OCHSNER
EM-07-1126-01 - 1127-08

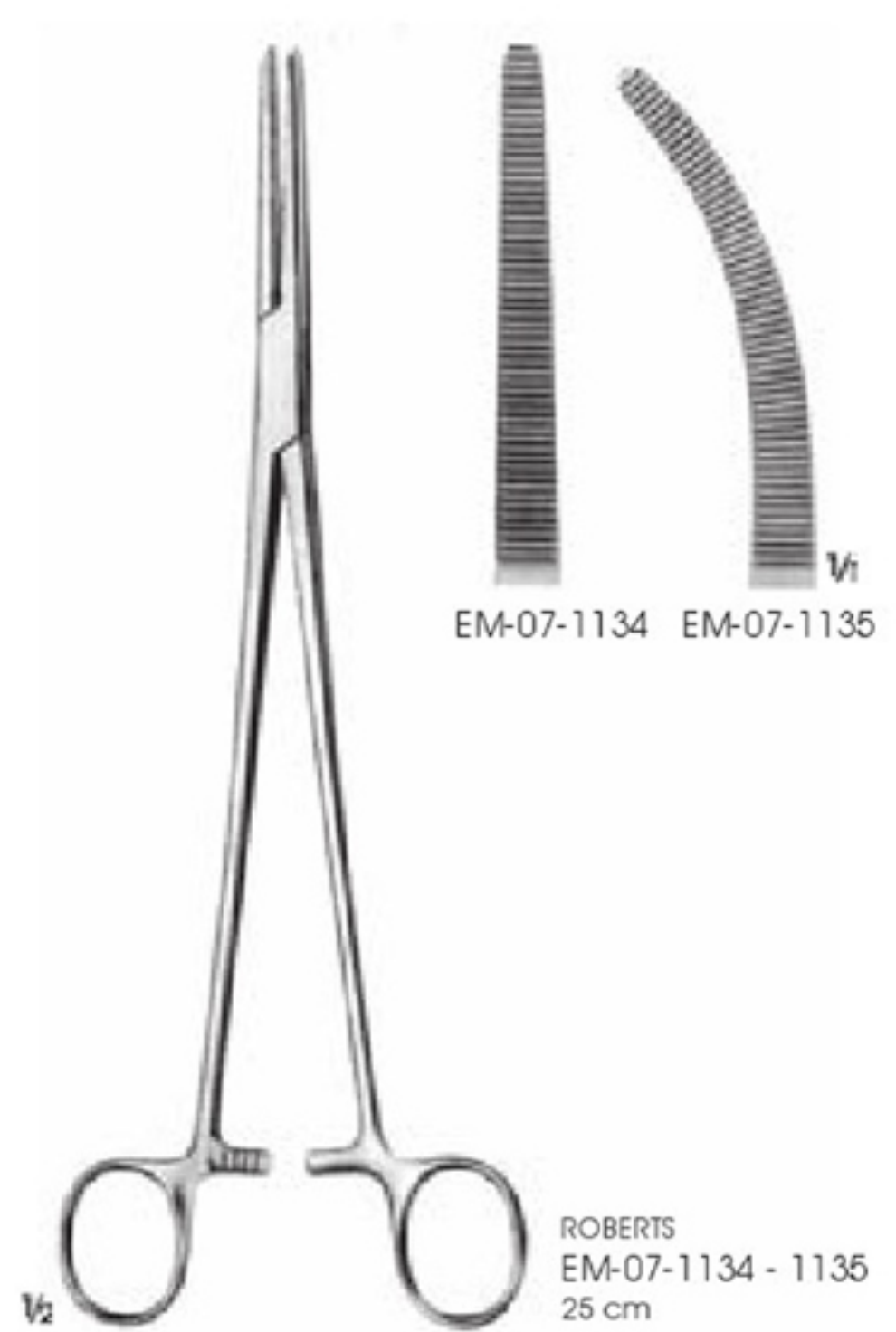
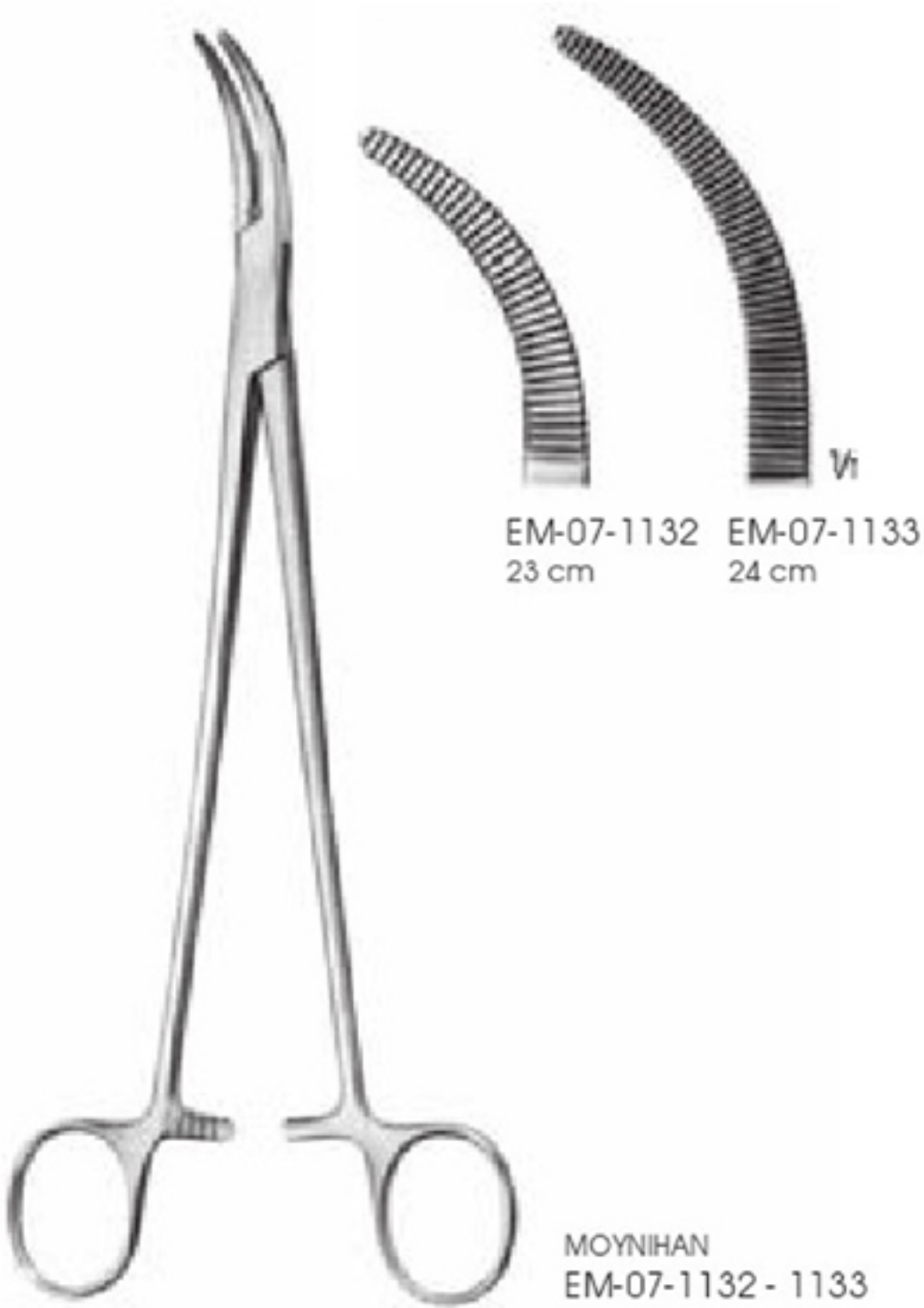
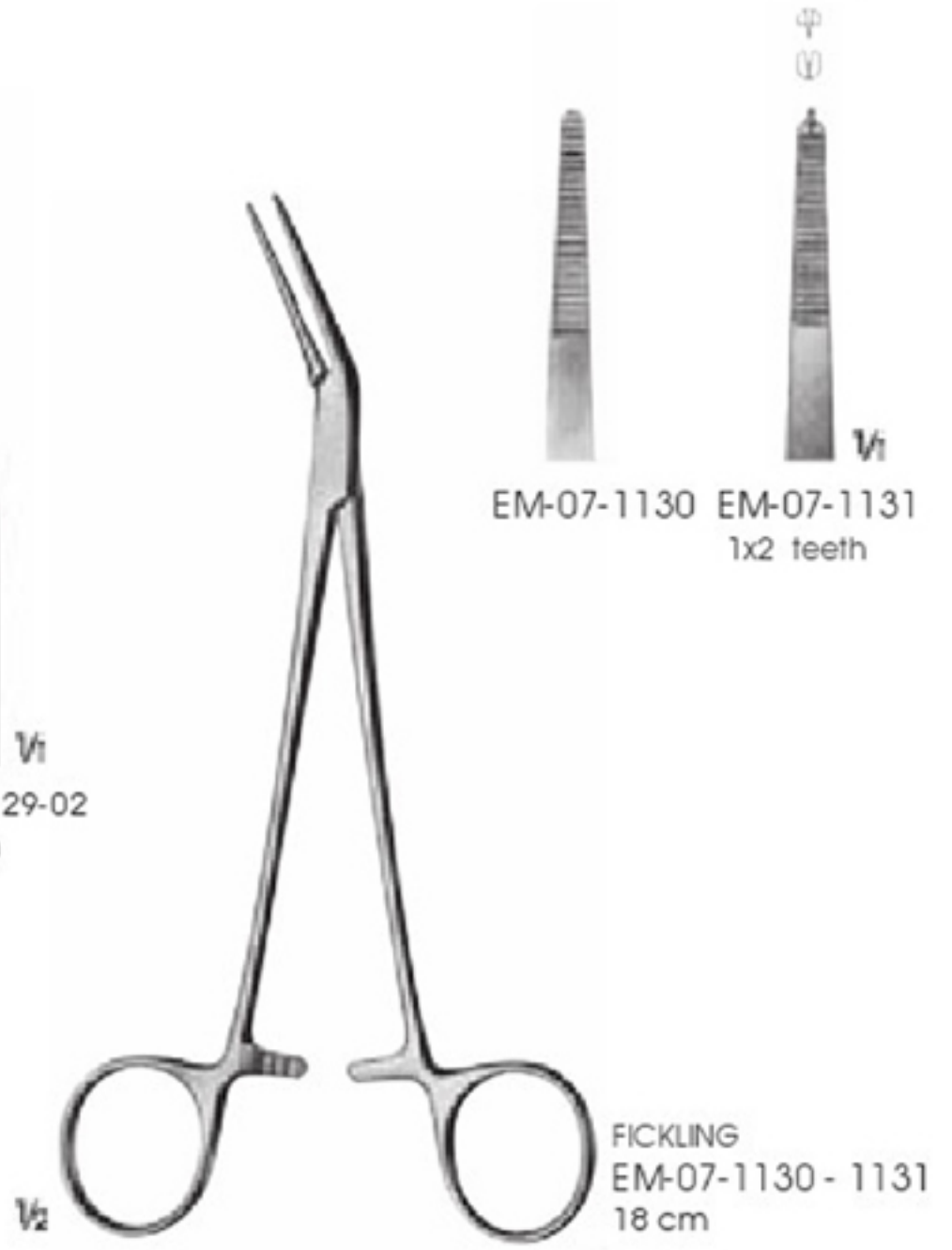



ROBERTS
 EM-07-1136
 22.5 cm



SAROT
 EM-07-1137
 25 cm



PEAN
 EM-07-1138-01 - 1138-03



EM-07-1138-01
 19.5 cm



EM-07-1138-02
 22 cm



EM-07-1138-03
 23 cm



SCHNIDT
 EM-07-1139-01 - 1139-02
 18.5 cm



SCHNIDT
 EM-07-1140-01 - 1140-02
 18.5 cm



NEGUS
 EM-07-1141-01 - 1141-02
 19 cm



MIKULICZ
 EM-07-1142
 18.5 cm

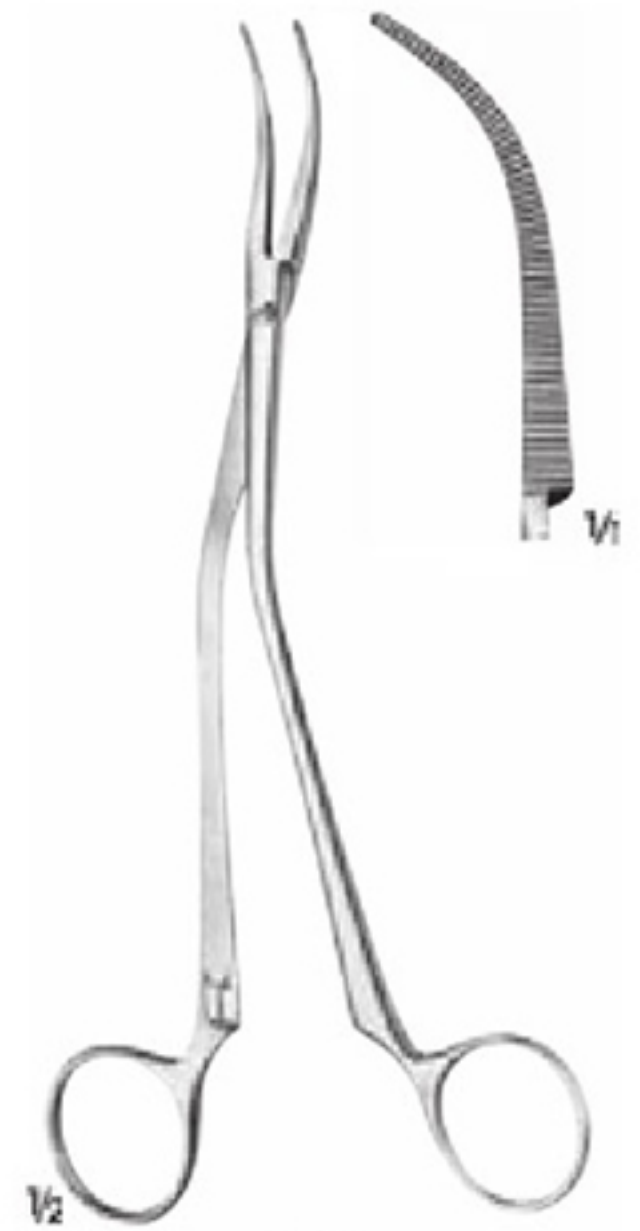

WILSON
 EM-07-1143
 19 cm

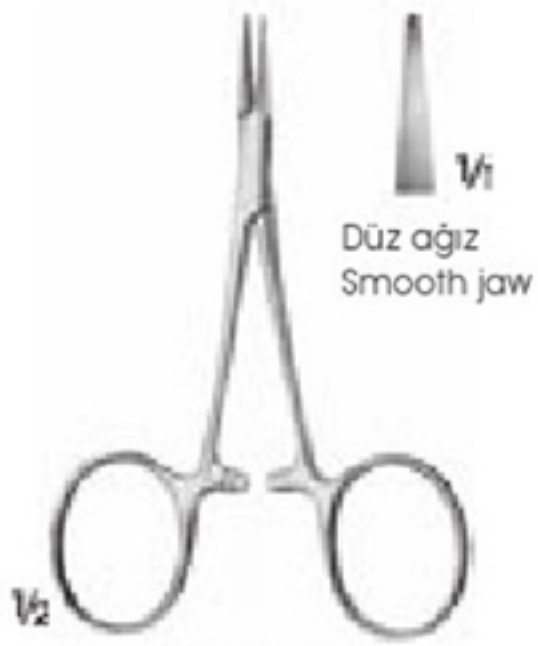

EM-07-1144
Ligature forcep, straight
9.5 cm



MICRO-ADSON
EM-07-1145
Dissecting forcep
14 cm

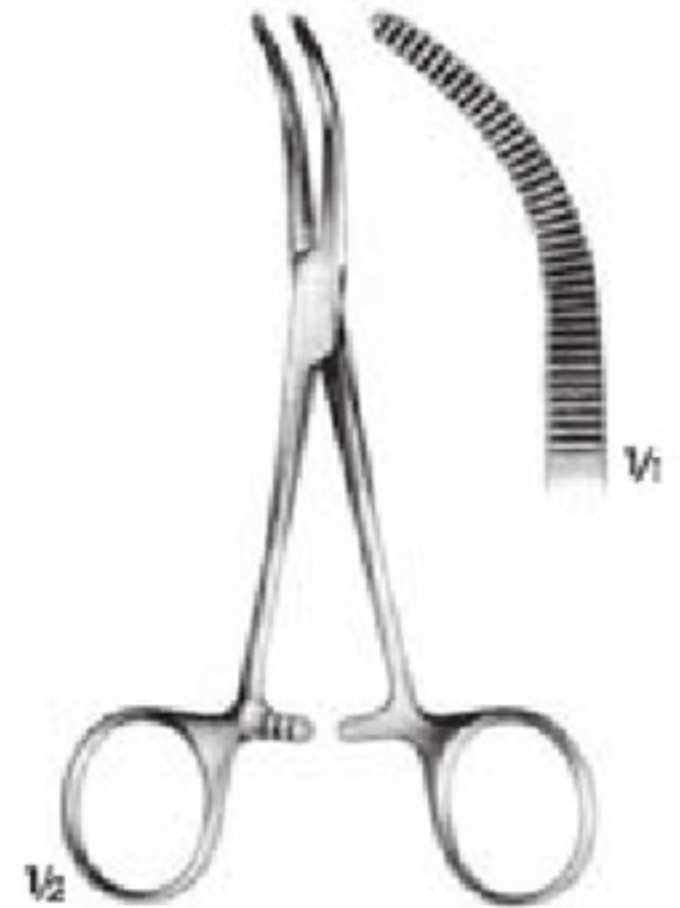

BABY-OVERHOLT
EM-07-1146
Dissecting forcep
13.5 cm



BABY-MIXTER
EM-07-1147-01 - 1147-02
Dissecting forceps



BABY-ADSON
EM-07-1148-01 - 1148-02
Dissecting forceps

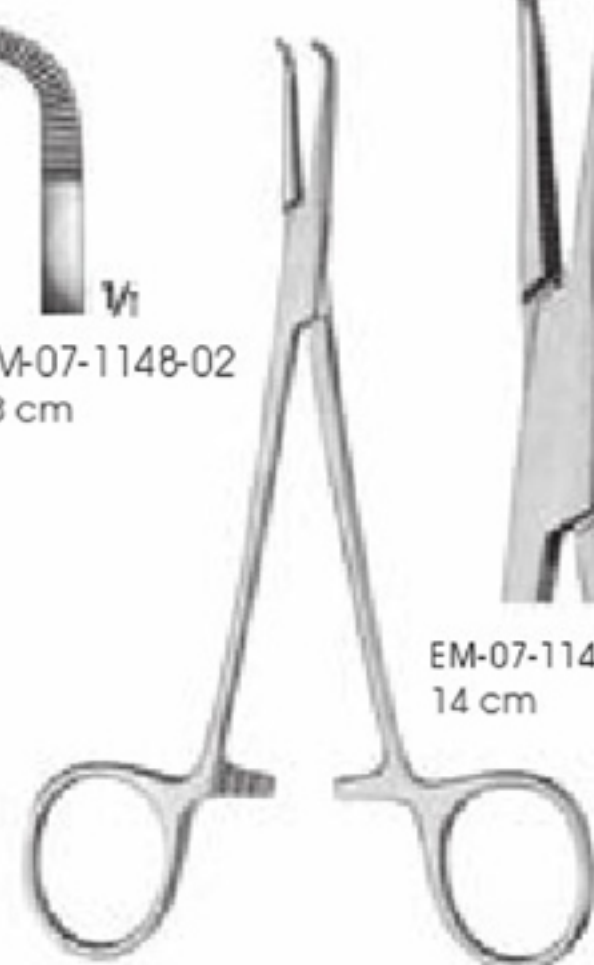

EM-07-1149-01 - 1149-02
Dissecting forceps



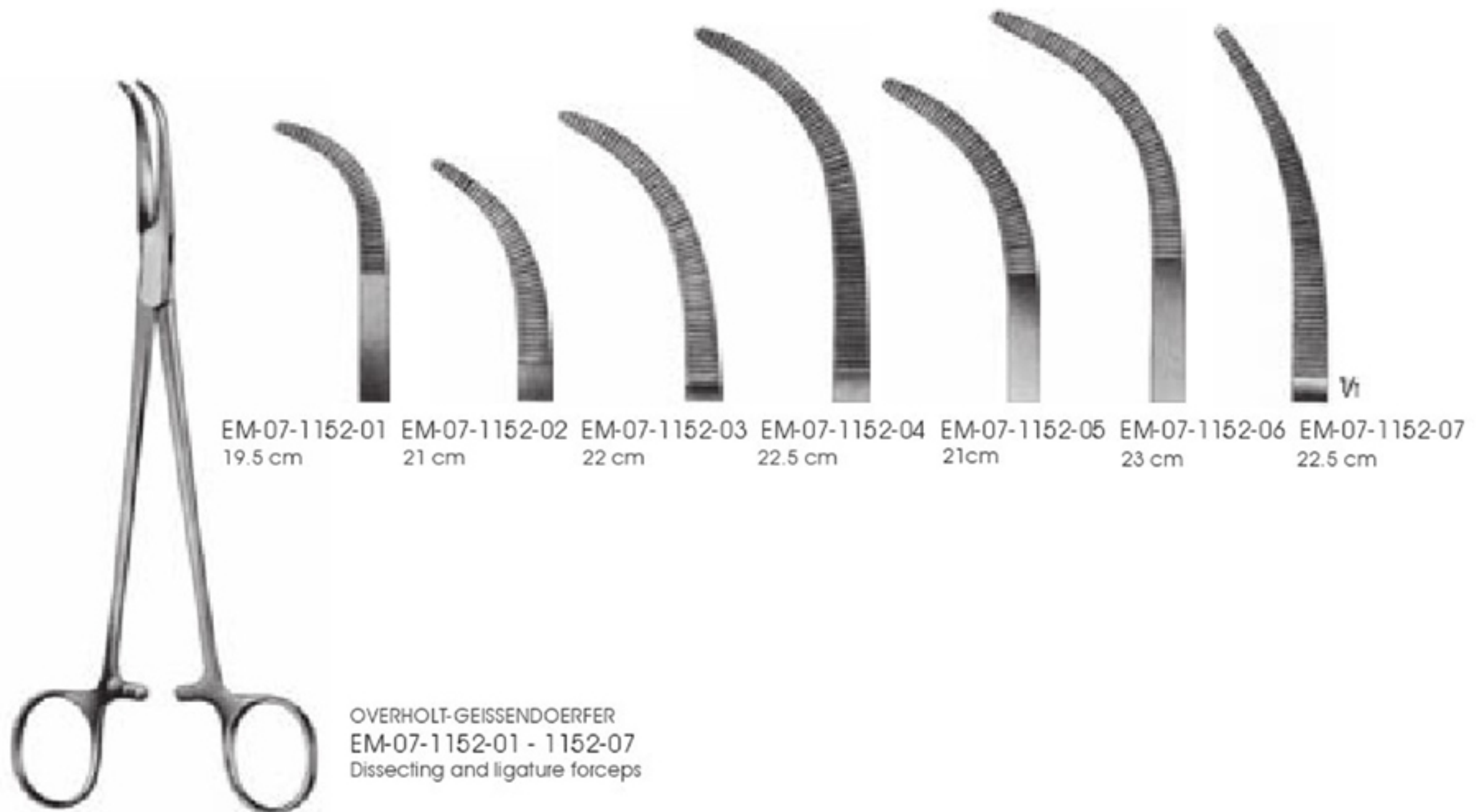



EM-07-1153-01 21.5 cm EM-07-1153-02 21 cm EM-07-1153-03 22 cm EM-07-1153-04 22.5 cm EM-07-1153-05 22.5 cm

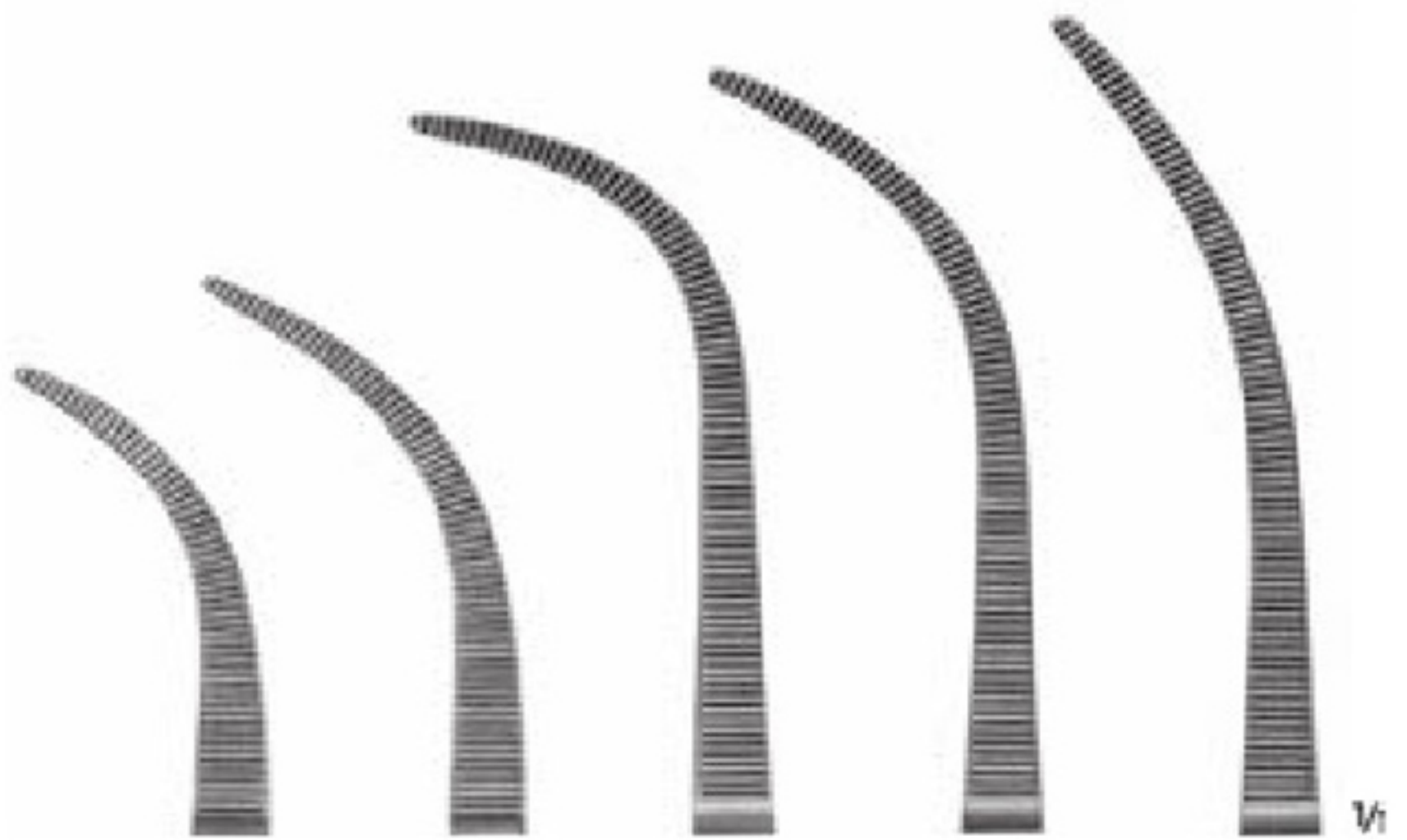

EM-07-1153-06 27 cm EM-07-1153-07 27 cm EM-07-1153-08 29.5 cm EM-07-1153-09 29.5 cm EM-07-1153-10 30 cm



OVERHOLT
EM-07-1153-01 - 1153-10
Delicate pattern



EM-07-1154-01 26 cm EM-07-1154-02 27 cm EM-07-1154-03 27.5 cm EM-07-1154-04 27 cm EM-07-1154-05 28 cm

OVERHOLT-GEISSENDOERFER
EM-07-1154-01 - 1154-05



EM-07-1155-01 13 cm EM-07-1155-02 18 cm EM-07-1155-03 20 cm EM-07-1155-04 23 cm EM-07-1155-05 28 cm

GEMINI
EM-07-1155-01 - 1155-05



EM-07-1156-01
15 cm



EM-07-1156-02
18 cm



EM-07-1156-03
20 cm



EM-07-1156-04
23 cm



EM-07-1156-05
25.5 cm



O'SHAUGHNESSY
EM-07-1156-01 - 1156-05

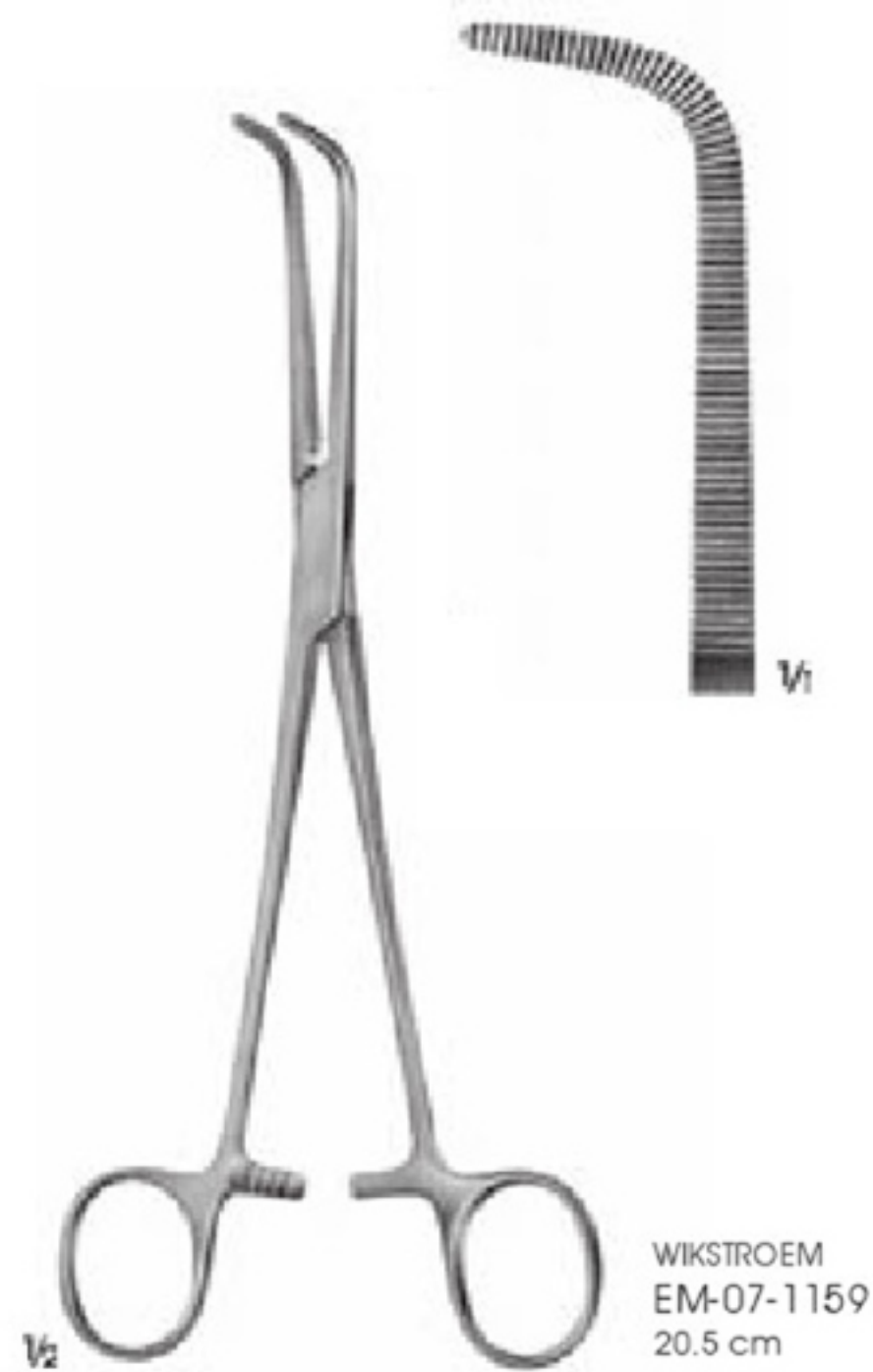



KANTROWITZ
 EM-07-1161-01 - 1161-03



EM-07-1161-01 20 cm
 EM-07-1161-02 24 cm
 EM-07-1161-03 27.5 cm



BARRE
 EM-07-1162-01 - 1162-02
 28 cm



EM-07-1162-01 Extra delicate
 EM-07-1162-02 Delicate



RUMEL
 EM-07-1163-01 - 1163-05
 24 cm



EM-07-1163-01 EM-07-1163-02 EM-07-1163-03 EM-07-1163-04 EM-07-1163-05



ZENKER
EM-07-1164-01 - 1164-05

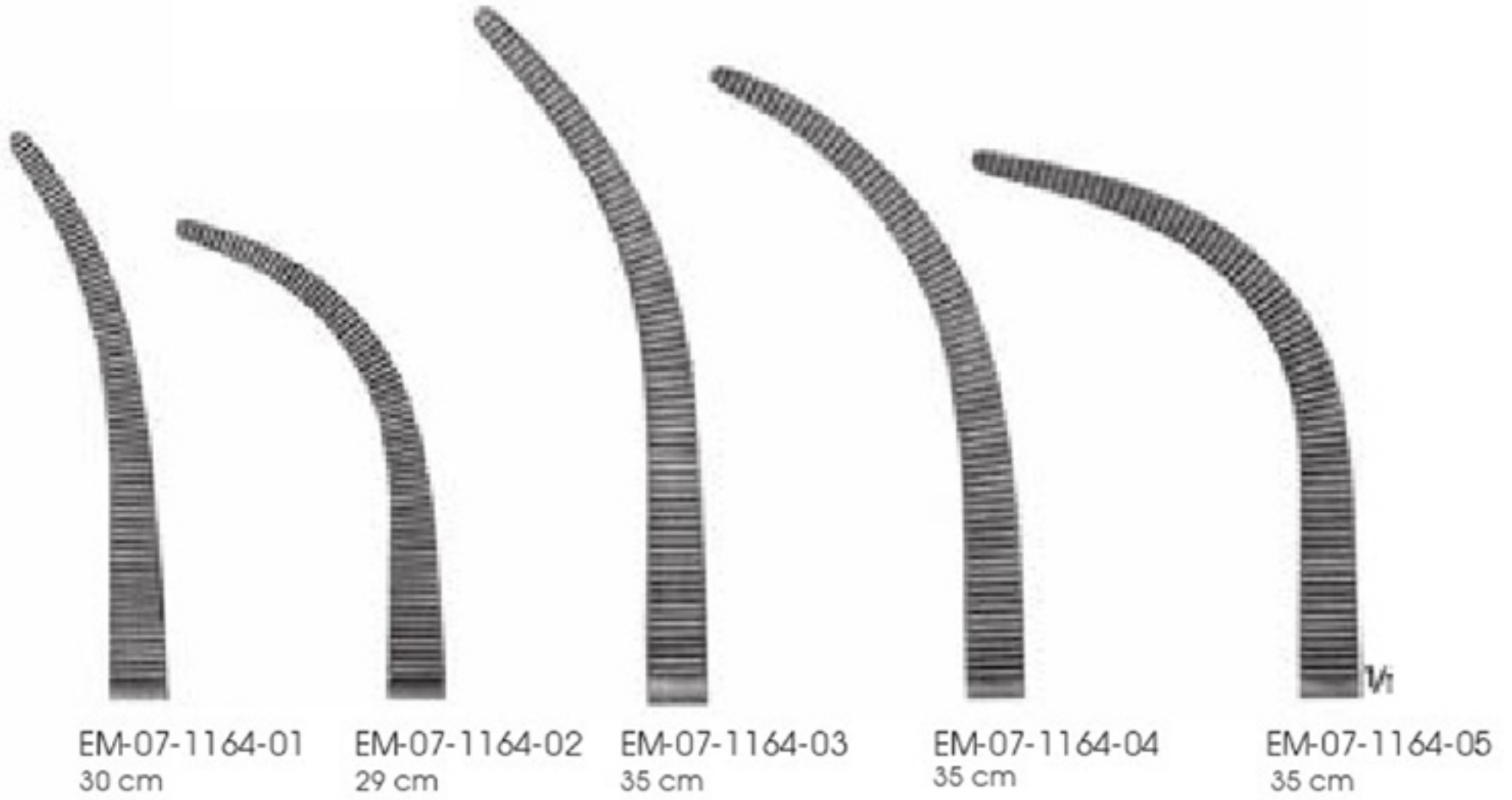



MIXTER
EM-07-1165
23 cm



LAWRENCE
EM-07-1166
27 cm

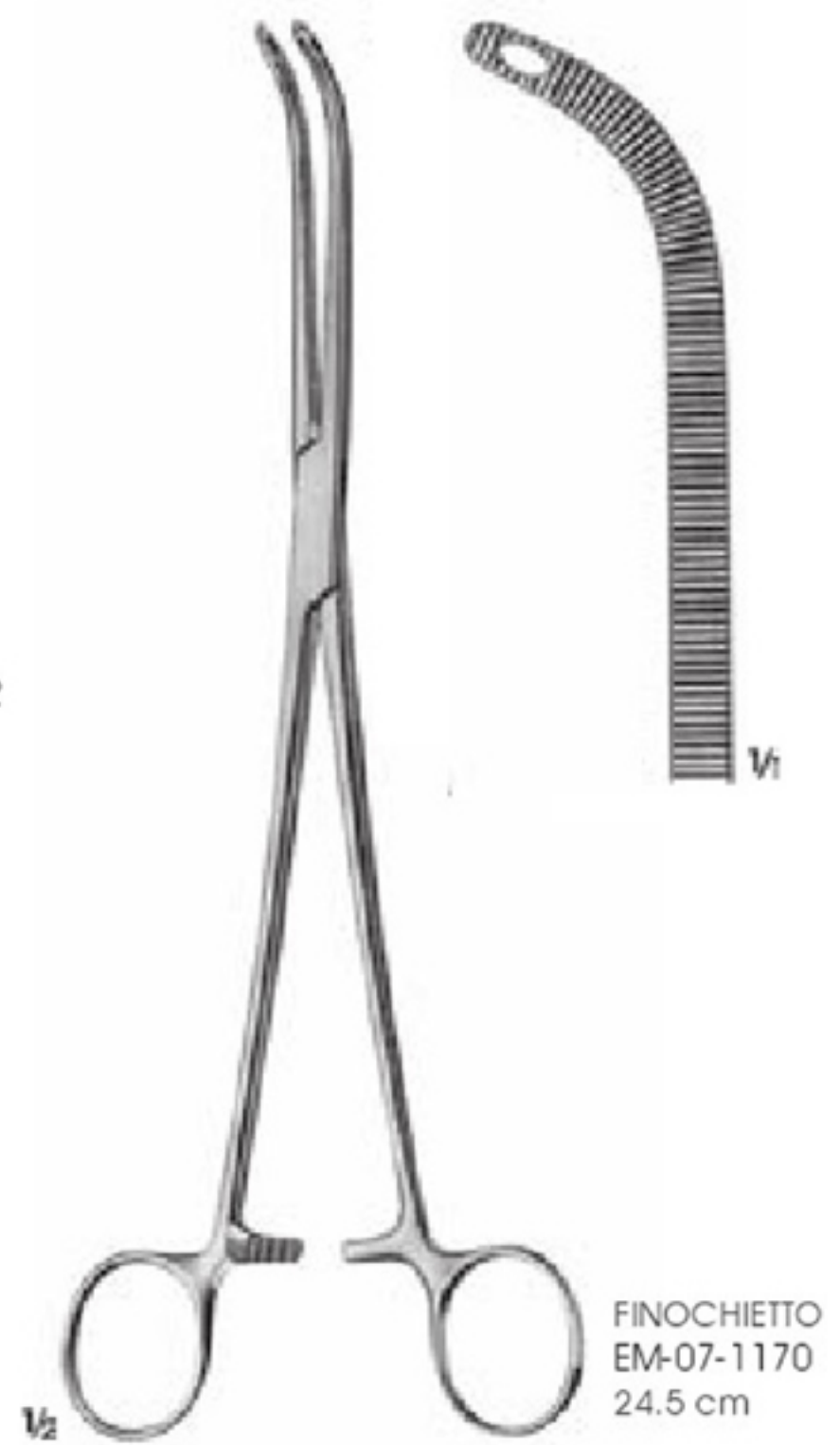
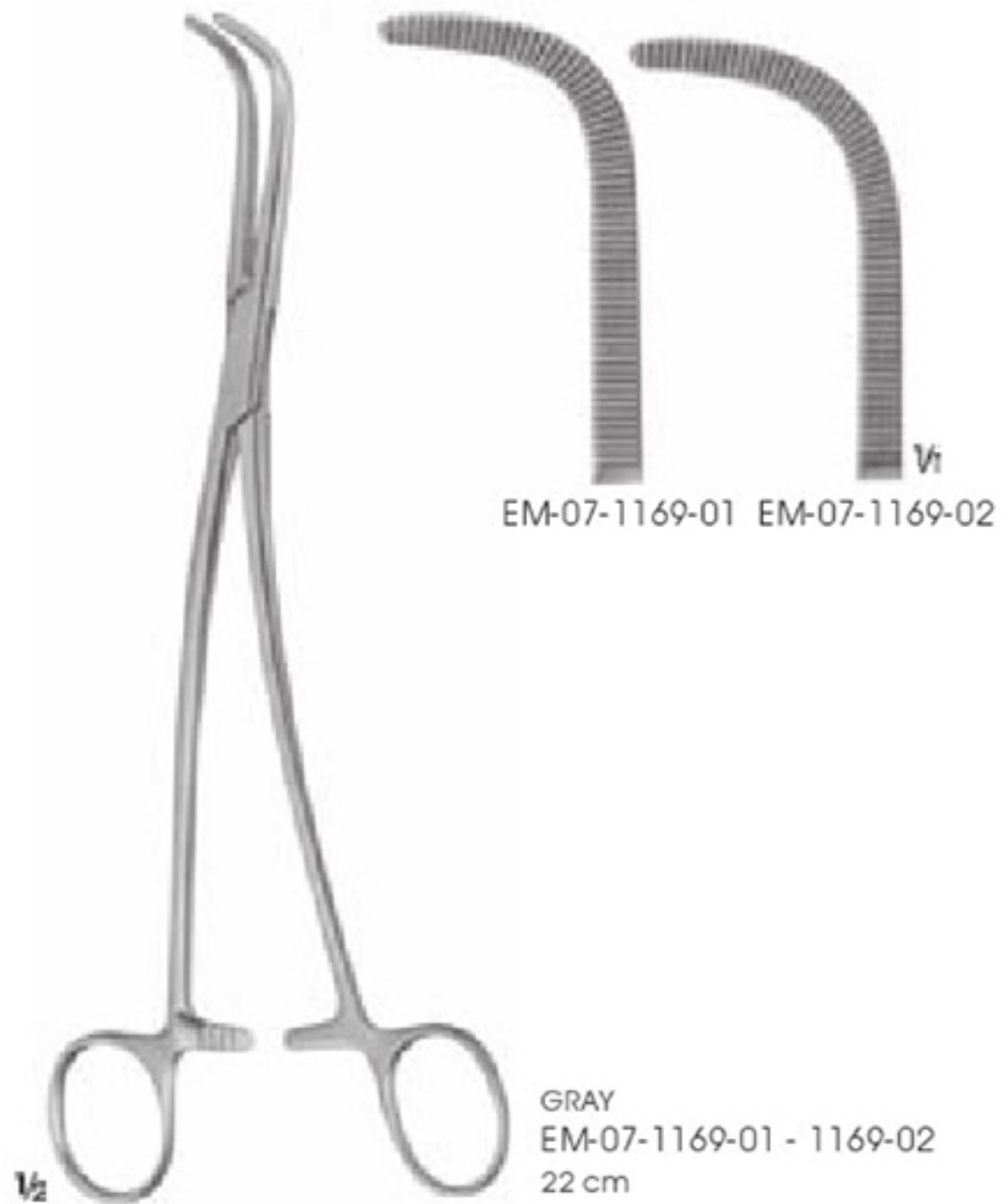





BABY-MIKULICZ
EM-07-1175
14 cm



MIKULICZ
EM-07-1176
18.5 cm



EM-07-1177-01 18 cm
EM-07-1177-02 20.5 cm

MIKULICZ
EM-07-1177-01 - 1177-02

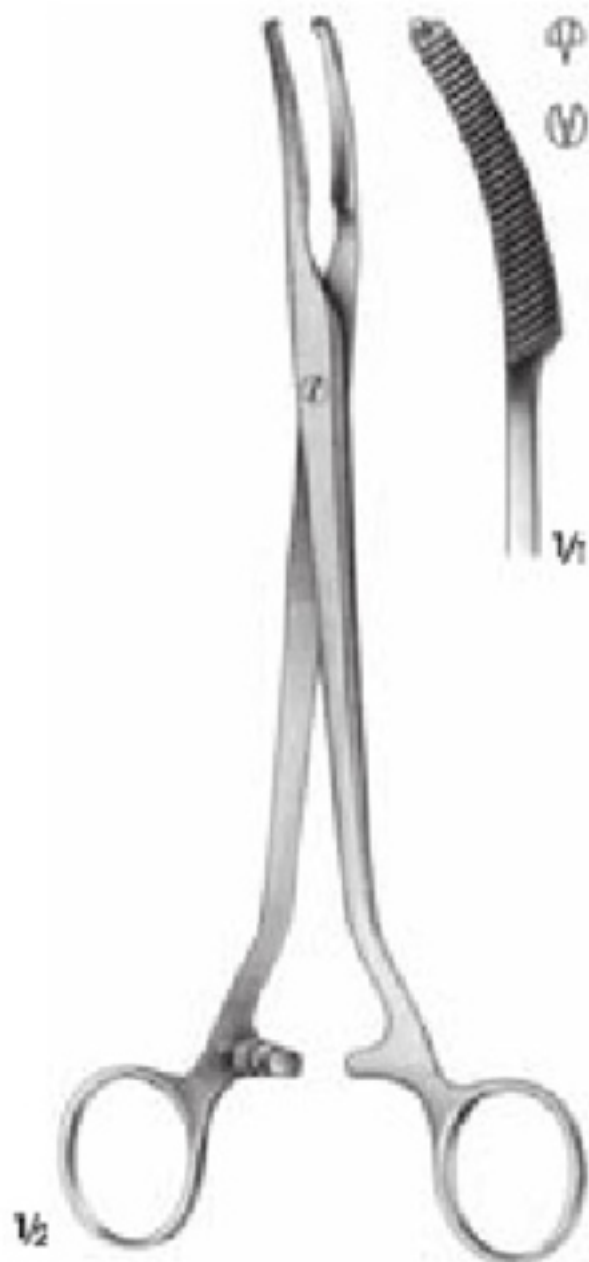

MIKULICZ
EM-07-1178
20.5 cm



MIKULICZ
EM-07-1179
20.5 cm

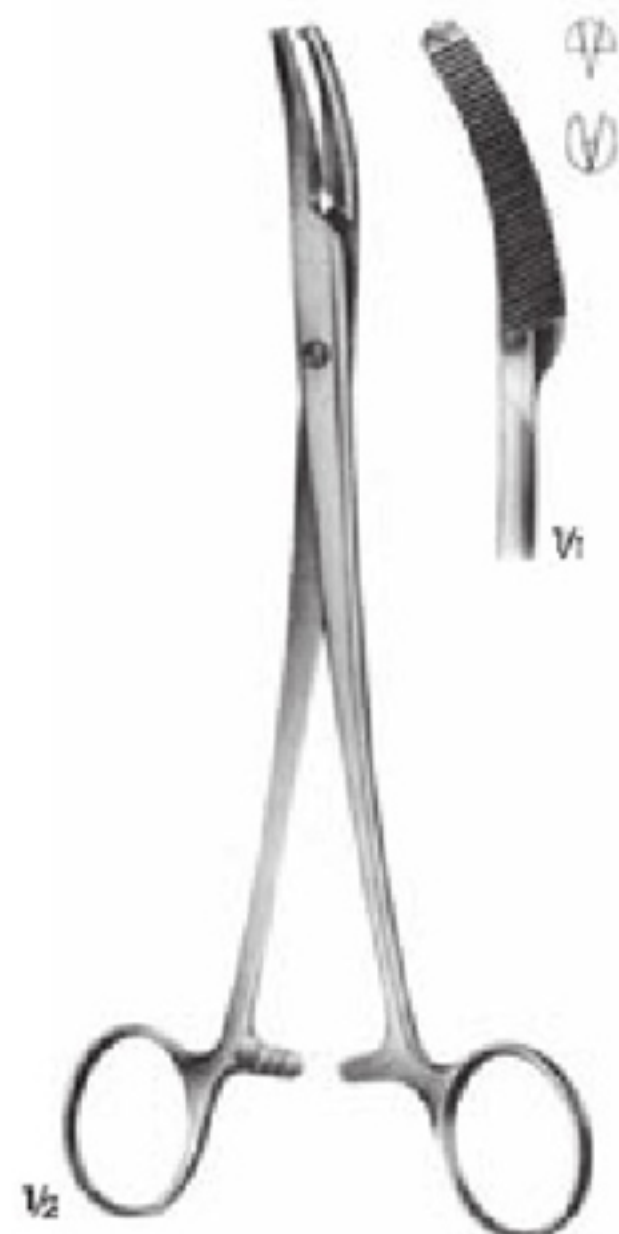

MIKULICZ
EM-07-1180
20 cm

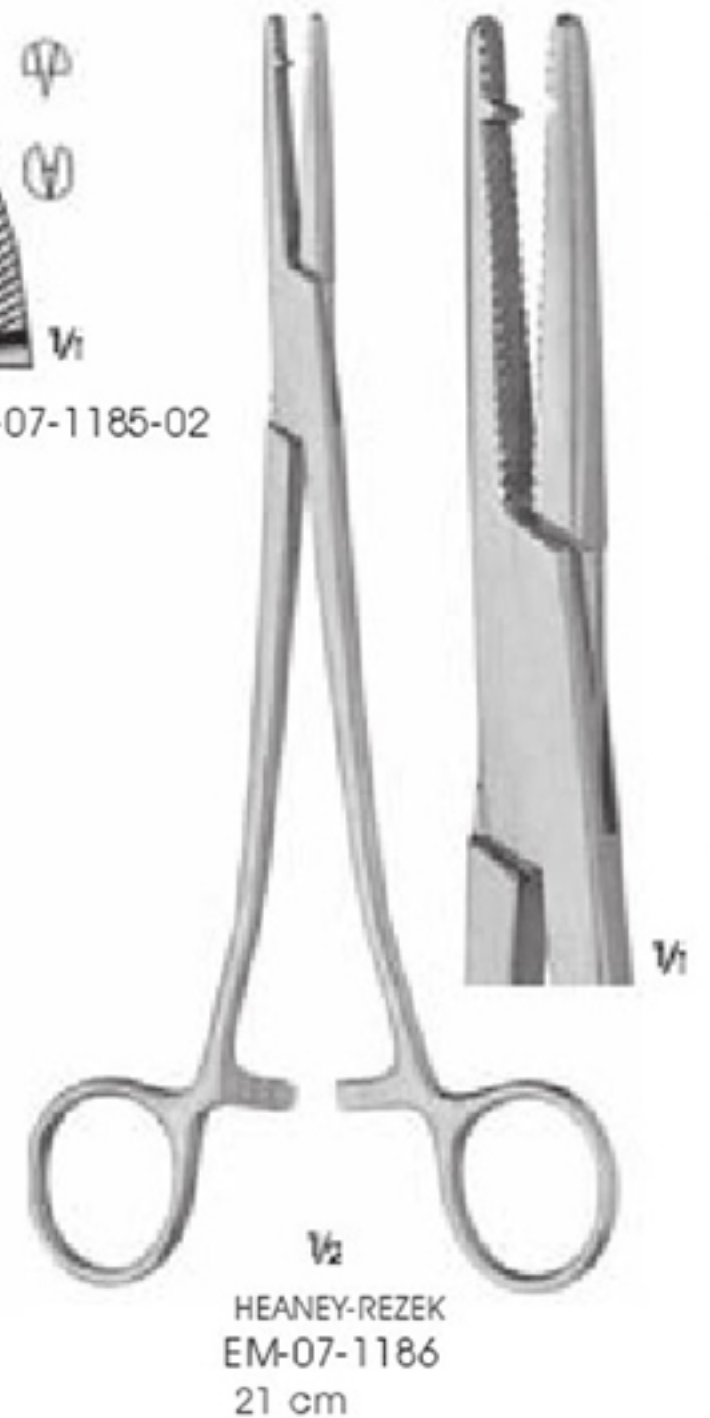
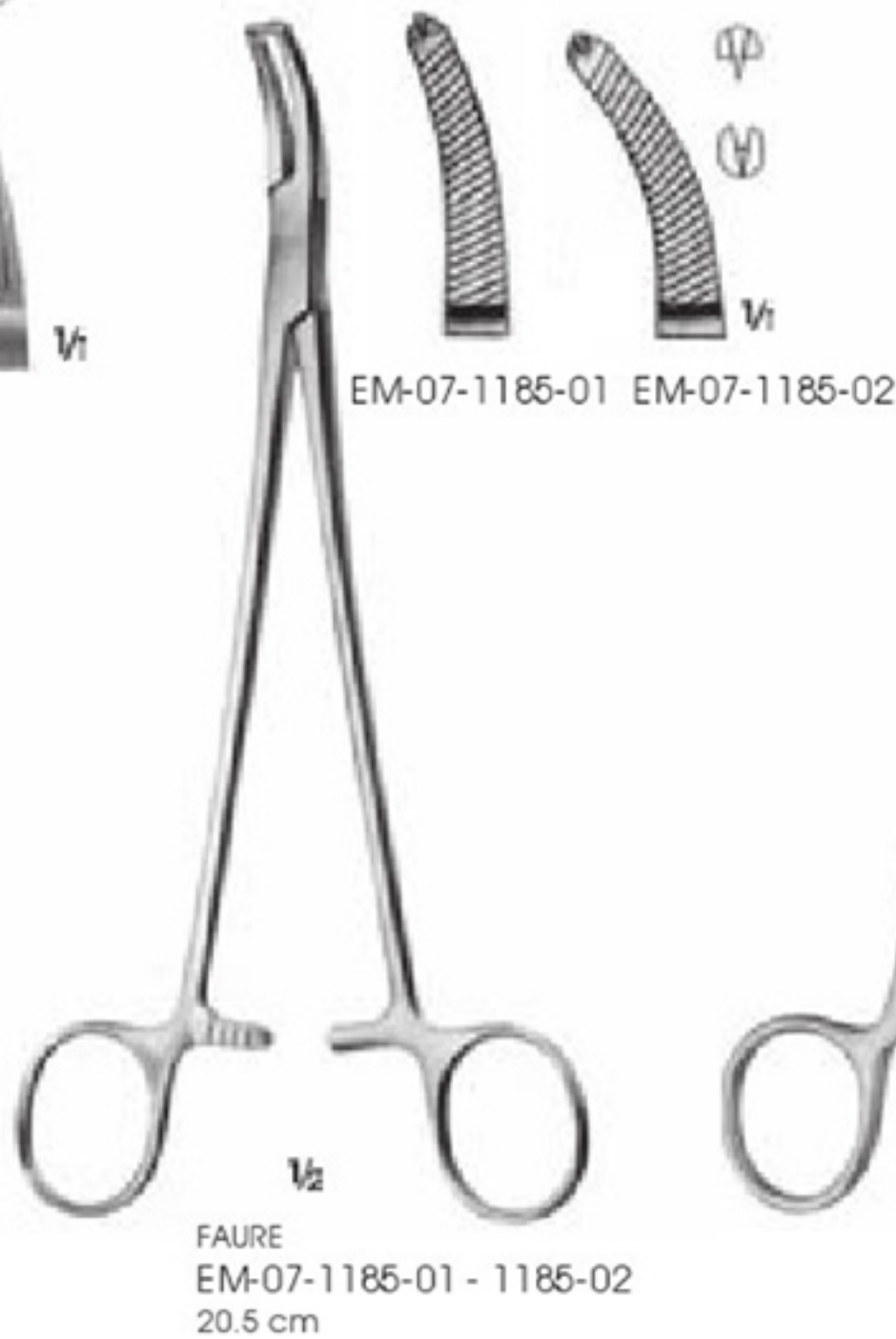

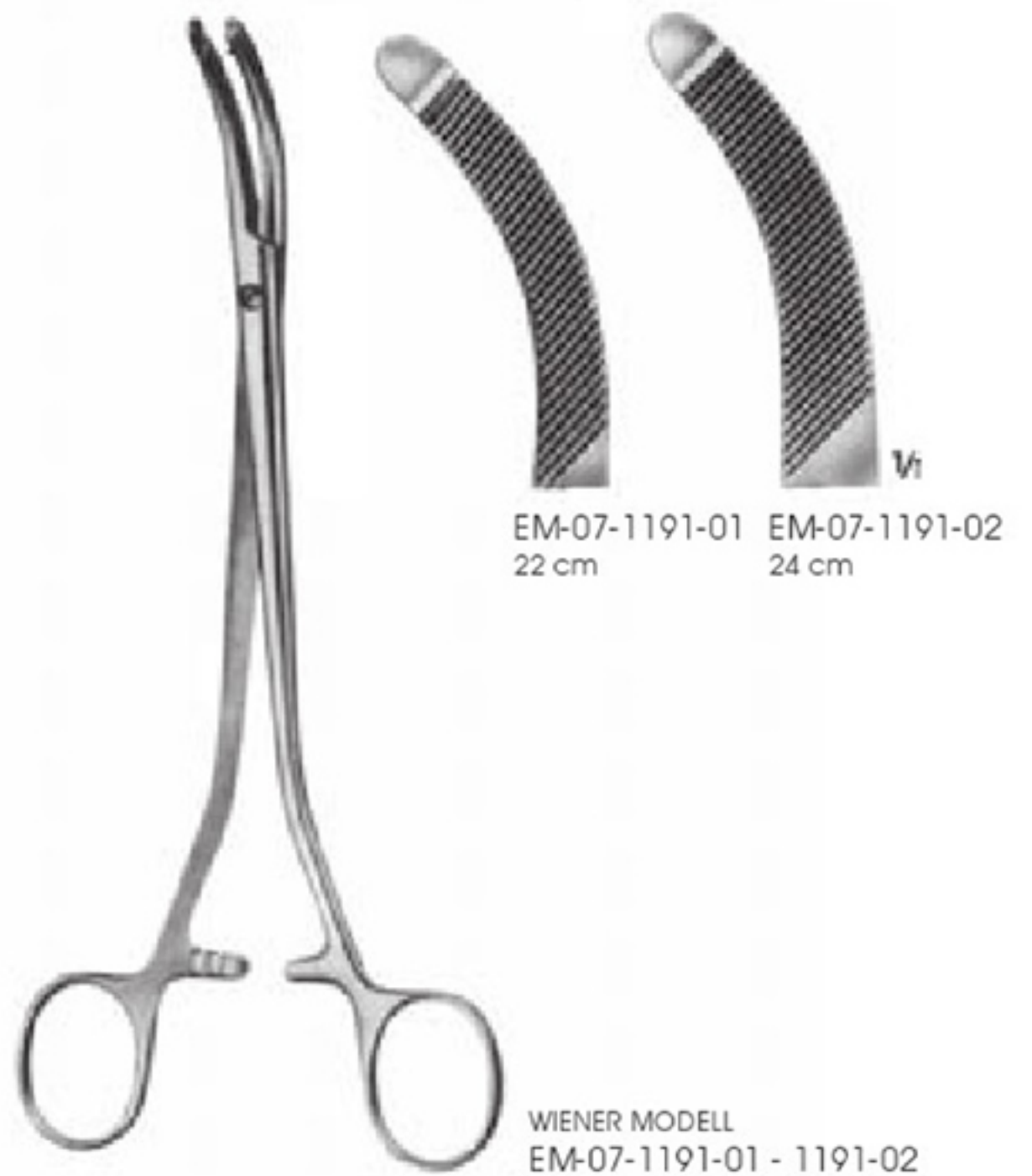

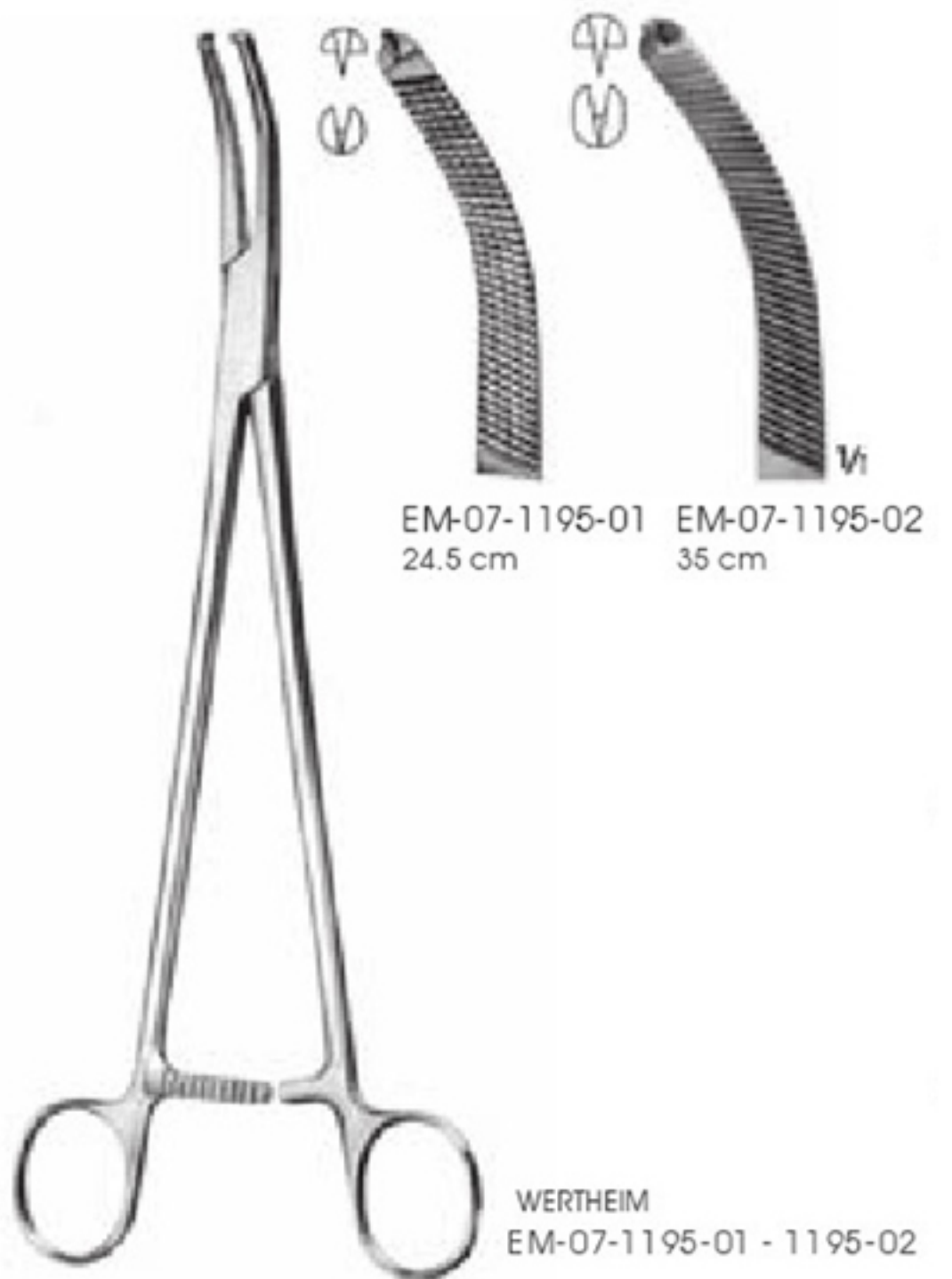
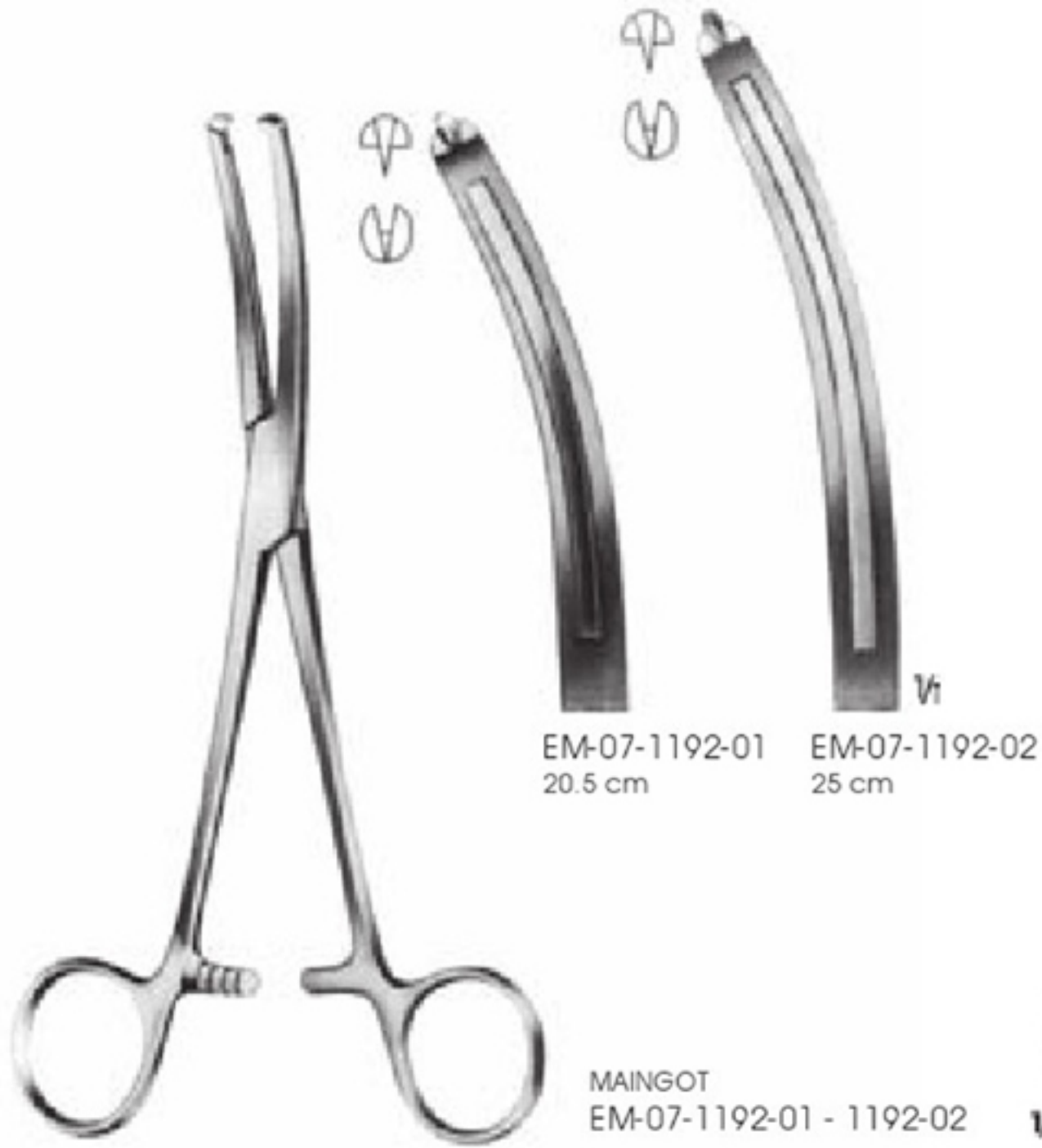



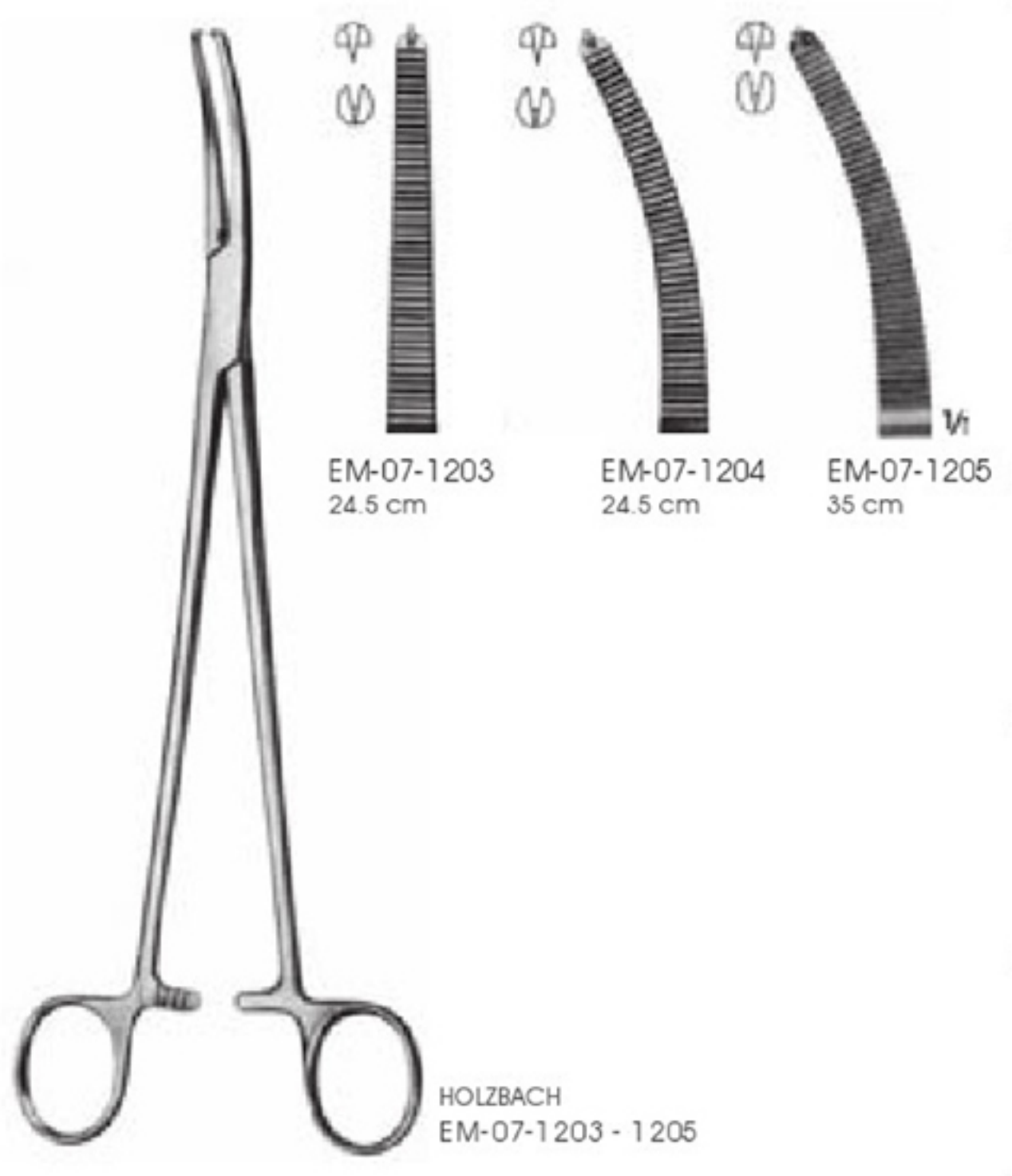
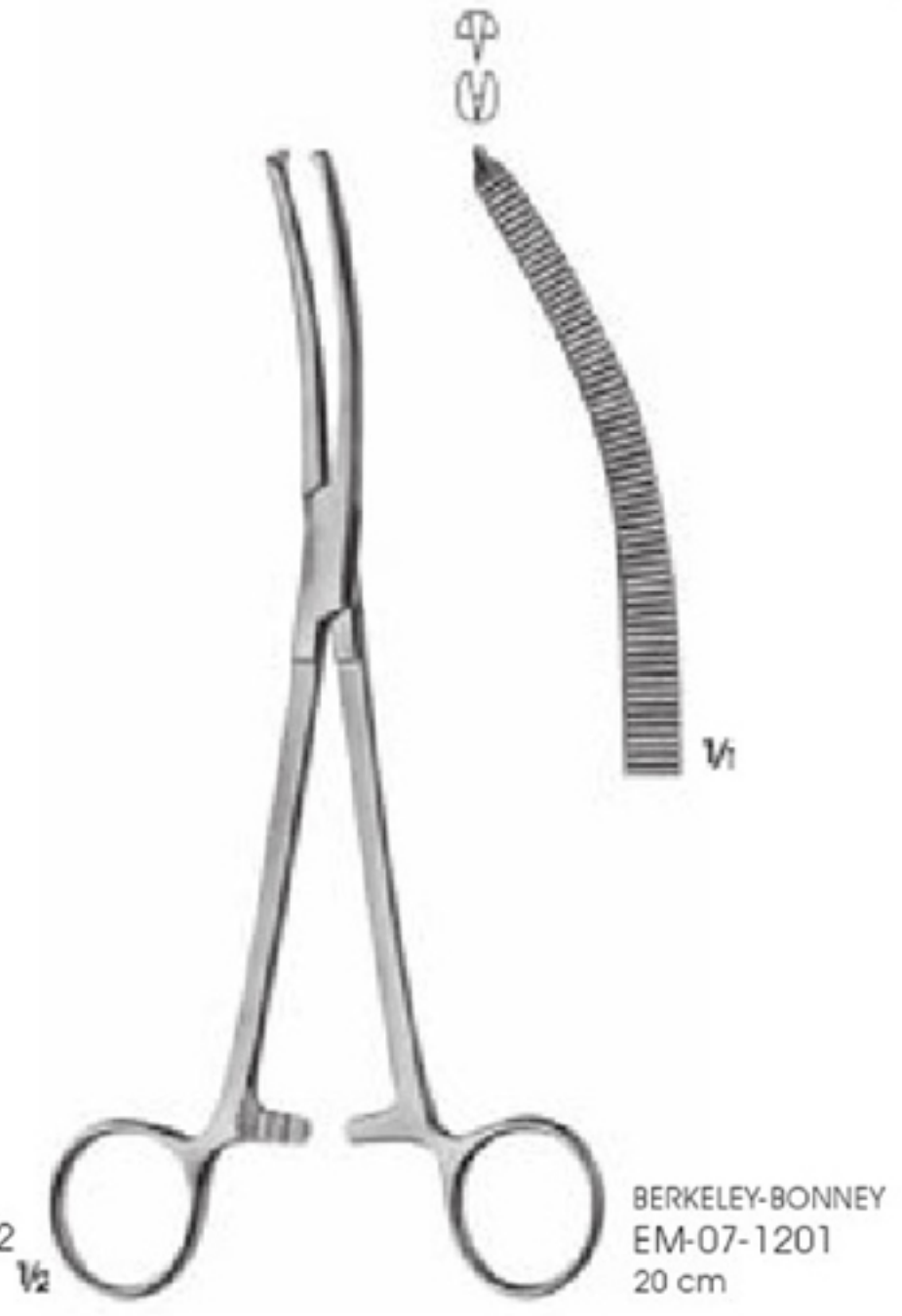



Toothing De BAkey



EM-07-1206
22.5 cm

EM-07-1207
22 cm

EM-07-1208
21.5 cm

EM-07-1209
20.5 cm

HEANEY
EM-07-1206 - 1209



EM-07-1210
25 cm

EM-07-1211
24.5 cm

EM-07-1212
24 cm

EM-07-1213
22 cm

WERTHEIM
EM-07-1210 - 1213



Toothing De BAkey



EM-07-1214-01
25 cm



EM-07-1214-02
35 cm



EM-07-1214-03
25 cm



EM-07-1214-04
35 cm

KIEBACK
EM-07-1214-01 - 1214-04



WERTHEIM
EM-07-1215
25.5 cm



WERTHEIM
EM-07-1216
26 cm

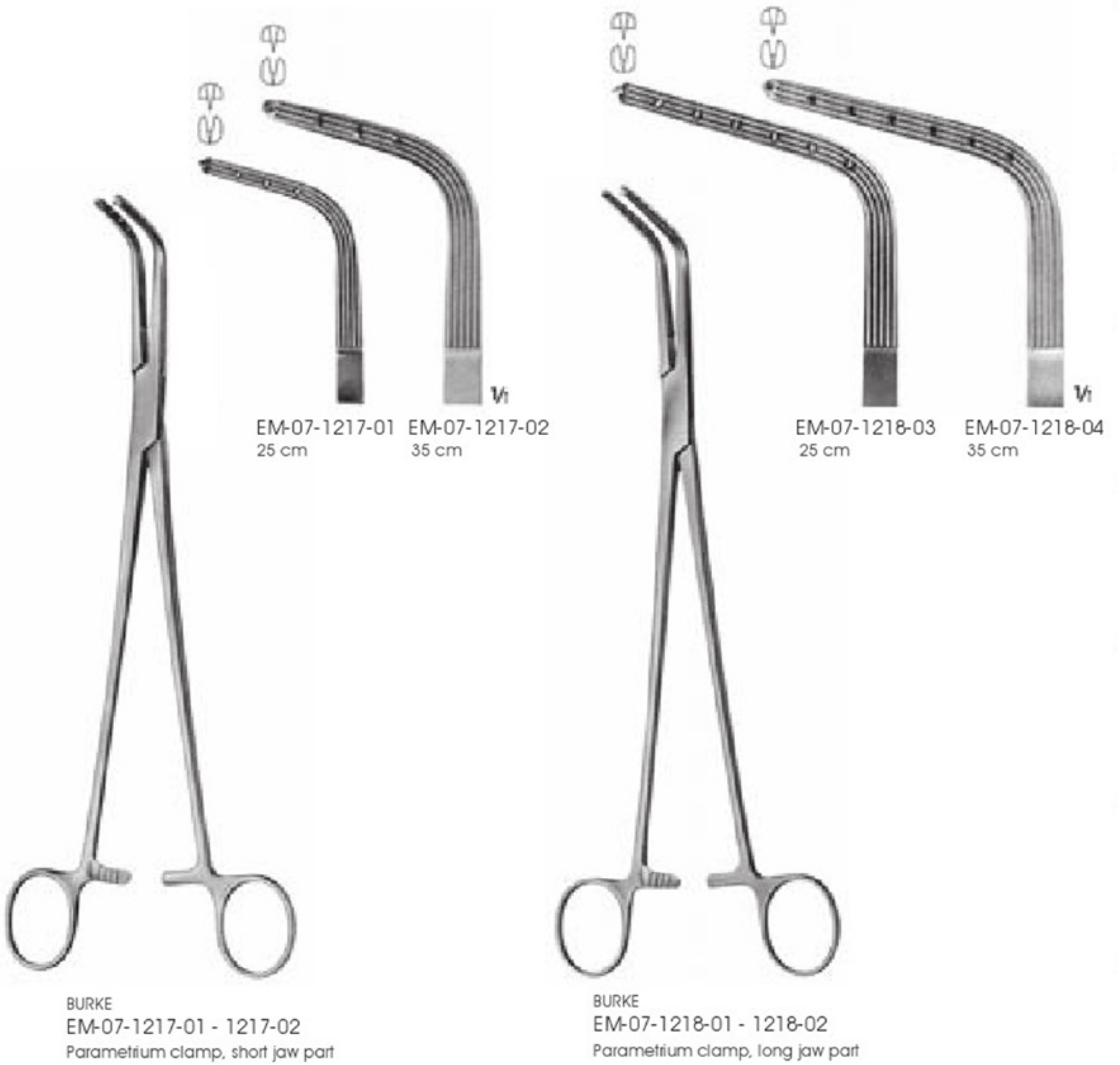

BURKE
EM-07-1217-01 - 1217-02
Parametrium clamp, short jaw part

BURKE
EM-07-1218-01 - 1218-02
Parametrium clamp, long jaw part



Toothing De BAkey

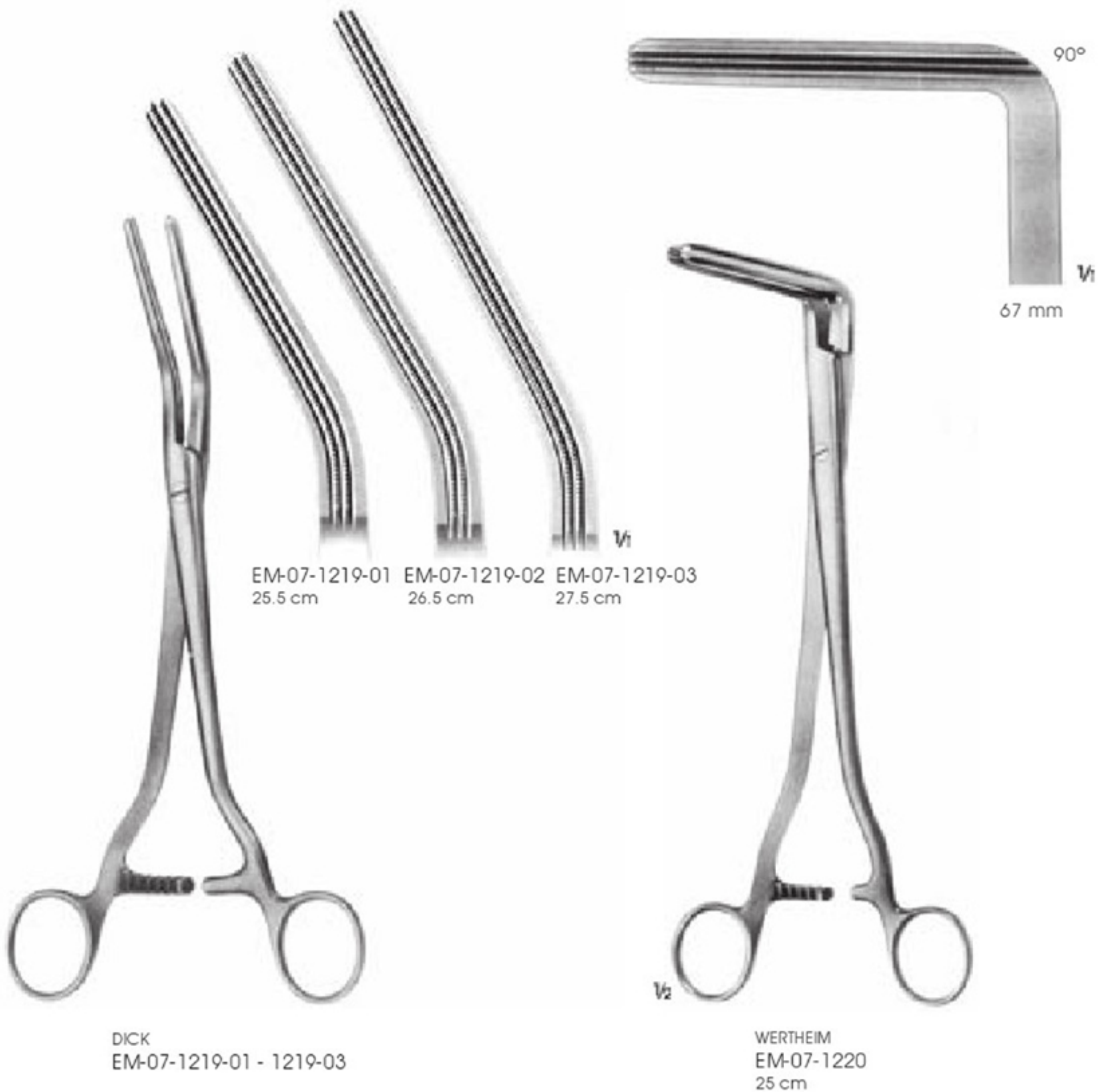



EM-07-1221-01 - 1221-02
23 cm

WERTHEIM-CULLEN
EM-07-1222
21.5 cm